

Products Catalog

Inductors

- For automotive
- For consumer

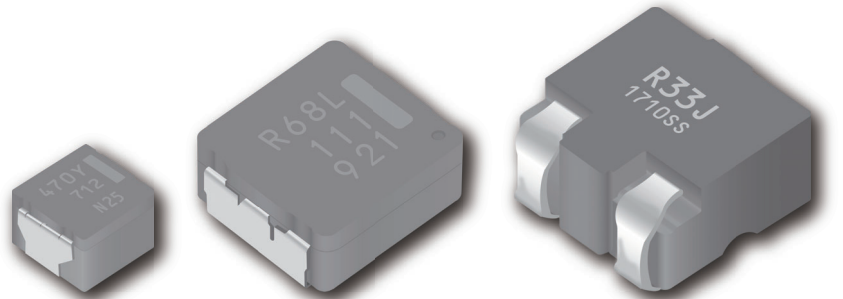

INDUCTORS INDEX

Product item	Type · Series	Part number	Page	
Safety and Legal Matters to Be Observed			1	
Matters to Be Observed When Using This Product (Automotive Grade)			2	
Power Choke Coils (Automotive grade)	M series	PCC-M0530M/M0540M PCC-M0630M/M0645M PCC-M0754M/M0750M PCC-M0854M/M0850M PCC-M1054M/M1050M PCC-M1040ML/M1050ML/M1060ML (MC)	ETQ P3M□□□Y□□ ETQ P4M□□□Y□□ ETQ P5M□□□Y□□ ETQ P6M□□□YLC/KLC	4
	MS series	PCC-M0854MS/M1050MS (MC)	ETQ P5M□□□YSK ETQ P5M□□□YSC	21
	MF series	PCC-M1280MF/M15A0MF (MC)	ETQ P8M□□□JFA ETQ PAM□□□JFW	25
	LP series	PCC-M0530M-LP/M0630M-LP PCC-M0840M-LP/M1040M-LP (MC)	ETQ P3M□□□KV□ ETQ P4M□□□KV□	33
	LE series	PCC-M0648M-LE PCC-M0748M-LE (MC)	ETQ P4M□□□KFN ETQ P4M□□□KFM	45
	LL series	PCC-M0750M-LL (Development product)	ETQP5M□□□CVM	52
	H series	PCC-M0530M-H PCC-M0630M-H (MC)	ETQ P3M□□□HF□	56
		PCC-D1413H (DUST)	ETQ PDH240DTV	61
	Soldering conditions (Automotive Grade)			64
Matters to Be Observed When Using This Product (Consumer use)			65	
Power Choke Coils (Consumer use)		PCC-M0730L (MC)	ETQ P3L	66
		PCC-M0740L (MC) Low DCR type	ETQ P4L	68
		PCC-M1040L (MC)	ETQ P4L	70
		PCC-M1040L (MC) Low DCR type	ETQ P4L	72
		PCC-M1250L (MC)	ETQ P5L	74
	Soldering conditions (Consumer use)			76
	Packaging methods (Consumer use)			77

Safety and Legal Matters to Be Observed

Product specifications and applications

- Please be advised that this product and product specifications are subject to change without notice for improvement purposes. Therefore, please request and confirm the latest delivery specifications that explain the specifications in detail before the final design, or purchase or use of the product, regardless of the application. In addition, do not use this product in any way that deviates from the contents of the company's delivery specifications.
- Unless otherwise specified in this catalog or the product specifications, this product is intended for use in general electronic equipment (AV products, home appliances, commercial equipment, office equipment, information and communication equipment, etc.).
When this product is used for the following special cases, the specification document suited to each application shall be signed/sealed (with Panasonic Industry and the user) in advance..These include applications requiring special quality and reliability, wherein their failures or malfunctions may directly threaten human life or cause harm to the human body (e.g.: space/aircraft equipment, transportation/traffic equipment, combustion equipment, medical equipment, disaster prevention/crime prevention equipment, safety equipment, etc.).

Safety design and product evaluation

- Please ensure safety through protection circuits, redundant circuits, etc., in the customer's system design so that a defect in our company's product will not endanger human life or cause other serious damage.
- This catalog shows the quality and performance of individual parts. The durability of parts varies depending on the usage environment and conditions. Therefore, please ensure to evaluate and confirm the state of each part after it has been mounted in your product in the actual operating environment before use.
If you have any doubts about the safety of this product, then please notify us immediately, and be sure to conduct a technical review including the above protection circuits and redundant circuits at your company.

Laws / Regulations / Intellectual property

- The transportation of dangerous goods as designated by UN numbers, UN classifications, etc., does not apply to this product. In addition, when exporting products, product specifications, and technical information described in this catalog, please comply with the laws and regulations of the countries to which the products are exported, especially those concerning security export control.
- Each model of this product complies with the RoHS Directive (Restriction of the use of hazardous substances in electrical and electronic equipment) (2011/65/EU and (EU) 2015/863). The date of compliance with the RoHS Directive and REACH Regulation varies depending on the product model.
Further, if you are using product models in stock and are not sure whether or not they comply with the RoHS Directive or REACH Regulation, please contact us by selecting "Sales Inquiry" from the inquiry form.
- During the manufacturing process of this product and any of its components and materials to be used, Panasonic Industry does not intentionally use ozone-depleting substances stipulated in the Montreal Protocol and specific bromine-based flame retardants such as PBBs (Poly-Brominated Biphenyls) / PBDEs (Poly-Brominated Diphenyl Ethers). In addition, the materials used in this product are all listed as existing chemical substances based on the Act on the Regulation of Manufacture and Evaluation of Chemical Substances.
- With regard to the disposal of this product, please confirm the disposal method in each country and region where it is incorporated into your company's product and used.
- The technical information contained in this catalog is intended to show only typical operation and application circuit examples of this product. This catalog does not guarantee that such information does not infringe upon the intellectual property rights of Panasonic Industry or any third party, nor imply that the license of such rights has been granted.
- Design, materials, or process related to technical owned by Panasonic Industry are subject to change without notice.

Panasonic Industry will assume no liability whatsoever if the use of our company's products deviates from the contents of this catalog or does not comply with the precautions. Please be advised of these restrictions.

Matters to Be Observed When Using This Product

(Power inductor for Automotive)

Use environments and cleaning conditions

- This product (inductor) is intended for standard general-purpose use in electronic equipment, and is not designed for use in the specific environments described below. Using the product in such specific environments or service conditions, therefore, may affect the performance of the product.
Please check with us about the performance and reliability of the product first before using the product.
 - (1) A product splashed with water, coffee, etc., is in a wet state.
 - (2) Used in a place where the product is heavily exposed to sea breeze or a corrosive gas, such as Cl₂, H₂S, NH₃, SO₂, or NO_x.
 - (3) Used in an outdoor environment where the product is exposed to direct sunlight, ozone, radiation, UV-rays, etc., or in a dusty place.
- Sealing the product with a resin may damage the copper wire insulation cover of the product. In such a case, consult us first.
- Immersing the product in a solvent, cleaning agent, or coating agent containing toluene or xylene for a long period may result in a significant drop in the performance of the product. In such a case, consult us first.

Response to anomalies and handling conditions

- The inductor, as a single component, does not have a protective function against a problem such as overloading, short circuit, or open failure. Make sure to provide a circuit set with a protection device or circuit that protects the inductor, and confirm that smoke generation/ignition, weakened dielectric strength, lower insulation resistance, etc., do not occur.
- The temperature rise rate of the inductor changes depending on the state in which the inductor is incorporated in the circuit set. Make sure to confirm that the temperature of the inductor is equal to or lower than the temperature corresponding to the specified insulation class (heat-resistant class) when the inductor is incorporated in the circuit set.
- Applying voltage higher than the specified withstand voltage to the inductor at a dielectric strength test leads to the deterioration of the insulation performance of the inductor. Be careful to avoid this.
- Handle the inductor while protecting it from static electricity with proper electrostatic control measures.
(Process/equipment) Applying voltage equal to or higher than 200 V to the inductor may change its characteristics. Keep voltage applied to the inductor lower than 200 V.
- The inductor having received mechanical stress as a result of dropping on the floor, etc., may have formed a crack on its core, etc., and therefore the performance of the inductor may have dropped significantly. Avoid using such an inductor.
- When severe mechanical stress is applied to an inductor, its core may chip or crack.
There are also some cases where the core already has a chipped or cracked part. However, this chip or crack is negligible and has no effect on the quality of the inductor.

Reliability and product life

A product conforming to "AEC-Q200" refers to a product having passed some or all of the evaluation test items defined in AEC-Q200. To know the detailed specifications of individual products or specific evaluation test scores, please contact us. We issue a delivery specification sheet for each product ordered. Please confirm with the sheet when you place an order with us.

Circuit design and circuit board design

- When the inductor is used in a different product set among a series of similar product sets, there are times when the inductor will fail to achieve 100% of its capability because of the difference in service conditions, etc. In such a case, consult us first.
- When the inductor is used in an audible frequency range (= about 20 Hz to 20 kHz) or burst mode, it may emit a sound (beat) under certain operation conditions (current waveform conditions). This sound may be heard as noise, depending on circuits/board configurations in which the inductor is incorporated. Check for this problem before using the inductor.
- When there is a possibility that electrostatic noise is applied to circuit components, place an ESD preventing component, such as a capacitor resistant to static electricity, in a preceding stage to the inductor. In such a case, consult us first.
- To ensure insulation between the internal coil of the inductor and the upper surface of the board, avoid forming patterns or vias in which voltage exceeding the guaranteed operating voltage is applied, on the uppermost layer of the board in counter to the inductor bottom. (DUST series)
- Do not form a pattern, via, etc., on the counter to the bottom of the inductor. (MC series/* Fig.1, Dust type/*Fig.2)
- Keep a component placed around the inductor from being in contact with the surface (top face, side face) of the inductor. (MC series/* Fig. 3)
- Different from a ferrite core type with a magnetic energy concentration gap, the inductor described herein has a vertical leakage flux distribution.
Exercise special caution when using a component or a circuit configuration susceptible to leakage flux from an inductor.

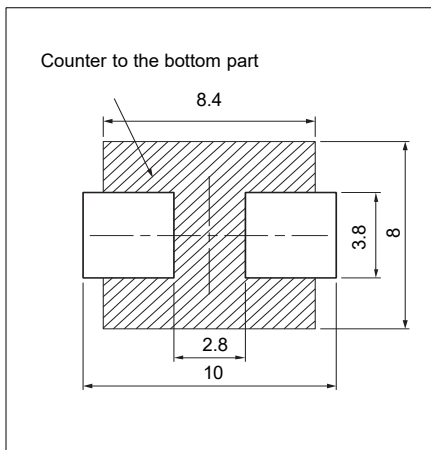

Fig.1

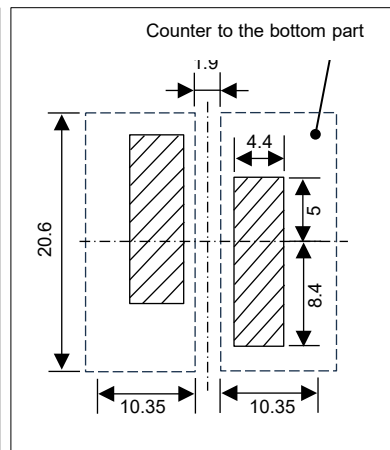

Fig.2

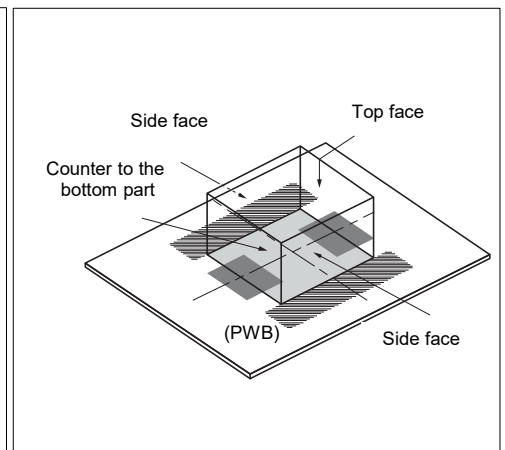

Fig.3

Reference information

Labeling on package

On the inductor package, a product number, the number of components, and the place of origin are indicated. Usually, the place of origin is written in English.

Power Inductors

Power Choke Coil (Automotive Grade)

PCC-M0530M, M0540M, M0630M, M0645M series

PCC-M0754M, M0750M, M0854M, M0850M series

PCC-M1054M, M1050M, M1040ML, M1050ML, M1060ML series

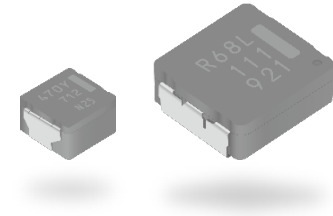

High heat resistance and high reliability using metal composite core (MC)

Industrial property : Patents 21 (Registered 2 / Pending 19)

Features

- High heat resistance
: Operation up to 150 °C including self-heating. (180 °C short time*)
* Please contact for possible to use over 150 °C condition. Temperature up to 180 °C may possibly be used.
- High-reliability :
: High vibration resistance as result of newly developed integral construction; under severe reliability conditions of automotive and other strenuous applications
- High bias current
: Excellent inductance stability using ferrous alloy magnetic material (Fig.1)
- Temp. stability
: Excellent inductance stability over broad temp. range (Fig.1)
- Low audible (buzz) noise
: A gapless structure achieved with metal composite core
- High efficiency
: Low DC resistance of winding and low eddy-current loss of the core
- Shielded construction
- AEC-Q200 compliant
- RoHS compliant

(Fig.1)
Inductance v.s. DC current, Temp.
ETQP5M470YFM (reference)

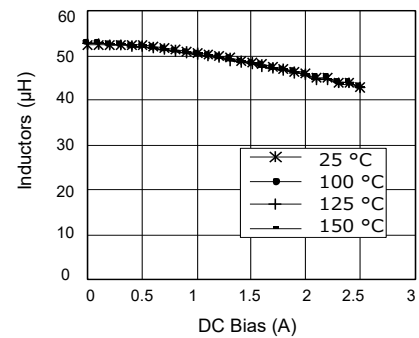

Recommended applications

- Noise filter for various drive circuitry requiring high temp. operation and peak current handling capability
- Boost-Converter, Buck-Converter DC/DC

Standard packing quantity (Minimum quantity/Packing unit)

- 1,000 pcs/box (2 reel) : PCC - M0645M, M0754M, M0750M, M0854M, M0850M, M1054M, M1050M, M1040ML, M1050ML, M1060ML
- 2,000 pcs/box (2 reel) : PCC - M0530M, M0540M, M0630M

Explanation of part numbers

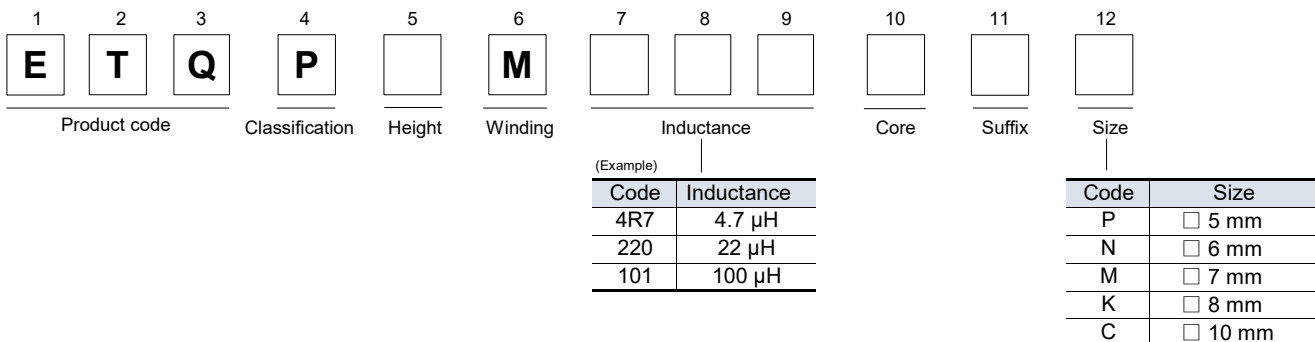

Temperature rating

Operating temperature range		Tc : -40 °C to +150 °C (Including self-temperature rise)
Storage condition	After PWB mounting	
	Before PWB mounting	Ta : -5 °C to +35 °C 85%RH max.

1. PCC-M0530M / PCC-M0540M series (ETQP3M□□□YFP / ETQP4M□□□YFP)

Standard parts

Part No.	Inductance *1		DCR (at 20 °C) (mΩ)		Rated current (A) Typ.		Vibration resistance (G)	MSL	Series [Size L×W×H] (mm)
	L0 (μH)	Tolerance (%)	Typ. (max.)	Tolerance (%)	$\Delta T = 40 \text{ K}^{*2}$ () ^{*3}	$\Delta L =$ -30 % ^{*4}	*5	*6	
ETQP3M2R2YFP	2.2	±20	22.6 (24.8)	±10	5.8 (4.8)	10.8	10	1	PCC-M0530M [5.0×5.5×3.0]
ETQP3M3R3YFP	3.3		31.3 (34.4)		5.0 (4.0)	8.6			
ETQP4M4R7YFP	4.6		36.0 (39.6)		4.8 (4.0)	7.7			
ETQP4M220YFP	22.0		163.0 (179.0)		2.3 (1.9)	3.1			

*1: Measured at 100 kHz

*2: The proved current value for making the overall temperature rise of 40K, when mounted on a multi-layer board with high-heat dissipation (heat dissipation constant 5.5x5.0x3.0 mm : approx. 52 K/W, 5.5x5.0x4.0 mm : approx. 48 K/W).

*3: The proved current value for making the overall temperature rise of 40K, when mounted on a 4-layer circuit board of FR4 t=1.6 mm and DC current is applied.

*4: Saturation rated current : DC current which causes L(0) drop -30 %.

*5: Vibration resistance conditions : Amplitude: 5 mm or less, sweep speed: 1 oct / min, frequency 5-2000 Hz, 3 directions/2 hours each, total 6 hours

*6: The solderability is guaranteed for 1 year only. The product out of expiration date shall not be used.

◆ Within a suitable application, the part's temperature depends on circuit design and certain heat dissipation conditions. This should be double checked in a worst case operation mode. In normal case, the max.standard operating temperature of +150°C should not be exceeded. Please contact for possible to use over 150 °C condition. Temperature up to 180 °C may possibly be used.

Performance characteristics (Reference①)

● Inductance vs DC Current

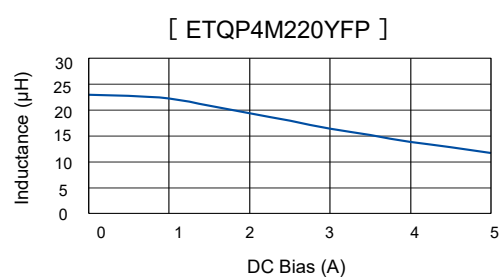
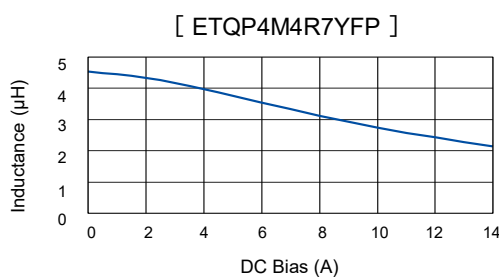
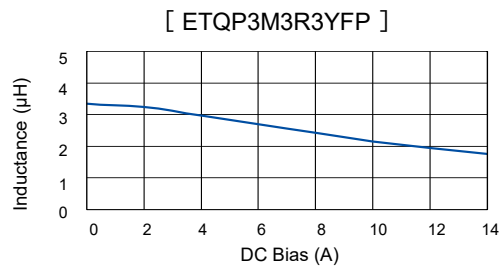
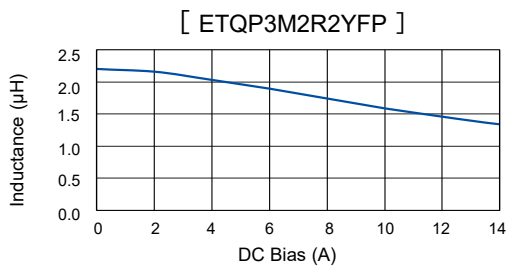

Performance characteristics (Reference②)

● Case Temperature vs DC Current

- PWB condition A : Four-layer PWB (1.6 mm FR4).^{*3}
- - - PWB condition B : Multilayer PWB with high heat dissipation performance.^{*2}

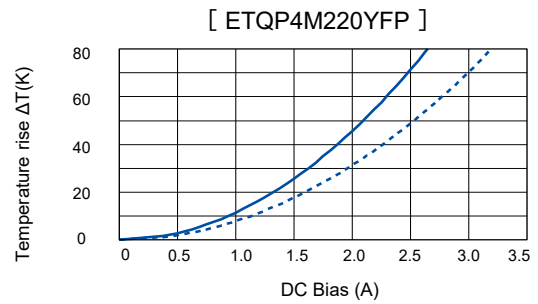
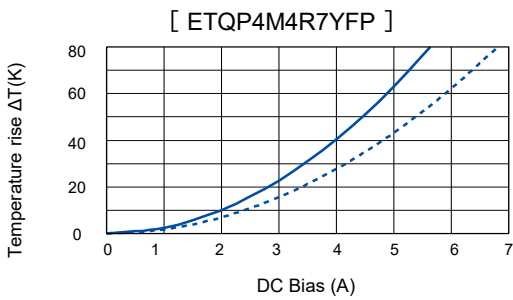
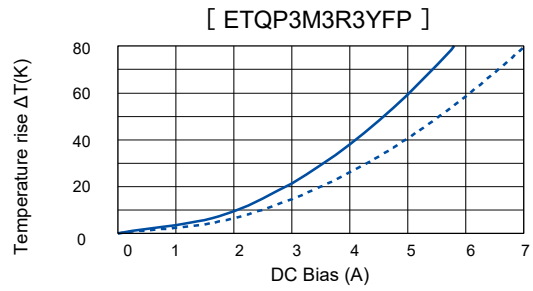
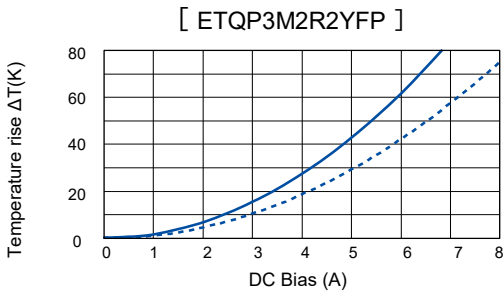

2. PCC-M0630M / PCC-M0645M series (ETQP3M□□□YFN / ETQP4M□□□YFN)

Standard parts

Part No.	Inductance *1		DCR (at 20 °C) (mΩ)		Rated current (A) Typ.		Vibration resistance (G) *5	MSL *6	Series [Size L×W×H] (mm)
	L0 (μH)	Tolerance (%)	Typ. (max.)	Tolerance (%)	$\Delta T = 40 \text{ K}^{*2}$ () ^{*3}	$\Delta L =$ -30 % ^{*4}			
ETQP3MR68YFN	0.68	±20	6.3 (6.90)	±10	12.0 (9.8)	24.0	10.0	1	PCC-M0630M [6.0×6.5×3.0]
ETQP3M1R0YFN	1.0		7.9 (8.70)		10.7 (8.8)	20.0			
ETQP4M2R2YFN	2.2		10.4 (11.44)		10.2 (8.0)	14.4			
ETQP4M3R3YFN	3.3		16.1 (17.71)		8.2 (6.4)	13.3			
ETQP4M6R8YFN	6.8		39.3 (43.20)		5.2 (4.1)	10.0			
ETQP4M100YFN	10.0		54.2 (59.60)		4.5 (3.5)	8.3			
ETQP4M220YFN	22.0		126.0 (138.60)		2.9 (2.3)	6.0			
ETQP4M330YFN	33.0		172.0 (189.20)		2.5 (2.0)	4.1			
ETQP4M470YFN	47.0		210.0 (231.00)		2.2 (1.8)	3.8			

*1: Measured at 100 kHz

*2: The proved current value for making the overall temperature rise of 40K, when mounted on a multi-layer board with high-heat dissipation (heat dissipation constant 6.5x6.0x3.0 mm : approx. 44 K/W, 6.5x6.0x4.5 mm : approx. 37 K/W).

*3: The proved current value for making the overall temperature rise of 40K, when mounted on a 4-layer circuit board of FR4 t=1.6 mm and DC current is applied.

*4: Saturation rated current : DC current which causes L(0) drop -30 %.

*5: Vibration resistance conditions : Amplitude: 5 mm or less, sweep speed: 1 oct / min, frequency 5-2000 Hz, 3 directions/2 hours each, total 6 hours

*6: The solderability is guaranteed for 1 year only. The product out of expiration date shall not be used.

◆ Within a suitable application, the part's temperature depends on circuit design and certain heat dissipation conditions. This should be double checked in a worst case operation mode. In normal case, the max.standard operating temperature of +150°C should not be exceeded. Please contact for possible to use over 150 °C condition. Temperature up to 180 °C may possibly be used.

Performance characteristics (Reference①)

● Inductance vs DC Current

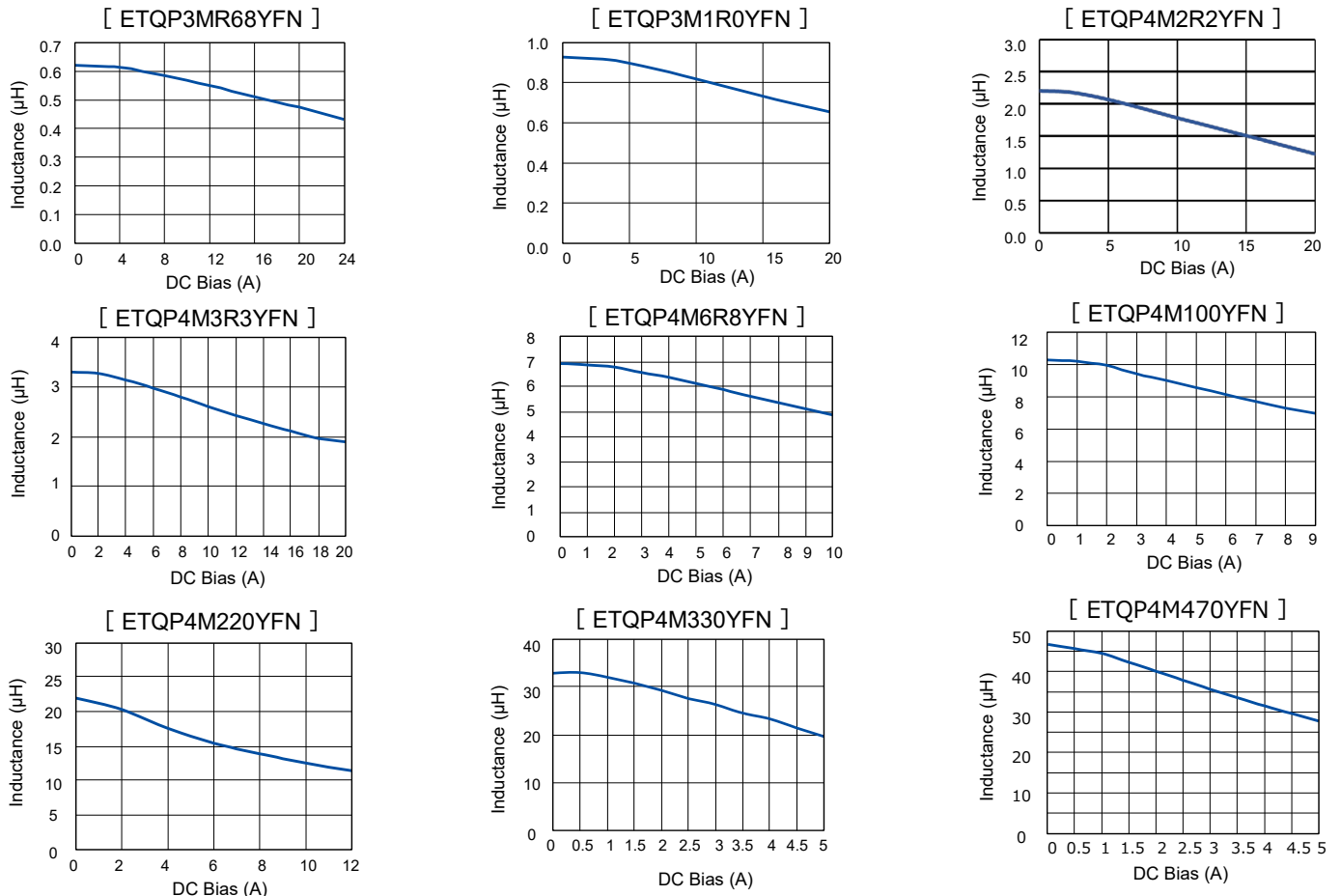

Performance characteristics (Reference②)

● Case Temperature vs DC Current

- PWB condition A : Four-layer PWB (1.6 mm FR4).^{*3}
- - - PWB condition B : Multilayer PWB with high heat dissipation performance.^{*2}

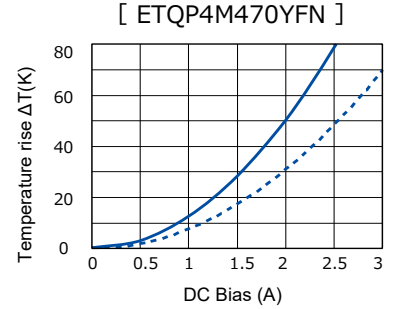
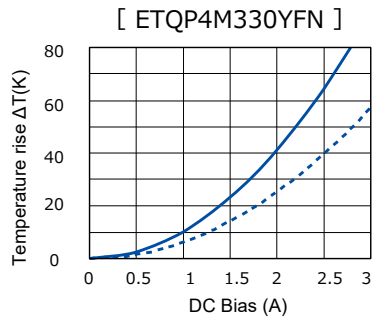
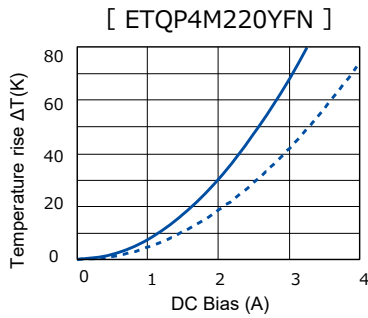
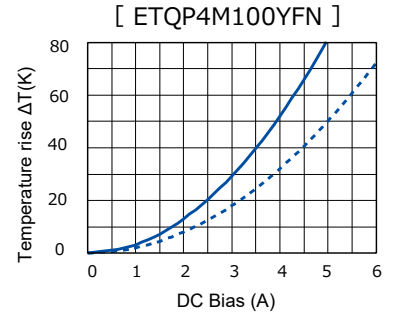
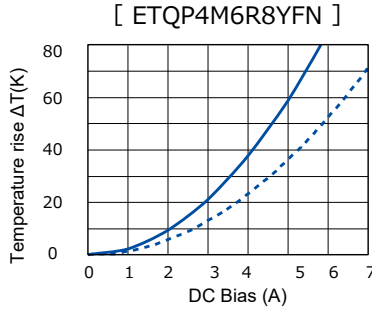
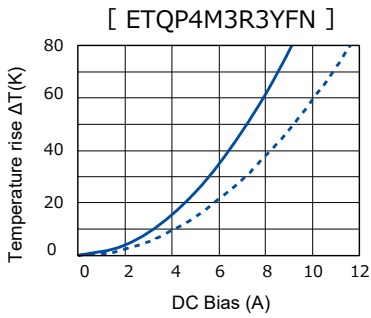
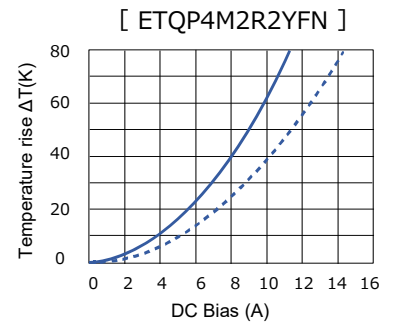
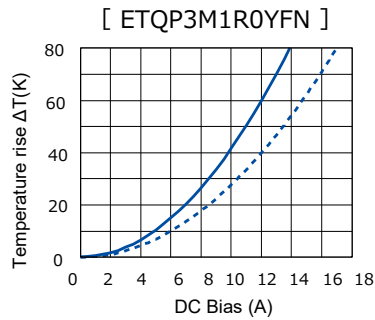
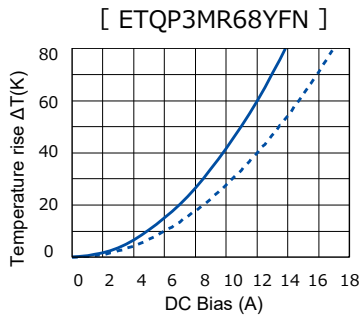

3. PCC-M0754M / PCC-M750M series (ETQP5M□□□YFM / YGM)

Standard parts

Part No.	Inductance *1		DCR (at 20 °C) (mΩ)		Rated current (A) Typ.		Vibration resistance (G)	MSL	Series [Size L×W×H] (mm)
	L0 (μH)	Tolerance (%)	Typ. (max.)	Tolerance (%)	$\Delta T=40\text{ K}^{*2}$ () ^{*3}	$\Delta L=$ -30 % ^{*4}			
ETQP5M3R3YFM	3.3	±20	11.9 (13.09)	±10	10.4 (8.3)	14.4	10.0	1	PCC-M0754M [7.0×7.5×5.4]
ETQP5M4R7YFM	4.7		20.4 (22.50)		8.0 (6.3)	13.1			
ETQP5M6R8YFM	6.8		26.7 (29.40)		6.9 (5.5)	12.1			
ETQP5M100YFM	10.0		37.6 (41.30)		5.7 (4.7)	10.6			
ETQP5M220YFM	22.0		92.0 (102.00)		3.7 (3.0)	5.8			
ETQP5M330YFM	33.0		120.0 (132.00)		3.3 (2.6)	4.8			
ETQP5M470YFM	48.0		156.0 (172.00)		2.9 (2.3)	4.1			
ETQP5M680YFM	68.0		251.0 (276.10)		2.3 (1.9)	3.9			
ETQP5M101YGM	95.0		348.0 (382.80)		1.9 (1.4)	3.5	3	PCC-M0750M [7.0×7.5×5.0]	

*1: Measured at 100 kHz

*2: The proved current value for making the overall temperature rise of 40K, when mounted on a multi-layer board with high-heat dissipation (heat dissipation constant 7.5x7.0x5.4 mm : approx. 31 K/W, 7.5x7.0x5.0 mm : approx. 29 K/W).

*3: The proved current value for making the overall temperature rise of 40K, when mounted on a 4-layer circuit board of FR4 t=1.6 mm and DC current is applied.

*4: Saturation rated current : DC current which causes L(0) drop -30 %.

*5: Vibration resistance conditions : Amplitude: 5 mm or less, sweep speed: 1 oct / min, frequency 5-2000 Hz, 3 directions/2 hours each, total 6 hours

*6: The solderability is guaranteed for 1 year only. The product out of expiration date shall not be used.

◆ Within a suitable application, the part's temperature depends on circuit design and certain heat dissipation conditions. This should be double checked in a worst case operation mode. In normal case, the max.standard operating temperature of +150°C should not be exceeded. Please contact for possible to use over 150 °C condition. Temperature up to 180 °C may possibly be used.

Performance characteristics (Reference ①)

● Inductance vs DC Current

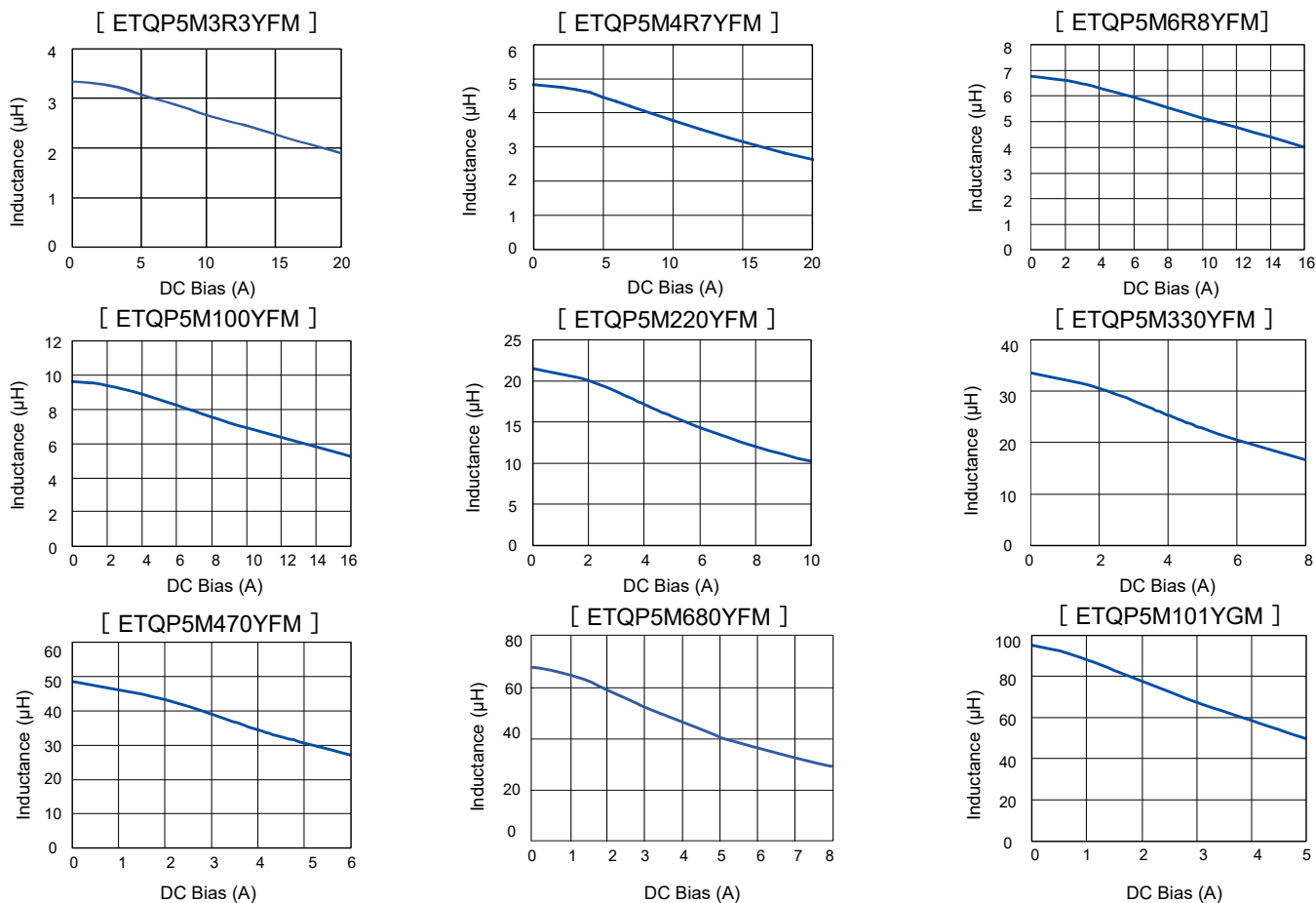

Performance characteristics (Reference②)

● Case Temperature vs DC Current

- PWB condition A : Four-layer PWB (1.6 mm FR4).^{*3}
- - - PWB condition B : Multilayer PWB with high heat dissipation performance.^{*2}

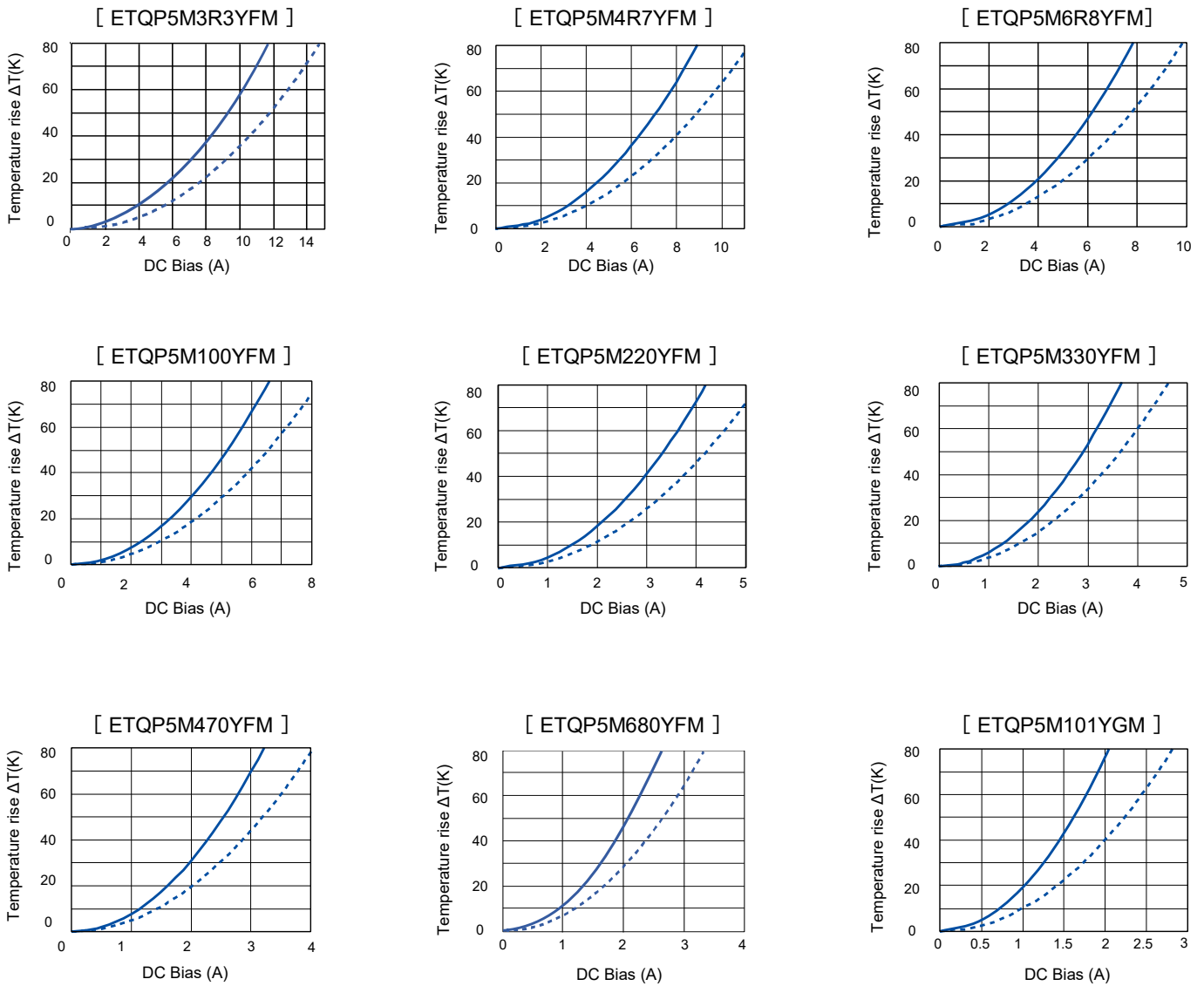

4. PCC-M0854M / PCC-M0850M series (ETQP5M□□□YFK / GAK / YGK)

Standard parts

Part No.	Inductance ^{*1}		DCR (at 20 °C) (mΩ)		Rated current (A) Typ.		Vibration resistance (G)	MSL	Series [Size L×W×H] (mm)
	L0 (μH)	Tolerance (%)	Typ. (max.)	Tolerance (%)	$\Delta T = 40 \text{ K}^2$ () ^{*3}	$\Delta L =$ -30 % ^{*4}	*5	*6	
ETQP5M2R5YFK	2.5	±20	7.6 (8.40)	±10	14.0 (11.9)	20.1	10.0	1	PCC-M0854M [8.0×8.5×5.4]
ETQP5M3R3YFK	3.3		9.5 (10.45)		12.5 (10.7)	17.9			
ETQP5M100YFK	10.0		33.4 (36.80)		6.7 (5.7)	11.3			
ETQP5M150YFK	15.0		48.2 (53.10)		5.5 (4.7)	7.7			
ETQP5M220YFK	22.0		63.0 (70.00)		4.8 (4.1)	6.9			
ETQP5M470YFK	48.0		125.0 (138.00)		3.4 (2.9)	5.4			
ETQP5M100GAK	10.0		31.5 (34.65)		6.9 (5.9)	11.1			
ETQP5M101YGK	100.0		302.0 (333.00)		2.1 (1.7)	3.0	5.0	3	PCC-M0850M [8.0×8.5×5.0]

*1: Measured at 100 kHz

*2: The proved current value for making the overall temperature rise of 40K, when mounted on a multi-layer board with high-heat dissipation (heat dissipation constant 8.5x8.0x5.4 mm : approx. 27 K/W, 8.5x8.0x5.0 mm : approx. 29 K/W).

*3: The proved current value for making the overall temperature rise of 40K, when mounted on a 4-layer circuit board of FR4 t=1.6 mm and DC current is applied.

*4: Saturation rated current : DC current which causes L(0) drop -30 %.

*5: Vibration resistance conditions : Amplitude: 5 mm or less, sweep speed: 1 oct / min, frequency 5-2000 Hz, 3 directions/2 hours each, total 6 hours

*6: The solderability is guaranteed for 1 year only. The product out of expiration date shall not be used.

◆ Within a suitable application, the part's temperature depends on circuit design and certain heat dissipation conditions. This should be double checked in a worst case operation mode. In normal case, the max.standard operating temperature of +150°C should not be exceeded. Please contact for possible to use over 150 °C condition. Temperature up to 180 °C may possibly be used.

Performance characteristics (Reference①)

● Inductance vs DC Current

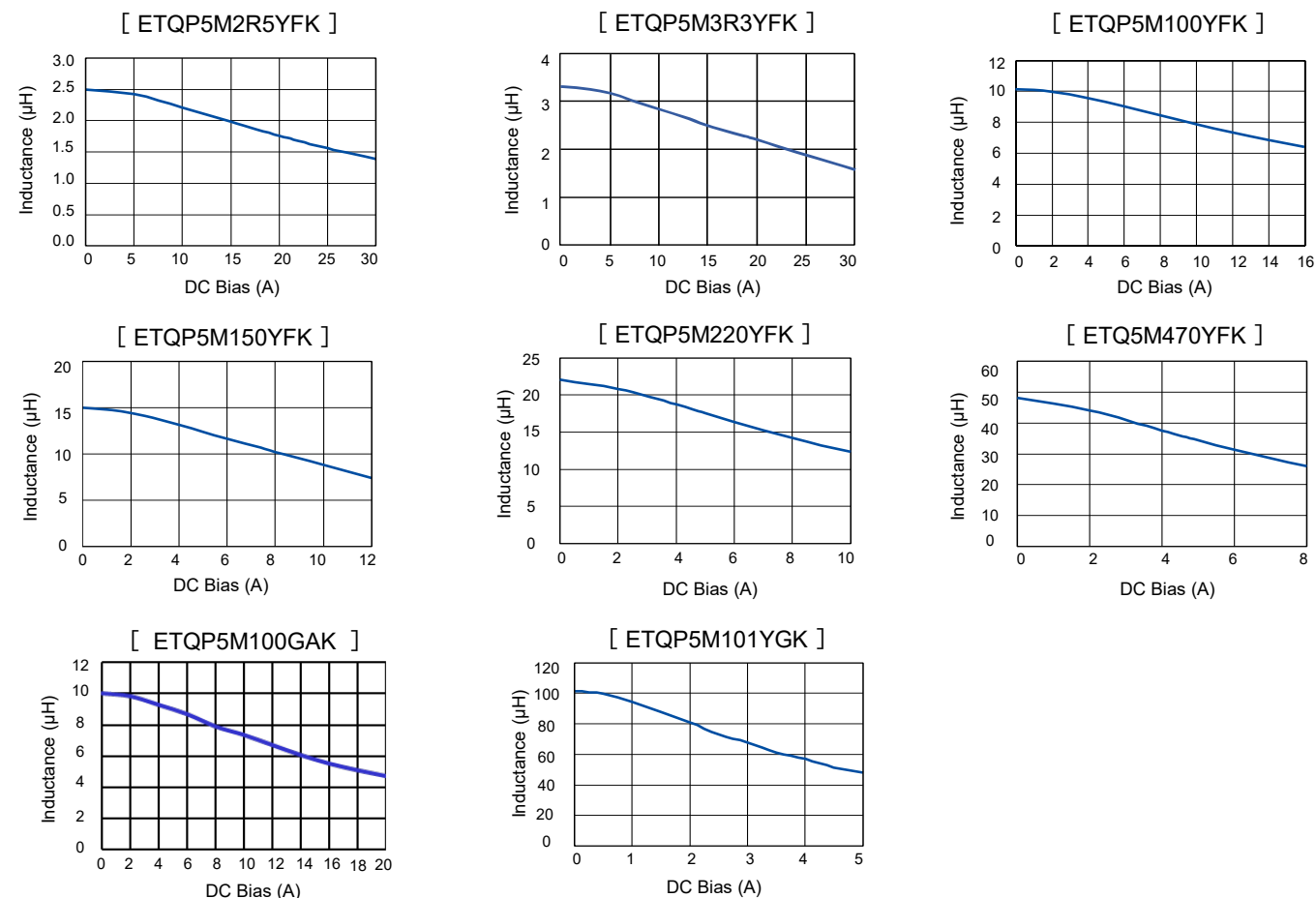

Performance characteristics (Reference②)

● Case Temperature vs DC Current

- PWB condition A : Four-layer PWB (1.6 mm FR4).^{*3}
- - - PWB condition B : Multilayer PWB with high heat dissipation performance.^{*2}

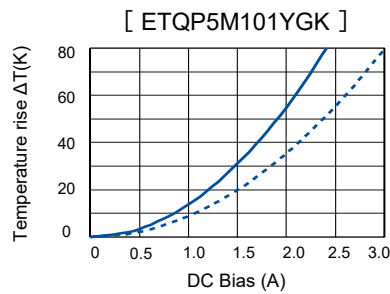
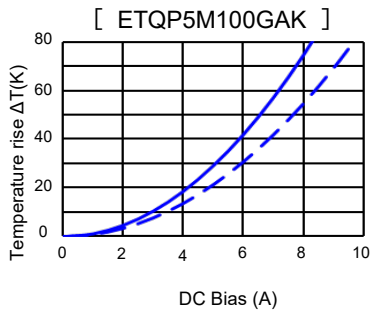
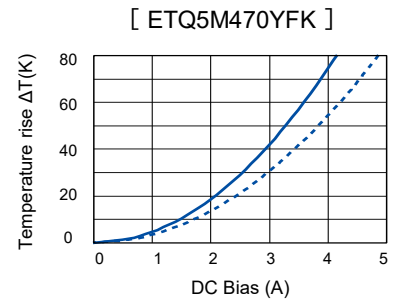
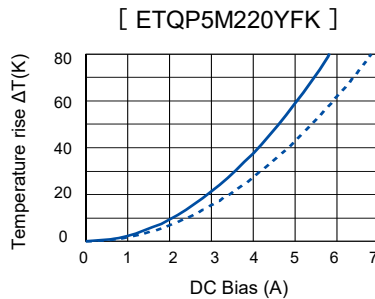
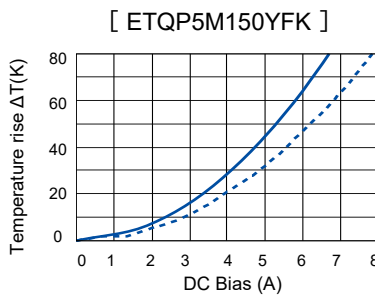
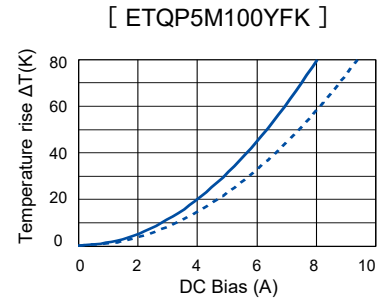
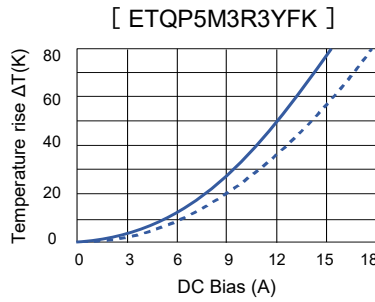
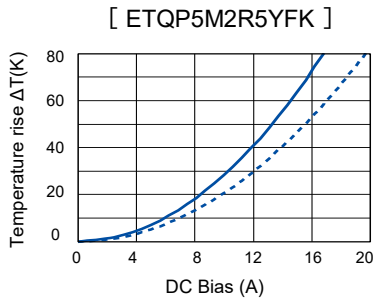

5. PCC-M1054M / PCC-M1050M series (ETQP5M□□□YFC / YGC)

Standard parts

Part No.	Inductance ^{*1}		DCR (at 20 °C) (mΩ)		Rated current (A) Typ.		Vibration resistance (G)	MSL	Series [Size L×W×H] (mm)
	L0 (μH)	Tolerance (%)	Typ. (max.)	Tolerance (%)	$\Delta T=40\text{K}^{\wedge 2}$ () ^{*3}	$\Delta L=$ -30 % ^{*4}	*5	*6	
ETQP5M1R5YFC	1.5	±20	3.8 (4.20)	±10	21.4 (17.9)	35.1	10.0	1	PCC-M1054M [10.0×10.7×5.4]
ETQP5M2R5YFC	2.5		5.3 (5.90)		18.1 (15.1)	27.2			
ETQP5M3R3YFC	3.3		7.1 (7.81)		15.7 (13.1)	22.7			
ETQP5M4R7YFC	4.7		10.2 (11.30)		13.1 (10.9)	20.0			
ETQP5M100YFC	10.0		23.8 (26.20)		8.5 (7.1)	12.0			
ETQP5M150YFC	15.0		35.6 (39.16)		7.0 (5.8)	11.2			
ETQP5M220YFC	22.0		45.0 (50.00)		6.2 (5.2)	9.2			
ETQP5M330YFC	33.0		68.5 (75.40)		5.0 (4.2)	7.6			
ETQP5M470YFC	47.0		99.0 (108.90)		4.2 (3.5)	6.8			
ETQP5M680YFC	66.0		136.0 (149.60)		3.6 (3.0)	5.2			
ETQP5M3R3YGC	3.3		7.1 (7.81)		14.7 (11.8)	23.4			
ETQP5M820YGC	82.0		194.0 (213.4)		2.8 (2.2)	4.3			
ETQP5M101YGC	97.0		208.0 (229.00)		2.7 (2.2)	3.0			
							3	PCC-M1050M [10.0×10.7×5.0]	

*1: Measured at 100 kHz

*2: The proved current value for making the overall temperature rise of 40K, when mounted on a multi-layer board with high-heat dissipation (heat dissipation constant 10.7x10.0x5.4 mm : approx. 23 K/W, 10.7x10.0x5.0 mm : approx. 26 K/W).

*3: The proved current value for making the overall temperature rise of 40K, when mounted on a 4-layer circuit board of FR4 t=1.6 mm and DC current is applied.

*4: Saturation rated current : DC current which causes L(0) drop -30 %.

*5: Vibration resistance conditions : Amplitude: 5 mm or less, sweep speed: 1 oct / min, frequency 5-2000 Hz, 3 directions/2 hours each, total 6 hours

*6: The solderability is guaranteed for 1 year only. The product out of expiration date shall not be used.

◆ Within a suitable application, the part's temperature depends on circuit design and certain heat dissipation conditions. This should be double checked in a worst case operation mode. In normal case, the max.standard operating temperature of +150°C should not be exceeded. Please contact for possible to use over 150 °C condition. Temperature up to 180 °C may possibly be used.

Performance characteristics (Reference①)

● Inductance vs DC Current

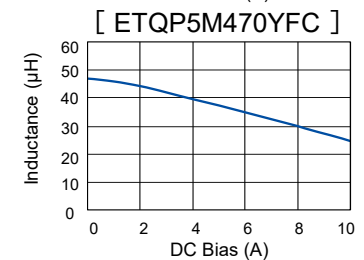
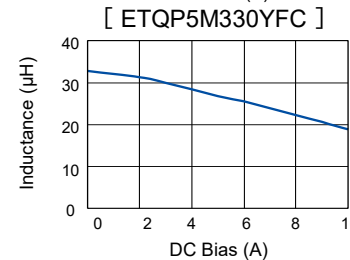
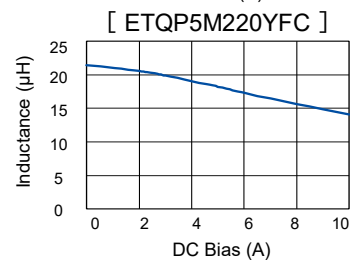
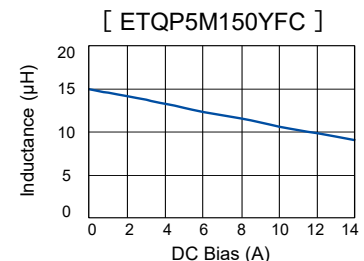
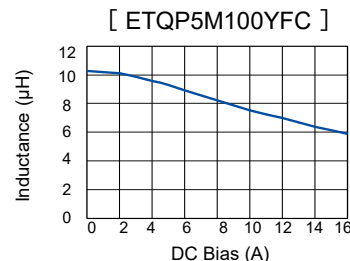
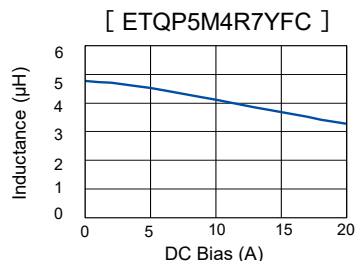
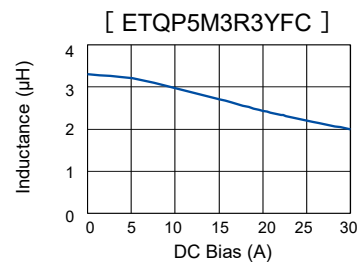
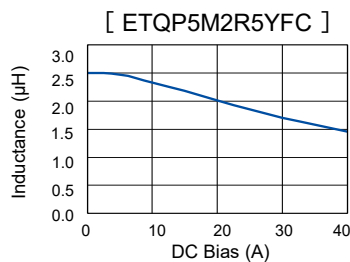
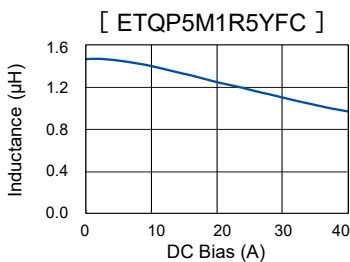

Performance characteristics (Reference①)

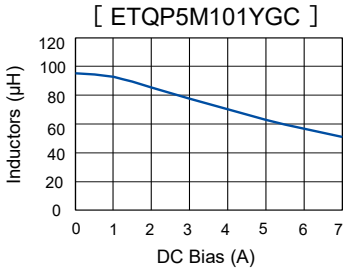
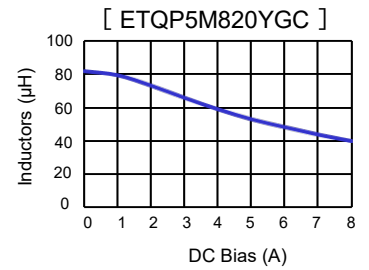
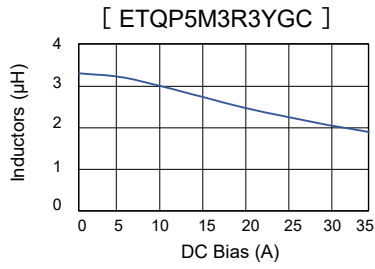
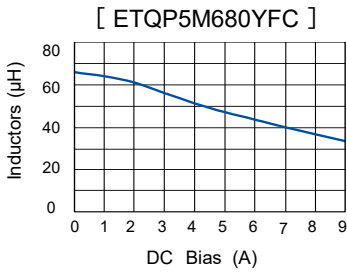

Performance characteristics (Reference②)

● Case Temperature vs DC Current

- PWB condition A : Four-layer PWB (1.6 mm FR4).^{*3}
- - - PWB condition B : Multilayer PWB with high heat dissipation performance.^{*2}

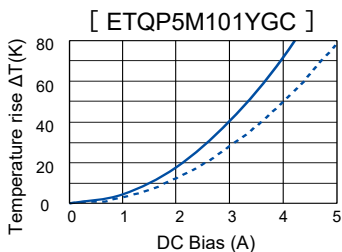
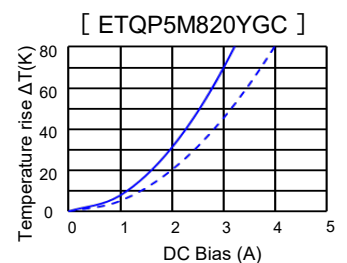
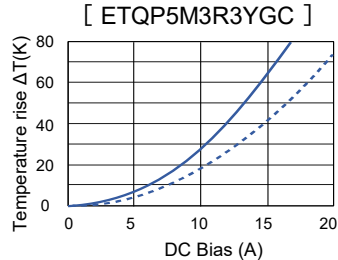
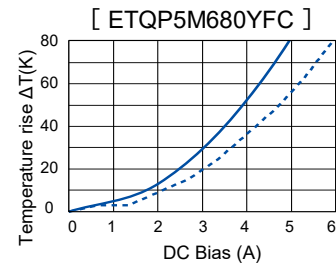
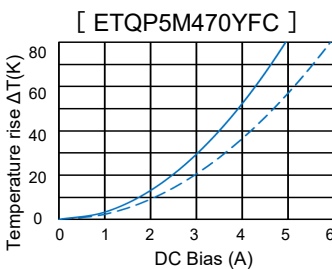
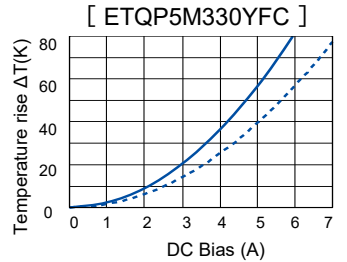
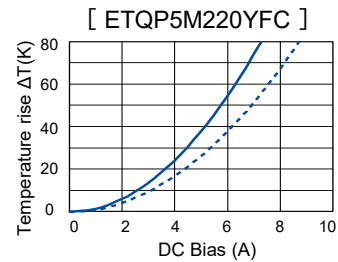
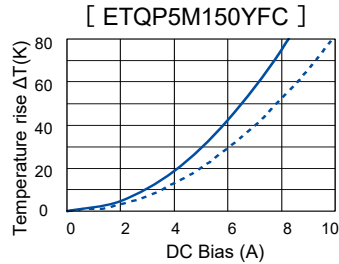
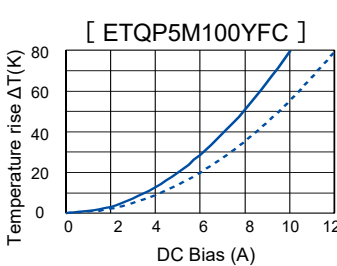
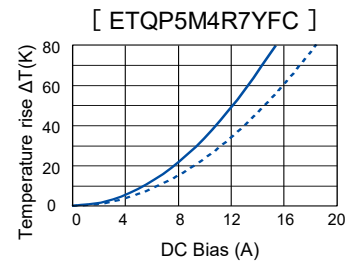
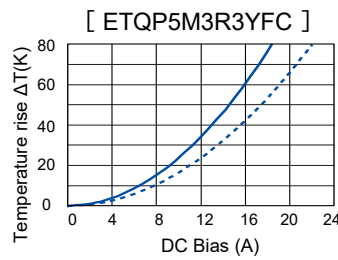
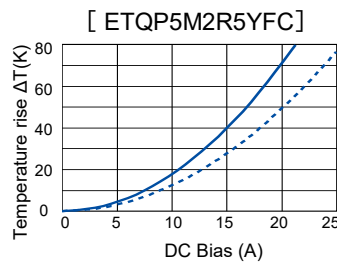
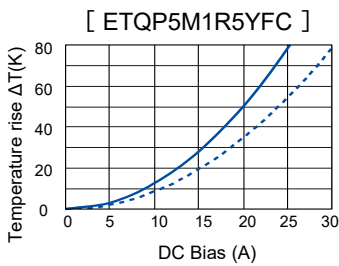

6. PCC-M1040ML / PCC-M1050ML / PCC-M1060ML series
(ETQP4M□□□KLC / ETQP5M□□□YLC / ETQP6M□□□YLC / KLC)

Standard parts

Part No.	Inductance *1		DCR (at 20 °C) (mΩ)		Rated current (A) Typ.		Vibration resistance (G)	MSL	Series [Size L×W×H] (mm)
	L0 (μH)	Tolerance (%)	Typ. (max.)	Tolerance (%)	ΔT= 40 K*2 () *3	ΔL= -30 %*4			
ETQP4MR47KLC	0.47	±20	1.53 (1.68)	±10	31.1 (24.9)	47.3	10.0	1	PCC-M1040ML [10.0×10.9×4.0]
ETQP5MR33YLC	0.33		1.1 (1.21)		39.7 (33.2)	56.7			PCC-M1050ML [10.0×10.9×5.0]
ETQP5MR68YLC	0.68		1.75 (1.93)		31.5 (26.3)	40.0			
ETQP5M1R0YLC	1.0		2.3 (2.53)		27.5 (23.0)	37.8			
ETQP5M2R0YLC	2.0		4.6 (5.06)		19.4 (16.2)	31.3			
ETQP6M1R5YLC	1.5		3.2 (3.52)		23.3 (19.5)	32.0			PCC-M1060ML [10.0×10.9×6.0]
ETQP6M2R5YLC	2.5		4.55 (5.00)		19.6 (16.3)	25.8			
ETQP6M3R3YLC	3.3		6.0 (6.60)		17.0 (14.2)	26.3			
ETQP6M4R7YLC	4.7		8.7 (9.57)		14.1 (11.8)	22.5			
ETQP6M150KLC	14.0		28.0 (30.80)		7.9(6.5)	11.2			

*1: Measured at 100 kHz

*2: The proved current value for making the overall temperature rise of 40K, when mounted on a multi-layer board with high-heat dissipation (heat dissipation constant 10.9x10.0x4.0 mm : approx. 27 K/W, 10.9x10.0x5.0 mm : approx. 23 K/W, 10.9x10.0x6.0 mm : approx. 23 K/W).

*3: The proved current value for making the overall temperature rise of 40K, when mounted on a 4-layer circuit board of FR4 t=1.6 mm and DC current is applied.

*4: Saturation rated current : DC current which causes L(0) drop -30 %.

*5: Vibration resistance conditions : Amplitude: 5 mm or less, sweep speed: 1 oct / min, frequency 5-2000 Hz, 3 directions/2 hours each, total 6 hours

*6: The solderability is guaranteed for 1 year only. The product out of expiration date shall not be used.

◆ Within a suitable application, the part's temperature depends on circuit design and certain heat dissipation conditions. This should be double checked in a worst case operation mode. In normal case, the max.standard operating temperature of +150°C should not be exceeded. Please contact for possible to use over 150 °C condition. Temperature up to 180 °C may possibly be used.

Performance characteristics (Reference①)

● Inductance vs DC Current

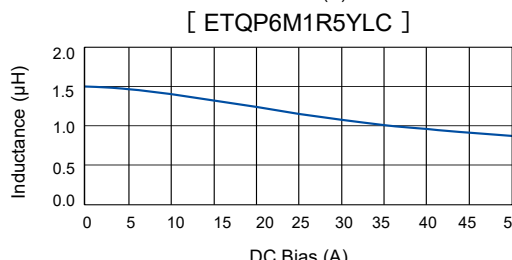
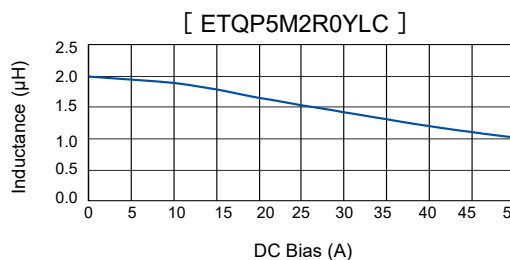
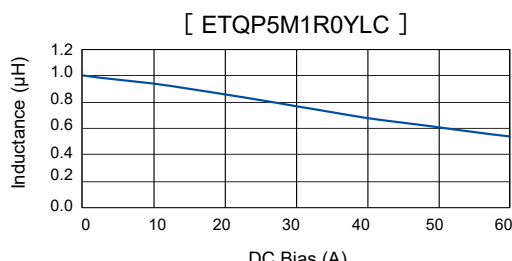
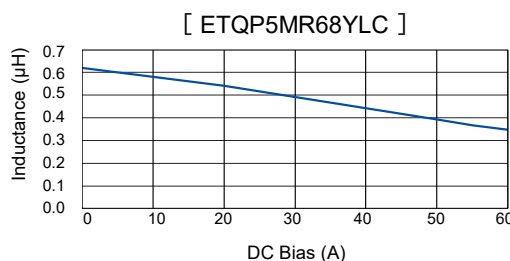
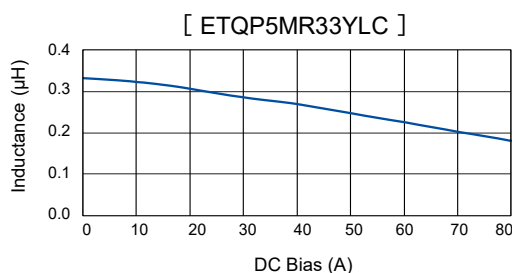
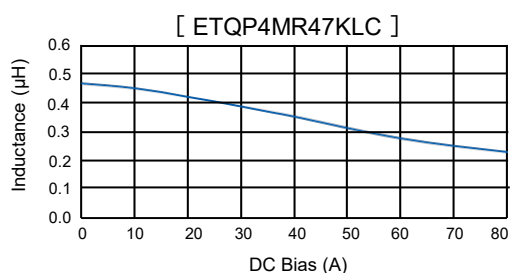

Performance characteristics (Reference①)

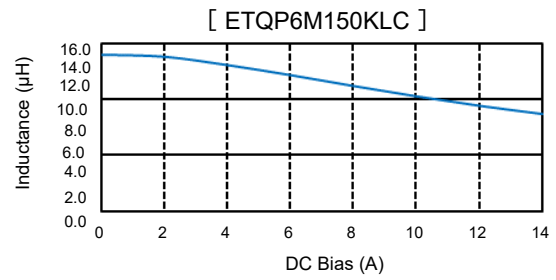
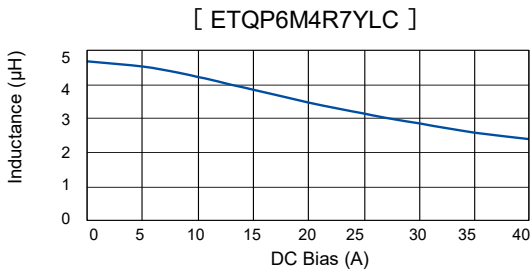
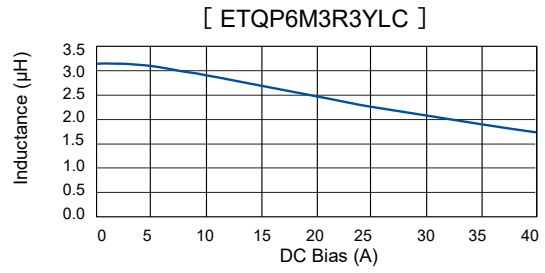
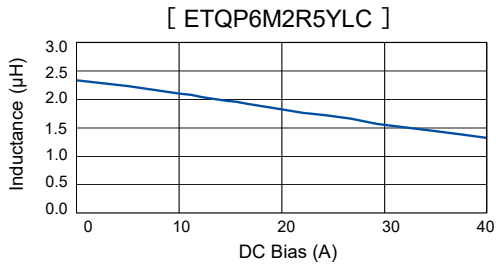

Performance characteristics (Reference②)

● Case Temperature vs DC Current

- PWB condition A : Four-layer PWB (1.6 mm FR4).^{*3}
- - - PWB condition B : Multilayer PWB with high heat dissipation performance.^{*2}

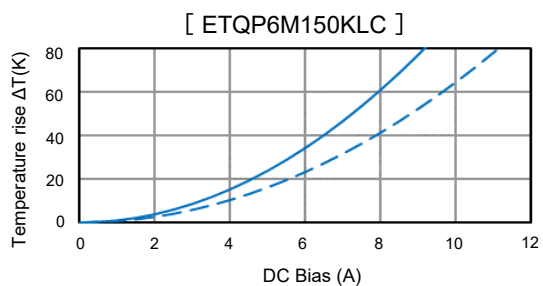
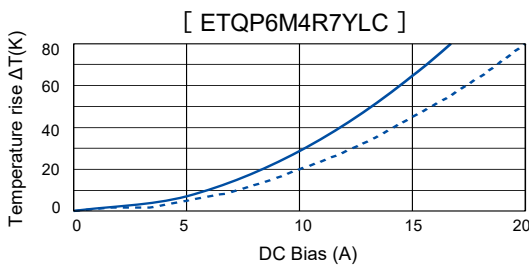
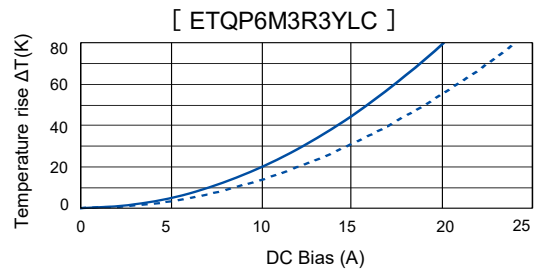
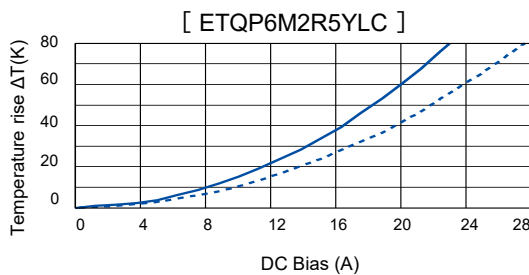
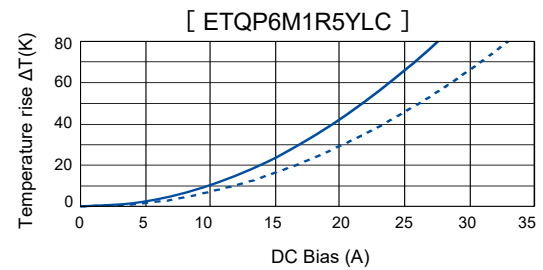
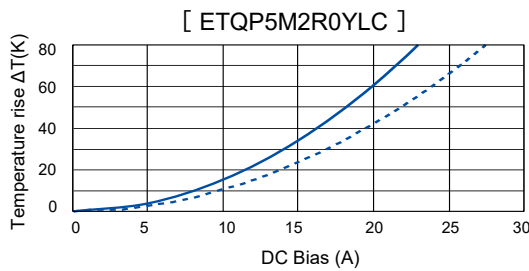
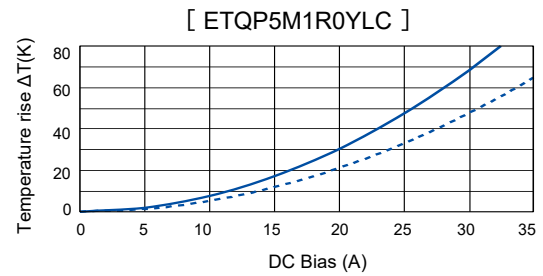
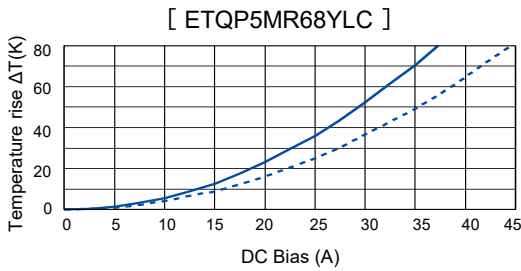
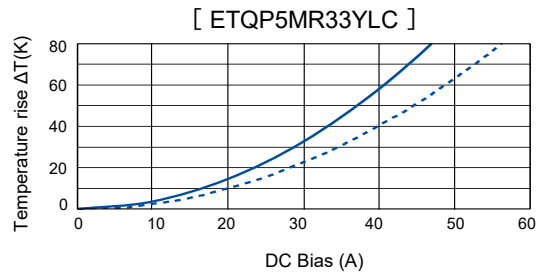
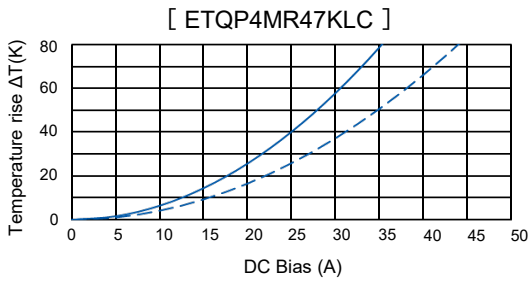

Dimensions in mm (not to scale)

Dimensional tolerance unless noted : ± 0.5

Series PCC-M0530M
Series PCC-M0540M
 (ETQP3M□□□YFP/ETQP4M□□□YFP)

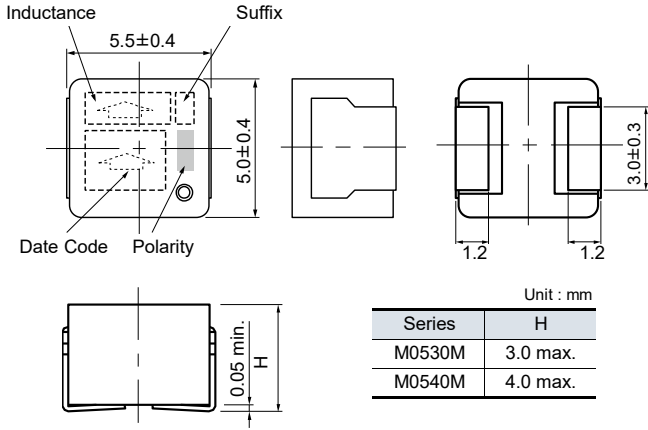

Series PCC-M0630M
Series PCC-M0645M
 (ETQP3M□□□YFN/ETQP4M□□□YFN)

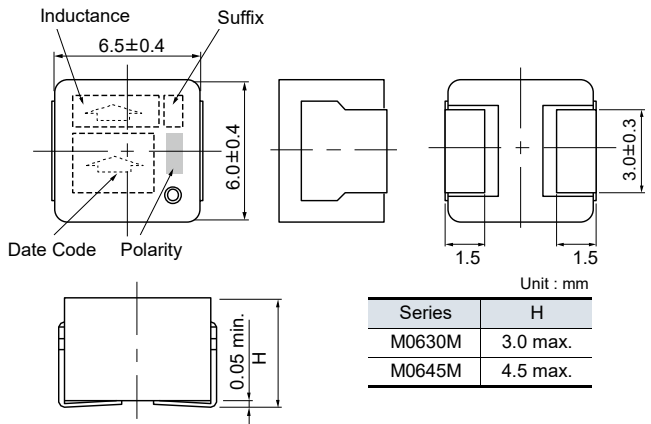

Series PCC-M0754M
Series PCC-M0750M
 (ETQP5M□□□YFM/YGM)

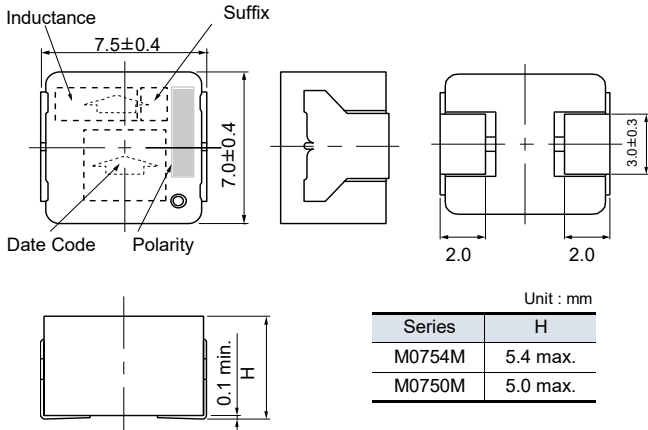

Series PCC-M0854M
Series PCC-M0850M
 (ETQP5M□□□YFK/GAK/YGK)

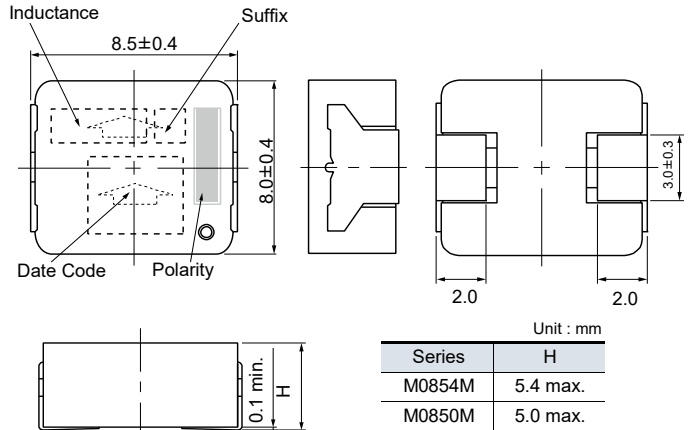

Series PCC-M1054M
Series PCC-M1050M
 (ETQP5M□□□YFC/YGC)

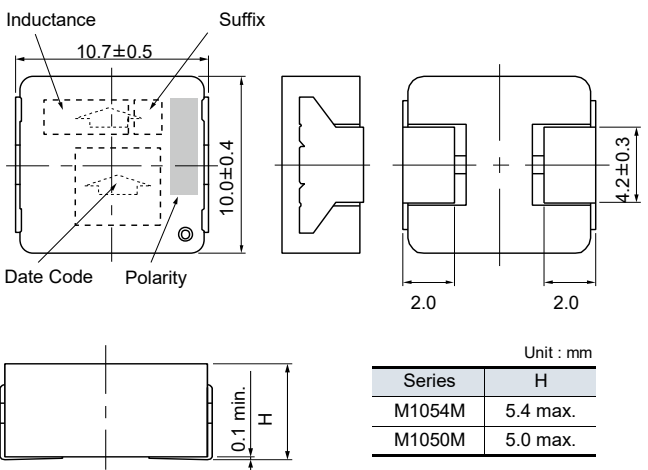

Series PCC-M1040ML
 (ETQP4M□□□KLC)

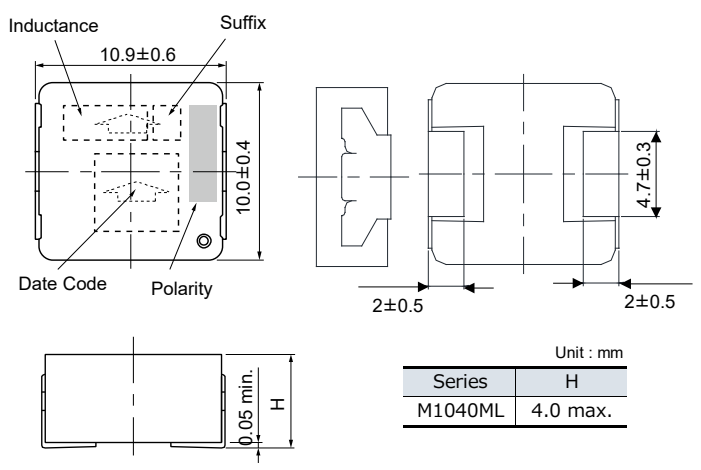

Power Choke Coil (Automotive Grade)

Dimensions in mm (not to scale)

Dimensional tolerance unless noted : ± 0.5

Series PCC-M1050ML
Series PCC-M1060ML
 (ETQP5M□□□YLC/ETQP6M□□□YLC/KLC)

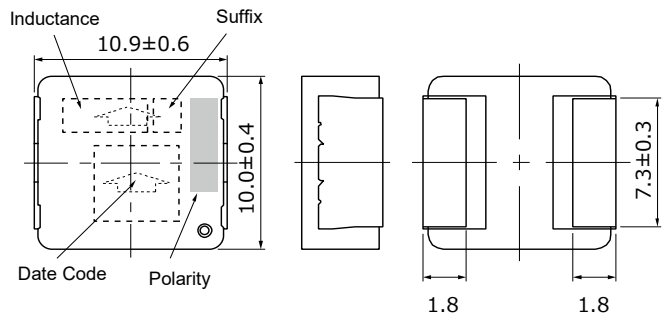

Series	H
M1050ML	5.0 max.
M1060ML	6.0 max.

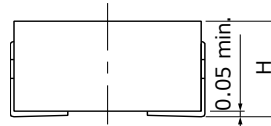

Recommended land pattern in mm (not to scale)

Dimensional tolerance unless noted : ± 0.5

Series PCC-M0530M
Series PCC-M0540M
 (ETQP3M□□□YFP/ETQP4M□□□YFP)

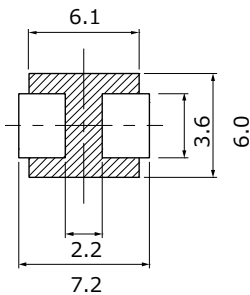

Series PCC-M0630M
Series PCC-M0645M
 (ETQP3M□□□YFN/ETQP4M□□□YFN)

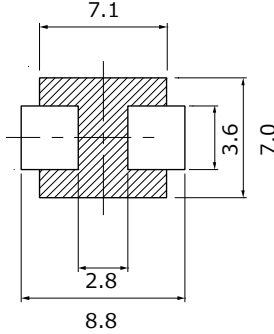

Series PCC-M0754M
Series PCC-M0750M
 (ETQP5M□□□YFM/YGM)

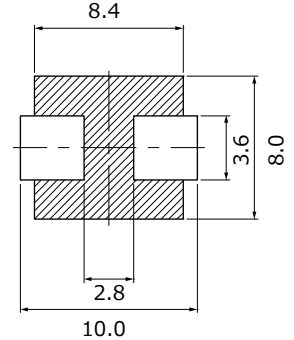

Series PCC-M0854M
Series PCC-M0850M
 (ETQP5M□□□YFK/GAK/YGK)

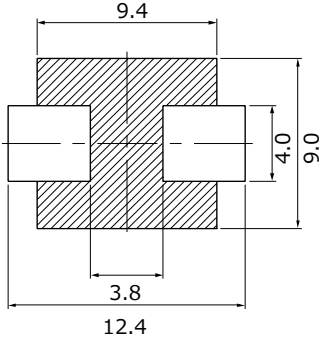

Series PCC-M1054M
Series PCC-M1050M
 (ETQP5M□□□YFC/YGC)

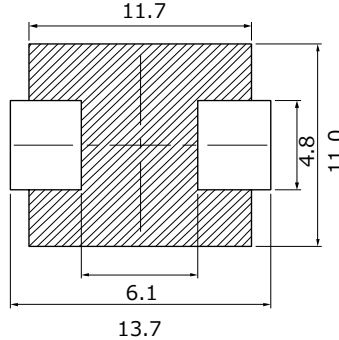

Series PCC-M1040ML
 (ETQP4M□□□KLC)

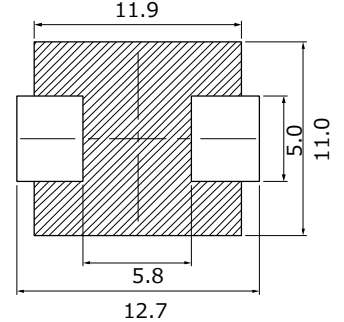

Series PCC-M1050ML
Series PCC-M1060ML
 (ETQP5M□□□YLC/ETQP6M□□□YLC/KLC)

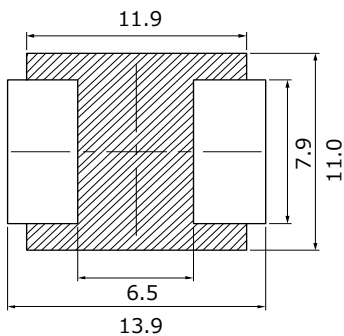

※Don't wire on the pattern on shaded portion the PWB.

Unit : mm

■ As for soldering conditions and safety precautions (Power choke coils (Automotive grade)), please see data files

Packaging methods (Taping)

● Embossed carrier tape

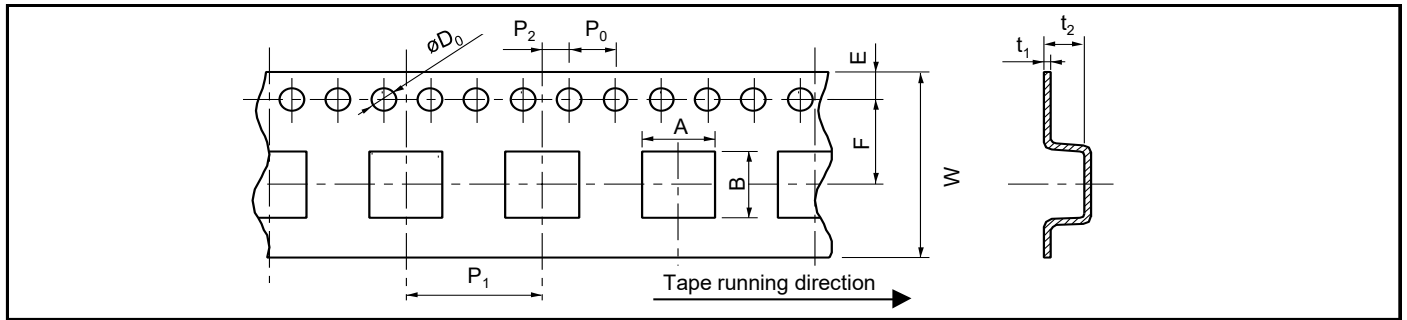

Series	A	B	W	E	F	P ₁	P ₂	P ₀	øD ₀	t ₁	t ₂
PCC-M0530M	5.6	6.1	16.0	1.75	7.5	12.0	2.0	4.0	1.5	0.4	3.3
PCC-M0540M											4.3
PCC-M0630M	7.1	6.6									3.3
PCC-M0645M											5.0
PCC-M0754M/M0750M	8.1	7.6									6.0
PCC-M0854M/M0850M	9.1	8.6									
PCC-M1054M/M1050M	10.65	11.75	24.0	11.5	16.0	0.5	6.35				
PCC-M1040ML/M1050ML/M1060ML											

● Taping reel

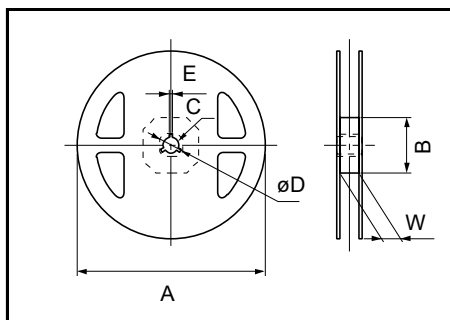

Series	A	B	C	øD	E	W
PCC-M0530M/M0540M	330	100	13	21	2	17.5
PCC-M0630M/M0645M						
PCC-M0754M/M0750M						
PCC-M0854M/M0850M						
PCC-M1054M/M1050M						
PCC-M1040ML/M1050ML/M1060ML						25.5

Parts mounting (Taping)

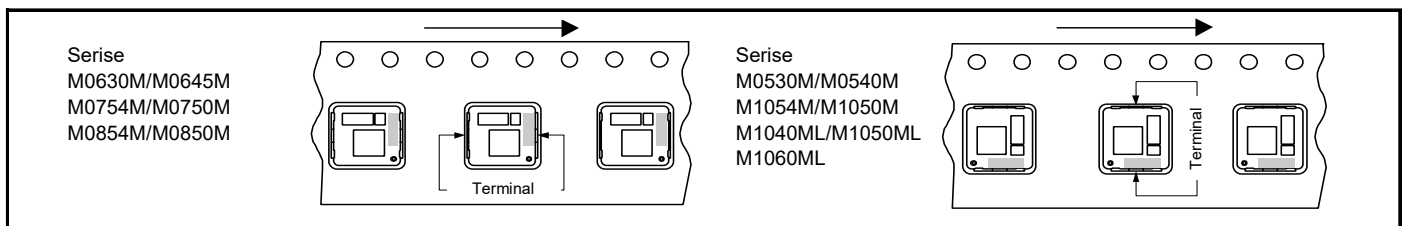

Standard packing quantity / Reel

Series	Part No.	Minimum quantity / Packing unit	Quantity per reel
PCC-M0530M	ETQP3M□□□YFP	2,000 pcs / box (2 reel)	1,000 pcs
PCC-M0540M	ETQP4M□□□YFP		
PCC-M0630M	ETQP3M□□□YFN		
PCC-M0645M	ETQP4M□□□YFN	1,000 pcs / box (2 reel)	500 pcs
PCC-M0754M	ETQP5M□□□YFM		
PCC-M0750M	ETQP5M□□□YGM		
PCC-M0854M	ETQP5M□□□YFK/GAK		
PCC-M0850M	ETQP5M□□□YGK		
PCC-M1054M	ETQP5M□□□YFC		
PCC-M1050M	ETQP5M□□□YGC		
PCC-M1040ML	ETQP4M□□□KLC		
PCC-M1050ML	ETQP5M□□□YLC		
PCC-M1060ML	ETQP6M□□□YLC/KLC		

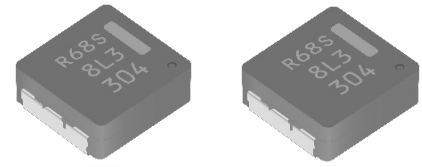

Power Inductors

Power Choke Coil (Automotive Grade)

PCC-M0854MS series

PCC-M1050MS series

High heat resistance and high reliability using metal composite core (MC)

Industrial property : Patents 18 (Registered 10 / Pending 8)

Features

- The vibration-resistant structure achieves a vibration acceleration-resistance of 50 G or higher in 150 °C environments
- Reduce core loss in high frequency band (More than 2 MHz)
- High heat resistance : Operation up to 150 °C including self-heating. (180 °C short time*)
* Please contact for possible to use over 150 °C condition. Temperature up to 180 °C may possibly be used.
- SMD type
- High-reliability : High vibration resistance as result of newly developed integral construction; under severe reliability conditions of automotive and other strenuous applications
- High bias current : Excellent inductance stability using ferrous alloy magnetic material
- Temp. stability : Excellent inductance stability over broad temp. range
- Low audible (buzz) noise : A gapless structure achieved with metal composite core
- High efficiency : Low DC resistance of winding and low eddy-current loss of the core
- Shielded construction
- AEC-Q200 compliant
- RoHS compliant

Recommended applications

- ECU placed in the engine itself, mechanical-electrical-integrated ECU
- Noise filter for various drive circuitry requiring high temp. operation and peak current handling capability
- Boost-Converter, Buck-Converter DC/DC

Standard packing quantity (Minimum quantity/Packing unit)

- 1,000 pcs/box (2 reel)

Temperature rating

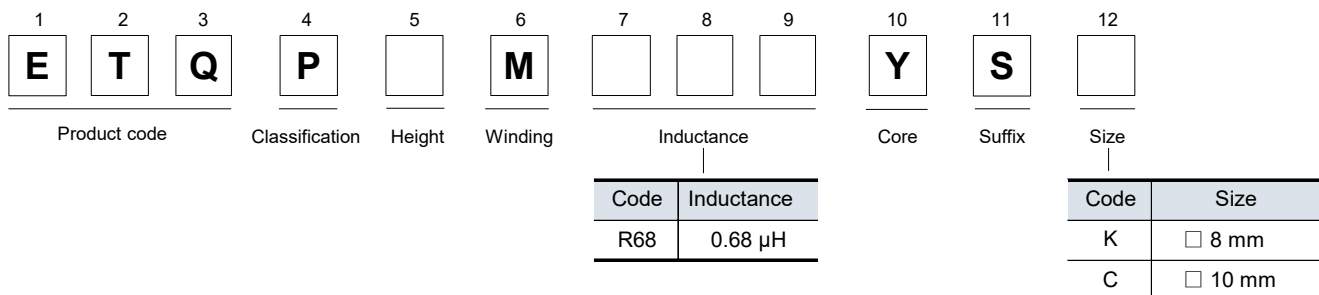

Temperature rating

Operating temperature range		Tc : -40 °C to +150 °C (Including self-temperature rise)
Storage condition	After PWB mounting	
	Before PWB mounting	Ta : -5 °C to +35 °C 85%RH max.

Power Choke Coil (Automotive Grade)

Standard parts

Part No.	Inductance *1		DCR (at 20 °C) (mΩ)		Rated current (A) Typ.		Vibration resistance (G)	MSL	Series [Size L×W×H] (mm)
	L0 (μH)	Tolerance (%)	Typ. (max.)	Tolerance (%)	ΔT= 40 K*2 ()*3	ΔL= -30 %*4			
ETQP5M2R5YSK	2.45	±20	7.4 (8.14)	±10	14.1 (12.0)	21.7	50.0	1	PCC-M0854MS [8.0×8.5×5.4]
ETQP5MR68YSC	0.68		1.66 (1.83)		32.3 (27.0)	40.0			PCC-M1050MS [10.0×10.9×5.0]
ETQP5M2R0YSC	1.90		4.45 (4.90)		19.8 (16.5)	29.8			PCC-M1056MS [10.0×10.9×5.6]
NEW ETQP5M220YSC	20.00		45.50 (50.05)		6.2 (5.2)	7.9			PCC-M1054MS [10.0×10.9×5.4]
NEW ETQP5M470YSC	44.00		102.00 (112.20)		4.1 (3.4)	5.7			PCC-M1060MS [10.0×10.9×6.0]
ETQP6M2R5YSC	2.50		4.48 (4.93)		19.7 (16.4)	23.7			

*1: Measured at 100 kHz

*2: The proved current value for making the overall temperature rise of 40K, when mounted on a multi-layer board with high-heat dissipation (heat dissipation constant 8.5 x 8.0 x 5.4 mm : approx. 27 K/W, 10.9 x 10.0 mm : approx. 23 K/W).

*3: The proved current value for making the overall temperature rise of 40K, when mounted on a 4-layer circuit board of FR4 t=1.6 mm and DC current is applied.

*4: Saturation rated current : DC current which causes L(0) drop -30 %.

*5: Vibration resistance conditions : Amplitude: 5 mm or less, sweep speed: 1 oct / min, frequency 5-2000 Hz, 3 directions/2 hours each, total 6 hours

*6: The solderability is guaranteed for 1 year only. The product out of expiration date shall not be used.

◆ Within a suitable application, the part's temperature depends on circuit design and certain heat dissipation conditions. This should be double checked in a worst case operation mode. In normal case, the max.standard operating temperature of +150°C should not be exceeded. Please contact for possible to use over 150 °C condition. Temperature up to 180 °C may possibly be used.

Performance characteristics (Reference①)

● Inductance vs DC Current

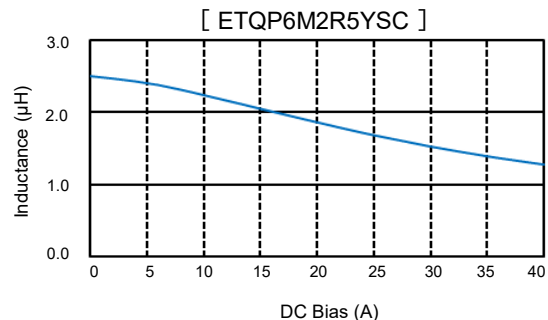
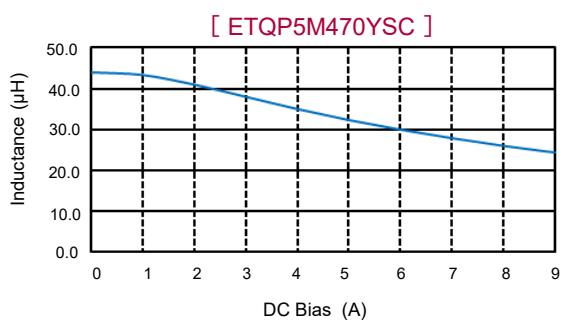
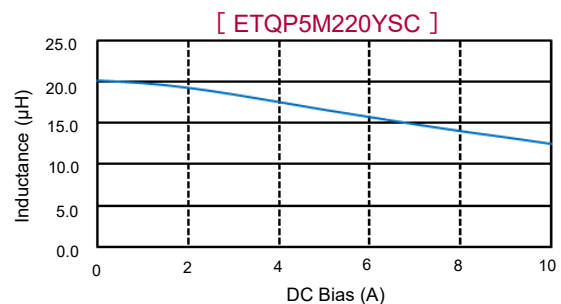
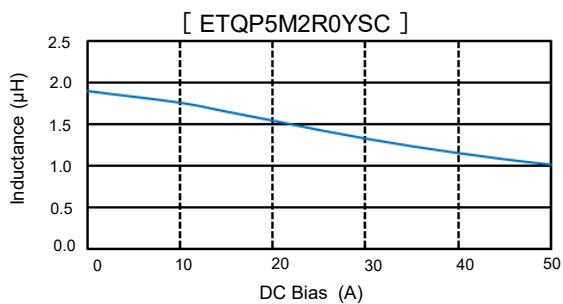
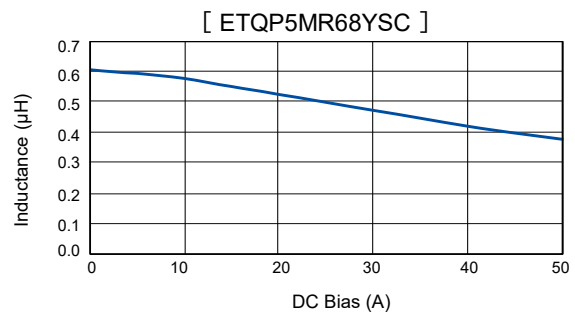
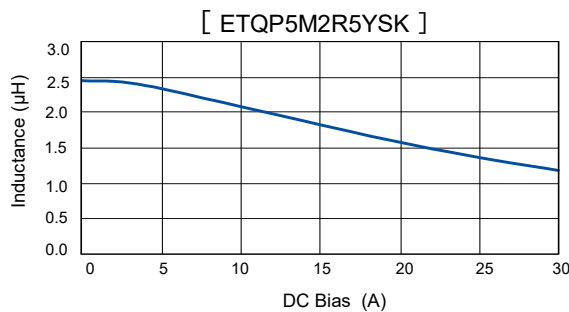

Performance characteristics (Reference②)

● Case Temperature vs DC Current

- PWB condition A : Four-layer PWB (1.6 mm FR4), See also *2
- - - PWB condition B : Multilayer PWB with high heat dissipation performance. See also *3

[ETQP5M2R5YSK]

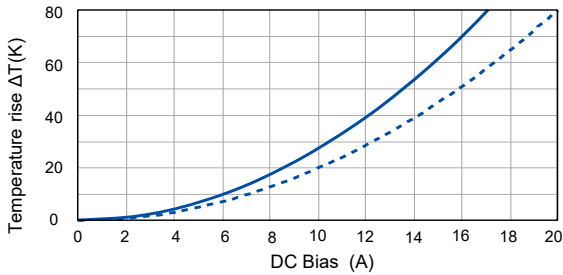

[ETQP5MR68YSC]

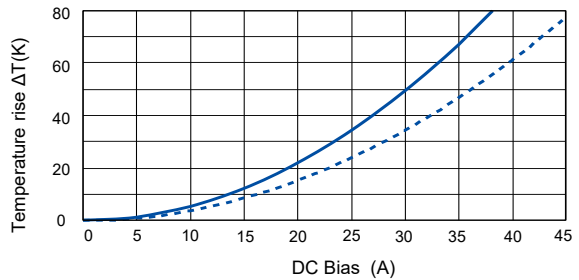

[ETQP5M2R0YSC]

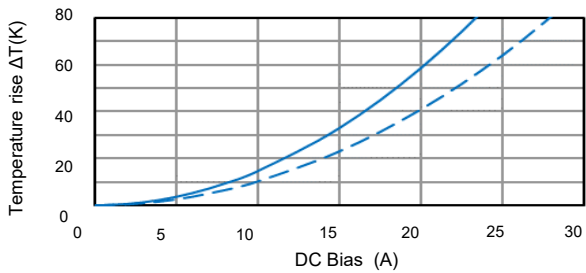

[ETQP5M220YSC]

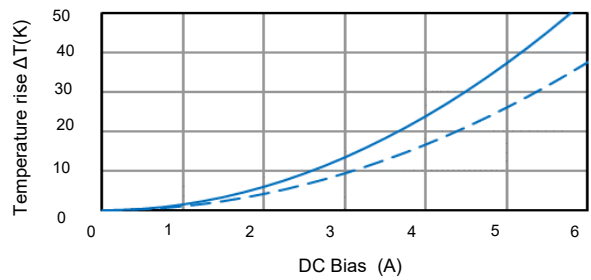

[ETQP5M470YSC]

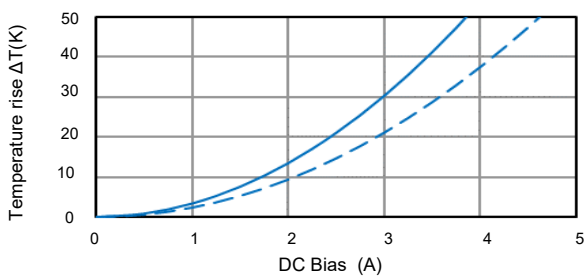

[ETQP6M2R5YSC]

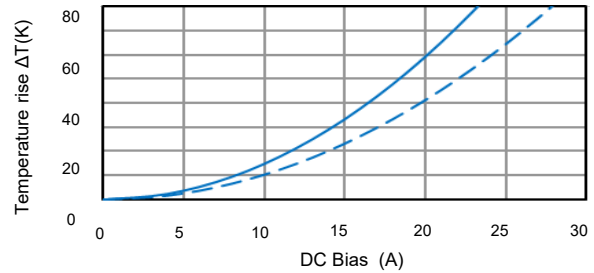

Dimensions in mm (not to scale)

Dimensional tolerance unless noted : ± 0.5

Series PCC-M0854MS

(ETQP5M□□□YSK)

Series PCC-M1050MS/54MS/56MS

Series PCC-M1060MS

(ETQP5M□□□YSC/ETQP6M□□□YSC)

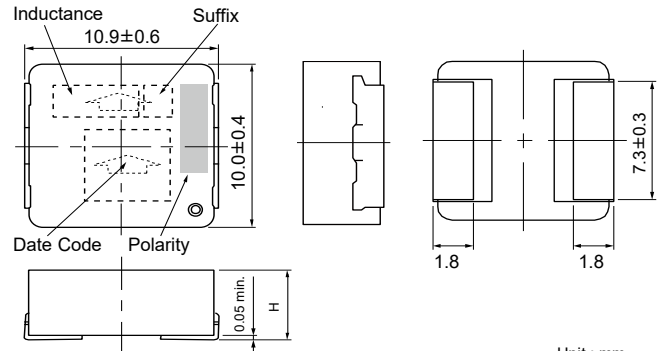
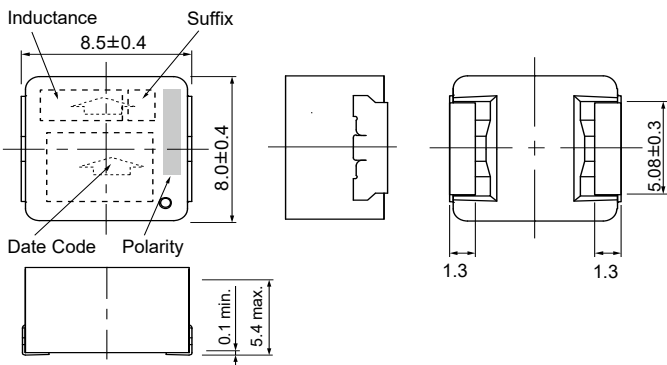

Unit : mm

Series	H
M105□MS	5.0/5.4/5.6 max.
M1060MS	6.0 max.

Recommended land pattern in mm (not to scale)

Dimensional tolerance unless noted : ± 0.5

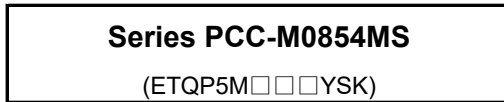

※Don't wire on the pattern on shaded portion the PWB.

Unit : mm

■ As for soldering conditions and safety precautions (Power choke coils (Automotive grade)), please see data files

Packaging methods (Taping)

● Embossed Carrier Tape Dimensions in mm (not to scale)

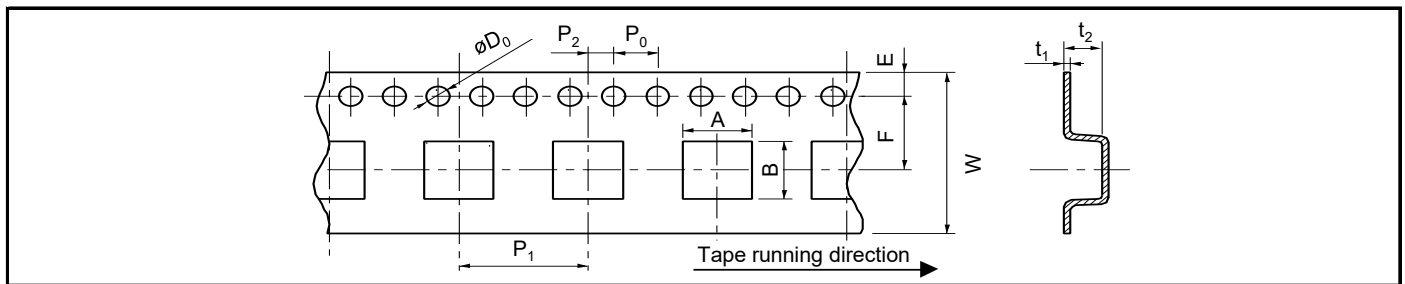

Unit : mm

Series	A	B	W	E	F	P ₁	P ₂	P ₀	øD ₀	t ₁	t ₂
PCC-M0854MS	9.1	8.6	16.0	1.75	7.5	12.0	2.0	4.0	1.5	0.4	6.0
PCC-M105□MS/M1060MS	10.65	11.75	24.0		11.5	16.0				0.5	6.35

● Taping Reel Dimensions in mm (not to scale)

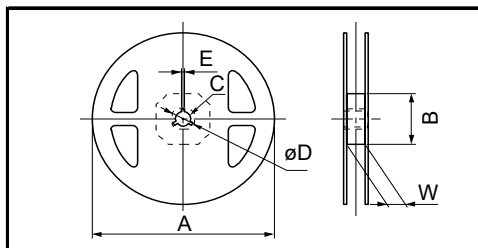

Standard Reel Dimensions

Unit : mm

Series	A	B	C	øD	E	W
PCC-M0854MS	330	100	13	21	2	17.5
PCC-M105□MS/M1060MS						25.5

Component placement (Taping)

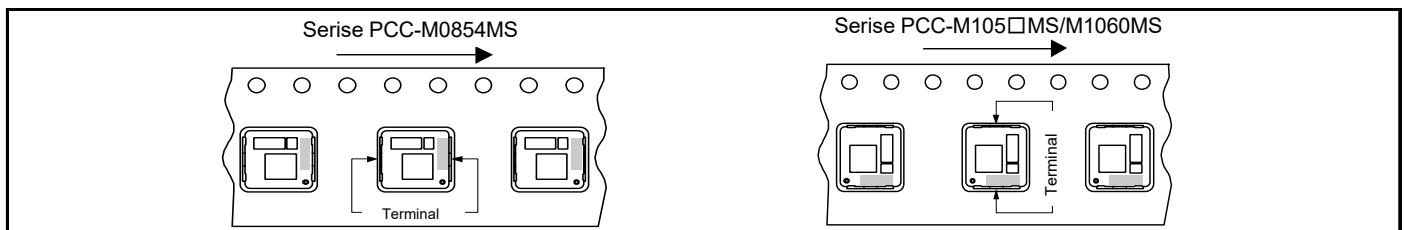

Standard packing quantity / Reel

Series	Part No.	Minimum quantity / Packing unit	Quantity per reel
PCC-M0854MS	ETQP5M YSK	1,000 pcs / box (2 reel)	500 pcs
PCC-M105□MS	ETQP5M YSC		
PCC-M1060MS	ETQP6M YSC		

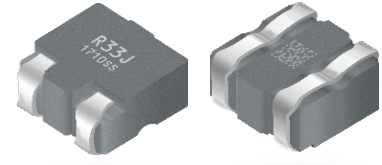

Power Inductors

Power Choke Coil (Automotive Grade)

PCC-M1280MF series

PCC-M15A0MF series

High heat resistance and high reliability using metal composite core (MC)

Industrial property : Patents 3

Features

- High heat resistance : Operation up to 160 °C including self-heating. (180 °C short time*)
* Please contact for possible to use over 160 °C condition. Temperature up to 180 °C may possibly be used.
- Large current power : 53 A (M1280MF R33 type), 87 A (M15A0MF R33 type)
- High vibration resistance : 30 G
- SMD type
- High-reliability : High vibration resistance as result of newly developed integral construction ; under severe reliability conditions of automotive and other strenuous applications
- High bias current : Excellent inductance stability using ferrous alloy magnetic material
- Temp. stability : Excellent inductance stability over broad temp. range
- Low audible (buzz) noise : A gapless structure achieved with metal composite core
- High efficiency : Low DC resistance of winding and low eddy-current loss of the core
- Shielded construction
- AEC-Q200 compliant
- RoHS compliant

Recommended applications

- Noise filter for various drive circuitry requiring high temp. operation and peak current handling capability
- Boost-Converter, Buck-Converter DC/DC

Standard packing quantity (Minimum quantity/Packing unit)

- 500 pcs/box (2 reels): PCC-M1280MF series (ETQP8M□□□JFA)
- 200 pcs/box (2 reels): PCC-M15A0MF series (ETQPAM□□□JFW)

Explanation of part numbers

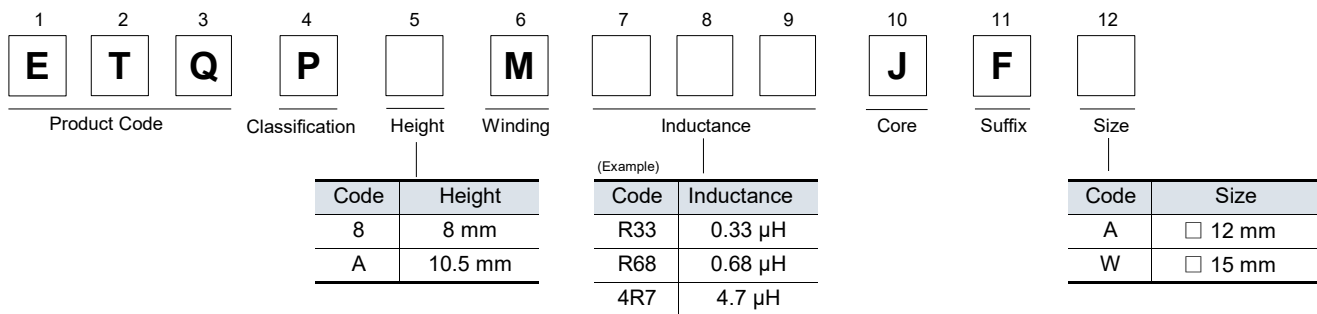

Temperature rating

Operating temperature range		Tc : -40 °C to +160 °C (Including self-temperature rise)
Storage condition	After PWB mounting	
	Before PWB mounting	Ta : -5 °C to +35 °C 85%RH max.

1. PCC-M1280MF series

Standard parts

Part No.	Inductance*1		DCR (at 20 °C) (mΩ)		Rated current (A) Typ.		Vibration resistance (G)	MSL	Series [Size L×W×H] (mm)
	L0 (μH)	Tolerance (%)	Typ. (max.)	Tolerance (%)	$\Delta T = 40 \text{ K}^{*2}$ () ^{*3}	$\Delta L =$ -30 % ^{*4}			
ETQP8MR33JFA	0.33	±20	0.7 (0.77)	±10	53.5 (44.4)	84.5	30.0	1	PCC-M1280MF [13.2×12.6×8.0]
ETQP8MR68JFA	0.68		1.1 (1.21)		42.6 (35.4)	56.9			
ETQP8M1R0JFA	1.0		1.36 (1.50)		38.3 (31.8)	44.4			
ETQP8M1R5JFA	1.5		1.8 (1.98)		33.3 (27.7)	29.9			
ETQP8M2R5JFA	2.5		2.6 (2.86)		27.7 (23.0)	32.1			
ETQP8M3R3JFA	3.3		3.6 (3.96)		23.6 (19.6)	27.6			
ETQP8M4R7JFA	4.7		4.9 (5.39)		20.2 (16.8)	24.7			

*1: Measured at 100 kHz

*2: The proved current value for making the overall temperature rise of 40K, when mounted on a multi-layer board with high-heat dissipation (heat dissipation constant : approx. 20 K/W).

*3: The proved current value for making the overall temperature rise of 40K, when mounted on a 4-layer circuit board of FR4 t=1.6 mm and DC current is applied.

*4: Saturation rated current : DC current which causes L(0) drop -30 %.

*5: Vibration resistance conditions : Amplitude: 5 mm or less, sweep speed: 1 oct / min, frequency 5-2000 Hz, 3 directions/2 hours each, total 6 hours

*6: The solderability is guaranteed for 1 year only. The product out of expiration date shall not be used.

◆ Within a suitable application, the part's temperature depends on circuit design and certain heat dissipation conditions. This should be double checked in a worst case operation mode. In normal case, the max.standard operating temperature of +160°C should not be exceeded. Please contact for possible to use over 160 °C condition. Temperature up to 180 °C may possibly be used.

Performance characteristics (Reference①)

● Inductance vs DC Current

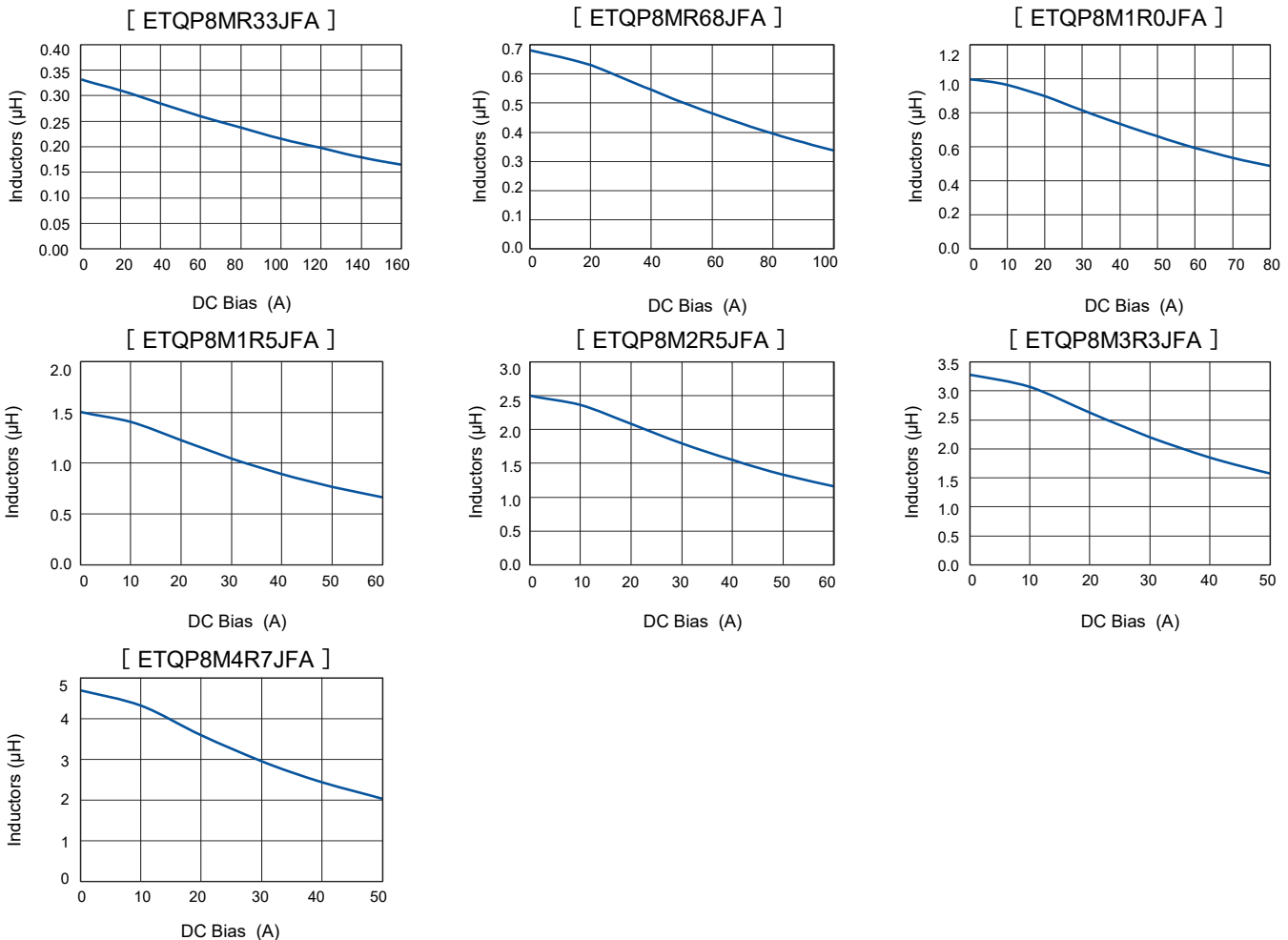

Performance characteristics (Reference②)

● Case Temperature vs DC Current

- PWB condition A : Four-layer PWB (1.6 mm FR4).^{*3}
- - - PWB condition B : Multilayer PWB with high heat dissipation performance.^{*2}

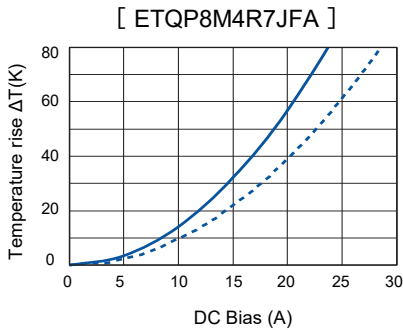
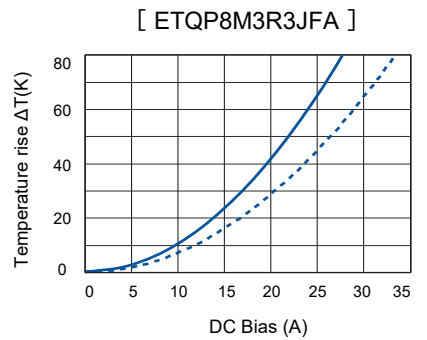
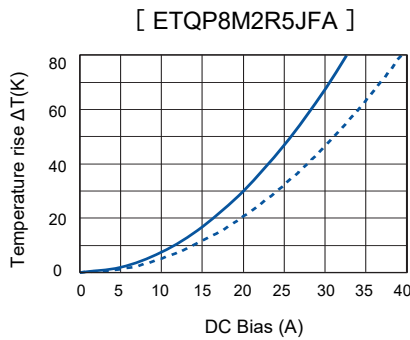
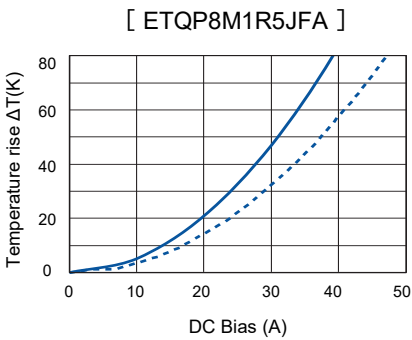
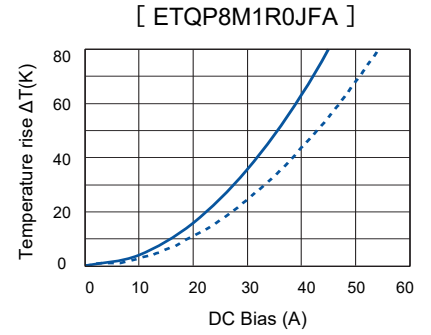
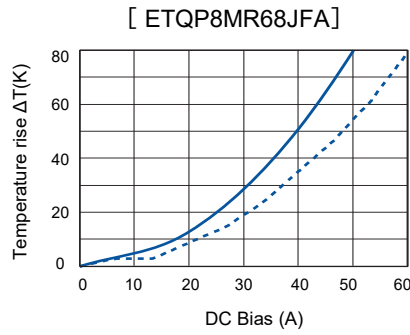
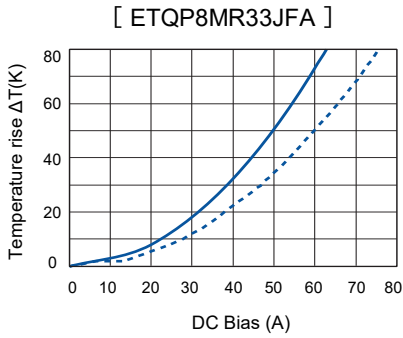

2. PCC-M15A0MF series

Standard parts

Part No.	Inductance ^{*1}		DCR (at 20 °C) (mΩ)		Rated current (A) Typ.		Vibration resistance (G)	MSL	Series [Size L×W×H] (mm)	
	L0 (μH)	Tolerance (%)	Typ. (max.)	Tolerance (%)	ΔT= 40 K ^{*2} () ^{*3}	ΔL= -30 % ^{*4}				
ETQPAMR33JFW	0.33	±20	0.42 [0.48]	±15	83 [69]	103	30	1	PCC-M15A0MF [17.2×15.6×10.5]	
ETQPAMR68JFW	0.68		0.70 [0.77]		(±15)	65 [53]				71
▲ETQPAM1R0JFW	1.0		(0.88 [0.97])			(57 [47])				(52)
▲ETQPAM1R5JFW	1.5		(1.10 [1.21])	(±10)	(52 [43])	(43)				
▲ETQPAM2R5JFW	2.5		(1.70 [1.87])		(42 [34])	(41)				
▲ETQPAM3R3JFW	3.3		(2.40 [2.64])		(35 [29])	(37)				
▲ETQPAM4R7JFW	4.7		(3.10 [3.41])		(31 [26])	(30)				

*1: Measured at 100 kHz

▲ This spec may change because these are under development

*2: The proved current value for making the overall temperature rise of 40K, when mounted on a multi-layer board with high-heat dissipation (heat dissipation constant : approx. 13.8 K/W).

*3: The proved current value for making the overall temperature rise of 40K, when mounted on a 4-layer circuit board of FR4 t=1.6 mm and DC current is applied.

*4: Saturation rated current : DC current which causes L(0) drop -30 %.

*5: Vibration resistance conditions : Amplitude: 5 mm or less, sweep speed: 1 oct / min, frequency 5-2000 Hz, 3 directions/2 hours each, total 6 hours

*6: The solderability is guaranteed for 1 year only. The product out of expiration date shall not be used.

◆ Within a suitable application, the part's temperature depends on circuit design and certain heat dissipation conditions. This should be double checked in a worst case operation mode. In normal case, the max.standard operating temperature of +160°C should not be exceeded. Please contact for possible to use over 160 °C condition. Temperature up to 180 °C may possibly be used.

Performance characteristics (Reference①)

● Inductance vs DC Current

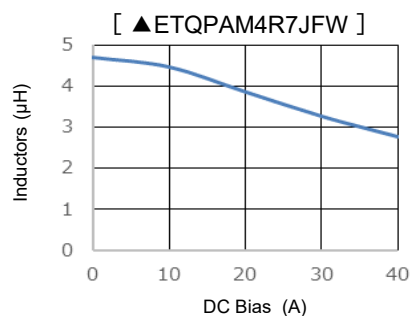
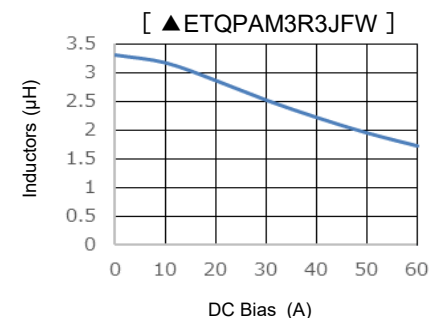
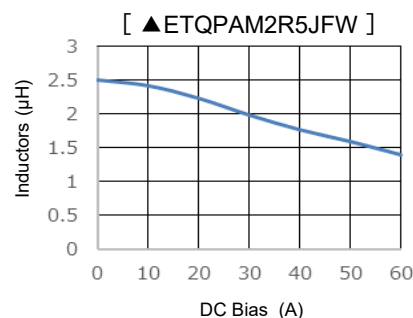
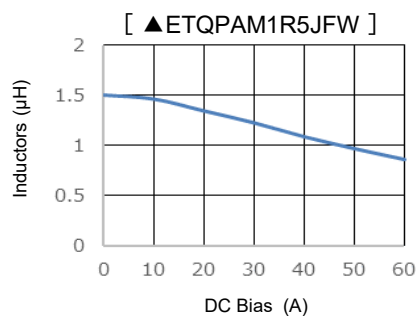
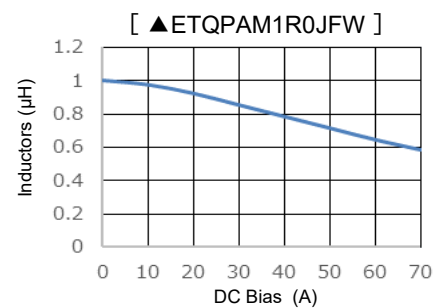
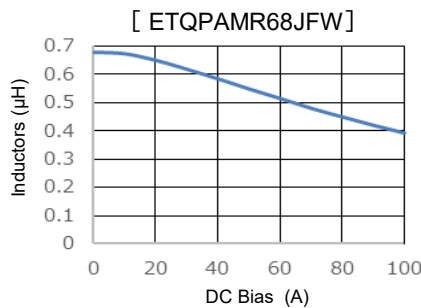
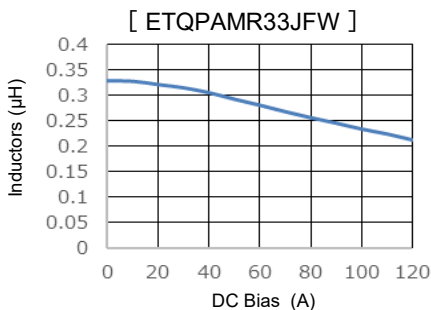

▲ This spec may change because these are under development

Performance characteristics (Reference②)

● Case Temperature vs DC Current

- PWB condition A : Four-layer PWB (1.6 mm FR4).^{*3}
- - - PWB condition B : Multilayer PWB with high heat dissipation performance.^{*2}

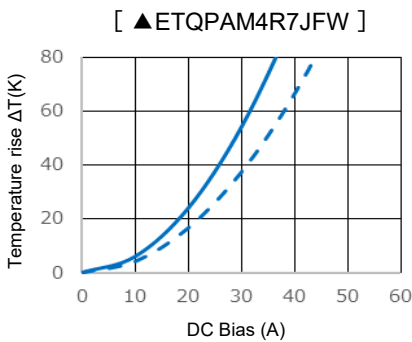
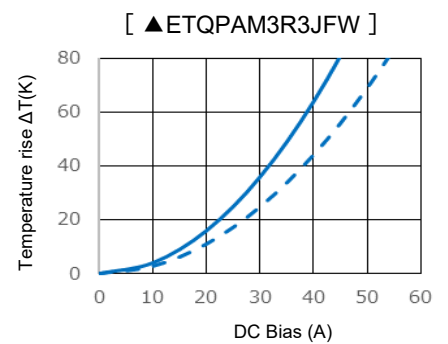
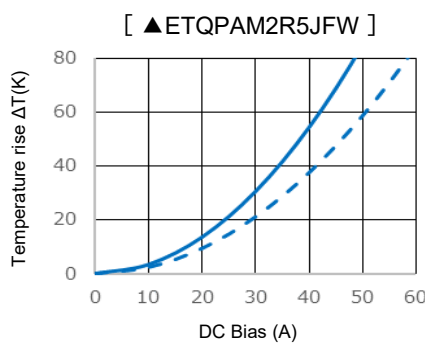
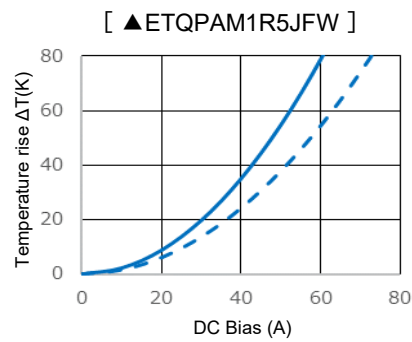
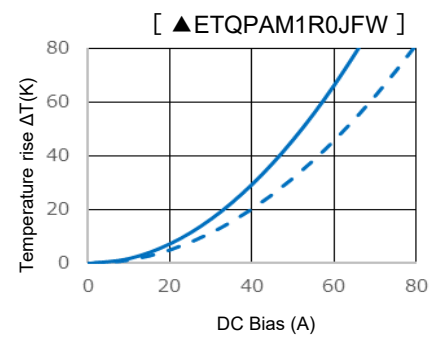
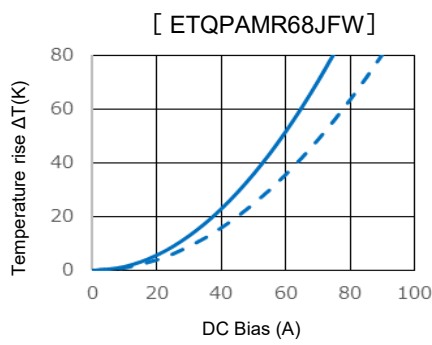
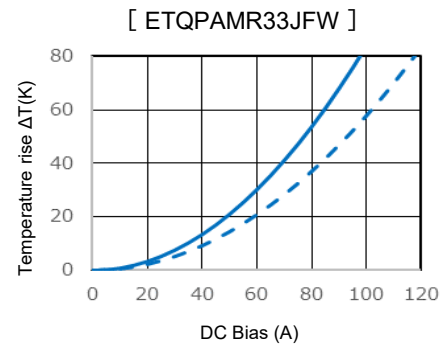

▲ This spec may change because these are under development

Dimensions in mm (not to scale)

Dimensional tolerance unless noted : ± 0.5

- ETQP8MR33JFA
- ETQP8MR68JFA
- ETQP8M1R0JFA
- ETQP8M1R5JFA

- ETQPAMR33JFW
- ETQPAMR68JFW
- ▲ETQPAM1R0JFW
- ▲ETQPAM1R5JFW

- ▲ETQPAM2R5JFW
- ▲ETQPAM3R3JFW
- ▲ETQPAM4R7JFW

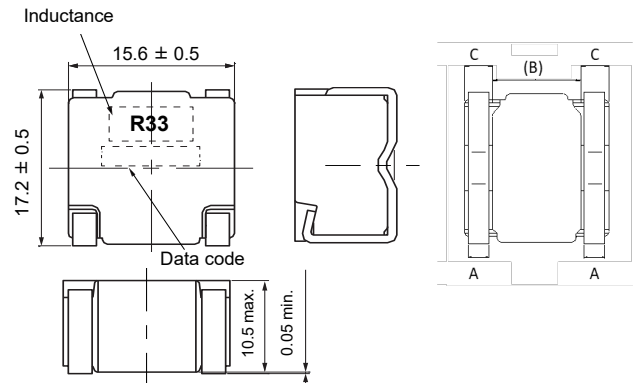
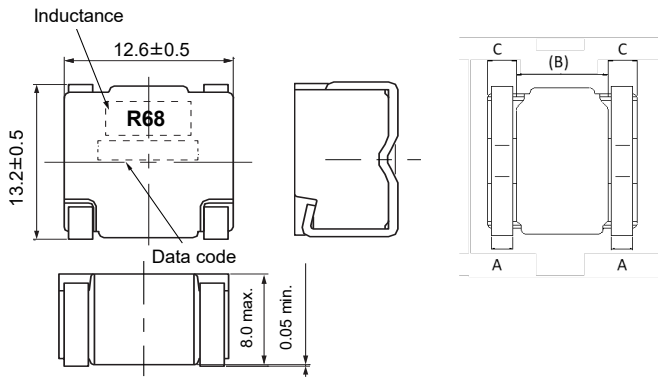

※ The mounting terminal should not protrude from C

※ The mounting terminal should not protrude from C

Unit : mm

Part No.	A	B	C
ETQP8MR33JFA	2.2±0.4	(6.4)	3.10±0.15
ETQP8MR68JFA	2.0±0.4	(7.1)	2.75±0.16
ETQP8M1R0JFA	2.0±0.4	(7.1)	2.75±0.16
ETQP8M1R5JFA	2.0±0.4	(7.1)	2.75±0.16

Unit : mm

Part No.	A	B	C
ETQPAMR33JFW	3.1±0.8	(5.6)	5.0±0.16
ETQPAMR68JFW	2.6±0.8	(5.6)	5.0±0.16
▲ETQPAM1R0JFW	2.6±0.8	(5.6)	5.0±0.16
▲ETQPAM1R5JFW	2.6±0.8	(5.6)	5.0±0.16
▲ETQPAM2R5JFW	(2.2)	(9.2)	(3.2)
▲ETQPAM3R3JFW	(2.2)	(9.2)	(3.2)
▲ETQPAM4R7JFW	(1.5)	(9.2)	(3.2)

▲ This spec may change because these are under development

- ETQP8M2R5JFA
- ETQP8M3R3JFA
- ETQP8M4R7JFA

A : Terminal width

B : Convex part on the bottom of the product

C : Terminal storage portion

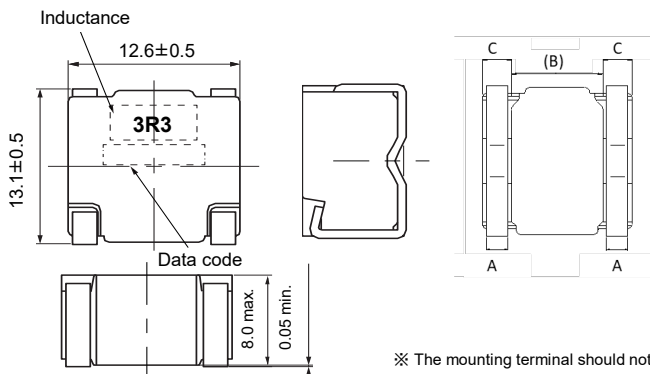

※ The mounting terminal should not protrude from C

Unit : mm

Part No.	A	B	C
ETQP8M2R5JFA	1.8±0.4	(7.7)	2.45±0.10
ETQP8M3R3JFA	1.5±0.4	(8.1)	2.25±0.14
ETQP8M4R7JFA	1.25±0.4	(8.1)	2.25±0.14

Recommended land pattern in mm (not to scale)

Dimensional tolerance unless not

•ETQP8MR33JFA

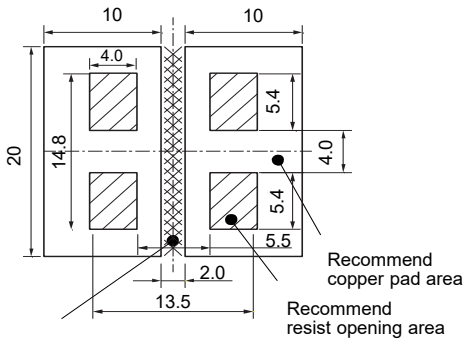

Don't wire this portion with PWB.

•ETQP8M4R7JFA

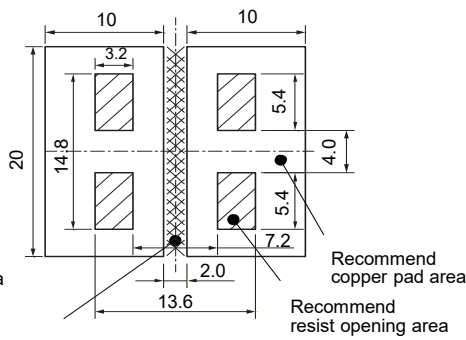

Don't wire this portion with PWB.

•ETQP8M3R3JFA

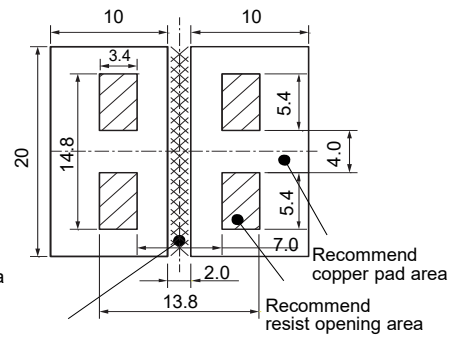

Don't wire this portion with PWB.

•ETQP8M2R5JFA

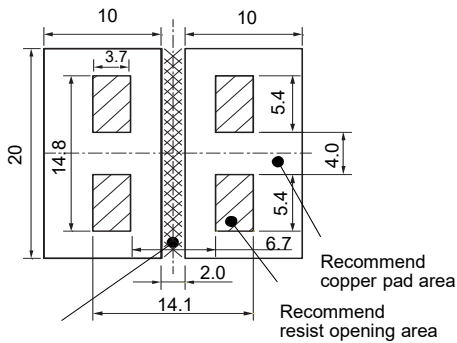

Don't wire this portion with PWB.

•ETQP8MR68JFA
•ETQP8M1R0JFA
•ETQP8M1R5JFA

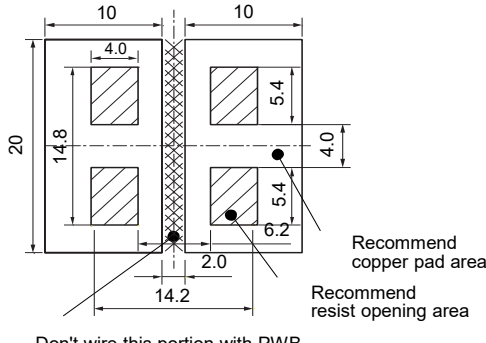

Don't wire this portion with PWB.

•ETQPAMR33JFW
•ETQPAMR68JFW
•▲ETQPAM1R0JFW
•▲ETQPAM1R5JFW

•▲ETQPAM2R5JFW
•▲ETQPAM3R3JFW
•▲ETQPAM4R7JFW

▲ This spec may change because these are under development

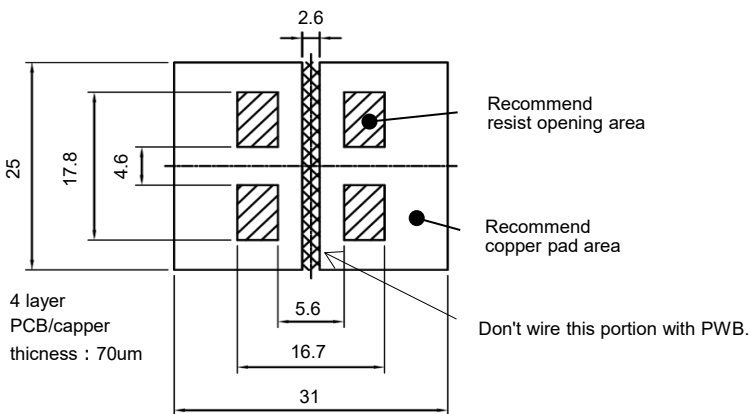

UNit : mm

■ As for soldering conditions and safety precautions (Power choke coils (Automotive grade)), please see data files

Packaging methods (Taping)

- Embossed carrier tape dimensions in mm (not to scale)

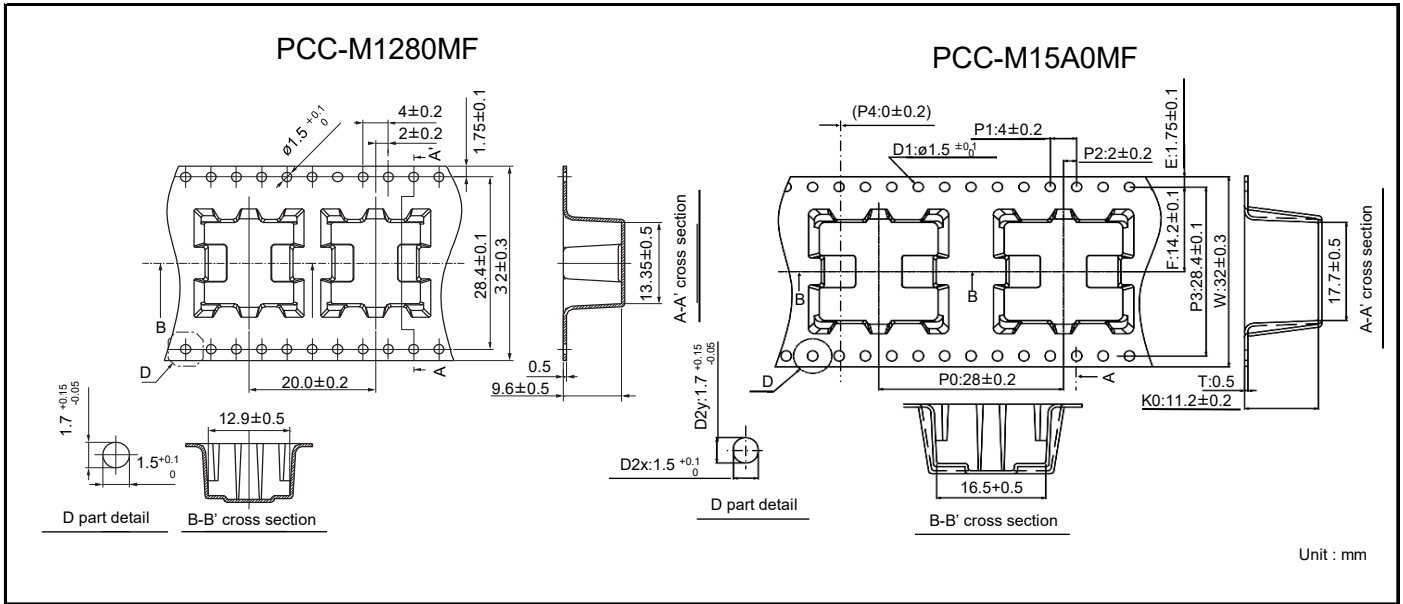

- Taping reel dimensions in mm (not to scale)

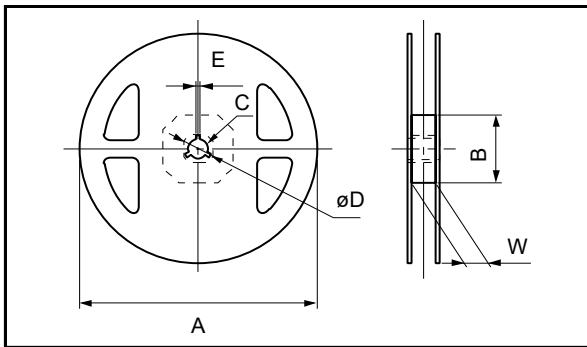

Standard reel dimensions

Series	A	B	C	̸D	E	W
PCC-M1280MF	330	(100)	13	21	2	33.5
PCC-M15A0MF	330	(100)	13	21	2	33.5

Unit : mm

Parts mounting (Taping)

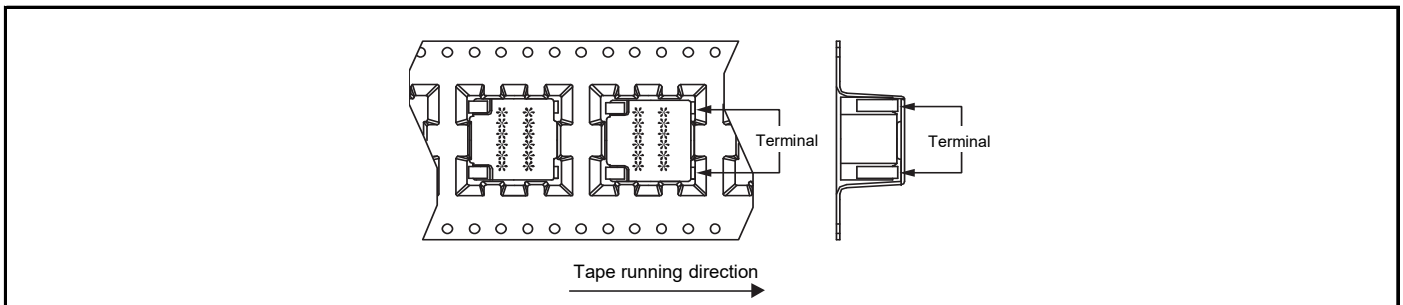

Standard packing quantity / Reel

Series	Part No.	Minimum quantity / Packing unit	Quantity per reel
PCC-M1280MF	ETQP8M□□□JFA	500 pcs / box (2 reels)	250 pcs
PCC-M15A0MF	ETQPAM□□□JFW	200 pcs / box (2 reels)	100 pcs

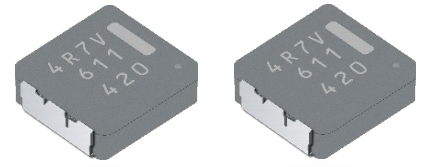

Power Inductors

Power Choke Coil (Automotive Grade)

PCC-M0530M-LP, PCC-M0630M-LP series

PCC-M0840M-LP, PCC-M1040M-LP series

High heat resistance and high reliability using metal composite core (MC)

Industrial property : Patents 3 (Registered 2 / Pending 1)

Features

- High heat resistance : Operation up to 155 °C including self-heating. (180 °C short time*)
* Please contact for possible to use over 155 °C condition. Temperature up to 180 °C may possibly be used.
- Low profile : 3 mm max. height (PCC-M0530M-LP, PCC-M0630M-LP)
4 mm max. height (PCC-M0840M-LP, PCC-M1040M-LP)
- SMD type
- High-reliability : High vibration resistance as result of newly developed integral construction ;
under severe reliability conditions of automotive and other strenuous applications
- High bias current : Excellent inductance stability using ferrous alloy magnetic material
- Temp. stability : Excellent inductance stability over broad temp. range
- Low audible (buzz) noise : A gapless structure achieved with metal composite core
- High efficiency : Low DC resistance of winding and low eddy-current loss of the core
- Shielded construction
- AEC-Q200 compliant
- RoHS compliant

Recommended applications

- Noise filter for various drive circuitry requiring high temp. operation and peak current handling capability
- Boost-Converter, Buck-Converter DC/DC

Standard packing quantity (Minimum quantity/Packing unit)

- 4,000 pcs/box (2 reel) : PCC-M0530M-LP, M0630M-LP
- 1,000 pcs/box (2 reel) : PCC-M0840M-LP, M1040M-LP

Explanation of part numbers

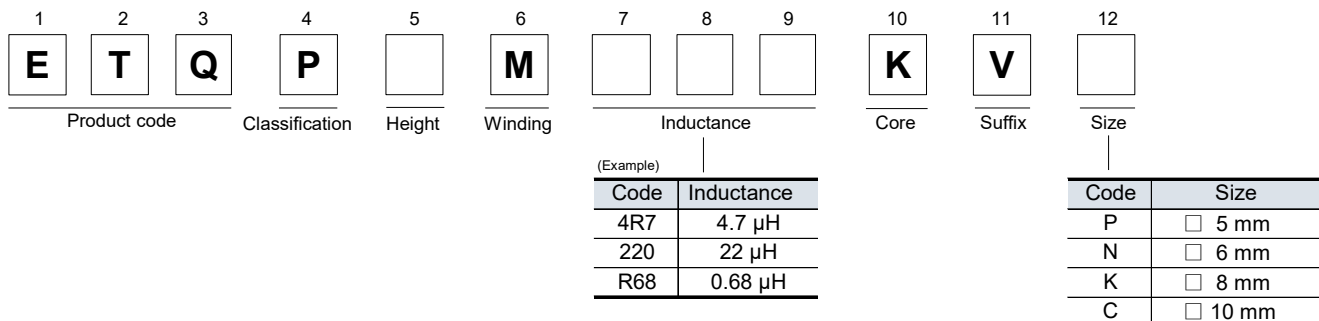

Temperature rating

Operating temperature range		Tc : -55 °C to +155 °C (Including self-temperature rise)
Storage condition	After PWB mounting	
	Before PWB mounting	Ta : -5 °C to +35 °C 85%RH max.

1. PCC-M0530M-LP series (ETQP3M□□□KVP)

Standard parts

Part No.	Inductance *1		DCR (at 20 °C) (mΩ)		Rated current (A) Typ.		Vibration resistance (G) *5	MSL *6	Series [Size L×W×H] (mm)
	L0 (μH)	Tolerance (%)	Typ. (max.)	Tolerance (%)	$\Delta T = 40 \text{ K}^{*2}$ () ^{*3}	$\Delta L =$ -30 % ^{*4}			
ETQP3M220KVP	22.0	±20	165.0 (181.5)	±10	2.2(1.8)	2.8	30.0	1	PCC-M0530M-LP [5.0×5.5×3.0]
ETQP3M100KVP	10.0		96.0 (105.60)		2.9 (2.4)	4.2			
ETQP3M6R8KVP	6.8		65.7 (72.27)		3.5 (2.9)	6.1			
ETQP3M4R7KVP	4.7		45.6 (50.16)		4.1(3.4)	6.7			
ETQP3M3R3KVP	3.3		27.3 (30.03)		5.4 (4.4)	8.0			
ETQP3M2R2KVP	2.2		20.0 (22.00)		6.3 (5.2)	10.1			
ETQP3M1R5KVP	1.5		12.0 (13.20)		8.1 (6.7)	12.0			
ETQP3M1R0KVP	1.0		9.6 (10.56)		9.0 (7.5)	14.1			
ETQP3MR68KVP	0.68		7.6 (8.36)		10.2 (8.4)	15.9			
ETQP3MR47KVP	0.47		5.8 (6.38)		11.6 (9.6)	17.9			
ETQP3MR33KVP	0.33	4.85 (5.34)	12.7 (10.6)	21.8					

*1: Measured at 100 kHz

*2: The proved current value for making the overall temperature rise of 40K, when mounted on a multi-layer board with high-heat dissipation (heat dissipation constant 5.5 x 5.0 x 3.0 mm : approx. 51 K/W).

*3: The proved current value for making the overall temperature rise of 40K, when mounted on a 4-layer circuit board of FR4 t=1.6 mm and DC current is applied.

*4: Saturation rated current : DC current which causes L(0) drop -30 %.

*5: Vibration resistance conditions : Amplitude: 5 mm or less, sweep speed: 1 oct / min, frequency 5-2000 Hz, 3 directions / 4 hours each, total 12 hours

*6: The solderability is guaranteed for 1 year only. The product out of expiration date shall not be used.

◆ Within a suitable application, the part's temperature depends on circuit design and certain heat dissipation conditions. This should be double checked in a worst case operation mode. In normal case, the max. standard operating temperature of +155°C should not be exceeded. Please contact for possible to use over 155 °C condition. Temperature up to 180 °C may possibly be used.

Performance characteristics (Reference①- 1)

● Inductance vs DC Current

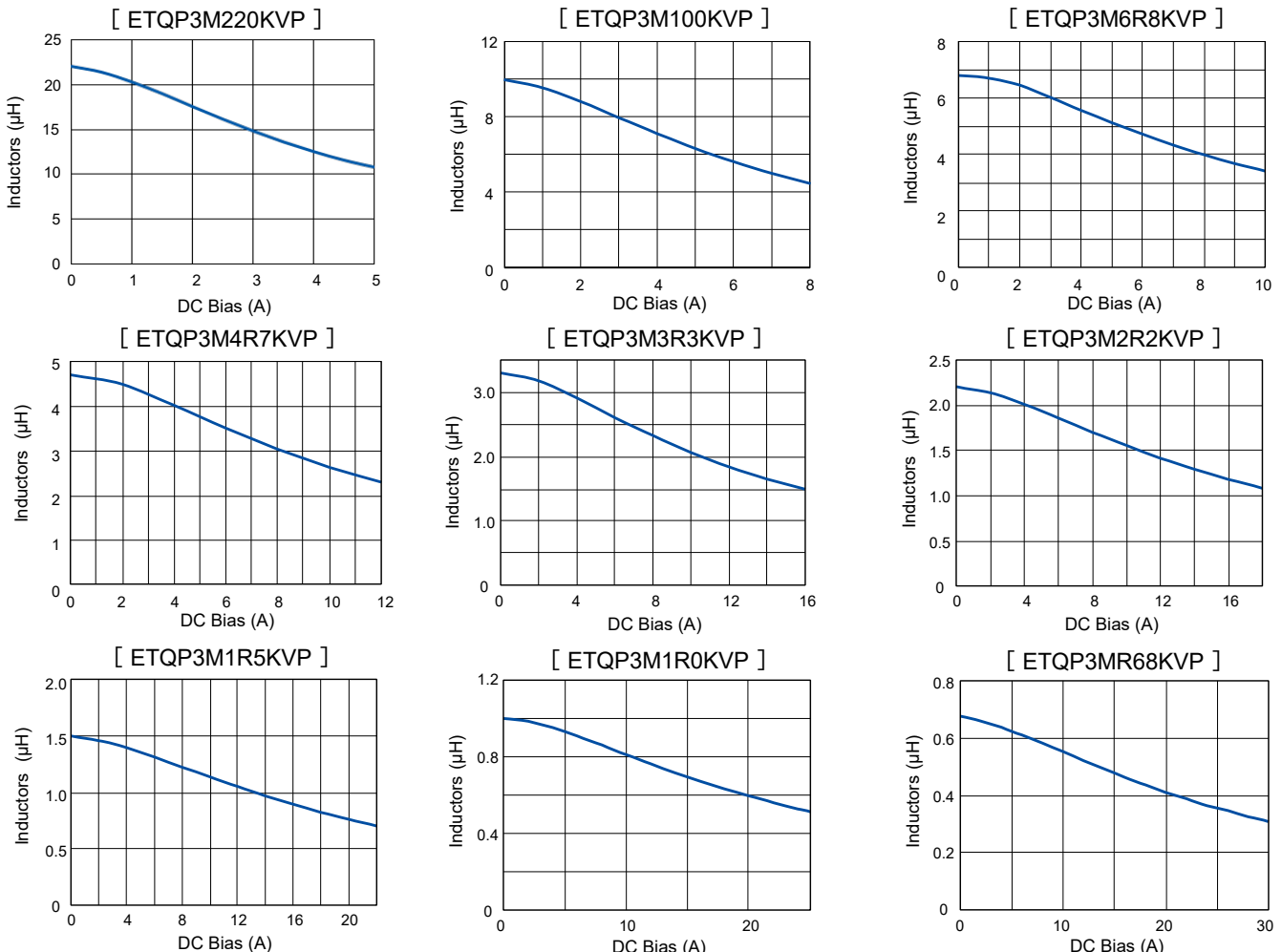

Performance characteristics (Reference①)-2

● Inductance vs DC Current

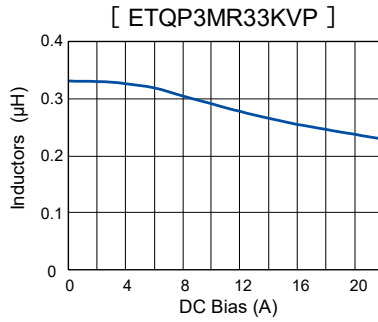
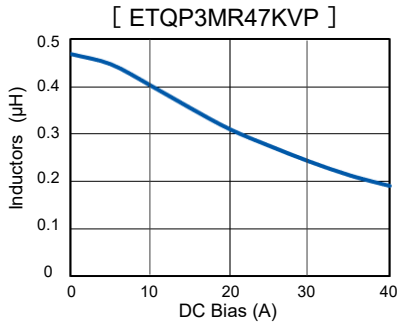

Performance characteristics (Reference②)

● Case Temperature vs DC Current

— PWB condition A : Four-layer PWB (1.6 mm FR4).^{*3}

--- PWB condition B : Multilayer PWB with high heat dissipation performance.^{*2}

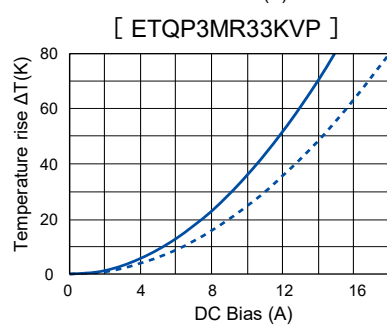
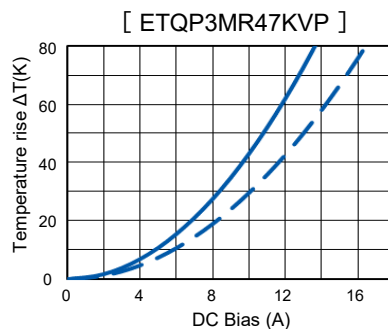
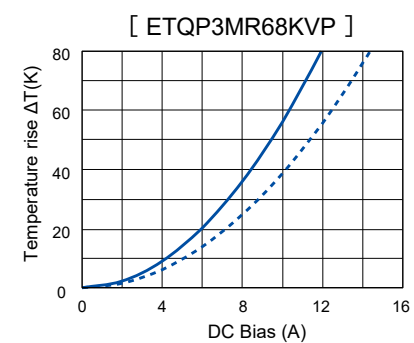
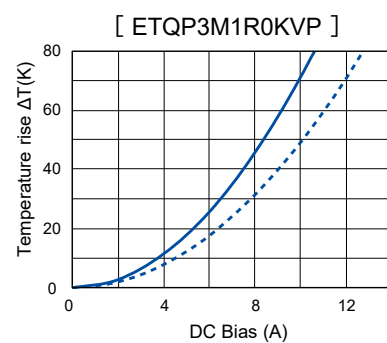
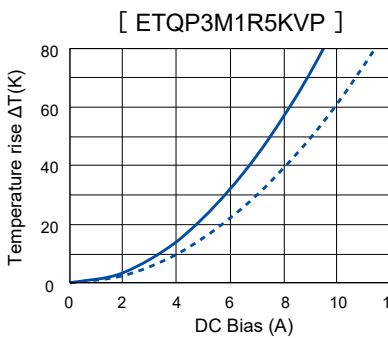
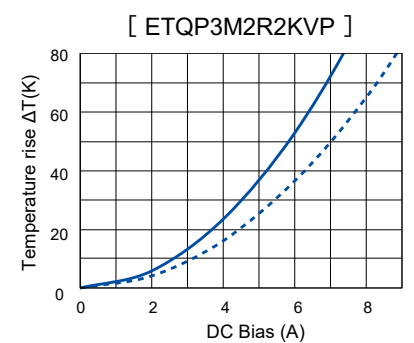
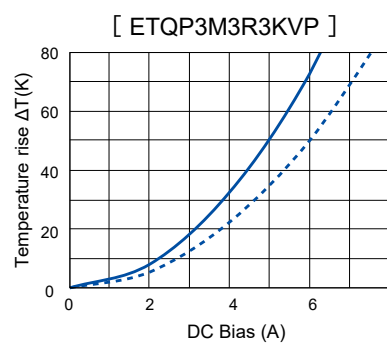
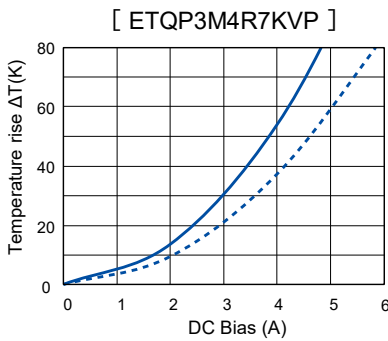
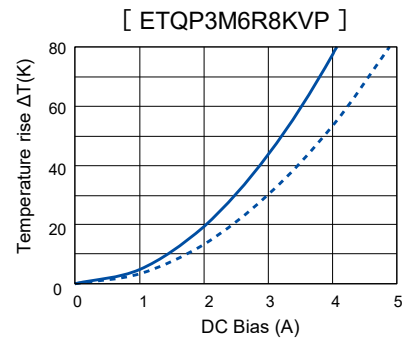
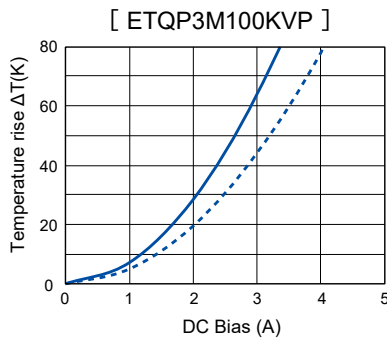
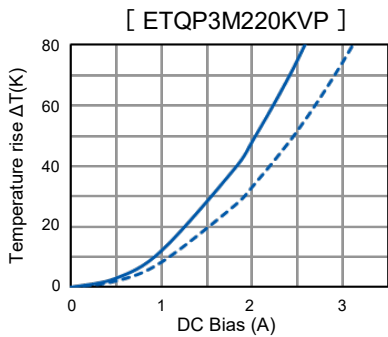

2. PCC-M0630M-LP series (ETQP3M□□□KVN)

Standard parts

Part No.	Inductance *1		DCR (at 20 °C) (mΩ)		Rated current (A) Typ.		Vibration resistance (G) *5	MSL *6	Series [Size L×W×H] (mm)
	L0 (μH)	Tolerance (%)	Typ. (max.)	Tolerance (%)	ΔT= 40 K*2 ()*3	ΔL= -30 %*4			
ETQP3M330KVN	33.0	±20	206.0 (226.60)	±10	2.1 (1.7)	3.0	30.0	1	PCC-M0630M-LP [6.0×6.4×3.0]
ETQP3M220KVN	22.0		128.0 (140.80)		2.7 (2.2)	4.3			
ETQP3M150KVN	15.0		99.2 (109.12)		3.0 (2.5)	5.1			
ETQP3M100KVN	10.0		71.0 (78.10)		3.6 (2.9)	5.8			
ETQP3M6R8KVN	6.8		45.6 (50.16)		4.5 (3.6)	8.1			
ETQP3M4R7KVN	4.7		29.0 (31.90)		5.6 (4.6)	9.8			
ETQP3M3R3KVN	3.3		24.1 (26.51)		6.1 (5.0)	11.5			
ETQP3M2R2KVN	2.2		14.5 (15.95)		7.9 (6.5)	12.8			
ETQP3M1R5KVN	1.5		11.0 (12.10)		9.1 (7.4)	14.2			
ETQP3M1R0KVN	1.0		6.2 (6.82)		12.1 (9.9)	16.0			
ETQP3MR68KVN	0.68	5.2 (5.72)	13.2 (10.8)	20.2					

*1: Measured at 100 kHz

*2: The proved current value for making the overall temperature rise of 40K, when mounted on a multi-layer board with high-heat dissipation (heat dissipation constant 6.5 x 6.0 x 3.0 mm : approx. 44 K/W).

*3: The proved current value for making the overall temperature rise of 40K, when mounted on a 4-layer circuit board of FR4 t=1.6 mm and DC current is applied.

*4: Saturation rated current : DC current which causes L(0) drop -30 %.

*5: Vibration resistance conditions : Amplitude: 5 mm or less, sweep speed: 1 oct / min, frequency 5-2000 Hz, 3 directions / 4 hours each, total 12 hours

*6: The solderability is guaranteed for 1 year only. The product out of expiration date shall not be used.

◆ Within a suitable application, the part's temperature depends on circuit design and certain heat dissipation conditions. This should be double checked in a worst case operation mode. In normal case, the max.standard operating temperature of +155°C should not be exceeded. Please contact for possible to use over 155 °C condition. Temperature up to 180 °C may possibly be used.

Performance characteristics (Reference①)

● Inductance vs DC Current

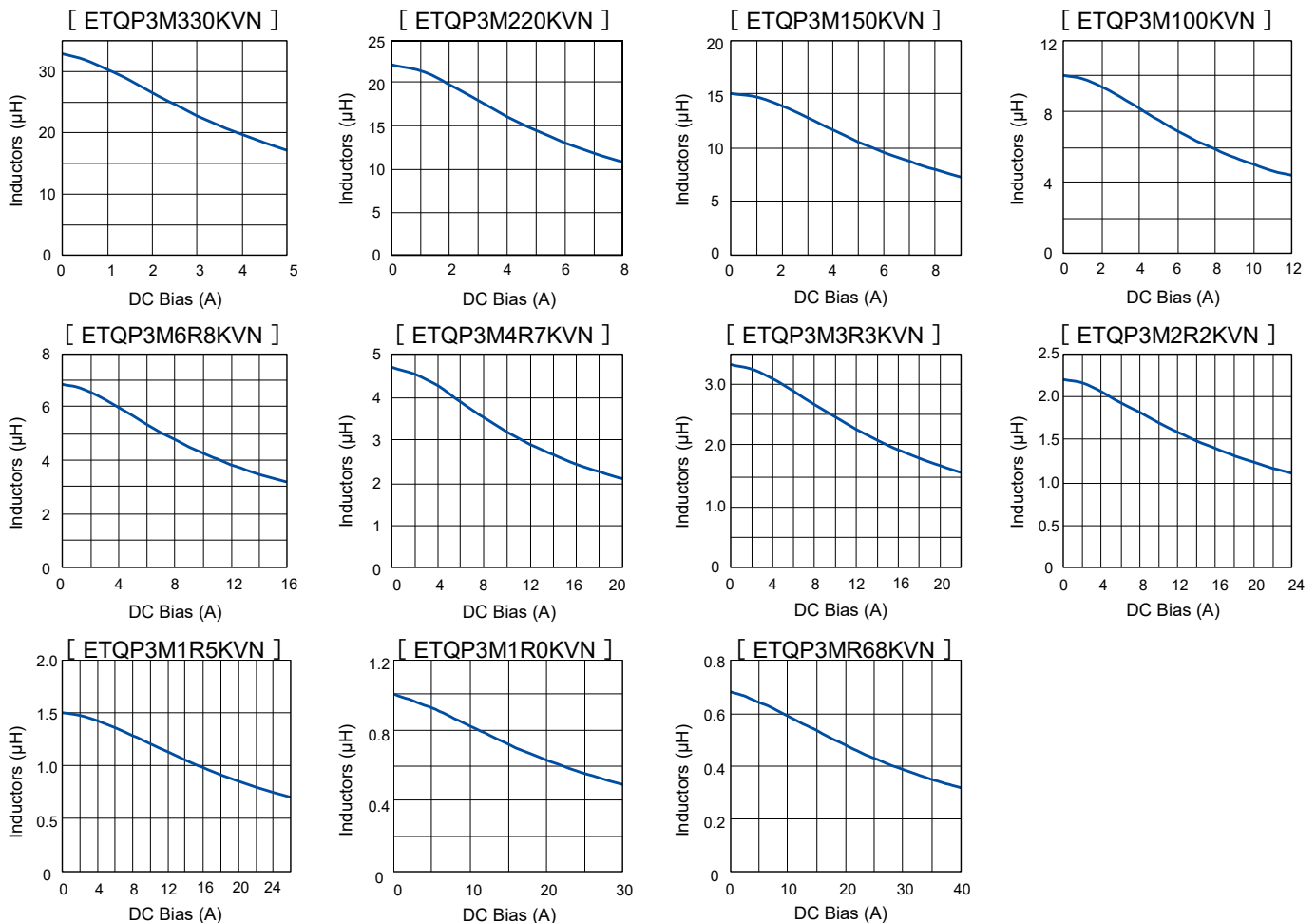

Performance characteristics (Reference②)

● Case Temperature vs DC Current

- PWB condition A : Four-layer PWB (1.6 mm FR4).^{*3}
- - - PWB condition B : Multilayer PWB with high heat dissipation performance.^{*2}

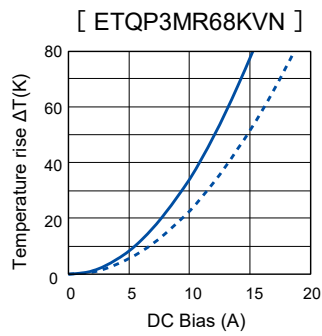
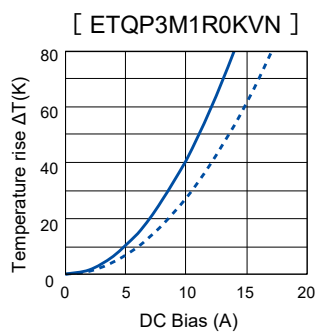
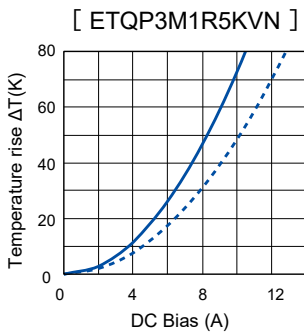
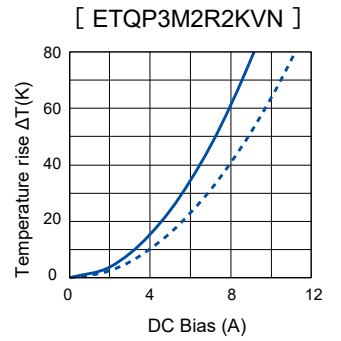
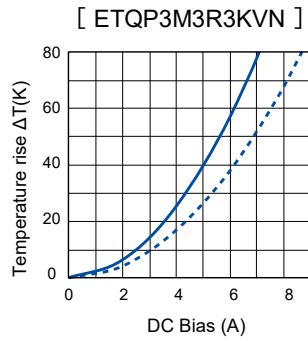
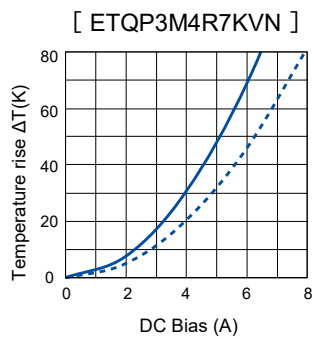
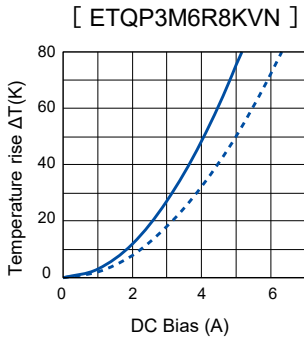
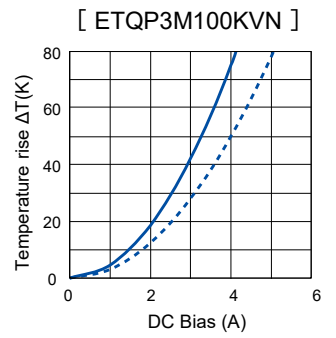
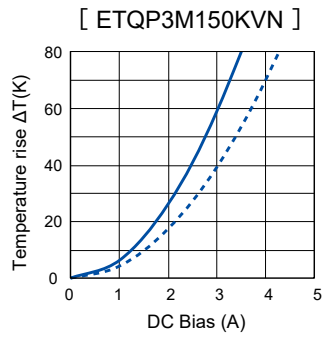
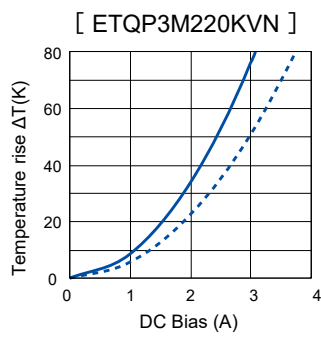
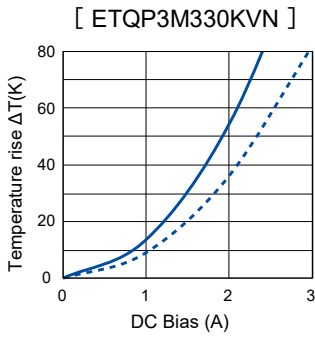

3. PCC-M0840M-LP series (ETQP4M□□□KVK)

Standard parts

Part No.	Inductance *1		DCR (at 20 °C) (mΩ)		Rated current (A) Typ.		Vibration resistance (G) *5	MSL *6	Series [Size L×W×H] (mm)
	L0 (μH)	Tolerance (%)	Typ. (max.)	Tolerance (%)	ΔT= 40 K*2 ()*3	ΔL= -30 %*4			
ETQP4M330KVK	33.0	±20	118.0 (129.80)	±10	3.1 (2.6)	4.7	5.0	1	PCC-M0840M-LP [8.0×8.4×4.0]
ETQP4M220KVK	22.0		78.4 (86.24)		3.8 (3.2)	6.7			
ETQP4M150KVK	15.0		55.0 (60.50)		4.5 (3.8)	7.7			
ETQP4M100KVK	10.0		41.6 (45.76)		5.2 (4.4)	9.1			
ETQP4M6R8KVK	6.8		23.5 (25.85)		6.9 (5.9)	11.0			
ETQP4M4R7KVK	4.7		16.1 (17.71)		8.3 (7.1)	15.1			
ETQP4M3R3KVK	3.3		14.1 (15.51)		8.9 (7.6)	17.4			
ETQP4M2R2KVK	2.2		8.5 (9.35)		11.4 (9.8)	20.4			
ETQP4M1R5KVK	1.5		4.9 (5.39)		15.1 (12.8)	22.5			
ETQP4M1R0KVK	1.0		3.7 (4.07)		17.3 (14.8)	24.4			
ETQP4MR68KVK	0.68	2.92 (3.21)	19.5 (16.6)	29.0					

*1: Measured at 100 kHz

*2: The proved current value for making the overall temperature rise of 40K, when mounted on a multi-layer board with high-heat dissipation (heat dissipation constant 8.5×8.0×4.0 mm : approx. 36 K/W).

*3: The proved current value for making the overall temperature rise of 40K, when mounted on a 4-layer circuit board of FR4 t=1.6 mm and DC current is applied.

*4: Saturation rated current : DC current which causes L(0) drop -30 %.

*5: Vibration resistance conditions : Amplitude: 5 mm or less, sweep speed: 1 oct / min, frequency 5-2000 Hz, 3 directions / 4 hours each, total 12 hours

*6: The solderability is guaranteed for 1 year only. The product out of expiration date shall not be used.

◆ Within a suitable application, the part's temperature depends on circuit design and certain heat dissipation conditions. This should be double checked in a worst case operation mode. In normal case, the max.standard operating temperature of +155°C should not be exceeded. Please contact for possible to use over 155 °C condition. Temperature up to 180 °C may possibly be used.

Performance characteristics (Reference①)

● Inductance vs DC Current

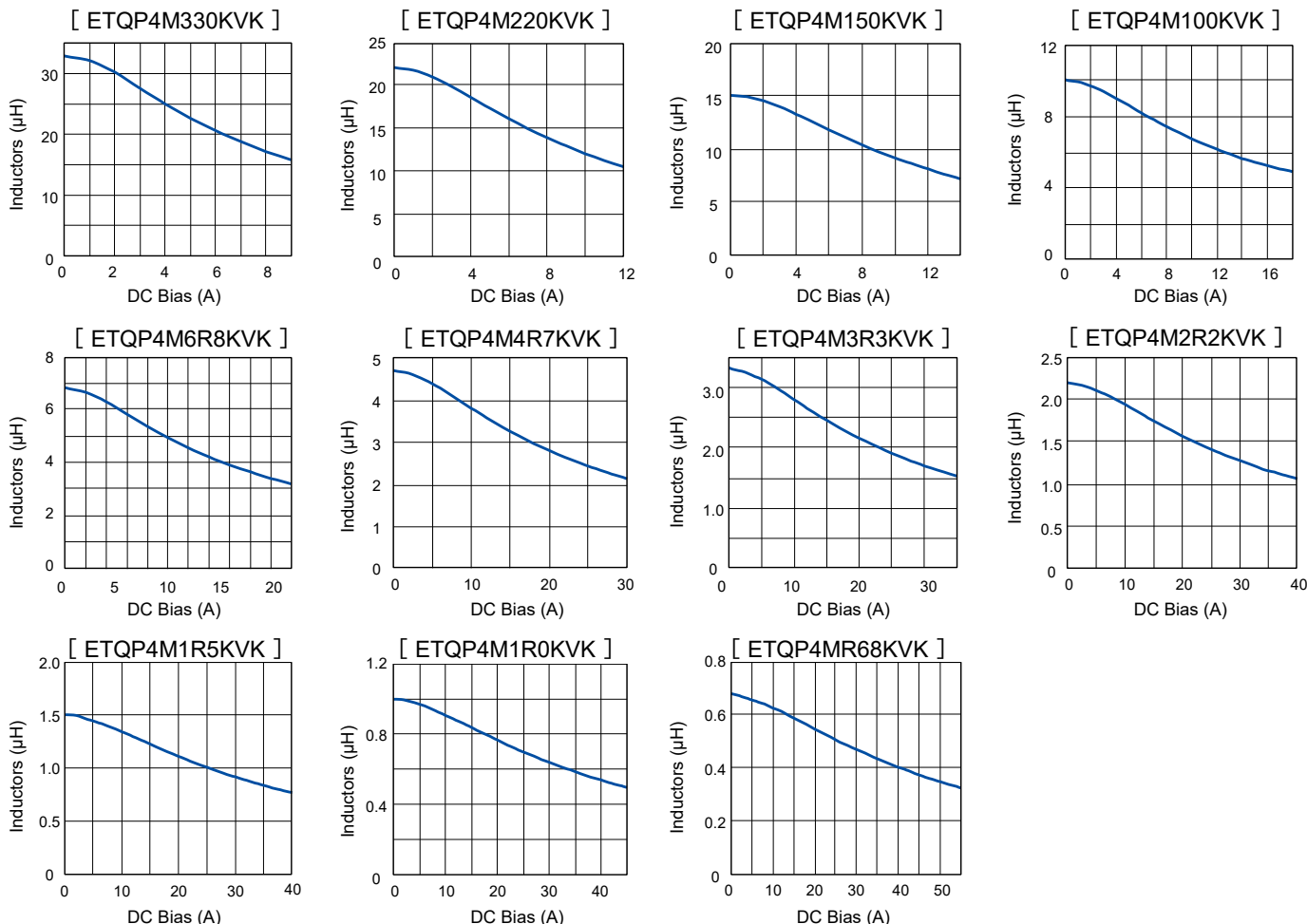

Performance characteristics (Reference②)

● Case Temperature vs DC Current

- PWB condition A : Four-layer PWB (1.6 mm FR4).^{*3}
- - - PWB condition B : Multilayer PWB with high heat dissipation performance.^{*2}

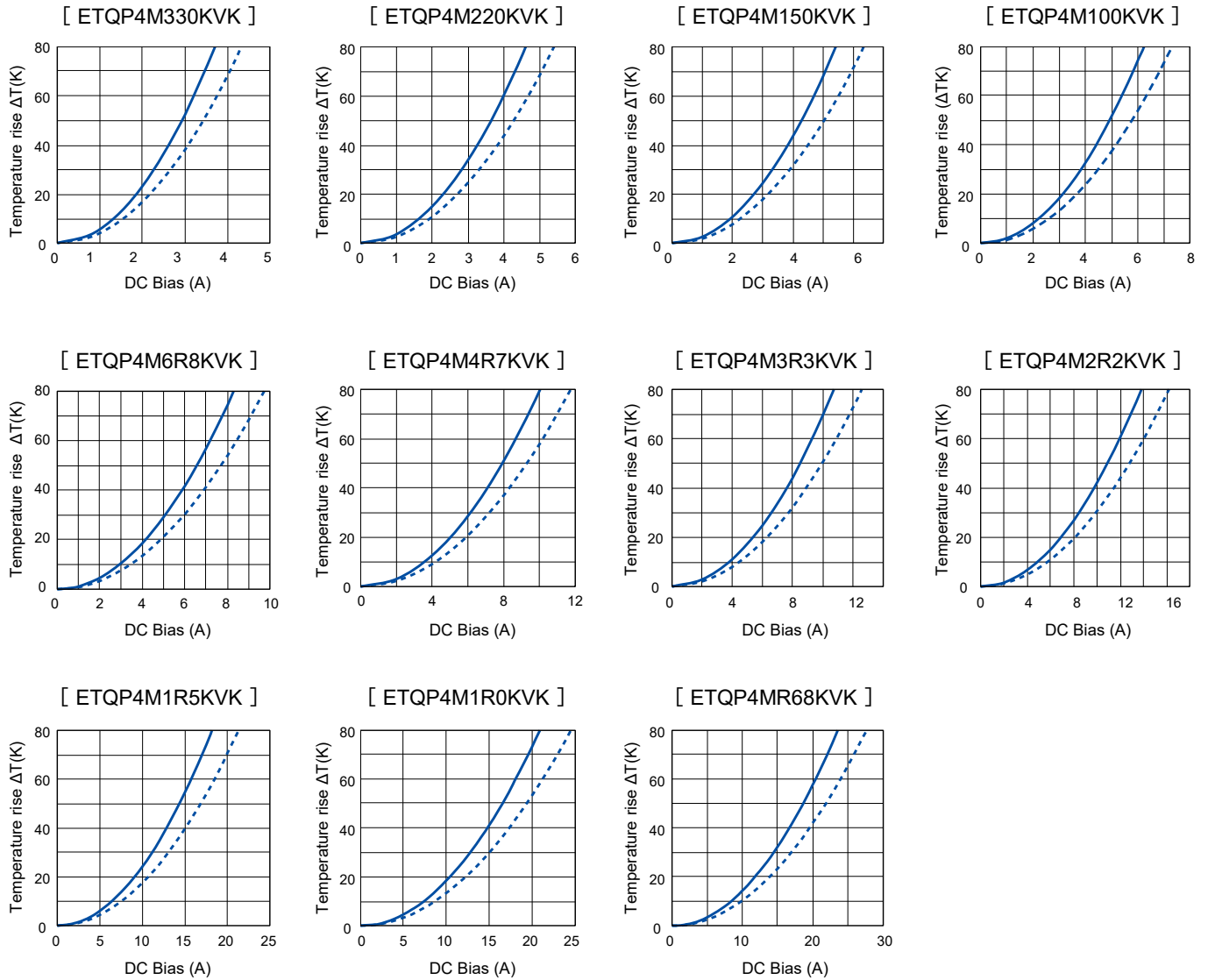

4. PCC-M1040M-LP series (ETQP4M□□□KVC)

Standard parts

Part No.	Inductance *1		DCR (at 20 °C) (mΩ)		Rated current (A) Typ.		Vibration resistance (G) *5	MSL *6	Series [Size L×W×H] (mm)
	L0 (μH)	Tolerance (%)	Typ. (max.)	Tolerance (%)	ΔT= 40 K*2 ()*3	ΔL= -30 %*4			
ETQP4M101KVC	100.0	±20	242.0 (266.20)	±10	2.5 (2.0)	3.5	5.0	1	PCC-M1040M-LP [10.0×10.7×4.0]
ETQP4M680KVC	68.0		178.4 (196.24)		2.9 (2.4)	4.7			
ETQP4M470KVC	47.0		132.0 (145.20)		3.4 (2.8)	4.7			
ETQP4M330KVC	33.0		84.6 (93.06)		4.2 (3.4)	5.6			
ETQP4M220KVC	22.0		60.0 (66.00)		5.0 (4.1)	7.4			
ETQP4M150KVC	15.0		37.0 (40.70)		6.3 (5.2)	9.2			
ETQP4M100KVC	10.0		25.4 (27.94)		7.6 (6.3)	10.8			
ETQP4M6R8KVC	6.8		18.5 (20.35)		8.9 (7.4)	12.1			
ETQP4M4R7KVC	4.7		12.3 (13.53)		11.2 (9.2)	13.9			
ETQP4M3R3KVC	3.3		9.4 (10.34)		12.6 (10.3)	17.1			
ETQP4M2R2KVC	2.2		6.8 (7.48)		14.8 (12.1)	21.0			
ETQP4M1R5KVC	1.5		4.9 (5.39)		17.4 (14.3)	25.0			
ETQP4M1R0KVC	1.0		2.6 (2.86)		23.9 (19.6)	34.6			

*1: Measured at 100 kHz

*2: The proved current value for making the overall temperature rise of 40K, when mounted on a multi-layer board with high-heat dissipation (heat dissipation constant 10.7×10.0×4.0 mm : approx. 27 K/W).

*3: The proved current value for making the overall temperature rise of 40K, when mounted on a 4-layer circuit board of FR4 t=1.6 mm and DC current is applied.

*4: Saturation rated current : DC current which causes L(0) drop -30 %.

*5: Vibration resistance conditions : Amplitude: 5 mm or less, sweep speed: 1 oct / min, frequency 5-2000 Hz, 3 directions / 4 hours each, total 12 hours

*6: The solderability is guaranteed for 1 year only. The product out of expiration date shall not be used.

◆ Within a suitable application, the part's temperature depends on circuit design and certain heat dissipation conditions. This should be double checked in a worst case operation mode. In normal case, the max.standard operating temperature of +155°C should not be exceeded. Please contact for possible to use over 155 °C condition. Temperature up to 180 °C may possibly be used.

Performance characteristics (Reference ①)

● Inductance vs DC Current

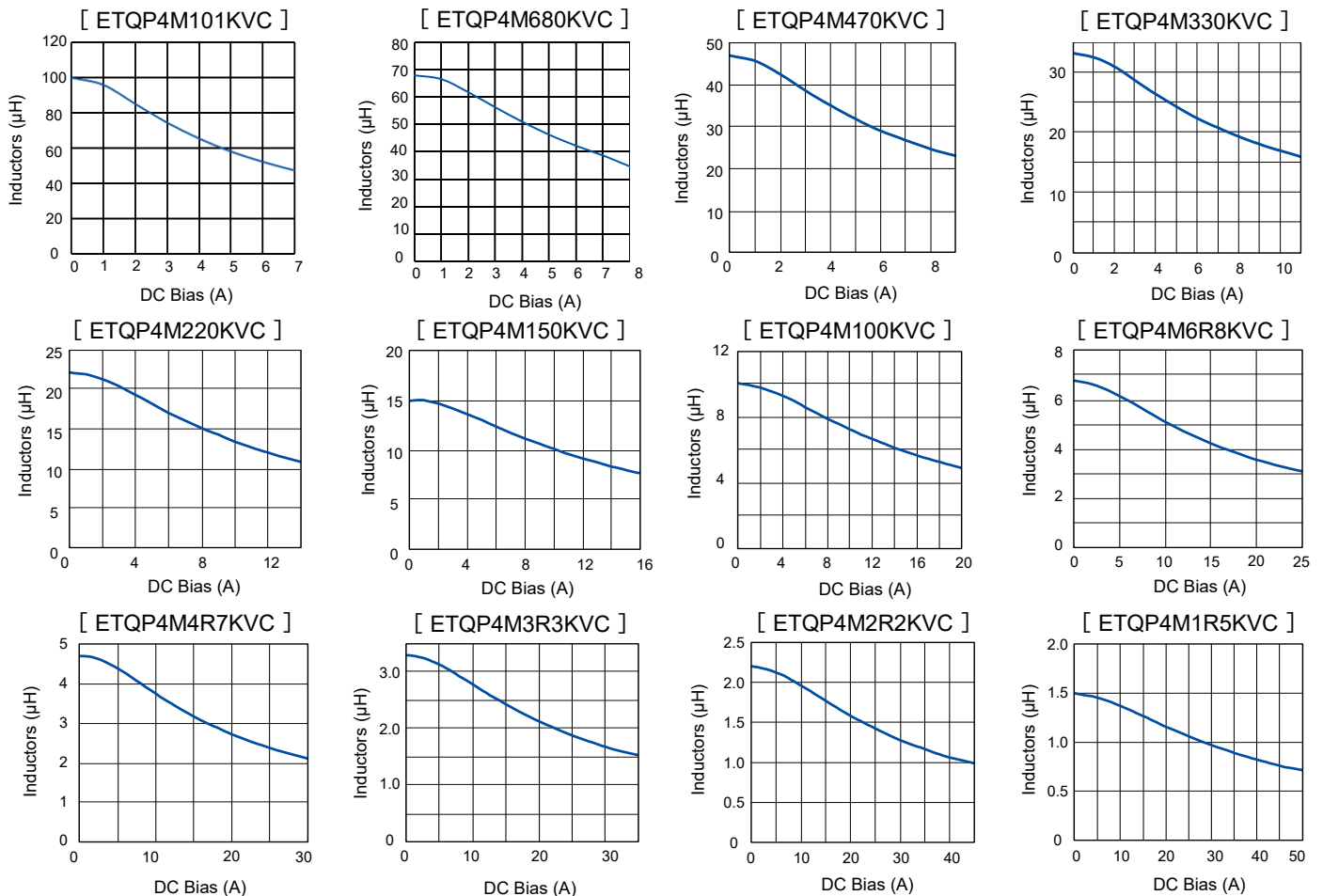

Performance characteristics (Reference①)

● Inductance vs DC Current

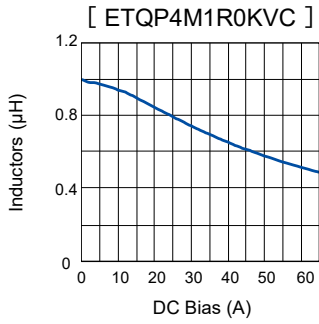

Performance characteristics (Reference②)

● Case Temperature vs DC Current

PWB condition A : Four-layer PWB (1.6 mm FR4).^{*3}

--- PWB condition B : Multilayer PWB with high heat dissipation performance.^{*2}

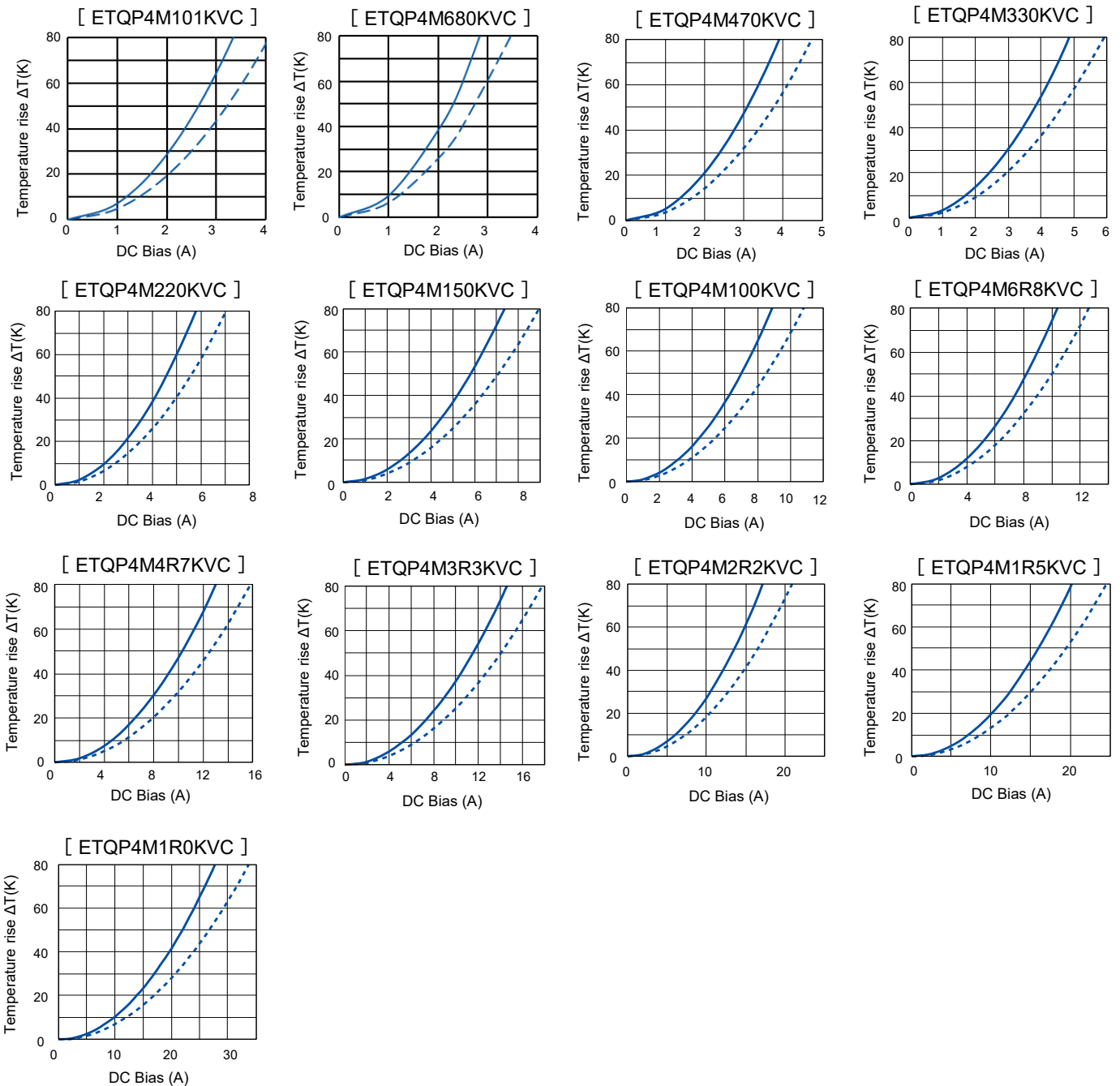

Dimensions in mm (not to scale)

Dimensional tolerance unless noted : ± 0.5

Series PCC-M0530M-LP

(ETQP3M□□□KVP)

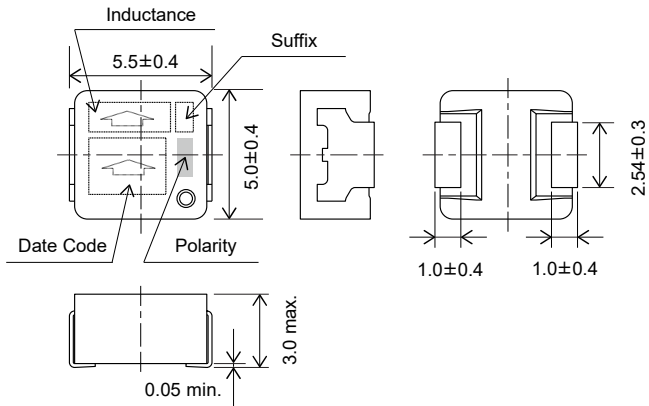

Series PCC-M0630M-LP

(ETQP3M□□□KVN)

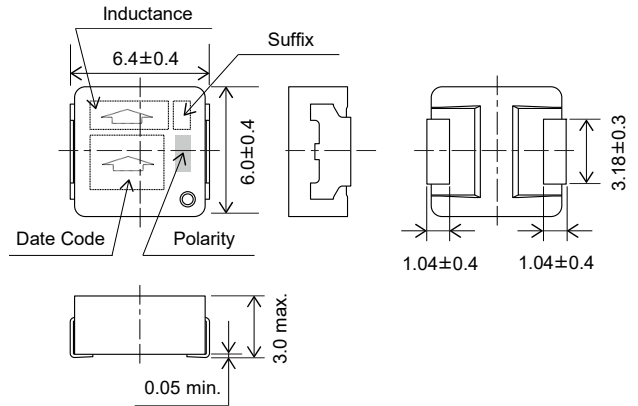

Series PCC-M0840M-LP

(ETQP4M□□□KVK)

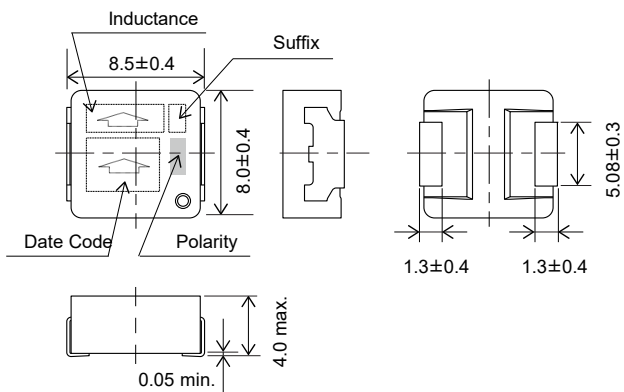

Series PCC-M1040M-LP

(ETQP4M□□□*KVC) *Exemption 1R0

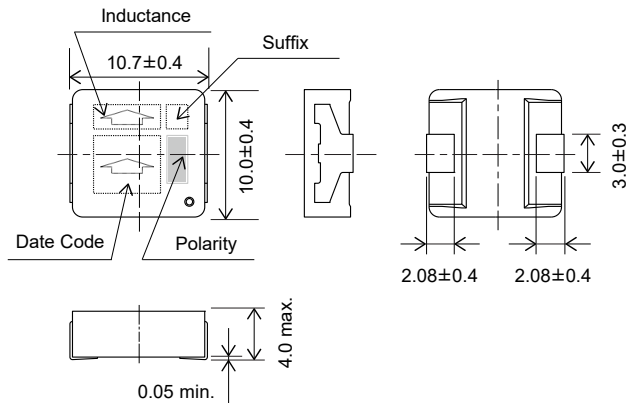

Series PCC-M1040M-LP

(ETQP4M1R0KVC)

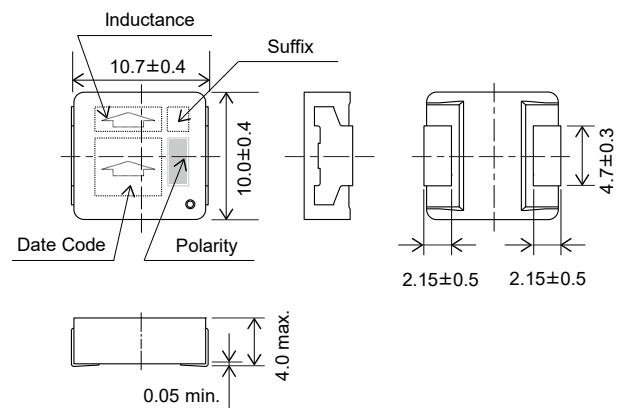

Unit : mm

Recommended land pattern in mm (not to scale)

Dimensional tolerance unless noted : ± 0.5

Series PCC-M0530M-LP
(ETQP3M□□□KVP)

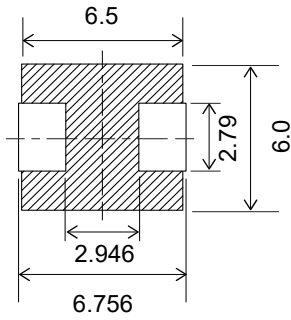

Series PCC-M0630M-LP
(ETQP3M□□□KVN)

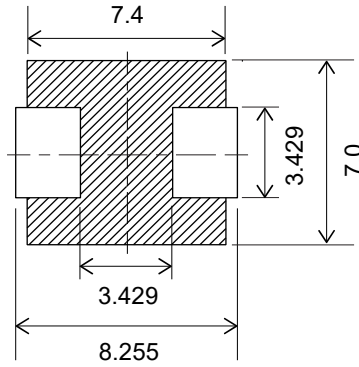

Series PCC-M0840M-LP
(ETQP4M□□□KVK)

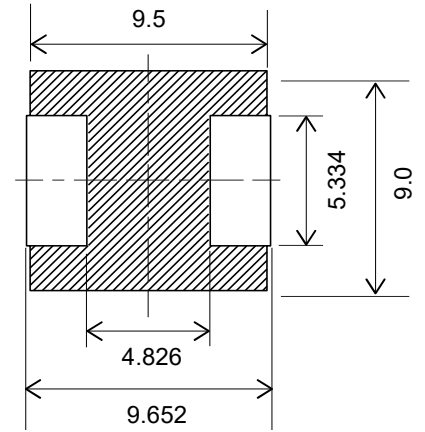

Series PCC-M1040M-LP
(ETQP4M□□□*KVC)*Exemption 1R0

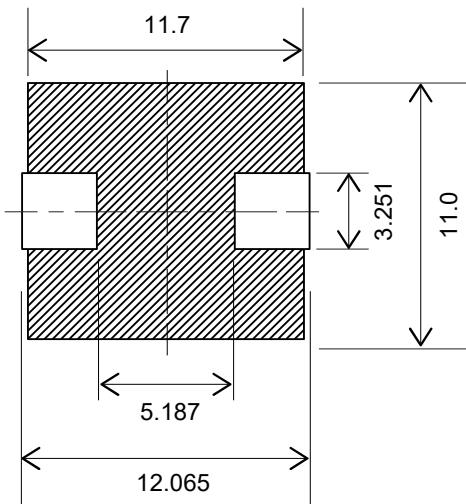

Series PCC-M1040M-LP
(ETQP4M1R0KVC)

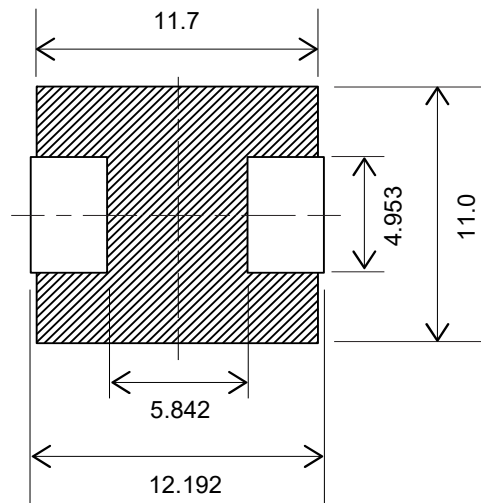

※Don't wire on the pattern on shaded portion the PWB.

Unit : mm

■ As for soldering conditions and safety precautions (Power choke coils (Automotive grade)), please see data files

Packaging methods (Taping)

- Embossed carrier tape dimensions in mm (not to scale)

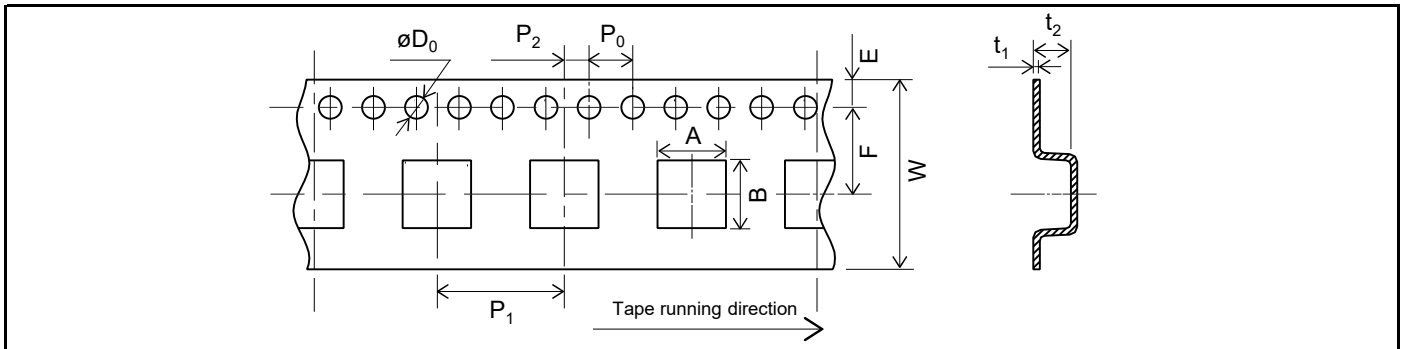

Series	A	B	W	E	F	P ₁	P ₂	P ₀	øD ₀	t ₁	t ₂
PCC-M0530M-LP	5.6	6.1	12	1.75	5.5	8	2	4	1.5	0.3	3.3
PCC-M0630M-LP	6.5	7.1	16	1.75	7.5	8	2	4	1.5	0.3	3.3
PCC-M0840M-LP	8.63	9.1	16	1.75	7.5	12	2	4	1.5	0.4	6.0
PCC-M1040M-LP	10.65	11.75	24	1.75	11.5	16	2	4	1.5	0.5	6.35

Unit : mm

- Taping reel dimensions in mm (not to scale)

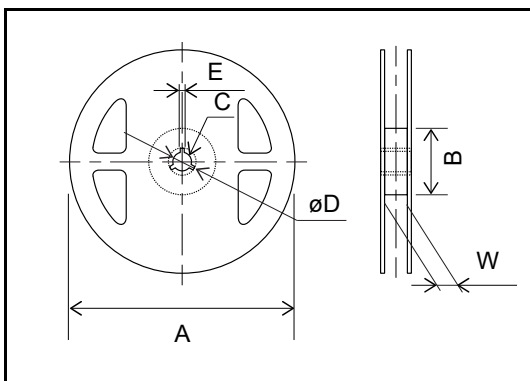

Series	A	B	C	øD	E	W
PCC-M0530M-LP	330	(100)	13	21	2	13.5
PCC-M0630M-LP						17.5
PCC-M0840M-LP						25.5
PCC-M1040M-LP						

Unit : mm

Parts mounting (Taping)

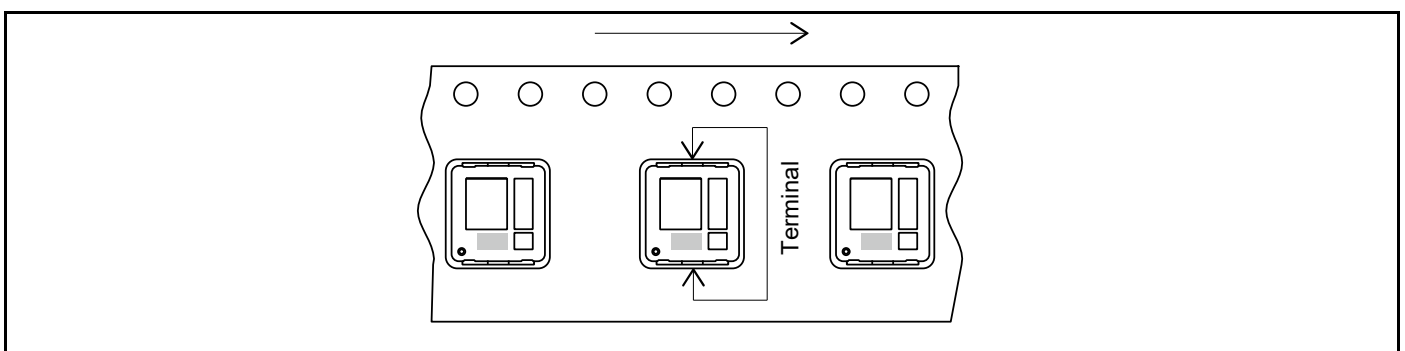

Standard packing quantity / Reel

Series	Part No.	Minimum quantity / Packing unit	Quantity per reel
PCC-M0530M-LP	ETQP3M□□□KVP	4,000 pcs / box (2 reel)	2,000 pcs
PCC-M0630M-LP	ETQP3M□□□KVN		
PCC-M0840M-LP	ETQP4M□□□KVK	1,000 pcs / box (2 reel)	500 pcs
PCC-M1040M-LP	ETQP4M□□□KVC		

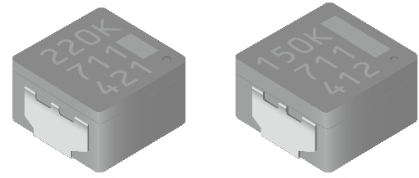

Power Inductors

Power Choke Coil (Automotive Grade)

PCC-M0648M-LE series

PCC-M0748M-LE series

High heat resistance and high reliability using metal composite core (MC)

Industrial property : Patents 3 (Registered 2 / Pending 1)

Features

- Low loss (Low DC resistance)
- High heat resistance : Operation up to 150 °C including self-heating. (180 °C short time*)
* Please contact for possible to use over 150 °C condition. Temperature up to 180 °C may possibly be used.
- SMD type
- High-reliability : High vibration resistance as result of newly developed integral construction ; under severe reliability conditions of automotive and other strenuous applications
- High bias current : Excellent inductance stability using ferrous alloy magnetic material
- Temp. stability : Excellent inductance stability over broad temp. range
- Low audible (buzz) noise : A gapless structure achieved with metal composite core
- High efficiency : Low DC resistance of winding and low eddy-current loss of the core
- Shielded construction
- AEC-Q200 compliant
- RoHS compliant

Recommended applications

- Noise filter for various drive circuitry requiring high temp. operation and peak current handling capability
- Boost-Converter, Buck-Converter DC/DC

Standard packing quantity (Minimum quantity/Packing unit)

- 1,000 pcs/box (2 reel)

Explanation of part numbers

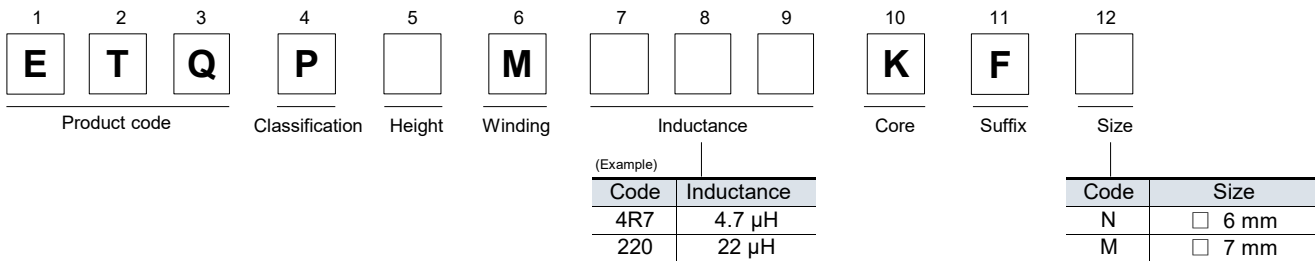

Temperature rating

Operating temperature range		Tc : -40 °C to +150 °C (Including self-temperature rise)
Storage condition	After PWB mounting	
	Before PWB mounting	Ta : -5 °C to +35 °C 85%RH max.

1. PCC-M0648M-LE series (ETQP4M□□□KFN)

Standard parts

Part No.	Inductance ^{*1}		DCR (at 20 °C) (mΩ)		Rated current (A) Typ.		Vibration resistance (G)	MSL	Series [Size L×W×H] (mm)
	L0 (μH)	Tolerance (%)	Typ. (max.)	Tolerance (%)	$\Delta T = 40 \text{ K}^{*2}$ () ^{*3}	$\Delta L =$ -30 % ^{*4}	*5	*6	
ETQP4M3R3KFN	3.3	±20	13.1 (14.41)	±10	9.2 (7.2)	12.2	4.4	1	PCC-M0648M-LE [6.0×6.4×4.8]
ETQP4M4R7KFN	4.7		20.7 (22.77)		7.3 (5.7)	10.2			
ETQP4M6R8KFN	6.8		32.1 (35.31)		5.9 (4.6)	9.9			
ETQP4M100KFN	10.0		40.4 (44.44)		5.2 (4.1)	9.1			
ETQP4M150KFN	15.0		63.8 (70.18)		4.2 (3.3)	6.9			
ETQP4M220KFN	22.0		113.0 (124.3)		3.1 (2.4)	4.1			

*1: Measured at 100 kHz

*2: The proved current value for making the overall temperature rise of 40K, when mounted on a multi-layer board with high-heat dissipation (heat dissipation constant 6.4 x 6.0 x 4.8 mm : approx. 36 K/W).

*3: The proved current value for making the overall temperature rise of 40K, when mounted on a 4-layer circuit board of FR4 t=1.6 mm and DC current is applied.

*4: Saturation rated current : DC current which causes L(0) drop -30 %.

*5: Vibration resistance conditions : Amplitude: 5 mm or less, sweep speed: 1 oct / min, frequency 5-2000 Hz, 3 directions/2 hours each, total 6 hours

*6: The solderability is guaranteed for 1 year only. The product out of expiration date shall not be used.

◆ Within a suitable application, the part's temperature depends on circuit design and certain heat dissipation conditions. This should be double checked in a worst case operation mode. In normal case, the max.standard operating temperature of +150°C should not be exceeded. Please contact for possible to use over 150 °C condition. Temperature up to 180 °C may possibly be used.

Performance characteristics (Reference①)

● Inductance vs DC Current

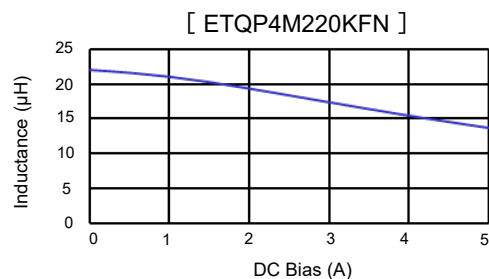
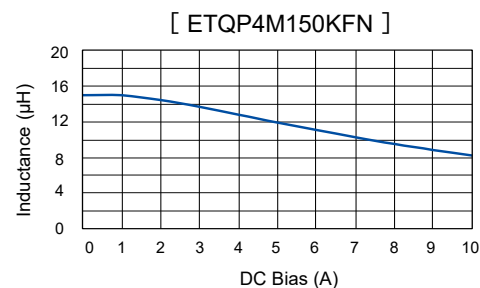
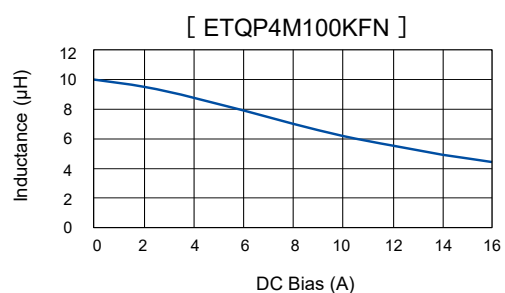
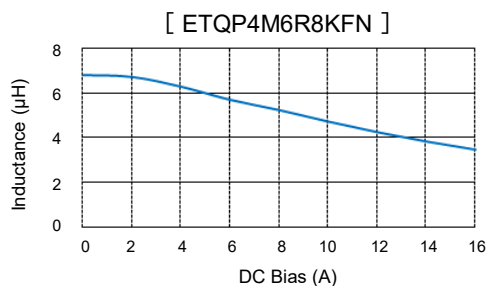
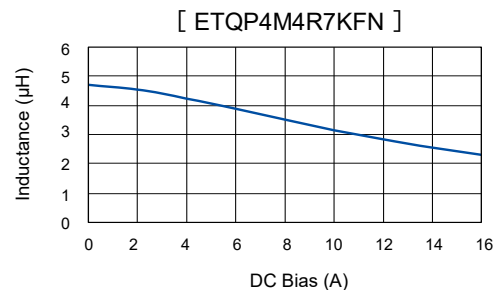
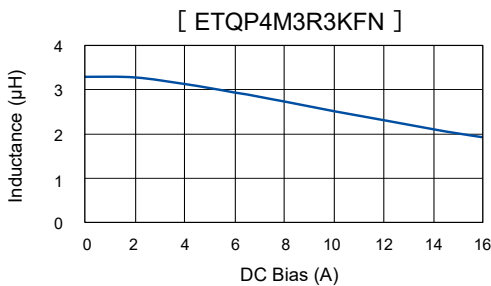

Performance characteristics (Reference②)

● Case Temperature vs DC Current

- PWB condition A : Four-layer PWB (1.6 mm FR4).^{*3}
- - - PWB condition B : Multilayer PWB with high heat dissipation performance.^{*2}

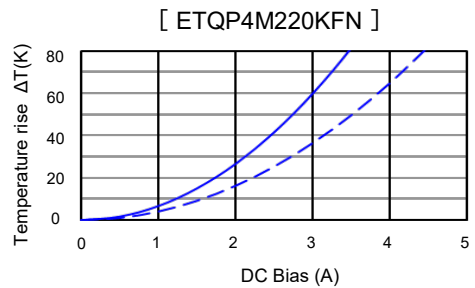
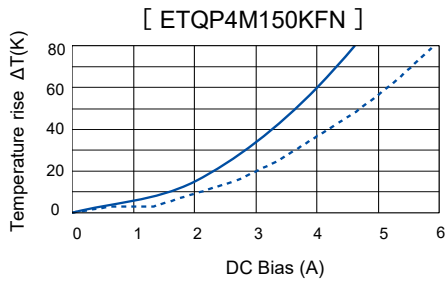
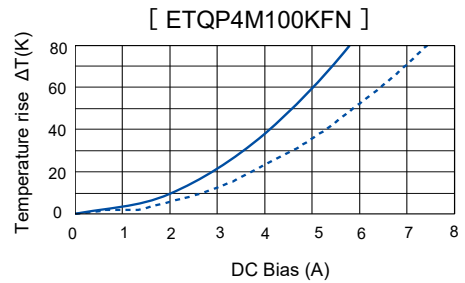
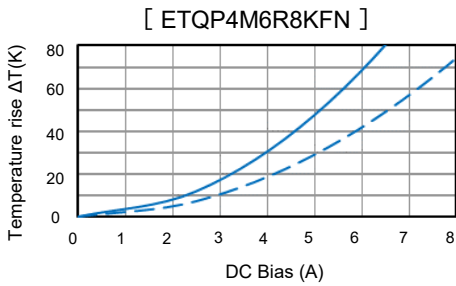
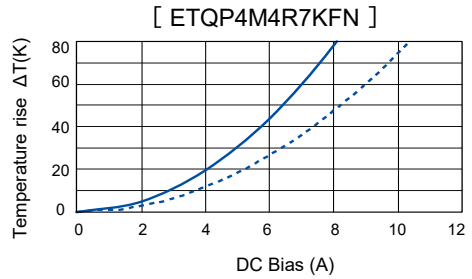
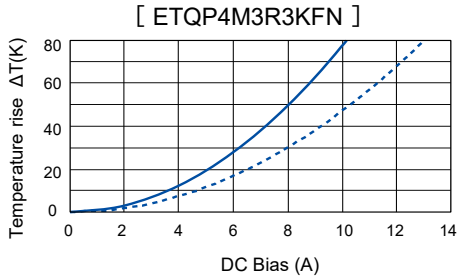

2. PCC-M0748M-LE series (ETQP4M□□□KFM)

Standard parts

Part No.	Inductance *1		DCR (at 20 °C) (mΩ)		Rated current (A) Typ.		Vibration resistance (G)	MSL	Series [Size L×W×H] (mm)
	L0 (μH)	Tolerance (%)	Typ. (max.)	Tolerance (%)	$\Delta T = 40 \text{ K}^{*2}$ () ^{*3}	$\Delta L =$ -30 % ^{*4}	*5	*6	
ETQP4M4R7KFM	4.7	±20	16.8 (18.48)	±10	8.8 (6.5)	10.6	4.4	1	PCC-M0748M-LE [7.0×7.4×4.8]
ETQP4M100KFM	10.0		36.0 (39.60)		6.0 (4.5)	9.5			
ETQP4M150KFM	15.0		60.7 (66.77)		4.6 (3.4)	7.2			
ETQP4M220KFM	22.0		84.1 (92.51)		3.9 (2.9)	5.2			
ETQP4M330KFM	33.0		115.0 (126.5)		3.4 (2.5)	4.2			
ETQP4M470KFM	47.0		148.6 (163.46)		2.9 (2.2)	3.7			

*1: Measured at 100 kHz

*2: The proved current value for making the overall temperature rise of 40K, when mounted on a multi-layer board with high-heat dissipation (heat dissipation constant 7.4 x 7.0 x 4.8 mm : approx. 31 K/W).

*3: The proved current value for making the overall temperature rise of 40K, when mounted on a 4-layer circuit board of FR4 t=1.6 mm and DC current is applied.

*4: Saturation rated current : DC current which causes L(0) drop -30 %.

*5: Vibration resistance conditions : Amplitude: 5 mm or less, sweep speed: 1 oct / min, frequency 5-2000 Hz, 3 directions/2 hours each, total 6 hours

*6: The solderability is guaranteed for 1 year only. The product out of expiration date shall not be used.

◆ Within a suitable application, the part's temperature depends on circuit design and certain heat dissipation conditions. This should be double checked in a worst case operation mode. In normal case, the max.standard operating temperature of +150°C should not be exceeded. Please contact for possible to use over 150 °C condition. Temperature up to 180 °C may possibly be used.

Performance characteristics (Reference①)

● Inductance vs DC Current

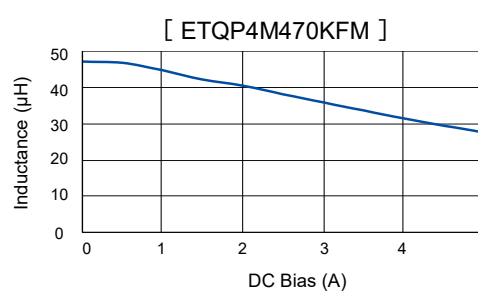
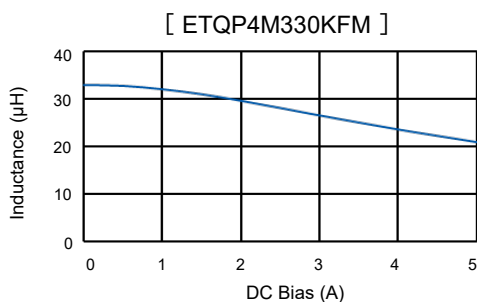
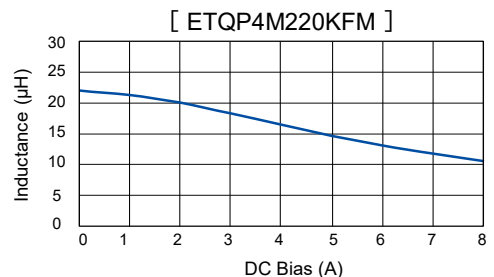
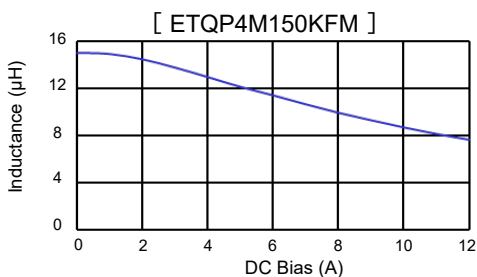
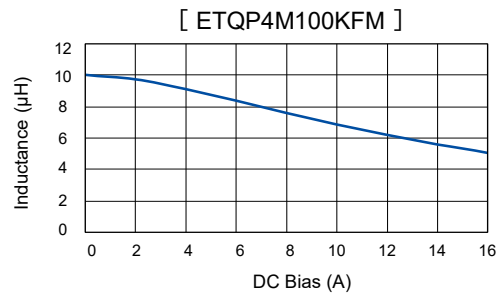
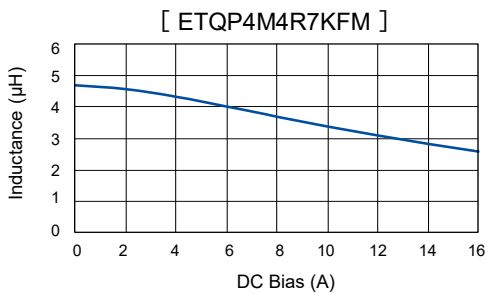

Performance characteristics (Reference②)

● Case Temperature vs DC Current

- PWB condition A : Four-layer PWB (1.6 mm FR4).^{*3}
- - - PWB condition B : Multilayer PWB with high heat dissipation performance.^{*2}

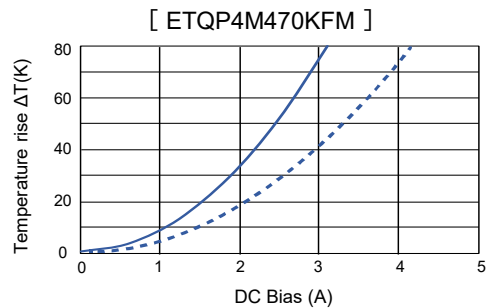
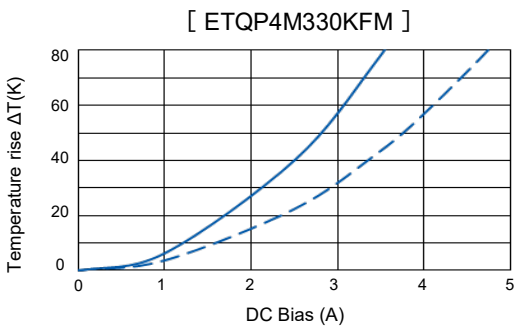
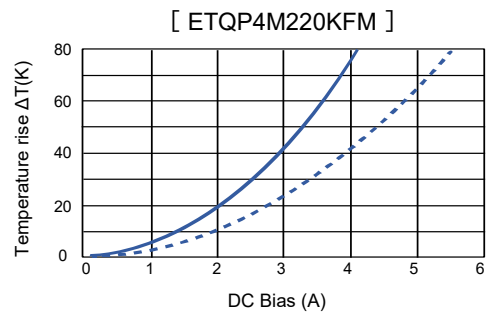
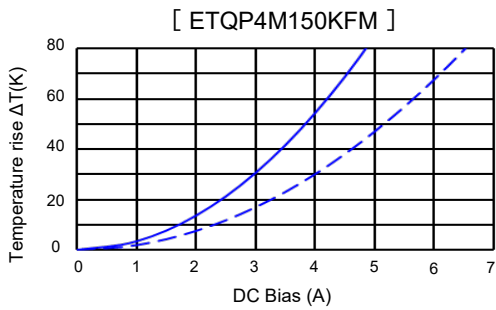
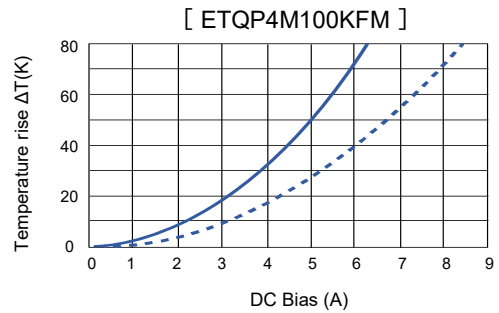
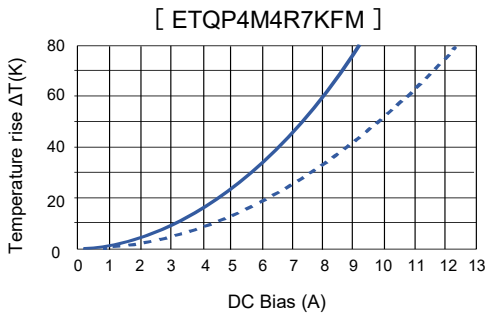

Dimensions in mm (not to scale)

Dimensional tolerance unless noted : ± 0.5

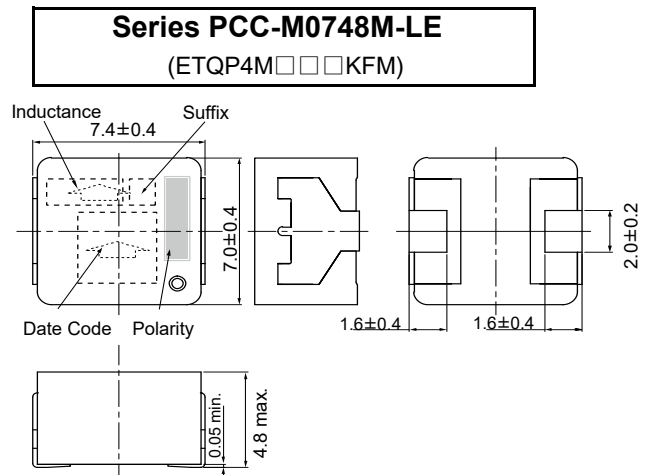
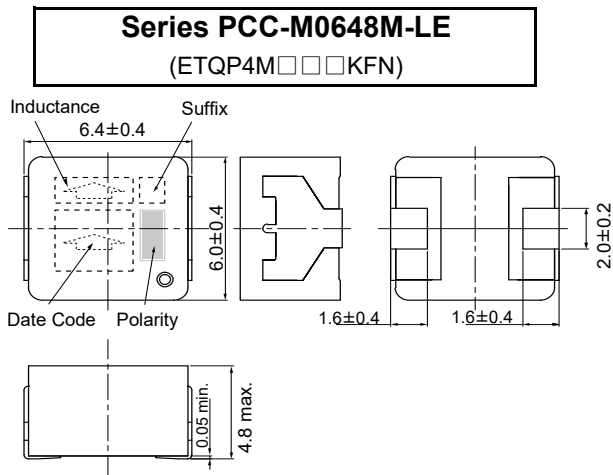

Unit : mm

Recommended land pattern in mm (not to scale)

Dimensional tolerance unless noted : ± 0.5

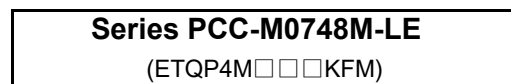
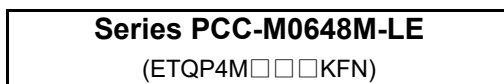

※Don't wire on the pattern on shaded portion the PWB.

Unit : mm

- As for soldering conditions and safety precautions (Power choke coils (Automotive grade)), please see data files

Packaging methods (Taping)

- Embossed Carrier Tape Dimensions in mm (not to scale)

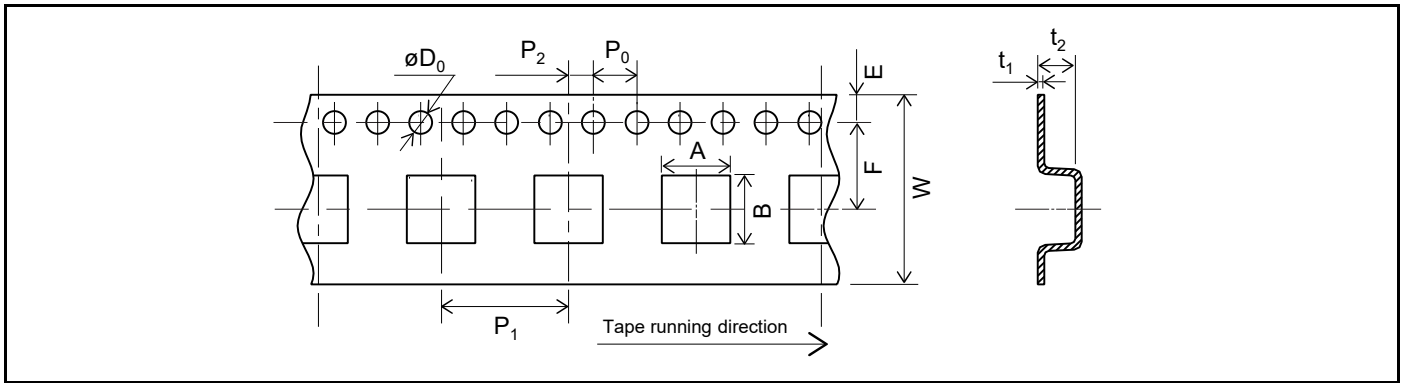

Series	A	B	W	E	F	P ₁	P ₂	P ₀	øD ₀	t ₁	t ₂
PCC-M0648M-LE	6.6	7.1	16	1.75	7.5	12	2	4	1.5	0.4	5.0
PCC-M0748M-LE	7.6	8.1	16	1.75	7.5	12	2	4	1.5	0.4	6.0

Unit : mm

- Taping Reel Dimensions in mm (not to scale)

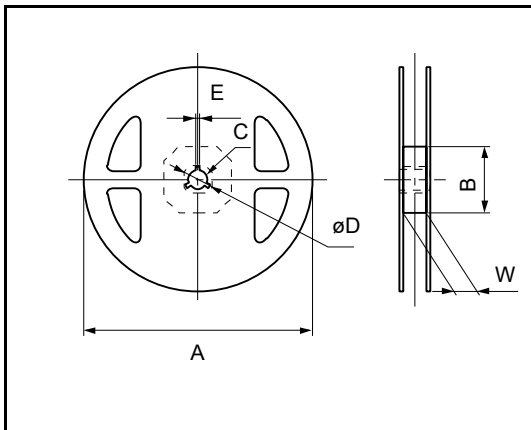

Series	A	B	C	øD	E	W
PCC-M0648M-LE	330	(100)	13	21	2	17.5
PCC-M0748M-LE						

Unit : mm

Parts mounting (Taping)

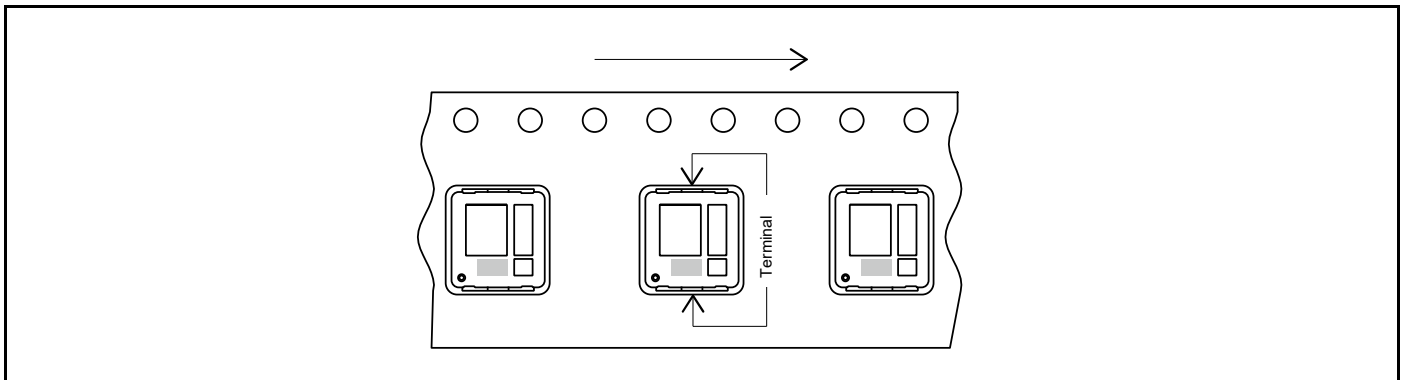

Standard packing quantity / Reel

Series	Part No.	Minimum quantity / Packing unit	Quantity per reel
PCC-M0648M-LE	ETQP4M□□□KFN	1,000 pcs / box (2 reel)	500 pcs
PCC-M0748M-LE	ETQP4M□□□KFM		

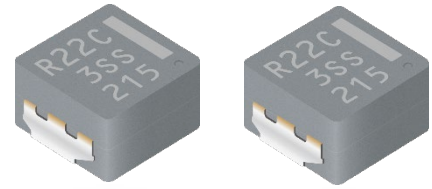

Power Inductors

Power Choke Coil (Automotive Grade)

PCC-M0750M-LL series

High heat resistance and high reliability using metal composite core (MC)

Features

- High efficiency : Low DC resistance of winding and low eddy-current loss of the core
- High heat resistance : Operation up to 155 °C including self-heating. (180 °C short time*)
* Please contact for possible to use over 155 °C condition. Temperature up to 180 °C may possibly be used.
- Low profile : 5 mm max. height
- SMD type
- High-reliability : High vibration resistance as result of newly developed integral construction ;
under severe reliability conditions of automotive and other strenuous applications
- High bias current : Excellent inductance stability using ferrous alloy magnetic material
- Temp. stability : Excellent inductance stability over broad temp. range
- Low audible (buzz) noise : A gapless structure achieved with metal composite core
- Shielded construction
- AEC-Q200 compliant
- RoHS compliant

Recommended applications

- Boost-Converter, Buck-Converter DC / DC

Standard packing quantity (Minimum quantity/Packing unit)

- 1,000 pcs / box (2 reel)

Explanation of part numbers

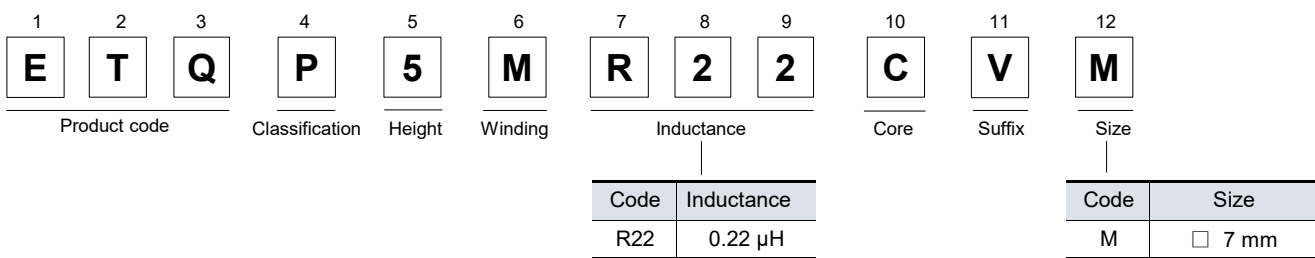

Temperature rating

Operating temperature range		Tc : -55 °C to +155 °C (Including self-temperature rise)
Storage condition	After PWB mounting	Ta : -5 °C to +35 °C 85%RH max.
	Before PWB mounting	

PCC-M0750M-LL series (ETQP5M□□□CVM)

Standard parts

Part No.	Inductance ^{*1}		DCR (at 20 °C) (mΩ)		Rated current (A) Typ.		Vibration resistance (G)	MSL	Series [Size L×W×H] (mm)
	L0 (μH)	Tolerance (%)	Typ. (max.)	Tolerance (%)	$\Delta T = 40 \text{ K}^{*2}$ () ^{*3}	$\Delta L =$ -30 % ^{*4}			
▲ETQP5MR22CVM	0.22	±20	0.71 (0.78)	±10	44.0 (32.0)	63.7	*5	*6	PCC-M0750M-LL [7.0×7.9×5.0]

*1: Measured at 100 kHz

▲ Development product

*2: The proved current value for making the overall temperature rise of 40K, when mounted on a multi-layer board with high-heat dissipation (heat dissipation constant : approx. 29 K/W).

*3: The proved current value for making the overall temperature rise of 40K, when mounted on a 4-layer circuit board of FR4 t=1.6 mm and DC current is applied.

*4: Saturation rated current : DC current which causes L(0) drop -30 %.

*5: Vibration resistance conditions : Amplitude: 5 mm or less, sweep speed: 1 oct / min, frequency 5-2000 Hz, 3 directions/4 hours each, total 12 hours

*6: The solderability is guaranteed for 1 year only. The product out of expiration date shall not be used.

◆ Within a suitable application, the part's temperature depends on circuit design and certain heat dissipation conditions. This should be double checked in a worst case operation mode. In normal case, the max.standard operating temperature of +155 °C should not be exceeded. For higher operating temperature conditions, please contact Panasonic representative in your area.

Performance characteristics (Reference①)

● Inductance vs DC Current

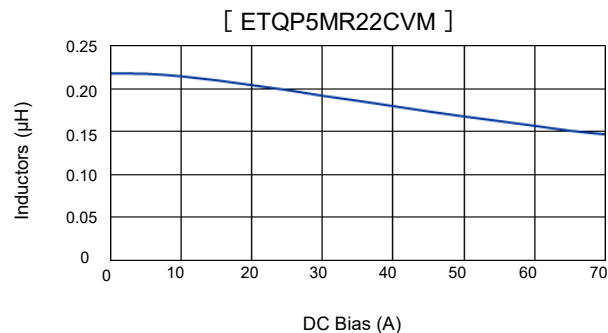

Performance characteristics (Reference②)

● Case Temperature vs DC Current

- PWB condition A : Four-layer PWB (1.6 mm FR4).^{*3}
- - - PWB condition B : Multilayer PWB with high heat dissipation performance.^{*2}

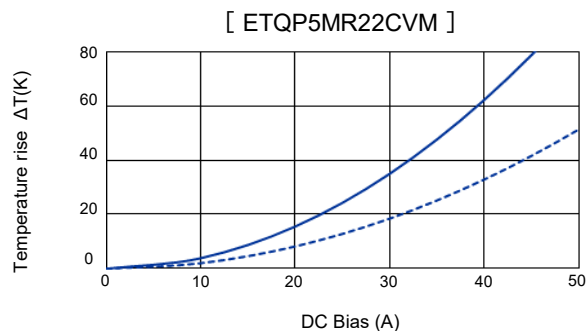

Dimensions in mm (not to scale)

Dimensional tolerance unless noted : ± 0.5

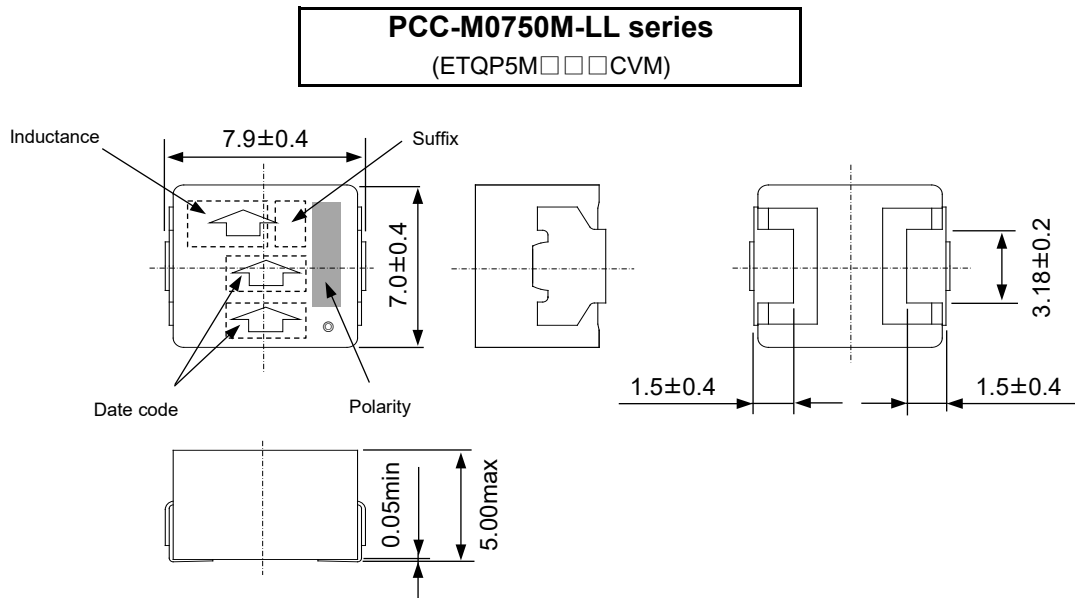

Unit : mm

Recommended land pattern in mm (not to scale)

Dimensional tolerance unless noted : ± 0.5

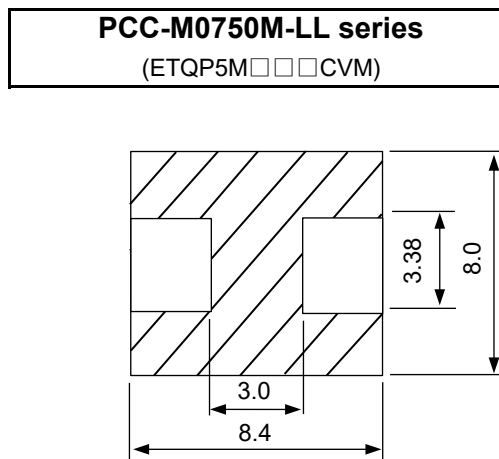

※Don't wire on the pattern on shaded portion the PWB.

Unit : mm

- As for soldering conditions and safety precautions (Power choke coils (Automotive grade)), please see data files

Packaging methods (Taping)

- Embossed carrier tape dimensions in mm (not to scale)

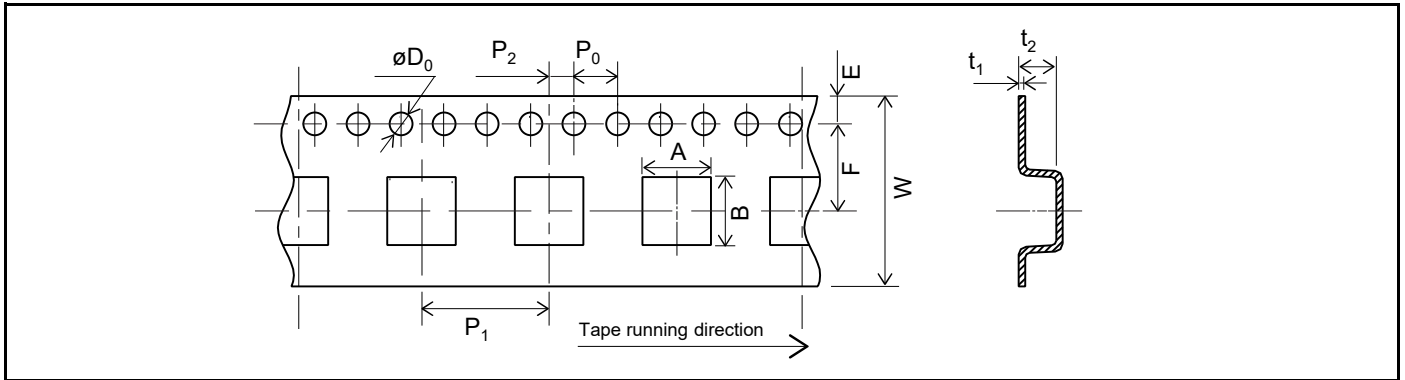

Series	A	B	W	E	F	P ₁	P ₂	P ₀	øD ₀	t ₁	t ₂
PCC-M0750M-LL	7.7	8.3	16	1.75	7.5	12	2	4	1.5	0.4	6.0

Unit : mm

- Taping reel dimensions in mm (not to scale)

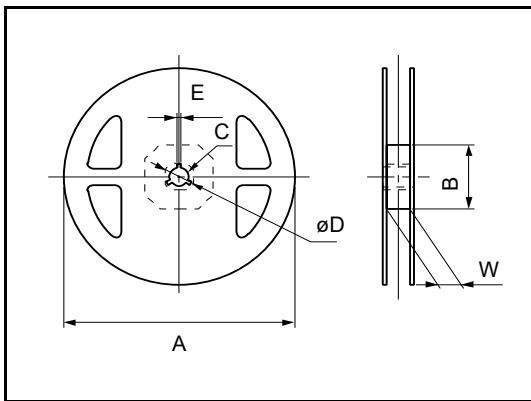

Series	A	B	C	øD	E	W
PCC-M0750M-LL	330	(100)	13	21	2	17.5

Unit : mm

Parts mounting (Taping)

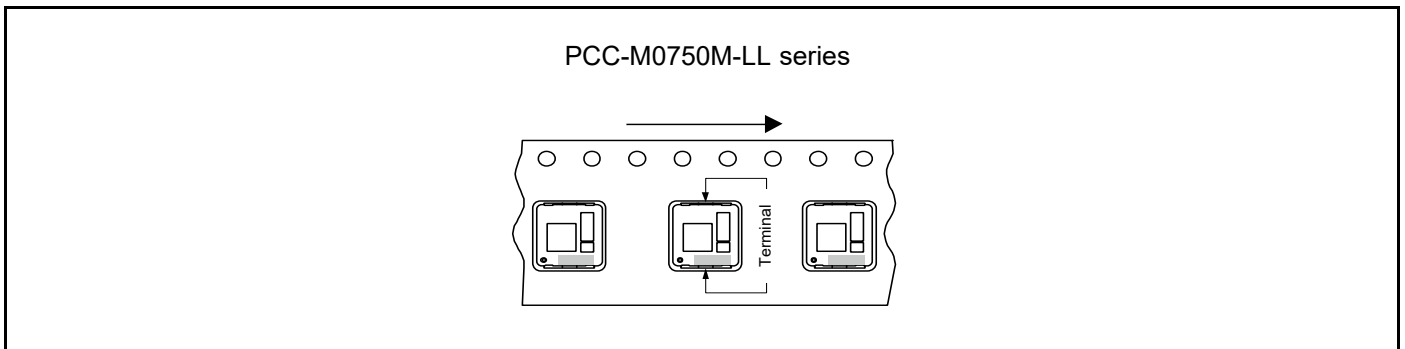

Standard packing quantity / Reel

Series	Part No.	Minimum quantity / Packing unit	Quantity per reel
PCC-M0750M-LL	ETQP5M□□□CVM	1,000 pcs / box (2 reel)	500 pcs

Power Inductors

Power Choke Coil (Automotive Grade)

PCC-M0530M-H series

PCC-M0630M-H series

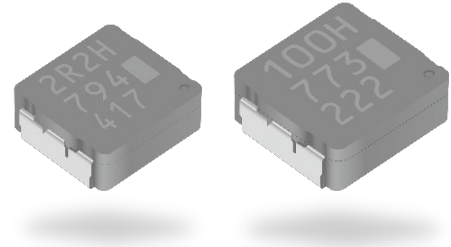

High heat resistance and high reliability using metal composite core (MC)

Features

- Reduce core loss in high frequency band (More than 2 MHz)
- High heat resistance : Operation up to 150 °C including self-heating
- Low profile : 3 mm max. height
- SMD type
- High-reliability : High vibration resistance as result of newly developed integral construction ; under severe reliability conditions of automotive and other strenuous applications
- High bias current : Excellent inductance stability using ferrous alloy magnetic material
- Temp. stability : Excellent inductance stability over broad temp. range
- Low audible (buzz) noise : A gapless structure achieved with metal composite core
- High efficiency : Low DC resistance of winding and low eddy-current loss of the core
- Shielded construction
- AEC-Q200 compliant
- RoHS compliant

Recommended applications

- Noise filter for various drive circuitry requiring high temp. operation and peak current handling capability
- Boost-Converter, Buck-Converter DC/DC

Standard packing quantity (Minimum quantity/Packing unit)

- 2,000 pcs/box (2 reel)

Explanation of part numbers

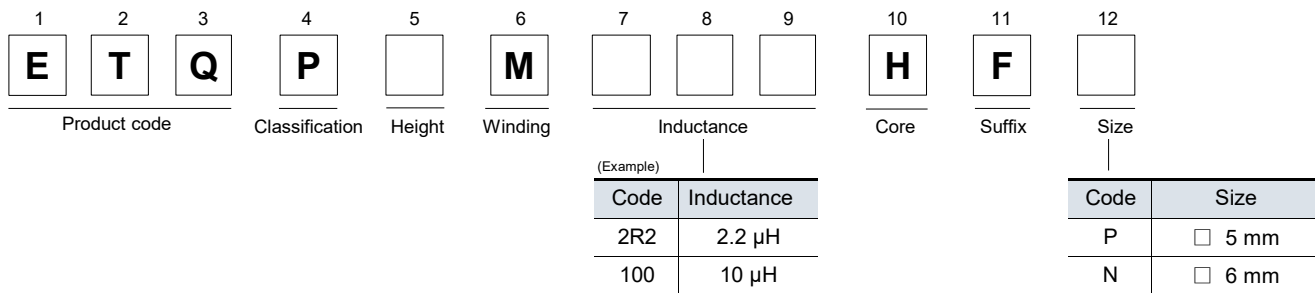

Temperature rating

Operating temperature range		Tc : -40 °C to +150 °C (Including self-temperature rise)
Storage condition	After PWB mounting	
	Before PWB mounting	Ta : -5 °C to +35 °C 85%RH max.

PCC-M0530M-H / PCC-M0630M-H series (ETQP3M□□□HFP/ETQP3M□□□HFN)

Standard parts

Part No.	Inductance *1		DCR (at 20 °C) (mΩ)		Rated current (A) Typ.		MSL *5	Series [Size L×W×H] (mm)
	L0 (μH)	Tolerance (%)	Typ. (max.)	Tolerance (%)	$\Delta T = 40 \text{ K}^2$ () ^{*3}	$\Delta L = -30 \%$ *4		
ETQP3M2R2HFP	2.2	±20	19.5 (21.45)	±20	6.3 (5.2)	9.0	1	PCC-M0530M-H [5.0×5.5×3.0]
ETQP3M100HFN	10.0		68.0 (74.8)		3.7 (3.0)	5.5	1	PCC-M0630M-H
ETQP3M220HFN	22.0		144.0 (158.4)		2.5 (2.1)	4.0	1	[6.0×6.5×3.0]

*1: Measured at 100 kHz

*2: The proved current value for making the overall temperature rise of 40K, when mounted on a multi-layer board with high-heat dissipation (heat dissipation constant : approx. 20 K/W).

*3: The proved current value for making the overall temperature rise of 40K, when mounted on a 4-layer circuit board of FR4 t=1.6 mm and DC current is applied.

*4: Saturation rated current : DC current which causes L(0) drop -30 %.

*5: The solderability is guaranteed for 1 year only. The product out of expiration date shall not be used.

◆ Within a suitable application, the part's temperature depends on circuit design and certain heat dissipation conditions. This should be double checked in a worst case operation mode. In normal case, the max.standard operating temperature of +150°C should not be exceeded. For higher operating temperature conditions, please contact Panasonic representative in your area.

Performance characteristics (Reference①)

● Inductance vs DC Current

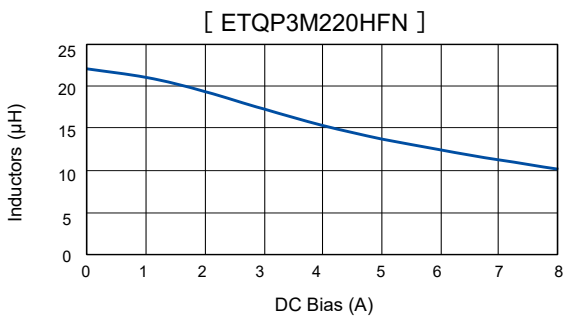
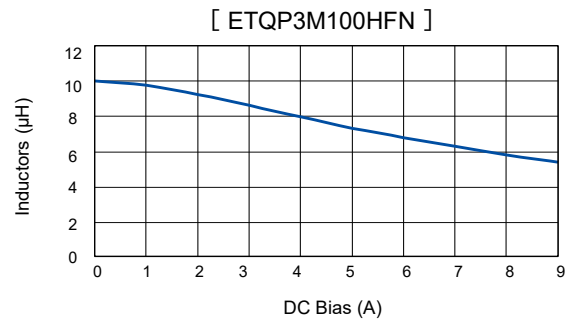
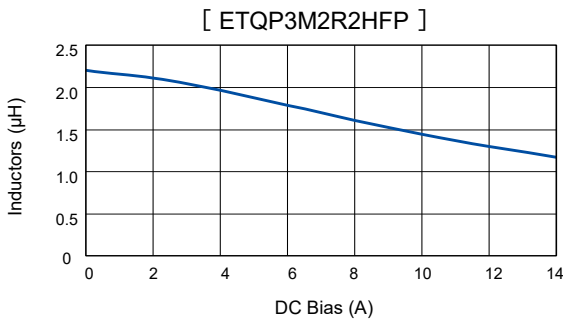

Performance characteristics (Reference②)

● Case Temperature vs DC Current

- PWB condition A : Four-layer PWB (1.6 mm FR4).^{*3}
- - - PWB condition B : Multilayer PWB with high heat dissipation performance.^{*2}

[ETQP3M2R2HFP]

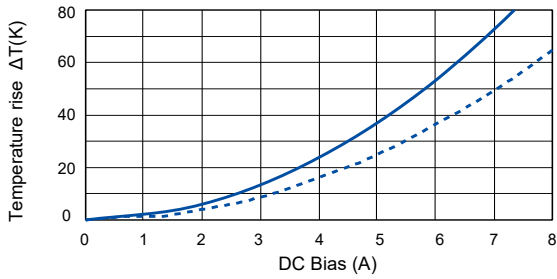

[ETQP3M100HFN]

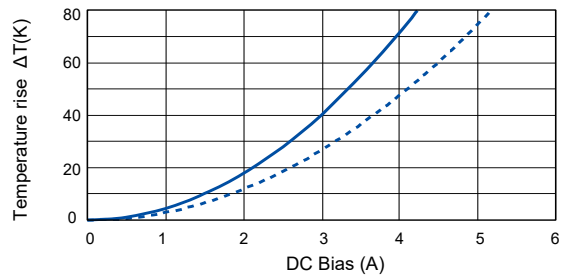

:TQP3M2208/208/208/20HF1

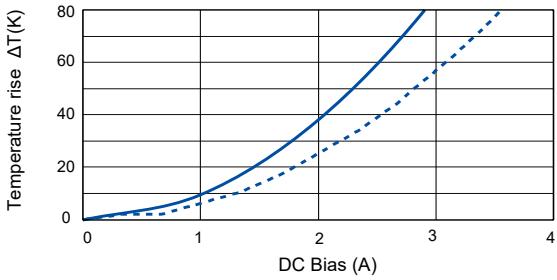

Power Choke Coil (Automotive Grade)

Dimensions in mm (not to scale)

Dimensional tolerance unless noted : ± 0.5

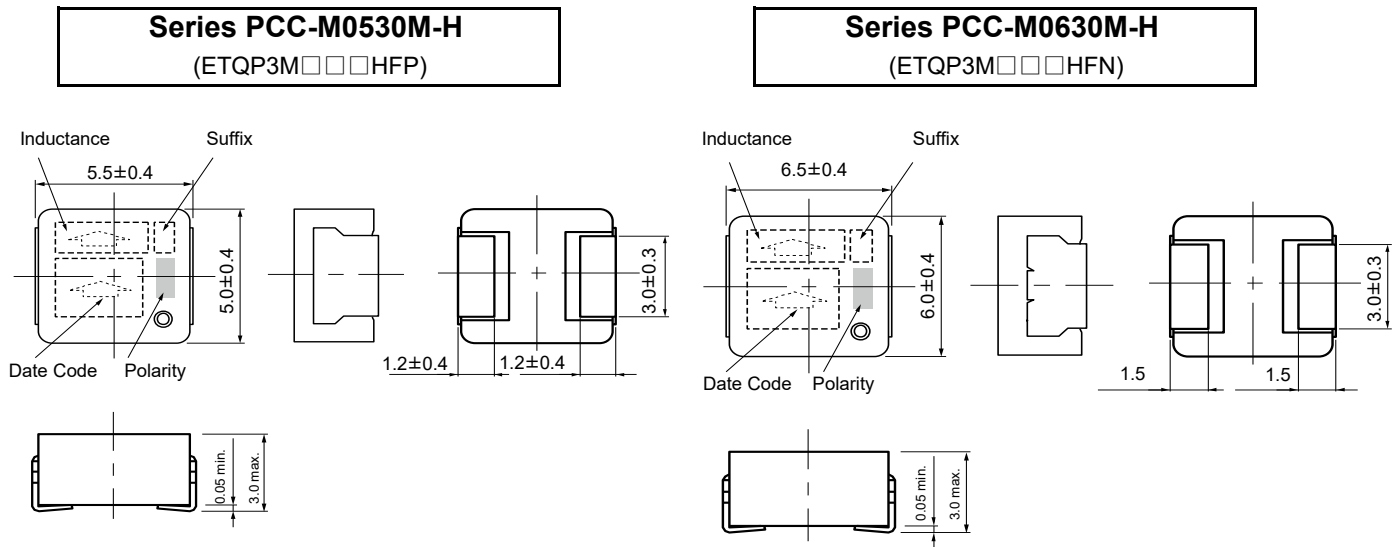

Unit : mm

Recommended land pattern in mm (not to scale)

Dimensional tolerance unless noted : ± 0.5

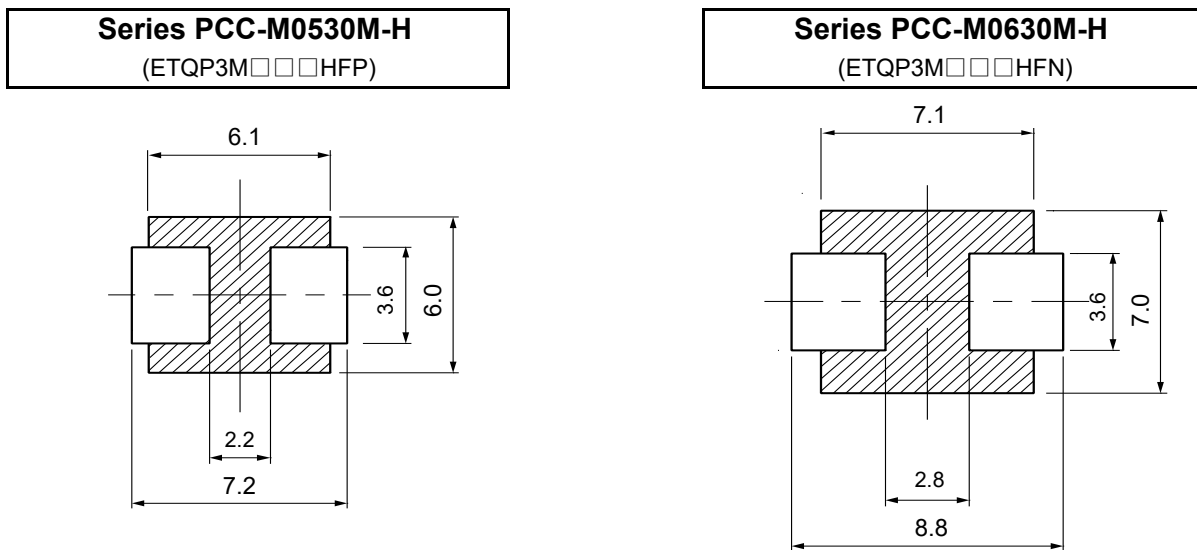

※ Don't wire on the pattern on shaded portion the PWB.

Unit : mm

- As for soldering conditions and safety precautions (Power choke coils (Automotive grade)), please see data files

Packaging methods (Taping)

- Embossed carrier tape dimensions in mm (not to scale)

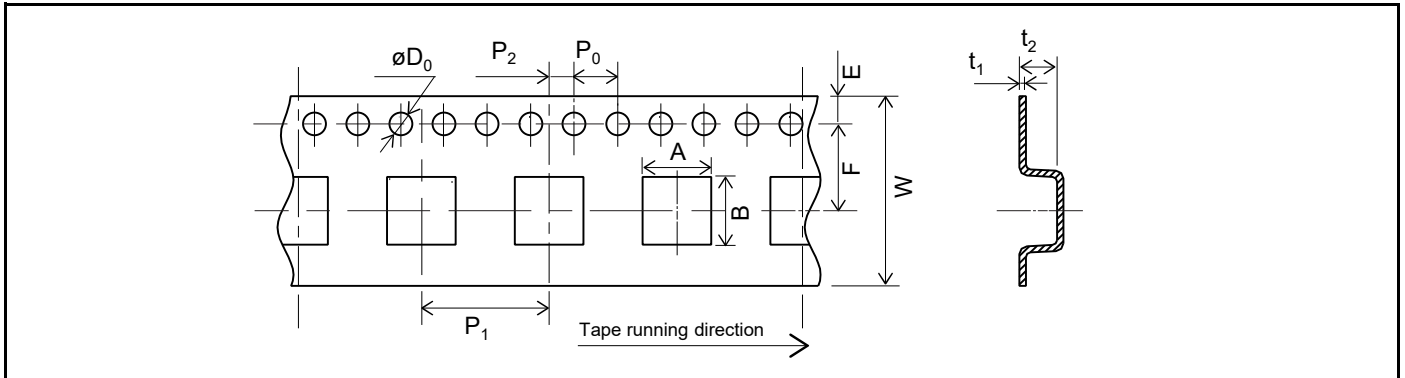

Series	A	B	W	E	F	P ₁	P ₂	P ₀	øD ₀	t ₁	t ₂
PCC-M0530M-H	5.6	6.1	16	1.75	7.5	12	2	4	1.5	0.4	3.3
PCC-M0630M-H	7.1	6.6	16	1.75	7.5	12	2	4	1.5	0.4	3.3

Unit : mm

- Taping reel dimensions in mm (not to scale)

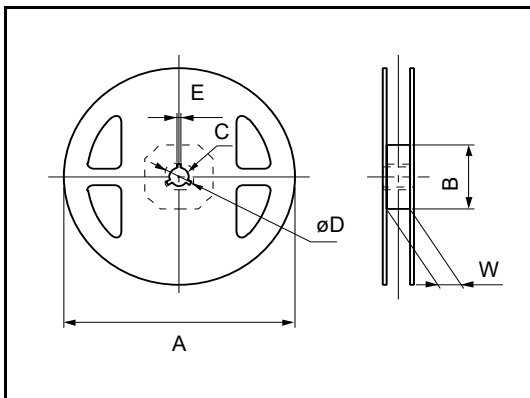

Series	A	B	C	øD	E	W
PCC-M0530M-H	330	(100)	13	21	2	17.5
PCC-M0630M-H						

Unit : mm

Parts mounting (Taping)

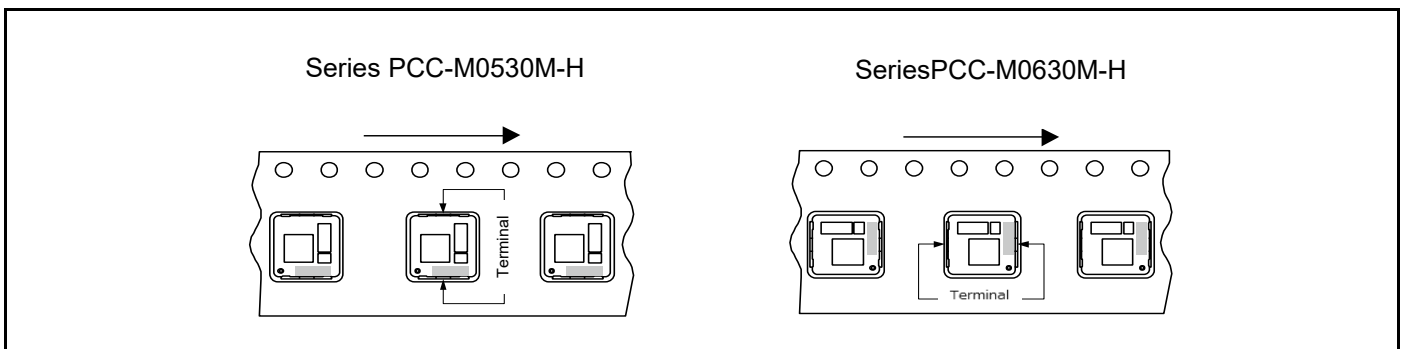

Standard packing quantity / Reel

Series	Part No.	Minimum quantity / Packing unit	Quantity per reel
PCC-M0530M-H	ETQP3M□□□HFP	2,000 pcs / box (2 reel)	1,000 pcs
PCC-M0630M-H	ETQP3M□□□HFN		

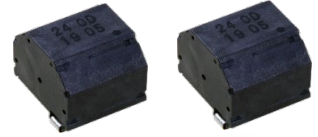

Power Inductors

Power Choke Coil (Automotive Grade)

PCC-D1413H (DUST) series

Realize high heat resistance, low loss and high reliability with dust core (DUST)

Industrial property : patents 5 (Pending)

Features

- High heat resistance : Operation up to 150 °C including self-heating
- SMD and small package : L 14.7×W 13.2×H 13.1 mm
- High-reliability : High vibration resistance as result of newly developed integral construction ; under severe reliability conditions of automotive and other strenuous applications
- High bias current : Excellent inductance stability using ferrous alloy magnetic material
- High Vibration proof : 5 Hz to 2 kHz/30 G
- High efficiency : Achieve by Low loss Dust core and Edgewise coil with rectangular wire
- Shielded construction
- AEC-Q200 compliant
- RoHS compliant

Recommended applications

- Driver circuits of fuel injection systems in automotive, driver circuits of diesel common rail injection, step-up power supplies for motor driver-circuits

Standard packing quantity (Minimum quantity/Packing unit)

- 600 pcs /10 tray

Explanation of part numbers

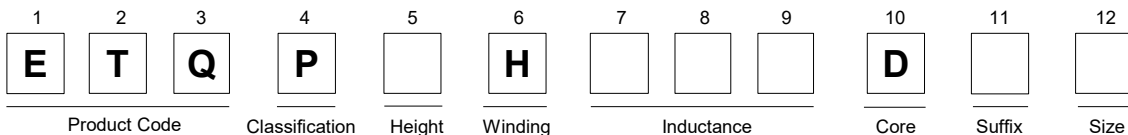

Temperature rating

Operating temperature range		Tc : -40 °C to +150 °C (Including self-temperature rise)
Storage condition	After PWB mounting	
	Before PWB mounting	Ta : -5 °C to +35 °C 85%RH max.

Standard parts

Part No.	Inductance ^{*1}		DCR	ACR	Rated current ^{*3}
	L0 at 0A (μH)	L1 at 10A (μH)	at 20 °C (mΩ)	at 20 kHz (mΩ)	ΔT=40K (A)
ETQPDH240DTV	36.0±30 %	(24.0) ^{*2}	25.8 typ.	50.0 typ.	6.9

*1: Measured at 100 kHz.

*2: Reference Only.

*3: DC current which causes temperature rise of 40K. Parts are soldered by reflow on four-layer PWB(1.6 mm FR4) and measured at room temperature.

◆ Within a suitable application, the part's temperature depends on circuit design and certain heat dissipation conditions. This should be double checked in a worst case operation mode. In normal case, the max.standard operating temperature of +150°C should not be exceeded. For higher operating temperature conditions, please contact Panasonic representative in your area.

Power Choke Coil (Automotive Grade)

Performance characteristics (Reference)

● Inductance vs DC Current

[ETQPDH240DTV]

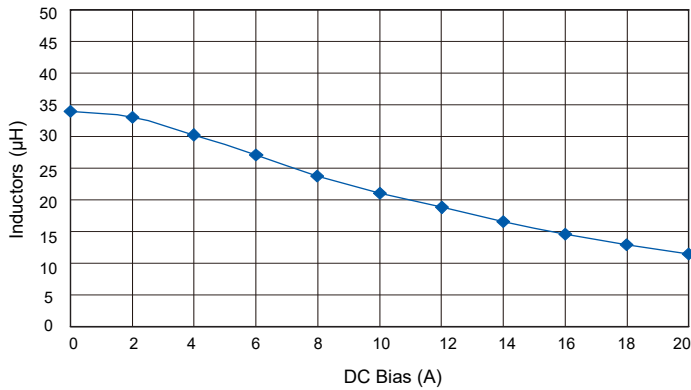

● Case Temperature vs DC Current

[ETQPDH240DTV]

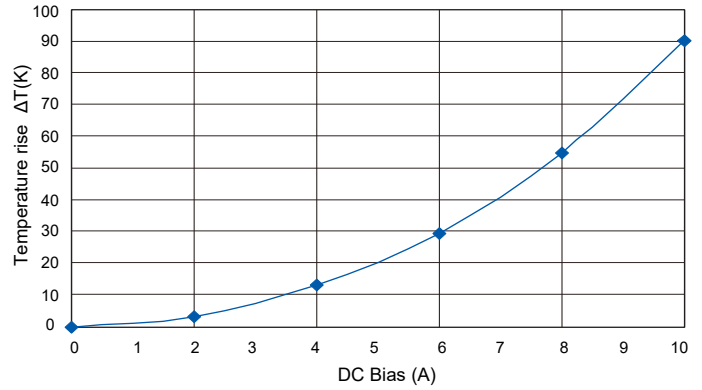

Dimensions in mm (not to scale)

Dimensional tolerance unless noted : ± 0.5

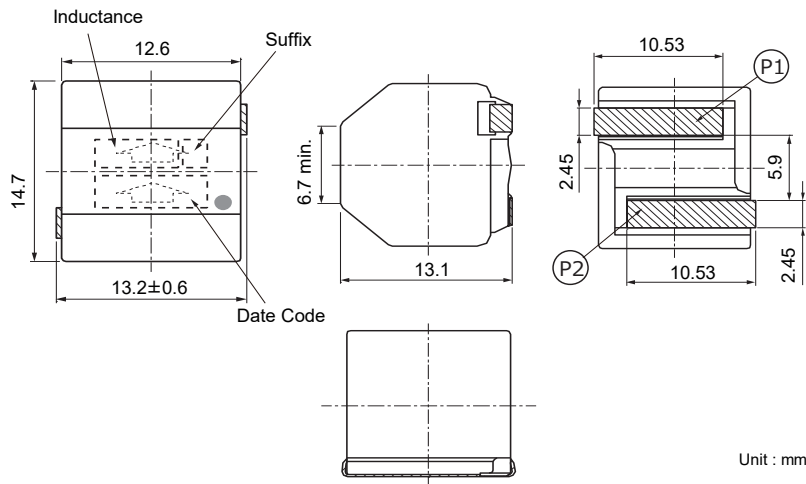

Connection

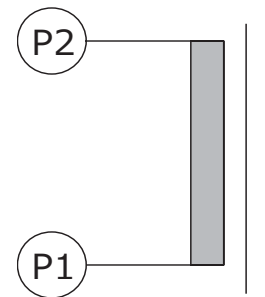

*None polar character

Recommended land pattern in mm (not to scale)

Dimensional tolerance unless noted : ± 0.5

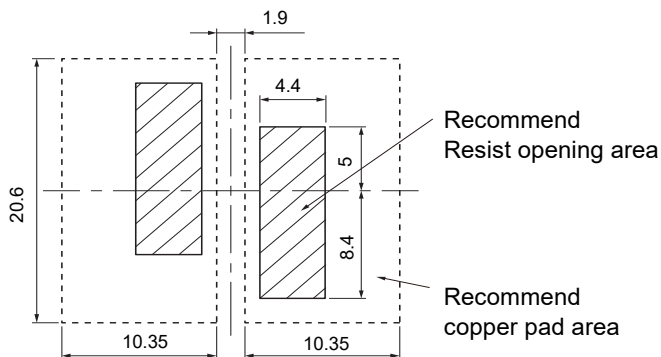

* Due to bigger part, Thermal Capacity is large and may occur PWB temperature differences during reflow process.
Recommended land pattern (Heat absorb) should be designed with reflow mountability.

Unit : mm

■ As for soldering conditions and safety precautions (Power choke coils (Automotive grade)), please see data files

Packaging methods (Tray)

- Blister tray (mm) 60 pcs

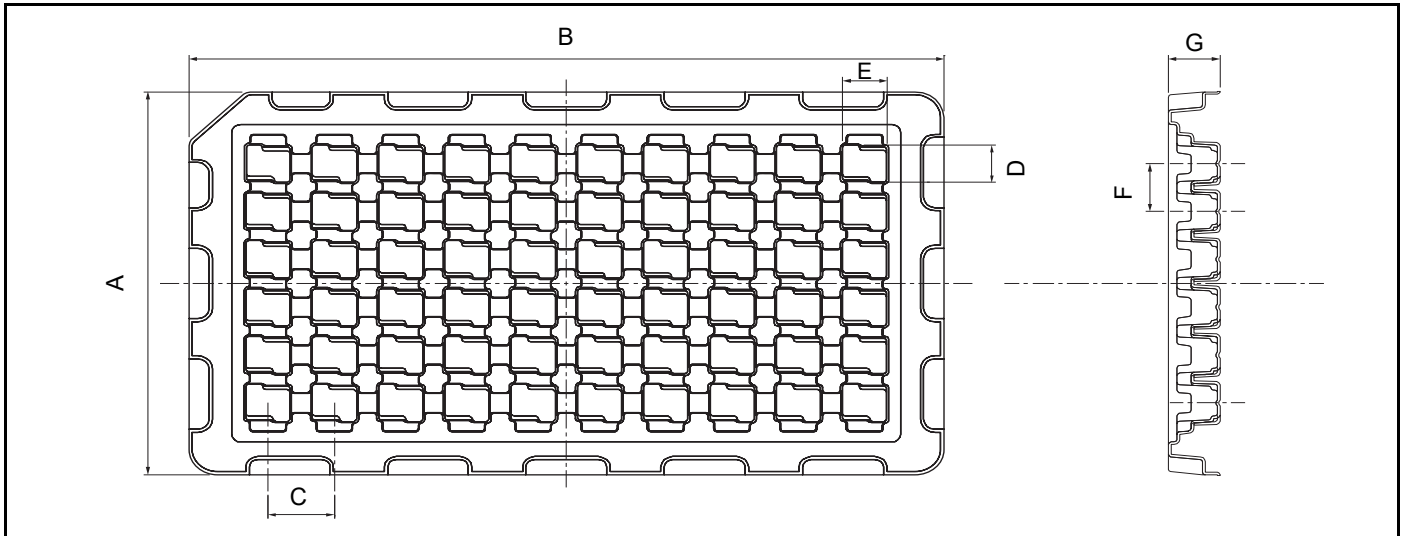

- Blister tray dimension

Part No.	A	B	C	D	E	F	G
ETQPDH240DTV	152	262	23	14.8	15.1	19	18

Unit : mm

Parts mounting (Tray)

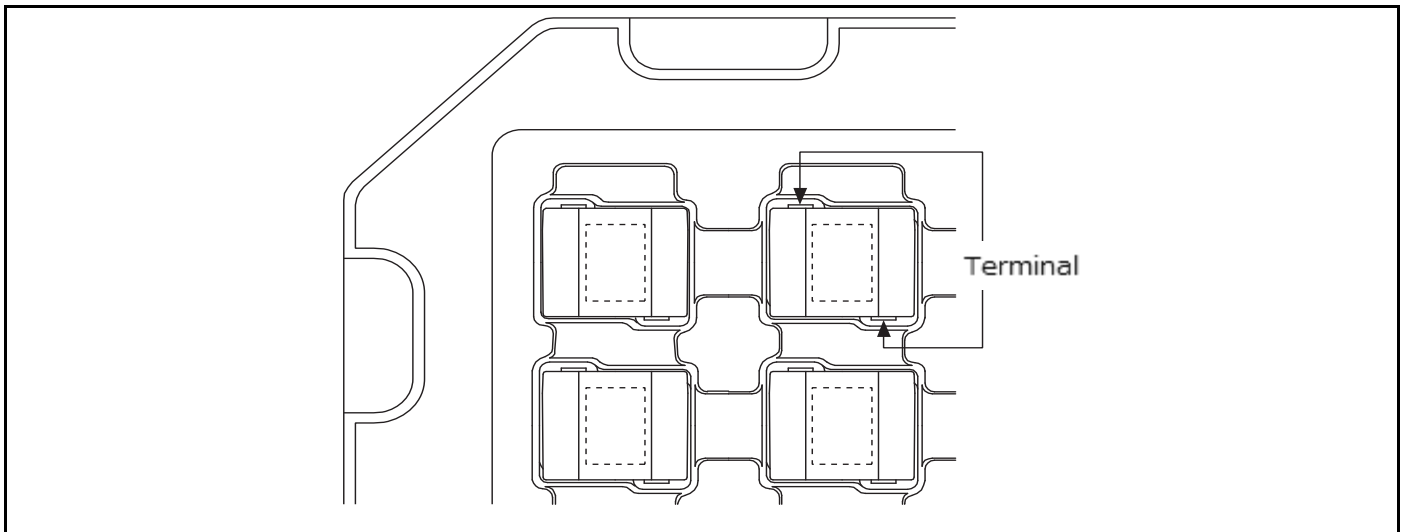

Standard packing quantity / Tray

Part No.	Quantity
ETQPDH240DTV	600 pcs / 10 Tray (60 pcs / 1 Tray)

Reflow soldering conditions

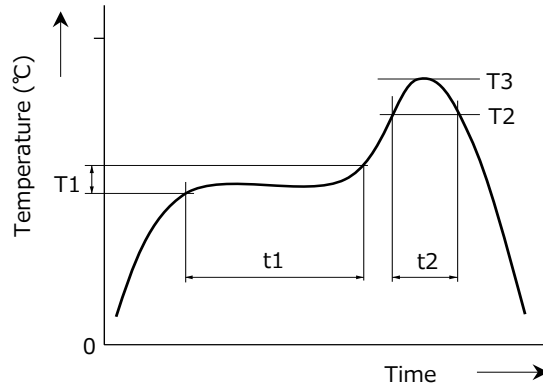

- Pb free solder recommended temperature profile
Power Choke Coils (Automotive Grade)

Series	Preheat		Soldering		Peak temperature		Time of reflow
	T1 [°C]	t1 [s]	T2 [°C]	t2 [s]	T3	T3 limit	
ETQP3M□□□YFP	150 to 170	60 to 120	230°C	30 to 40	250°C, 5 s	260°C, 10 s	2 times max.
ETQP4M□□□YFP							
ETQP3M□□□YFN							
ETQP4M□□□YFN							
ETQP5M□□□YFM							
ETQP5M□□□YGM							
ETQP5M□□□YFK							
ETQP5M□□□YGK							
ETQP5M□□□YFC							
ETQP5M□□□YGC							
ETQP5M□□□YLC							
ETQP6M□□□YLC							
ETQP5M□□□YSK							
ETQP5M□□□YSC							
ETQP8M□□□JFA							
ETQP3M□□□KVP							
ETQP3M□□□KVN							
ETQP4M□□□KVK							
ETQP4M□□□KVC							
ETQP4M□□□KFN							
ETQP4M□□□KFM							
ETQP3M□□□HFP							
ETQP3M□□□HFN							
ETQPDH□□□DTV							

Matters to Be Observed When Using This Product

(Power inductor for consumer use)

Use environments and cleaning conditions

- This product (capacitor) is intended for standard general-purpose use in electronic equipment, and is not designed for use in the specific environments described below. Using the product in such specific environments or service conditions, therefore, may affect the performance of the product.
Please check with us about the performance and reliability of the product first before using the product.
 - (1) A product splashed with water, coffee, etc., is in a wet state.
 - (2) Used in a place where the product is heavily exposed to sea breeze or a corrosive gas, such as Cl₂, H₂S, NH₃, SO₂, or NO_x.
 - (3) Used in an outdoor environment where the product is exposed to direct sunlight, ozone, radiation, UV-rays, etc., or in a dusty place.
- Sealing the product with a resin may damage the copper wire insulation cover of the product. In such a case, consult us first.
- Immersing the product in a solvent, cleaning agent, or coating agent containing toluene or xylene for a long period may result in a significant drop in the performance of the product. In such a case, consult us first.

Response to anomalies and handling conditions

- The inductor, as a single component, does not have a protective function against a problem such as overloading, short circuit, or open failure. Make sure to provide a circuit set with a protection device or circuit that protects the inductor, and confirm that smoke generation/ignition, weakened dielectric strength, lower insulation resistance, etc., do not occur.
- The temperature rise rate of the inductor changes depending on the state in which the inductor is incorporated in the circuit set. Make sure to confirm that the temperature of the inductor is equal to or lower than the temperature corresponding to the specified insulation class (heat-resistant class) when the inductor is incorporated in the circuit set.
- Applying voltage higher than the specified withstand voltage to the inductor at a dielectric strength test leads to the deterioration of the insulation performance of the inductor. Be careful to avoid this.
- Handle the inductor while protecting it from static electricity with proper electrostatic control measures.
(Process/equipment) Applying voltage equal to or higher than 200 V to the inductor may change its characteristics. Keep voltage applied to the inductor lower than 200 V.
- The inductor having received mechanical stress as a result of dropping on the floor, etc., may have formed a crack on its bobbin, etc., and therefore the performance of the inductor may have dropped significantly. Avoid using such an inductor.
- When severe mechanical stress is applied to an inductor, its core may chip or crack.
There are also some cases where the core already has a chipped or cracked part. However, this chip or crack is negligible and has no effect on the quality of the inductor.
- The storage temperature of an inductor ranges from -5 °C to 35 °C, and the working temperature (ambient temperature) of an inductor ranges from -40 °C to 130 °C (which includes the temperature increase).
* The highest working temperature of PCC-F126(N6) series is 100 °C.

Circuit design and circuit board design

- When the inductor is used in a different product set among a series of similar product sets, there are times when the inductor will fail to achieve 100% of its capability because of the difference in service conditions, etc. In such a case, consult us first.
- When there is a possibility that electrostatic noise is applied to circuit components, place an ESD preventing component, such as a capacitor resistant to static electricity, in a preceding stage to the inductor. In such a case, consult us first.

Reference information

Labeling on package

On the inductor package, a product number, the number of components, and the place of origin are indicated. Usually, the place of origin is written in English.

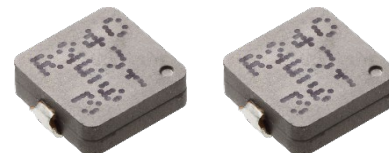

Power Inductors

Power Choke Coil

PCC-M0730L (MC) series

Small mounting size for multi-phase DC/DC converter circuits

Industrial property : Patents 18 (Registered 15 / Pending 3)

Features

- Small type (8.7×7.0×H3.0 mm)
- High power (22 A)
- Low loss (DCR : 1.12 mΩ)
- Tighter DCR tolerance (±7 %)
- Suitable for high frequency circuit (up to 1 MHz)
- Low buzz noise due to its gap-less structure
- Shielded construction
- RoHS compliant

Recommended applications

- Notebook and Desktop PC power supply modules
- Servers, Routers, DC/DC converters for driving CPUs

Standard packing quantity (Minimum quantity/Packing unit)

- 3,000 pcs/box (2 reel)

Explanation of part numbers

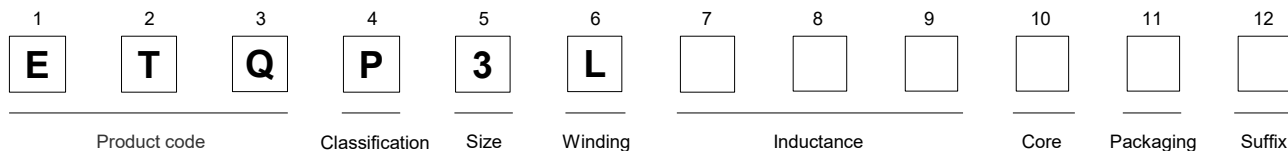

Standard parts

Part No.	Inductance (at 20°C) ^{*1}			Rated current (A) ^{*2}	Rated current (reference) (A) ^{*3}	DC resistance (at 20°C) (mΩ) max.
	L0 at 0A	L1 ^{*4}				
	(μH)	(μH)	Measurement current (A)			
ETQP3LR15CFM	0.15±20 %	(0.12)	29	29	43	0.66±7 %
ETQP3LR24CFM	0.24±20 %	(0.19)	22	22	35	1.12±7 %

*1: Inductance is measured at 1.0 MHz.

*2: Rated current defines actual value of DC current, when temperature rise of coil becomes 40 K. (Method A)

*3: Rated current (reference) defines actual value of DC current, when temperature rise of coil becomes 40 K. (Method B)

*4: Reference only

◆ Method A (PANASONIC's standard measurement conditions), Method B (high heat dissipation measurement) is different from Method A by the measurement methods. In normal application condition, the part's temperature depends on circuit design and heat dissipation condition. This condition shall be verified by the worst operational condition.

Performance characteristics (Reference)

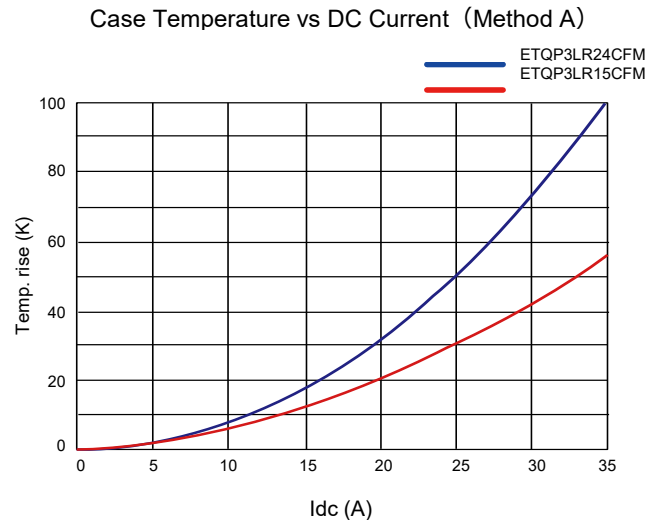
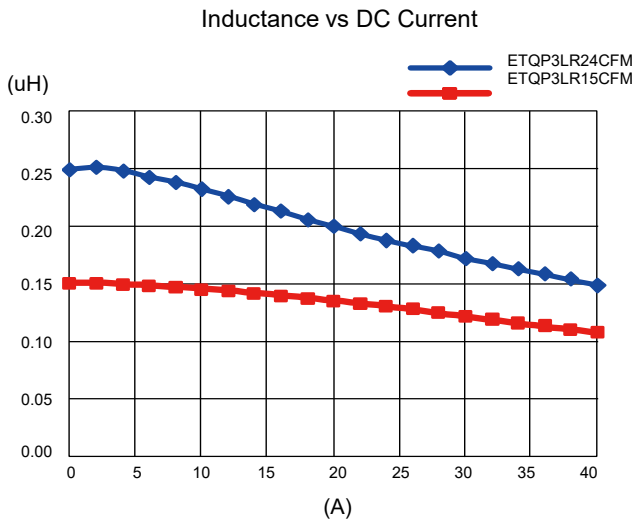

Dimensions in mm (not to scale)

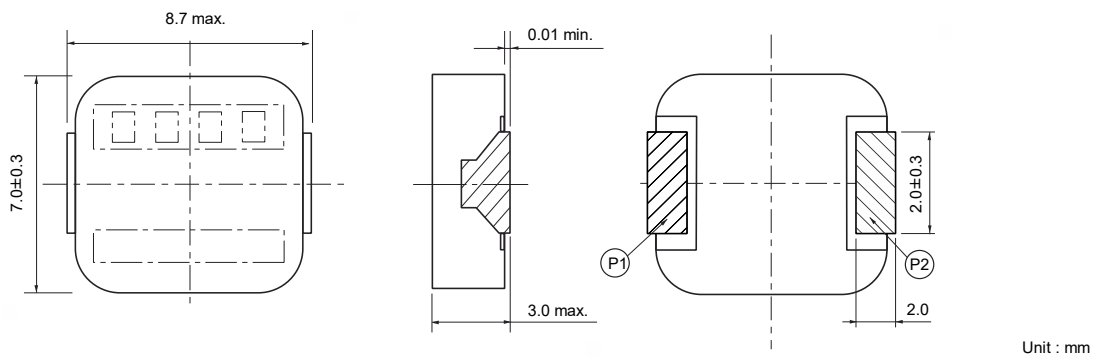

Connection

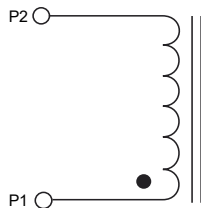

Recommended land patterns in mm (not to scale)

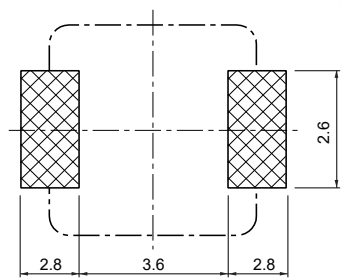

Unit : mm

- As for soldering conditions and safety precautions (Power choke coils for consumer use), please see data files.



Power Inductors

Power Choke Coil (Low DCR type)

PCC-M0740L (MC) series

Small mounting size for multi-phase DC/DC converter circuits

Industrial property : Patents 2 (Pending)

Features

- Small type (8.7×7.0×H4.0 mm)
- High power (17 A to 24 A)
- Low loss (DCR : 1.0 to 1.5 mΩ)
- Tighter DCR tolerance (±7 %)
- Suitable for high frequency circuit (up to 1 MHz)
- Low buzz noise due to its gap-less structure
- Shielded construction
- RoHS compliant

Recommended applications

- Notebook and Desktop PC power supply modules
- Servers, Routers, DC/DC converters for driving CPUs

Standard packing quantity (Minimum quantity/Packing unit)

- 3,000 pcs/box (2 reel)

Explanation of part numbers

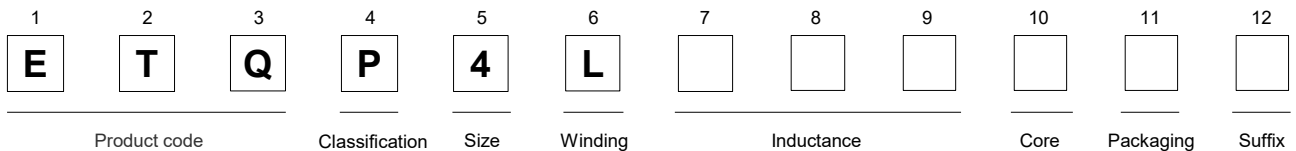

Standard parts

Part No.	Inductance (at 20°C) ^{*1}			Rated current (A) ^{*2}	Rated current (reference) (A) ^{*3}	DC resistance (at 20°C) (mΩ) max.
	L0 at 0A (μH)	L1 ^{*4}				
		(μH)	Measurement current (A)			
ETQP4LR15AFM	0.15±20 %	(0.13)	29	29	43.0	0.66±7 %
ETQP4LR24AFM	0.24±20 %	(0.20)	24	24	35.5	1.00±7 %
ETQP4LR36AFM	0.36±20 %	(0.30)	20	20	31.0	1.35±7 %
ETQP4LR42AFM	0.42±20 %	(0.35)	17	17	28.5	1.50±7 %

*1: Inductance is measured at 1.0 MHz.

*2: Rated current defines actual value of DC current, when temperature rise of coil becomes 40 K. (Method A)

*3: Rated current (reference) defines actual value of DC current, when temperature rise of coil becomes 40 K. (Method B)

*4: Reference only

◆ Method A (PANASONIC's standard measurement conditions), Method B (high heat dissipation measurement) is different from Method A by the measurement methods. In normal application condition, the part's temperature depends on circuit design and heat dissipation condition. This condition shall be verified by the worst operational condition.

Power Choke Coil (Low DCR type)

Performance characteristics (Reference)

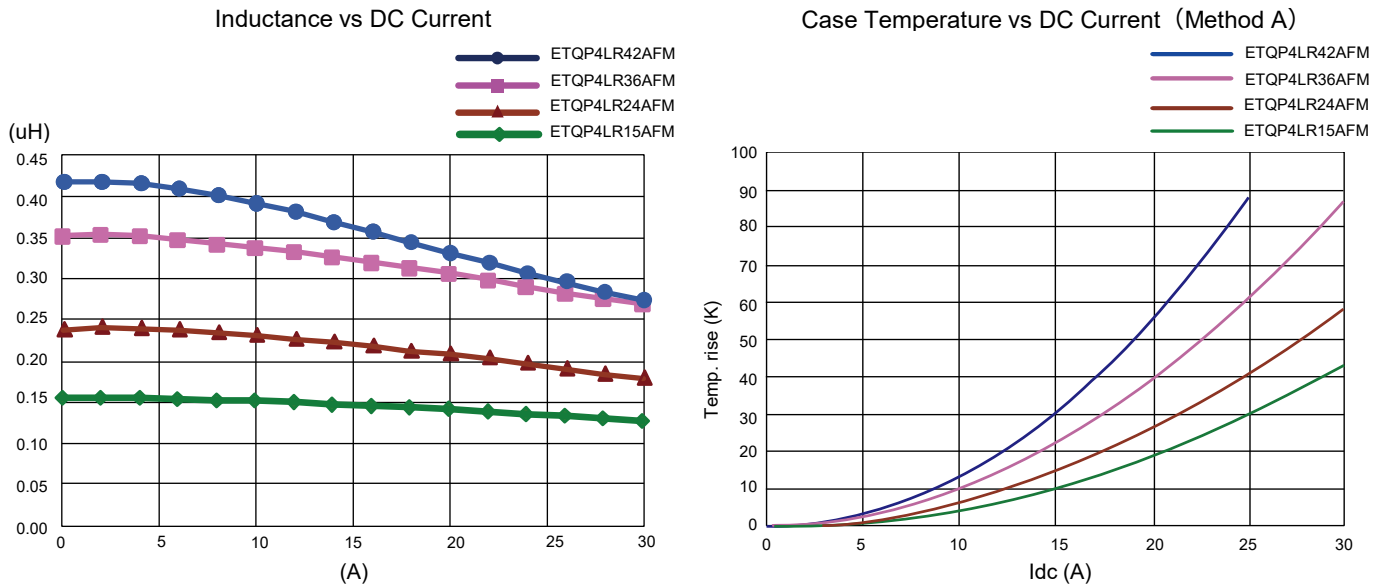

Dimensions in mm (not to scale)

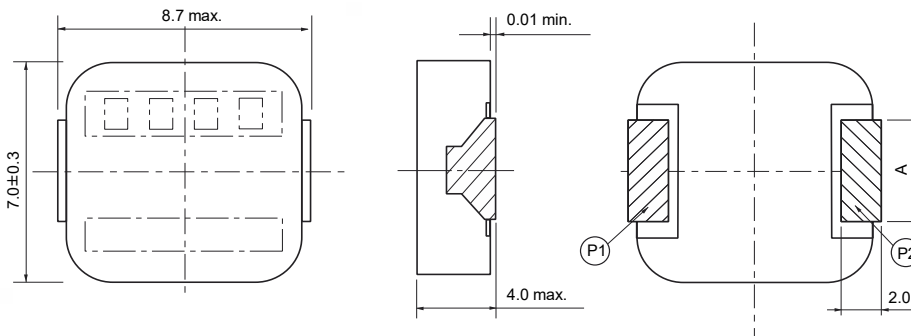

Unit : mm

Part No.	A
ETQP4LR15AFM	3.0±0.3
ETQP4LR24AFM	3.0±0.3
ETQP4LR36AFM	2.0±0.3
ETQP4LR42AFM	2.0±0.3

Connection

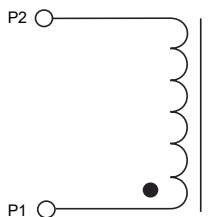

Recommended land patterns in mm (not to scale)

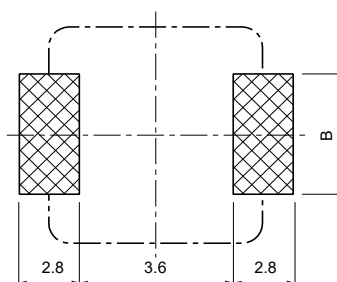

Unit : mm

Part No.	B
ETQP4LR15AFM	3.6
ETQP4LR24AFM	3.6
ETQP4LR36AFM	2.6
ETQP4LR42AFM	2.6

- As for soldering conditions and safety precautions (Power choke coils for consumer use), please see data files.

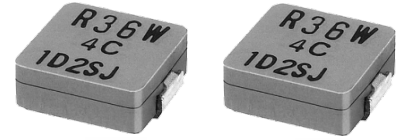

Power Inductors

Power Choke Coil

PCC-M1040L (MC) series

Small mounting size for multi-phase DC/DC converter circuits

Industrial property : Patents 4 (Pending)

Features

- Small type (11.5×10.0×H4.0 mm)
- High power (21 A to 28 A)
- Low loss (DCR : 0.7 to 1.56 mΩ)
- Tighter DCR tolerance (±5 % to ±10 %)
- Suitable for high frequency circuit (up to 1 MHz)
- Low buzz noise due to its gap-less structure
- Shielded construction
- RoHS compliant

Recommended applications

- Notebook and Desktop PC power supply modules
- Servers, Routers, DC/DC converters for driving CPUs

Standard packing quantity (Minimum quantity/Packing unit)

- 2,000 pcs/box(2 reel): ETQP4LR36WFC, ETQP4LR56WFC, ETQP4LR45XFC
- 1,000 pcs/box(2 reel): ETQP4LR19WFC

Explanation of part numbers

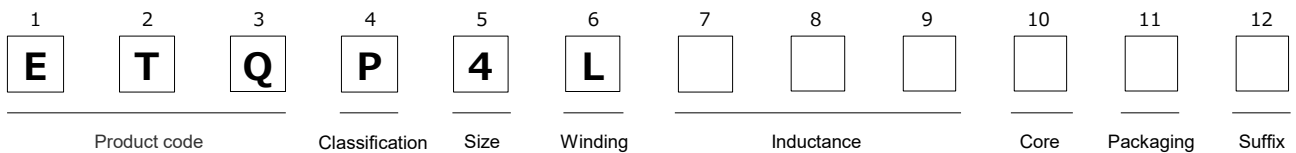

Standard parts

Part No.	Inductance (at 20°C) ^{*1}					Rated current (A) ^{*2}	Rated current (reference) (A) ^{*3}	DC resistance (at 20°C) (mΩ)
	L0 at 0A	L1		L2 ^{*4}				
	(μH)	(μH)	Measurement current (A)	(μH)	Measurement current (A)			
ETQP4LR19WFC	(0.2)	0.19±20 %	21	(0.17)	30	28	38	0.70±10 %
ETQP4LR36WFC	(0.37)	0.36±20 %	17	(0.34)	24	24	33	1.10± 5 %
ETQP4LR56WFC	(0.6)	0.56±20 %	15	(0.53)	21	21	28	1.56± 5 %
ETQP4LR45XFC	0.45 +20 % -25 %	—	—	(0.38)	25	25	33	1.10± 5 %

*1: Inductance is measured at 1.0 MHz.

*2: Rated current defines actual value of DC current, when temperature rise of coil becomes 40 K. (Method A)

*3: Rated current (reference) defines actual value of DC current, when temperature rise of coil becomes 40 K. (Method B)

*4: Reference only

◆ Method A (PANASONIC's standard measurement conditions), Method B (high heat dissipation measurement) is different from Method A by the measurement methods. In normal application condition, the part's temperature depends on circuit design and heat dissipation condition. This condition shall be verified by the worst operational condition.

Performance characteristics (Reference)

Inductance vs DC Current

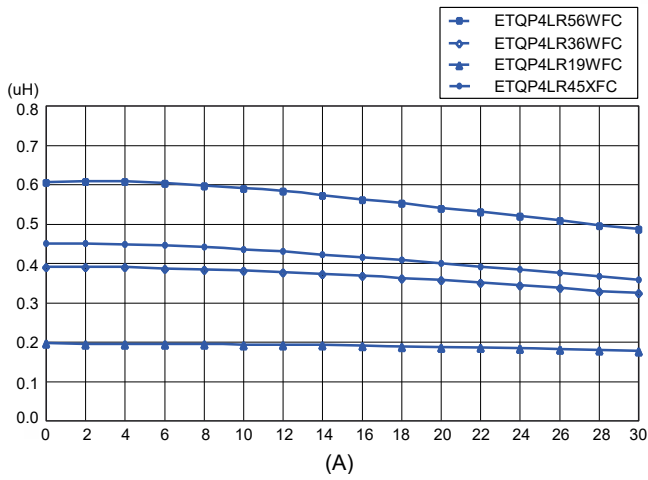

Case Temperature vs DC Current (Method A)

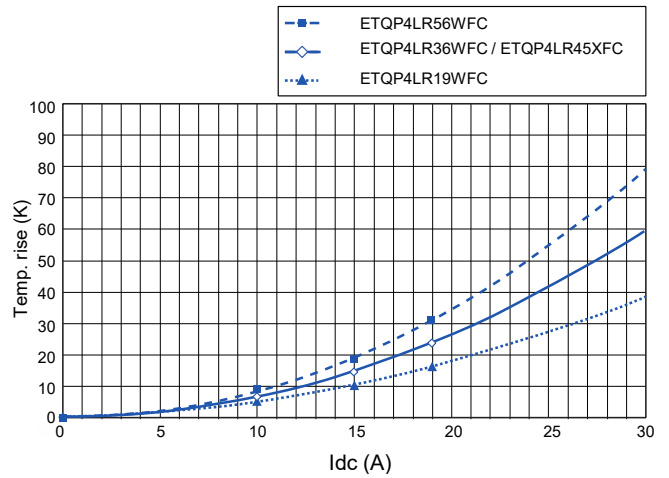

Dimensions in mm (not to scale)

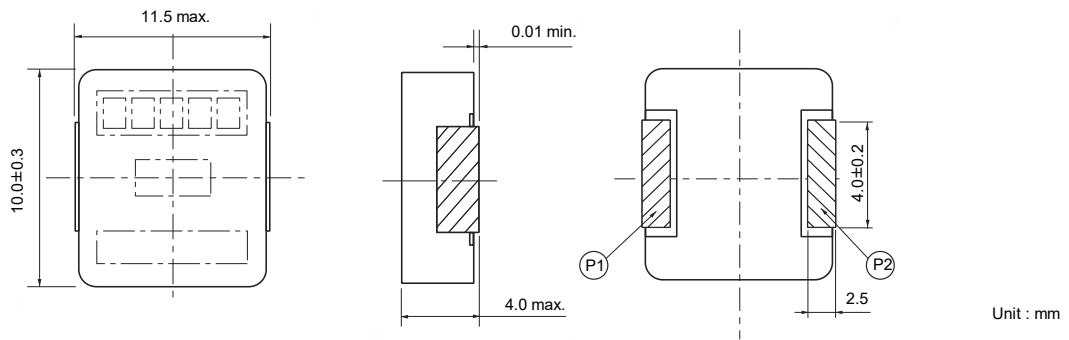

Connection

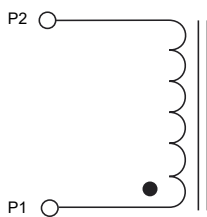

Recommended land patterns in mm (not to scale)

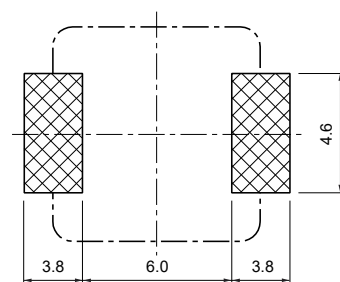

Unit : mm

■ As for soldering conditions and safety precautions (Power choke coils for consumer use), please see data files.



Power Inductors

Power Choke Coil (Low DCR type)

PCC-M1040L (MC) series

Small mounting size for multi-phase DC/DC converter circuits

Industrial property : Patents 2 (Pending)

Features

- Small type (11.7×10.0×H4.0 mm)
- High power (21 A to 30 A)
- Low loss (DCR : 0.76 to 1.58 mΩ)
- Tighter DCR tolerance (±5 %, ±7 %)
- Suitable for high frequency circuit (up to 1 MHz)
- Low buzz noise due to its gap-less structure
- Shielded construction
- RoHS compliant

Recommended applications

- Notebook and Desktop PC power supply modules
- Servers, Routers, DC/DC converters for driving CPUs

Standard packing quantity (Minimum quantity/Packing unit)

- 2,000 pcs/box (2 reel)

Explanation of part numbers

1	2	3	4	5	6	7	8	9	10	11	12
E	T	Q	P	4	L						
Product code	Classification		Size	Winding	Inductance			Core	Packaging	Suffix	

Standard parts

Part No.	Inductance (at 20°C) ^{*1}			Rated current (A) ^{*2}	Rated current (reference) (A) ^{*3}	DC resistance (at 20°C) (mΩ) max.
	L0 at 0A	L1 ^{*4}				
	(μH)	(μH)	Measurement current (A)			
ETQP4LR15AFC	0.15±20 %	(0.13)	42	42	51	0.45±7 %
ETQP4LR36AFC	0.36±20 %	(0.29)	30	30	40	0.76±5 %
ETQP4LR68XFC	0.68±20 %	(0.59)	21	21	28	1.58±5 %

*1: Inductance is measured at 1.0 MHz.

*2: Rated current defines actual value of DC current, when temperature rise of coil becomes 40 K. (Method A)

*3: Rated current (reference) defines actual value of DC current, when temperature rise of coil becomes 40 K. (Method B)

*4: Reference only

◆ Method A (PANASONIC's standard measurement conditions), Method B (high heat dissipation measurement) is different from Method A by the measurement methods. In normal application condition, the part's temperature depends on circuit design and heat dissipation condition. This condition shall be verified by the worst operational condition.

Power Choke Coil (Low DCR type)

Performance characteristics (Reference)

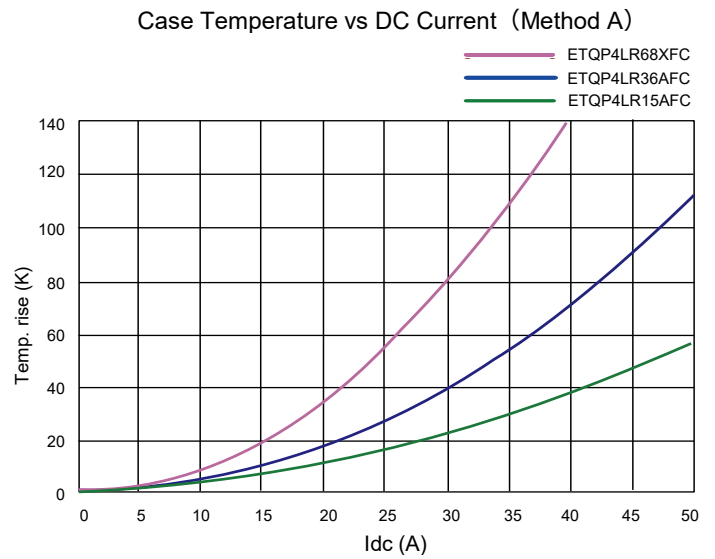
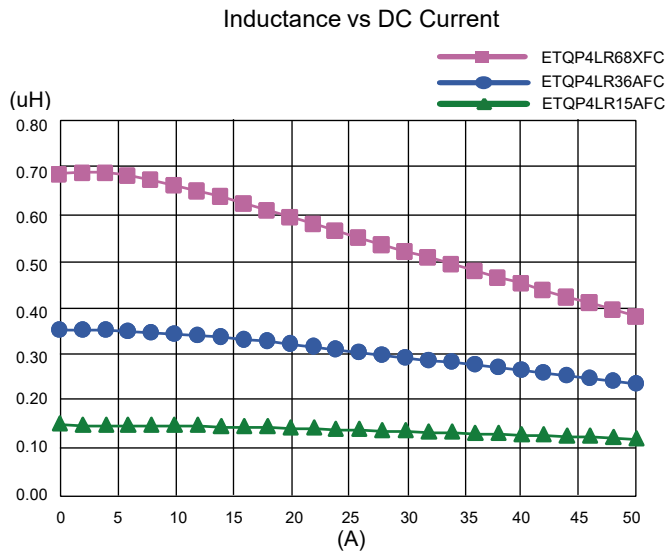

Dimensions in mm (not to scale)

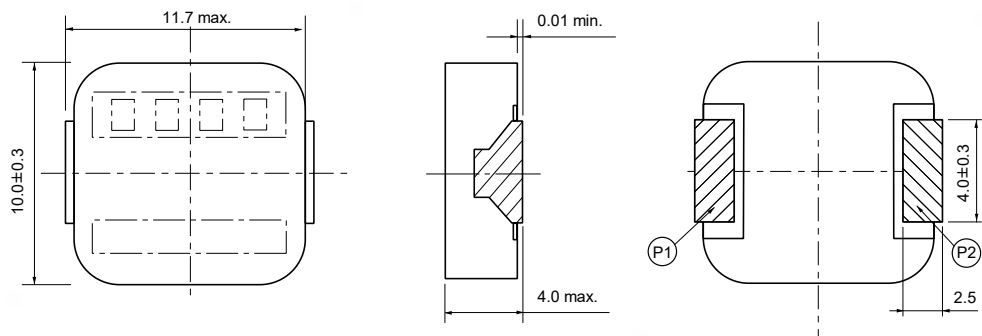

Unit : mm

Connection

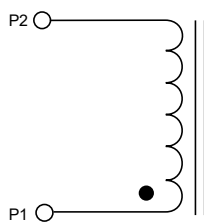

Recommended land patterns in mm (not to scale)

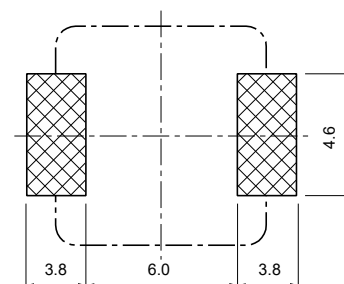

Unit : mm

- As for soldering conditions and safety precautions (Power choke coils for consumer use), please see data files.

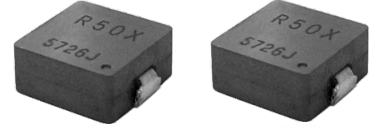

Power Inductors

Power Choke Coil

PCC-M1250L (MC) series

High power, Low loss, Low-profile

Industrial property : Patents 2 (Pending)

Features

- High power (25 A to 30 A)
- Low loss (DCR : 0.8 to 1.1 mΩ)
- Tighter DCR tolerance ($\pm 5\%$ to $\pm 7\%$)
- Low profile (14.5×12.5×H5.0 mm)
- Suitable for high frequency circuit (up to 1 MHz)
- Low buzz noise due to its gap-less structure
- Shielded construction
- RoHS compliant

Recommended applications

- Notebook and Desktop PC power supply modules
- Servers, Routers, DC/DC converters for driving CPUs

Standard packing quantity (Minimum quantity/Packing unit)

- 1,000 pcs/box (2 reel)

Explanation of part numbers

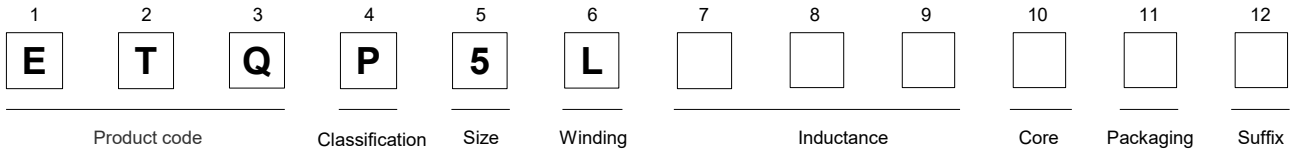

Standard parts

Part No.	Inductance (at 20°C) ^{*1}				Rated current (A) ^{*2}	DC resistance (at 20°C) (mΩ)
	L1		L2 ^{*3}			
	(μH)	Measurement current (A)	(μH)	Measurement current (A)		
ETQP5LR50XFA	0.50±20 %	30	(0.46)	42	30	0.80±7 %
ETQP5LR60XFA	0.60±20 %	30	(0.54)	42	27	1.10±5 %

*1: Inductance is measured at 1.0 MHz.

*2: Rated current defines actual value of DC current, when temperature rise of coil becomes 40 K.

*3: Reference only

Performance characteristics (Reference)

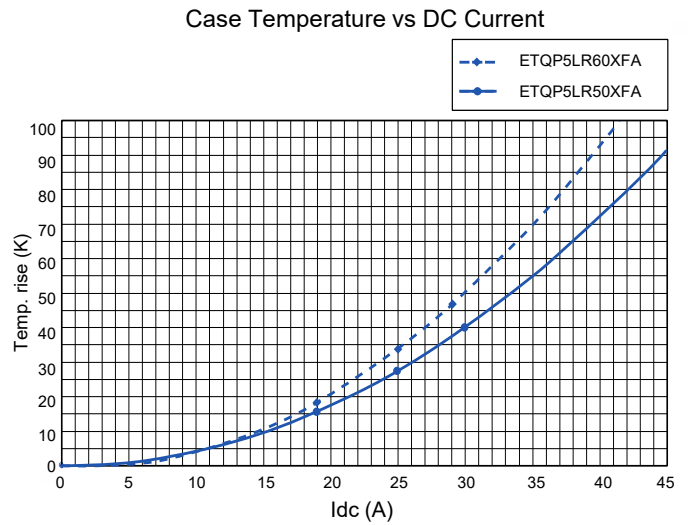
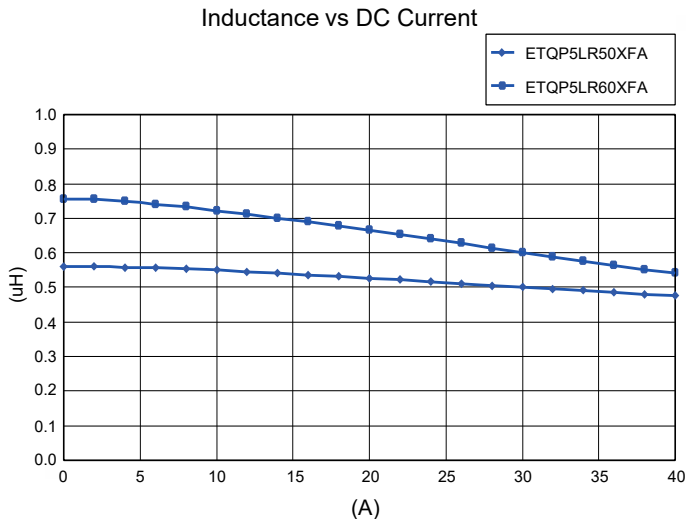

Dimensions in mm (not to scale)

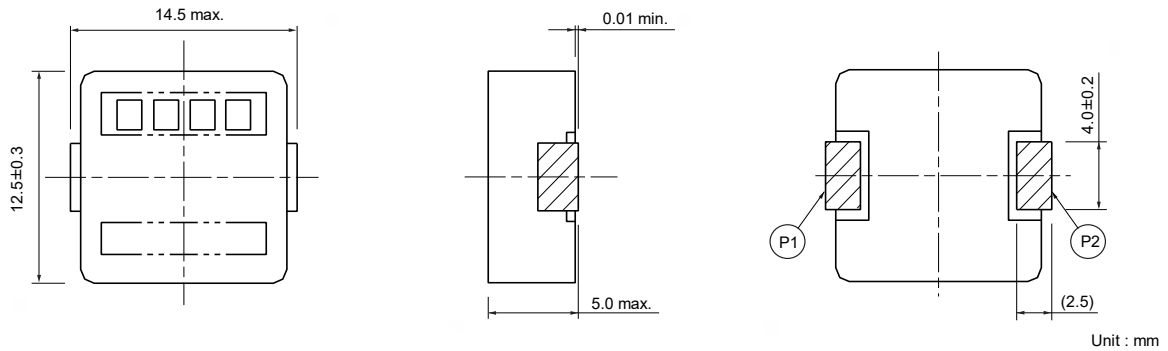

Connection



Recommended land patterns in mm (not to scale)

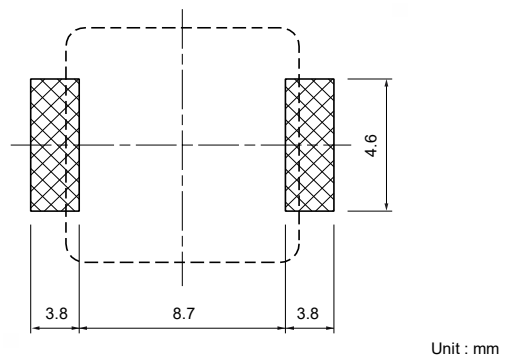

■ As for soldering conditions and safety precautions (Power choke coils for consumer use), please see data files.

Reflow soldering conditions

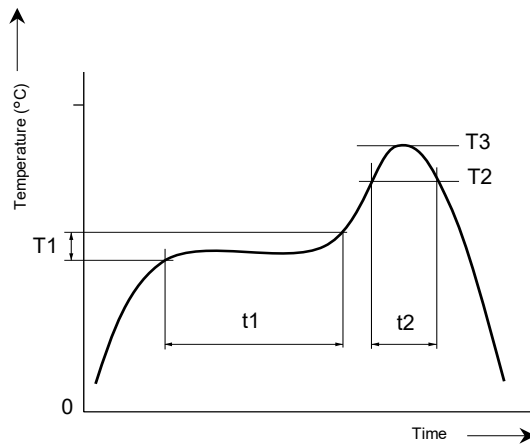

- Pb free solder recommended temperature profile
Power Choke Coils for Consumer use

Series	Preheat		Soldering		Peak temperature		Time of reflow
	T1 [°C]	t1 [s]	T2 [°C]	t2 [s]	T3	T3 Limit	
PCC-M0730L PCC-M0740L PCC-M1040L PCC-M1250L	150 to 170	60 to 120	230 °C	30 to 40	250 °C, 5 s	260 °C, 10 s	2 times max.

Packaging methods (Taping)

- Embossed carrier tape dimensions in mm (not to scale)

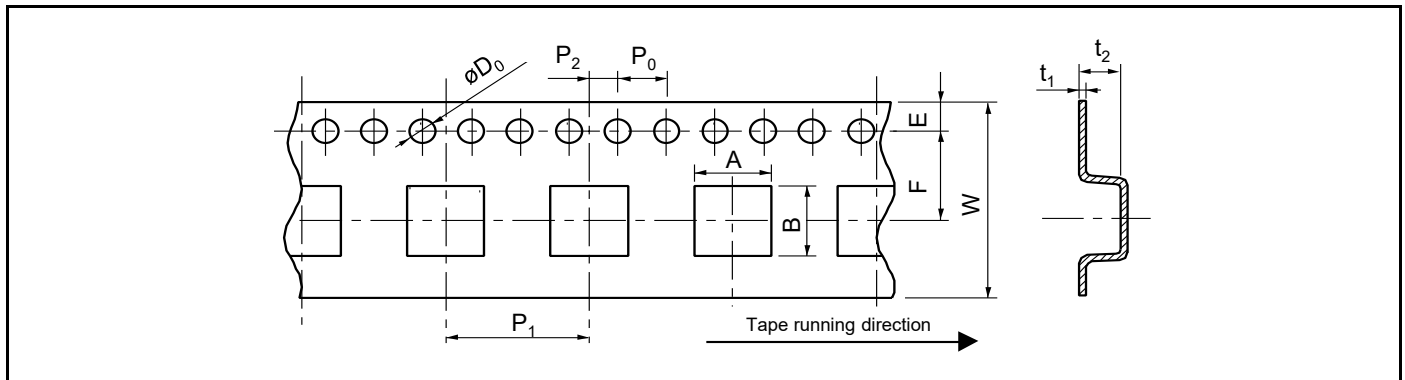

Series	A	B	W	E	F	P ₁	P ₂	P ₀	øD ₀	t ₁	t ₂
PCC-M0730L	7.6	8.9	16	1.75	7.5	12	2	4	1.5	0.4	4.2
PCC-M0740L	7.6	8.9	16	1.75	7.5	12	2	4	1.5	0.4	4.3
PCC-M1040L	10.6	11.8	24	1.75	11.5	16	2	4	1.5	0.4	5.2
PCC-M1250L	13.1	14.8	24	1.75	11.5	16	2	4	1.5	0.4	5.3

Unit : mm

- Taping reel dimensions in mm (not to scale)

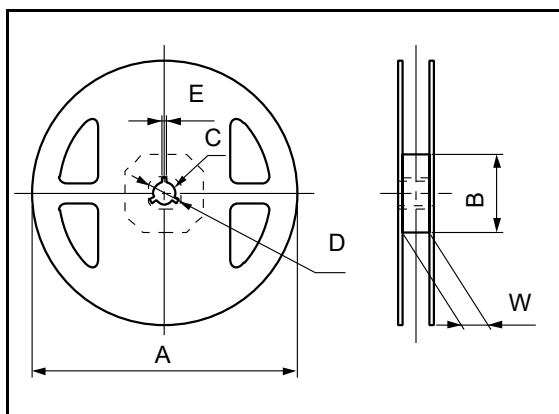

Series	A	B	C	D	E	W
PCC-M0730L	380	80	13	21	2	17.5
PCC-M0740L						
PCC-M1040L						
PCC-M1250L						25.4

Unit : mm

Component placement (Taping)

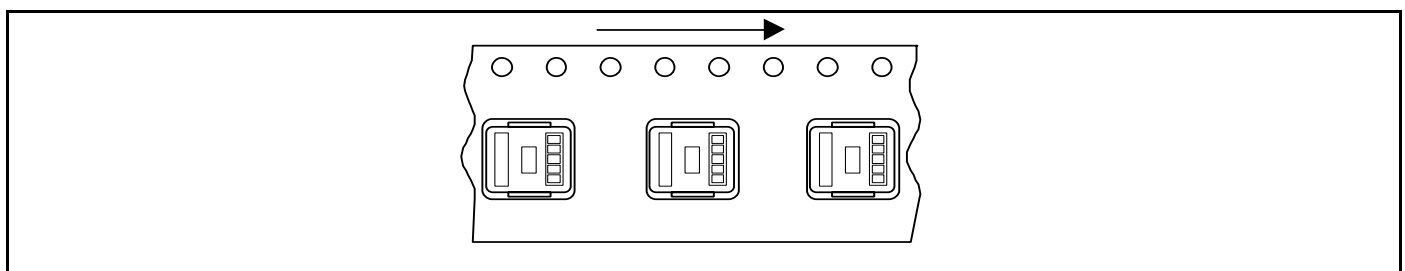

Standard packing quantity/Reel

Series	Part No.	Minimum quantity / Packing unit	Quantity per reel
PCC-M0730L	ETQP3L□□□CFM	3,000 pcs / box (2 reel)	1,500 pcs
PCC-M0740L	ETQP4L□□□AFM		
PCC-M1040L	ETQP4L□□□WFC	2,000 pcs / box (2 reel)	1,000 pcs
	ETQP4L□□□XFC		
	ETQP4L□□□AFC		
PCC-M1040L	ETQP4LR19WFC	1,000 pcs / box (2 reel)	500 pcs
PCC-M1250L	ETQP5L□□□XFA		

Safety Precautions

When using our products, no matter what sort of equipment they might be used for, be sure to confirm the applications and environmental conditions with our specifications in advance.

Panasonic
INDUSTRY

Panasonic Industry Co., Ltd.
Device Solutions Business Division

1006 Kadoma, Kadoma City, Osaka
571-8506 Japan