

Compact Laser Displacement Sensor

HL-G1 Series

User's Manual

Introduction





Thank you for purchasing the HL-G1-series Compact Laser Displacement Sensor. Read this manual carefully and be sure you understand the information provided before attempting to install and operate the product so that the product will fully demonstrate its superior performance. Refer to the website of Panasonic Industry Co., Ltd. (<https://industry.panasonic.com/>) for the latest information on the product as well as the latest version of the manual.

■ Notes

1. The illustrations of the product in the manual may differ from the actual design of the product.
2. The contents of this user's manual may change without notice for possible improvements in the future.
3. All rights reserved. No part of this publication may be reproduced, stored in a retrieval system, or transmitted, in any form, or by any means, mechanical, electronic, photocopying, recording, or otherwise, without the prior written permission of Panasonic Industry Co., Ltd.
4. The utmost attention has been paid to the creation of this manual. Should you find any errors, omissions or inaccuracies, contact the nearest office of Panasonic Industry Co., Ltd.
5. Panasonic Industry Co., Ltd. shall be in no case responsible for any consequences resulting from your operation of the product.

■ Conventions

The following conventions are used to indicate and classify precautions in this manual. Always heed the information provided with them.

 WARNING	Indicates information that, if not heeded, is likely to result in loss of life or serious injury.
 CAUTION	Indicates information that, if not heeded, could result in relatively serious or minor injury, damage to the product, or faulty operation.
 CHECK	Explains matters that should be observed or mistakes that the user is apt to make.
 REFERENCE	Explains items that should be kept in mind, relevant information in detail, and references.
 TECHNIQUE	Explains useful operating conditions and technical tips (know-how).

About this Manual

	Introduction Introduction provides precautions on the safe and correct use of this system. Be sure to read the precautions provided in this section.
Chapter 1	Before Use Chapter 1 provides information on the configuration, installation, and connection of the system (including the sensor head and Setting and monitoring software HL-G1SMI).
Chapter 2	I/O Terminal Block Chapter 2 provides information on the I/O lines of the sensor head.
Chapter 3	Functions Chapter 3 provides information on the functions of the system.
Chapter 4	Communications Chapter 4 provides information on RS-422 and RS-485 communications control.
Chapter 5	Control Troubleshooting Chapter 5 provides information on the troubleshooting of the system.
Chapter 6	Specifications Chapter 6 provides the specifications of the sensor head.

1

2

3

4

5

6

Table of Contents

About this Manual	1
Table of Contents	2
Safety Precautions	4
WARNING	4
Caution	4
Correct Handling	5
Installation Environment	5
Do not install the system in the following places.	5
Operating Environment	5
Ambient Temperature, Humidity, and Illuminance	5
Power Supply Voltage	6
Environment	6
Protective Structure	6
Warm-up Time	7
Countermeasures against Noise	7
Power Supply	8
Applicable Power Supply	8
Power Supply Sequence for Sensor Head	8
Instantaneous Power Failure	8
Operating Conditions for Compliance with CE Marking / UKCA Marking	9
Laser Product Handling	10
JIS/IEC/GB/KS	10
Laser Diode Sensor	10
Precautions	10
Warning label	11
FDA	12
Export to US	12
Maintenance and Inspection	13
Maintenance Instructions	13
Inspection	13
1 Before Use	1-1
1-1 System Configuration	1-2
1-1-1 System Configuration	1-2
1-1-2 List of System Components & Accessories	1-3
Sensor Head Accessories	1-3
Extension Cable for Sensor Head (Optional for High-function Type Only)	1-4
Setting and Monitoring Software HL-G1SMI (Optional for High-function Type Only)	1-4
Compact Console (Optional for High-function Type Only)	1-5

1-2 Part Names and Functions	1-6
1-3 Installation Method	1-7
Extension Cable	1-7
Mounting Direction of Sensor Head	1-8
1-4 Measurement of transparent objects	1-12

2 I/O Terminal Block

2-1 Functions and Arrangements of I/O Terminal Block	2-2
2-2 I/O Circuit	2-4
When using with NPN output (Connect NP switching input to 0V)	2-4
When using with PNP output (Connect NP switching input to +V)	2-5
2-3 Analog Output Circuit	2-6
2-4 Timing Chart	2-7
2-5 Conditions When Output Data Become Unfixed	2-9

3 Functions

3-1 Classification of Functions	3-2
3-2 Function List & Initial Values	3-2
3-3 Operation of Each Function	3-5
3-3-1 Basic Operation	3-5
Panel Configuration	3-5
Basic Operation	3-6
Screen Transition in Setting Mode	3-9
3-3-2 Memory Change	3-11
3-3-3 Sensing Setting	3-13
Sampling Cycle	3-13
Shutter Time	3-14
Light Intensity Monitor	3-15
3-3-4 Data Processing Settings	3-16
Average Times	3-16
Analysis Mode	3-17
Span	3-19
Offset	3-21
Zero-set OFF	3-22
3-3-5 Output Settings	3-23
Judgment Output Selection	3-23
Displacement Judgment	3-25
Judgment Output OFF Delay	3-27
Measurement Value Display on Panel	3-29
3-3-6 Analog Settings	3-30

▪ Analog Output Selection	3-30
▪ Analog Scaling	3-31
3-3-7 Alarm Settings	3-33
▪ Analog Output at Alarm	3-33
▪ Digital Output at Alarm	3-34
▪ Alarm Delay Times	3-35
3-3-8 COM Settings	3-36
▪ Terminating Resistor Selection	3-36
▪ Sensor No.	3-37
▪ Baud Rate	3-38
▪ Connection Mode	3-39
▪ Sending Delay Time	3-40
3-3-9 System Settings	3-41
▪ Timing Mode	3-41
▪ Laser Control	3-42
▪ Eco Mode	3-43
▪ View Version	3-44
3-3-10 Other System Settings	3-45
▪ Initialize	3-45
▪ Save	3-46
3-3-11 Measurement Control with External Input	3-47
▪ Timing	3-47
▪ Zero Set	3-47
▪ Reset	3-49
3-3-12 Buffering Settings (High-function type only)	3-50
▪ Data Buffering Operation	3-51
▪ Buffering Mode	3-52
▪ Buffering Rate	3-53
▪ Accumulated Amount	3-53
▪ Trigger Points	3-54
▪ Trigger Delay	3-54
▪ Trigger Conditions	3-55
▪ Buffering Operation	3-56
▪ Status Readout	3-56
▪ Last Data Point	3-56
▪ Binary Readout of Buffering Data	3-57
4 Communications Control	4-1
4-1 Communications Specifications	4-2
▪ Specifications	4-2
▪ Pin Arrangement	4-2
▪ Connecting Example with External Device	4-3
▪ Communications Protocol	4-6
▪ Communications Condition Changes	4-6
4-2 Type and Format of Commands	4-7
4-2-1 Commands	4-7
▪ Data Transmission/Reception	4-7
4-2-2 Command Formats	4-9
<small>FORMAT</small> 1 General Purpose	4-9
<small>FORMAT</small> 2 Value Setting	4-10
<small>FORMAT</small> 3 All Outputs Read	4-12

<small>FORMAT</small> 4 Normal Read of Buffering Data	4-13
<small>FORMAT</small> 5 Read of Differential Data in Buffering Data	4-14
<small>FORMAT</small> 6 Binary Read of Buffering Data	4-14
<small>FORMAT</small> 7 RS-422 Timing (or RS-422 Continuous) Output Mode	4-15
▪ Error Response	4-16
▪ BCC	4-18
4-3 Command List	4-19
▪ Basic Settings	4-19
▪ Data Processing Settings	4-19
▪ Output Settings	4-20
▪ Analog Settings	4-21
▪ Alarm Settings	4-21
▪ System Settings	4-22
▪ Read Commands	4-23
▪ Buffering Commands	4-23
4-4 Setting Address List	4-25
▪ Command Formats(MEWTOCOL)	4-26
▪ Error Response	4-26
▪ Sensing Settings	4-27
▪ Data Processing Settings	4-27
▪ Output Settings	4-28
▪ Analog Settings	4-28
▪ Alarm Settings	4-29
▪ System Settings	4-29
▪ Data Readout	4-29
▪ Buffering settings	4-30
▪ Setting for Programmable Display (GT Series)	4-31
5 Troubleshooting	5-1
5-1 Corrective Actions	5-2
5-2 Initialization	5-6
6 Specifications	6-1
6-1 Sensor Head Specifications	6-2
6-2 Dimensions	6-8
▪ Sensor Head	6-8
6-3 Characteristics	6-13
▪ Beam Diameter	6-13
▪ Mutual Interference Area	6-15
▪ Output Characteristics	6-18
Revision history	6-20

Safety Precautions

This product is used to detect objects, and does not incorporate control functions for the purpose of maintaining safety including the prevention of accidents.

Do not use this product as a human sensor to protect human bodies.

Use products that conform to the laws, regulations, and international standards, such as OSHA, ANSI, and IEC standards, for applications protecting human bodies.

In order to ensure the correct use of the product, read this user manual carefully before use.

WARNING

- Incorporate safety measures, such as a double safety mechanism, into the system if the use of the system is likely to result in injury or serious consequential loss.
- Do not use the system in combustion gas atmospheres. Otherwise, the system may result in explosion.
- This product was developed and manufactured for use in industrial environments.

CAUTION

- Always observe the specifications including the ratings and ambient conditions.
Otherwise, the system may result in overheating or generate smoke.
- Do not disassemble or modify the system. Otherwise, an electric shock may be received or the system may generate smoke.
- Do not touch the wires when the system is energized. Otherwise, an electric shock may be received.

Correct Handling

Pay attention to the following items when installing and using the system.

Installation Environment

- Do not install the system in the following places.
 - Places where the ambient temperature, humidity, or the illumination level of the light receiving surface is in excess of the operating environmental conditions. (→ Refer to “Operating Environment”).
 - Places that causes dew condensation as a result of radical temperature changes.
 - Places with corrosive gas or flammable gas.
 - Places with excessive dust, iron powder, or salt.
 - Places where organic solvents, such as benzine, paint thinner, and alcohol, and strong alkaline substances, such as ammonia and sodium hydroxide are likely to adhere to the system.
 - Places with strong vibration and shock.
 - Places exposed to direct sunlight.
 - Places where oil, or chemicals are sprayed.
 - Places where a heavy load is imposed on the sensor head.

Operating Environment

■ Ambient Temperature, Humidity, and Illuminance

Ambient temperature

- Use the system within the range of the specifications (→ refer to Chapter 6 “Specifications”).
Sensor head: -10°C to $+45^{\circ}\text{C}$
- Keep the following storage temperature range in the case of storing the sensor head.
Sensor head: -20°C to $+60^{\circ}\text{C}$
- The life of the semiconductor laser depends on the operating ambient temperature. Take appropriate measures, such as the use of a cooling fan, to drop the ambient temperature of the sensor head as much as possible if the sensor head is used close to heat radiating objects.
- The sensor head radiates heat as well. Therefore, be sure to install the sensor head in places with as good thermal conductivity as possible. Mount the sensor head to an aluminum or steel plate with a minimum surface area of 200 cm^2 if the

ambient temperature is 40°C or higher.

In the case of installing two or more sensor heads in parallel, mount each sensor head to an aluminum or steel plate with a minimum surface area of 200 cm² and make sure that the ambient temperature does not exceed 40°C.

Ambient humidity

- Use the system within a relative humidity (RH) range of 35% to 85%.
Do not use the system in places that may cause dew condensation as a result of radical temperature changes.

Ambient illuminance of light receiving surface

Make sure that the illumination level of the light receiving surface does not exceed 3,000 lx under incandescent light.

■ Power Supply Voltage

Be sure to supply a rated voltage of 21.6 to 26.4 VDC.

■ Environment

- The internal circuit may be damaged if an external surge voltage (single-polarity, full-wave voltage) in excess of 500 V \pm 1.2 x 50 μ s is imposed. Insert a surge absorber between power input terminals if the external surge voltage is likely to exceed 500 V.
- Always keep the emitter and receiver of the sensor head clean. Make sure that the emitter and receiver are free of substances that refract light, such as water, oil, or fingerprints, or surface water, or matters that block light, such as dust and dirt. Clean the emitter and receiver with a soft lint-free cloth or lens cleaning paper.
- Check that the receiver will not receive direct ambient light the same as the laser light in wavelength, such as sunlight. Mount an appropriate object, such as a light shield plate, to the sensor head if high accuracy is especially required.
- Do not use the system in places with flammable or corrosive gas or excessive dust, places where water is sprayed, places exposed to direct sunlight, or places with strong vibration or shock.

Protective Structure

- The sensor head is of penetration-resistant type, but the connector is not of dust-, water-, or corrosion-proof construction. Therefore, Do not use the product underwater or in the rain. Pay attention to the operating environment.

Warm-up Time

In order to ensure the performance of the system, allow a warm-up time of at least 30 minutes after the system is turned ON.

Countermeasures against Noise

- Install the system separated as much as possible from noise generating sources, such as high-tension lines, high-voltage equipment, power lines, power equipment, machines generating high-voltage ON/OFF surges, welding machines, and inverter motors.
- Install the system separated as much as possible from radio equipment incorporating transmission circuitry, such as amateur radio transmitters.
- Do not touch the connector parts when the system is energized. Keep in mind that the internal circuit may be damaged if an excessive level of static electricity is imposed on the connector parts.
- Separate the sensor cable from other wires at least 100 mm, and make sure that the sensor cable is not in parallel with them. Separate the sensor cable from high-voltage and power circuit lines. Shield the sensor cable with grounded conduits if it is unavoidable to lay the sensor cable together with high-voltage or power circuit lines.
- Separate the I/O signal lines at least 100 mm away from power lines and power supply lines. All signal lines should be connected as short as possible.
- The analog output of the system is adversely influenced by heavy noise in the power supply. In that case, use a noise filter or noise-cut transformer.
- It is recommended to use shield cables for I/O signal wires and connect the shields to the frame ground (FG) for countermeasures against noise.
- The analog output is easily affected by external noise. Use the shield cable and lay it as short as possible.

Power Supply

■ Applicable Power Supply

- Select a power supply with a maximum ripple of 0.5 V (peak to peak) and a minimum current capacity of 0.5 A.
- Be sure to ground the FG terminal in order to prevent an adverse influence of high-frequency noise if a commercially available switching regulator is used for the power supply.
- A transformer may be connected to the power supply on the condition that the transformer is of isolation type. The product or the power supply may be damaged if an auto transformer is used.
- In order to protect the system from abnormally high voltages from the power supply line, be sure to use an isolated power supply with a built-in protective circuit.
- In the case of using a power supply that does not incorporate a protective circuit, be sure to connect the power supply to the system through a protective element, such as a fuse.

■ Power Supply Sequence for Sensor Head

- Arrange a power supply sequence so that the sensor head will be turned ON earlier than the I/O power supply.
- Arrange a power supply sequence so that the I/O power supply will be turned ON earlier than the sensor head.
- Do not turn ON the sensor head again within 10 seconds after the sensor head is turned OFF.
- The system will be ready to operate approximately 40 to 50 seconds after the system is turned ON, depending on the contents of settings. No outputs are determined during startup. Do not output anything during the period.
- An analog voltage of 11 V and an analog current of approximately 21.6 mA will be output until the system becomes ready to operate.
- Do not turn OFF the system while system settings are being saved. In the worst case, the sensor head system may be damaged and fail to restart.

Instantaneous Power Failure

If an instantaneous power failure occurs, the system will operate continuously or go to the initial power-on state, depending on the duration of the power failure. Do not use the system in environments where instantaneous power failures occur.

Operating Conditions for Compliance with CE Marking / UKCA Marking

This product complies with the following standards.

<Conformity Directives / Conforming Regulations>

EU Law : EMC Directives 2014/30/EU

British Legislation : EMC Regulations 2016/1091

- Applicable Standards

EN 61000-6-4:2007 +A1:2011, EN 61000-6-2:2005, EN IEC 63000:2018

When using as a product in conformity with CE Marking and UKCA Marking, observe the following requirements and conditions.

- Make sure that the length of signal and power lines connected to the product is less than 30 m.
- Mount the ferrite core to the head cable as shown below.
Recommended ferrite core: E04SR200935AB manufactured by Hoshino Electric, or equivalent

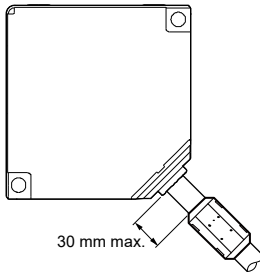

Laser Product Handling

IEC/EN/JIS/GB/KS

■ Laser Diode Sensor

For the purpose of preventing any injury which may occur to the user by the use of the laser product in advance, the following standards have been established by the IEC Standards, EN Standards, JIS Standards, GB Standards and KS Standards.

IEC : IEC 60825-1:2014
 EN : EN 60825-1:2014/A11:2021
 JIS : JIS C 6802:2014
 GB : GB 7247.1-2012
 KS : KS C IEC 60825-1:2014

These standards classifies laser products according to the level of hazard and provide the safety measures for respective classes.

Classification

Classification according to IEC 60825-1:2014(EN 60825-1:2014/A11:2021)

Class	Model	Summary of hazard evaluation
Class 2	HL-G1□□-S-J HL-G1□□-A-C5	A laser that emits visible light with the wavelength range of 400 nm to 700 nm under which eyes can be protected by an aversive reaction (Avoidance behavior) such as a blink.
Class 1	HL-G1□□-A-RS-J HL-G1□□-A-RA-C5	A laser that is safe when operated under operating conditions that can be reasonably foreseen.

When an unexpected failure occurs, dangerous radiation may be generated. Therefore, pay special attention to safety.

■ Precautions

- 1) Avoid observing beams continuously, particularly in a dark surrounding environment.
- 2) Do not look at beams using an optical device such as an optical telephoto system.
- 3) Install the sensor so the laser beam will be located higher or lower than eye level in order not to watch the beam directly while the system is in operation.
- 4) Never attempt to disassemble, repair, or modify this product.
- 5) Do not use the system in methods other than that specified in this manual.

 CAUTION	You may be exposed to hazardous laser radiation if the system is controlled or adjusted in procedures not specified in this manual.
--	---

- 6) Read the descriptions of the Warning label / Explanation label carefully before use.

The Warning label (English) / Explanation label is affixed to the side of the sensor head. Warning labels in Japanese, Korean, and Chinese are enclosed. Use them as needed.

■ Warning label / Explanation label

● Diffuse reflection type

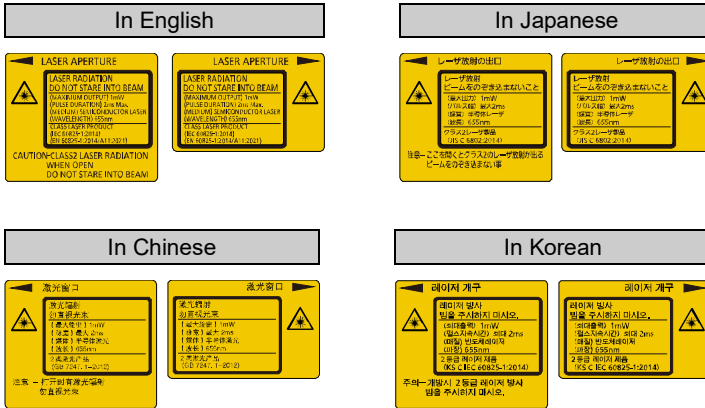

<Label position>

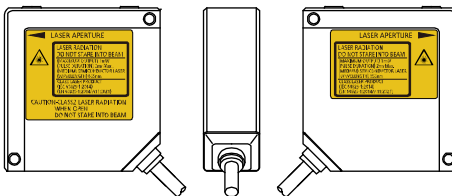

● Specular reflection type



<Label position>

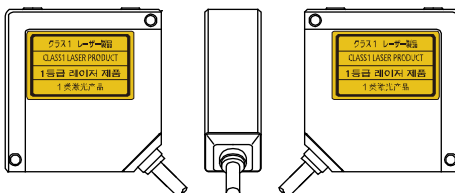

FDA

■ Export to US

The laser product mounted on equipment and exported to the United States is subjected to the regulation of the Food and Drug Administration (FDA). In order to prevent the users' injury caused by laser products, the FDA specifies PART 1040 (Performance Standards for Light-Emitting Products). The FDA classifies laser products according to the degree of risk and provides safety measures for respective classes.

This product complies with the FDA regulations (FDA 21 CFR 1040.10 and 1040.11) in accordance with FDA Laser Notice No. 56, except for complying with IEC 60825-1 Ed. 3.

● FDA certificate / identification label

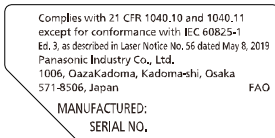

<Label position>

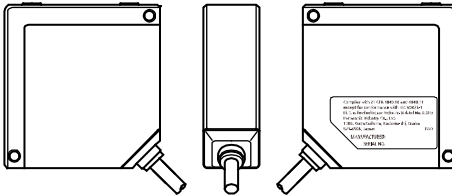

Maintenance and Inspection

■ Maintenance Instructions

- Be sure to turn OFF the system to stop laser emission before cleaning the system.
- Molded resin is used in some parts of the system. Do not use organic solvents such as paint thinner or benzene to wipe the dirt on the system.
- Do not wipe the front cover portion of the laser aperture too strongly. Scratches on the front cover may cause measurement errors.

(1) Cleaning Emitter and Receiver on Front Side of Sensor Head

- Always keep the emitter and receiver of the sensor head clean. Make sure that the emitter and receiver are free of substances that refract light, such as water, oil, or fingerprints, or surface water, or matters that block light, such as dust and dirt. Inspect the surfaces regularly and always keep them clean.
- Blow away large particles of dust, if any, using a camera lens blower.
- To remove small particles of dust or fingerprints, wipe lightly with soft lens cleaning cloth or lens cleaning paper. Do not use any organic solvent such as thinner, benzene or alcohol.

■ Inspection

Inspect the system regularly to maintain the performance of the system and make it possible to use the system under optimum conditions.

● Major Inspection Items

- Check that no I/O terminal connections are loose or disconnected.
- Check that the front cover on the laser aperture is free of dust, dirt or fingerprints.
- Check that the power supply voltage is within the rated range (21.6 to 26.4 VDC).
- Check that the operating ambient temperature during use is within the specification range (a sensor head temperature range of -10°C to 45°C).
- Check that operating ambient humidity (RH) is within a range of 35% to 85%.



1

Before Use

This Chapter provides information on the configuration, installation, and connection of the system (including the sensor head and Setting and Monitoring Software HL-G1SMI).

1-1 System Configuration	1-2
1-1-1 System Configuration	1-2
1-1-2 List of System Components & Accessories	1-3
1-2 Part Names and Functions	1-6
1-3 Installation Method	1-7

1-1 System Configuration

1-1-1 System Configuration

The system configuration and equipment connecting cables are shown below.

1

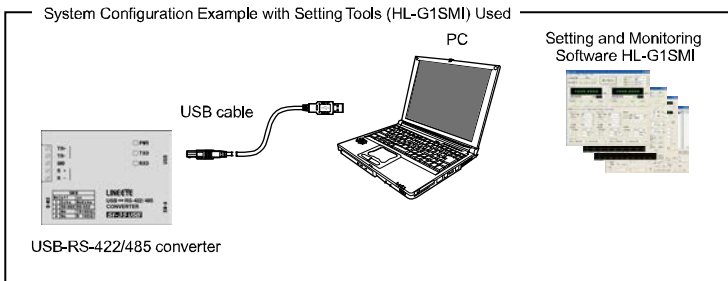
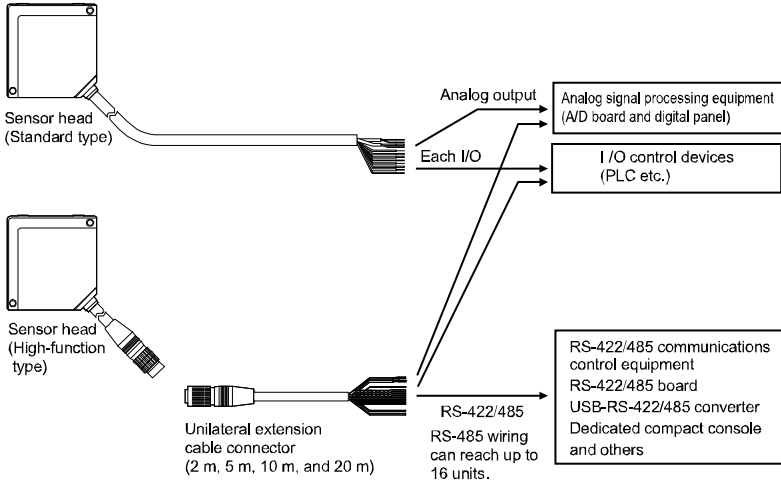

USB-RS-422/485 converter

Recommended: SI-35USB (LINEEYE made) or GT02 series or GT12 series (Panasonic Industry made)

The user may use a different converter at the user's own discretion.

❶ CHECK

Dedicated software (to be downloaded from the website of Panasonic Industry) is required if the GT02 or GT12 series is used as a converter.

1-1-2 List of System Components & Accessories

■ Sensor Head Accessories

The accessories of the sensor head are shown below.

Sensor head (Standard type)

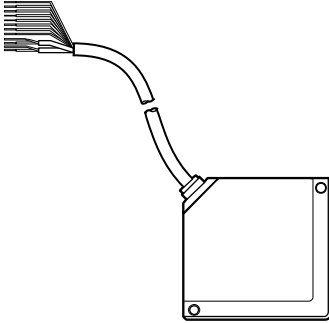

Sensor head (high-function type)

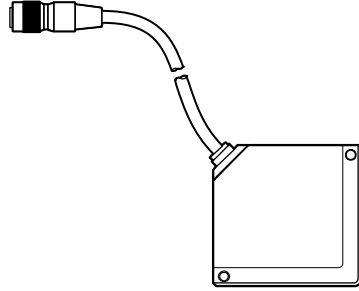

1

Sensor Head Instruction Manual

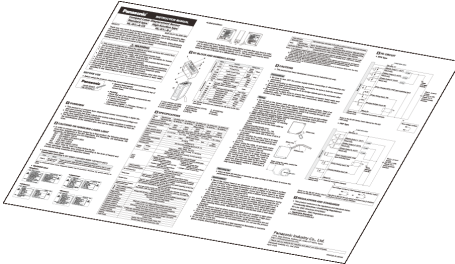

Japanese / English and
Chinese / Korean

Warning label / Explanation label

●Diffuse reflection



Sticker: English

Attachments: Japanese x 1 set

Chinese x 1 set

Korean x 1 set

●Specular reflection

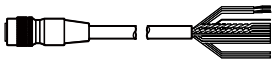
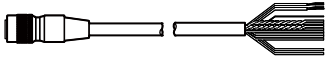
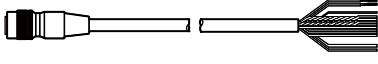
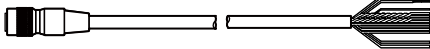

- **Extension Cable for Sensor Head (Optional for High-function Type Only)**

2 m		HL-G1CCJ2
5 m		HL-G1CCJ5
10 m		HL-G1CCJ10
20 m		HL-G1CCJ20

- **Setting and Monitoring Software HL-G1SMI (Optional for High-function Type Only)**

Software for the Setting and Monitoring Software HL-G1SMI can be downloaded from the website of Panasonic Industry Co., Ltd. (<https://industry.panasonic.com/>).

■ Compact Console (Optional for High-function Type Only)

The GT-series Programmable Display of Panasonic Industry Co., Ltd. is available as a compact console for the HL-G1. Write dedicated screen data to the Programmable Display so that the Programmable Display will display HL-G1 settings and measurement values transmitted over RS-422 and RS-485 communication.

Compact Console

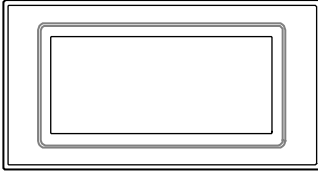

Compact console brackets and screws

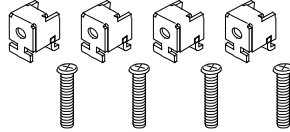

Terminal block for compact console



GT-series product numbers applicable

No. of connection units	Product name	Screen	Backlight	Body color	Part no.
Single connection	GT02G	3.8-type STN 240 x 96 dots	Green/Orange/Red	Pure black	AIG02GQ14D
				Hairline silver	AIG02GQ15D
	GT02M		White/Pink/Red	Pure black	AIG02MQ14D
				Hairline silver	AIG02MQ15D
Multi connection (1 to 4 units)	GT12G	4.6-type STN 320 x 120 dots	Green/Orange/Red	Pure black	AIG12GQ04D AIG12GQ14D
				Hairline silver	AIG12GQ05D AIG12GQ15D
	GT12M		White/Pink/Red	Pure black	AIG12MQ04D AIG12MQ14D
				Hairline silver	AIG12MQ05D AIG12MQ15D

❶ CHECK

The screen data and User's Manual (Console-dedicated version) can be downloaded from the website of Panasonic Industry Co., Ltd. (<https://industry.panasonic.com/>).

1-2 Part Names and Functions

1

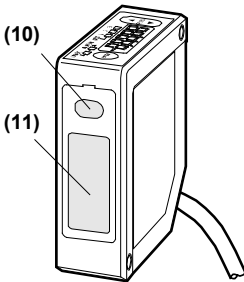
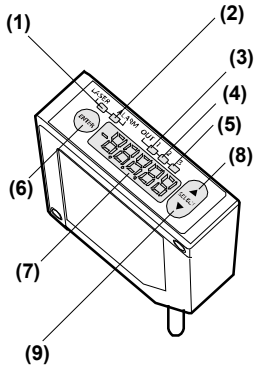

(1) **Laser Indicator (LASER)**

Lights up in green during laser emission.

(2) **Alarm Indicator (ALARM)**

Lights up in orange if a measurement alarm results.

(3) **OUT1 Indicator (OUT1)**

Lights up in yellow during OUT1 output.

(4) **OUT2 Indicator (OUT2)**

Lights up in yellow during OUT2 output.

(5) **OUT3 Indicator (OUT3)**

Lights up in yellow during OUT3 output.

(6) **[ENTER] Key**

Used to enter items.

(7) **Digital Display**

Displays measurement values and system errors.

(8) **[UP] Key**

Used to select items.

(9) **[DOWN] Key**

Used to select items.

(10) **Emitter**

Emits the laser light.

(11) **Receiver**

Receives reflected light from measurement targets.

1-3 Installation Method

Before installing each device, read carefully the explanation of the setting environment, concern about noise and radiation, and power supply.

(→ Refer to “Introduction” – “Correct Handling”.)

Fix the sensor head securely with M4 screws inserted into the two screw holes of the sensor head.

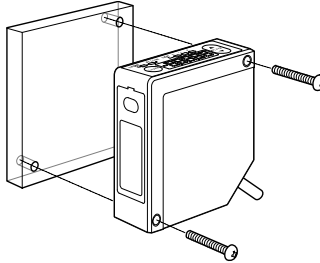

❗CHECK

- The tightening torque should be 0.8N·m or less.
- Never impose force around the connectors of the sensor head cable and extension cable. Do not bend the cables near the connectors. Doing so may result in cable disconnection.

■ Cable Wiring

- Do not pull the cable with a force of 29.4 N or greater.
- When bending the cable, bend it at least 20 mm away from the cable lead-out part with the minimum bending radius of 30 mm or more.
- When wiring the cable, do not apply undue stress to the base of the cable connection and unwind the cable from the roll.
- When moving the sensor head during operation, be careful not to apply excessive bending stress to the cable. The cable in the moving part may be damaged. Therefore, use an extension cable for the moving part and, when the extension cable is damaged, immediately replace it. Otherwise, it may result in failure.

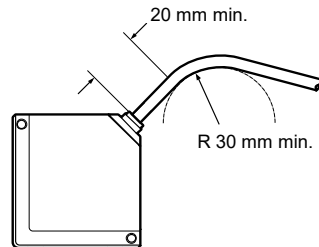

When wiring the cable, unwind the cable from the roll.



■ Mounting Direction of Sensor Head

Mount the sensor head in the direction shown below toward the measuring target in order to ensure the precise and stable measurement operation of the sensor head.

- Installation direction toward the moving target
- Measurement of targets with extremely different adjacent colors or materials

When measuring a moving target that has extremely different adjacent colors or materials, set the direction of the sensor head as shown below in order to minimize the measurement error of the sensor head.

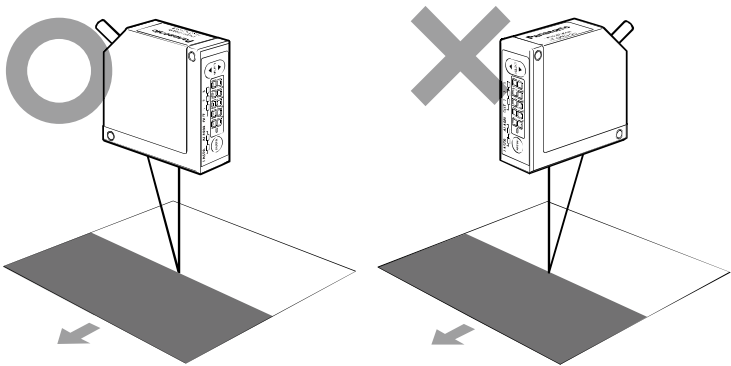

- When mounting the sensor head to a wall surface

Set the direction of the sensor head as shown below so that the receiver will not receive multi-reflected light from the wall. If the wall reflectance is high, painting the surface matte-black is effective.

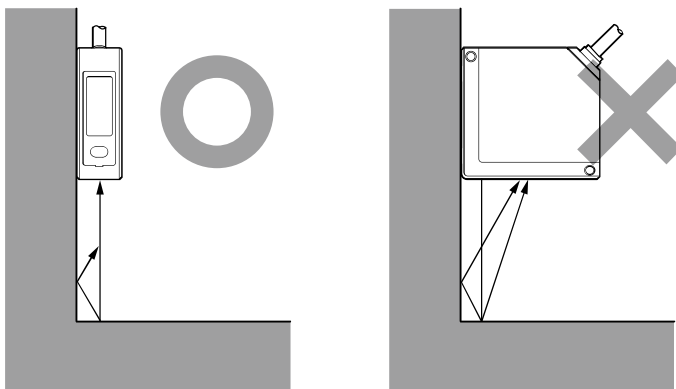

- Measurement of rotating targets

When measuring a rotating target, set the direction of the sensor head as shown below in order to minimize the adverse influence of vertical oscillation or displacement.

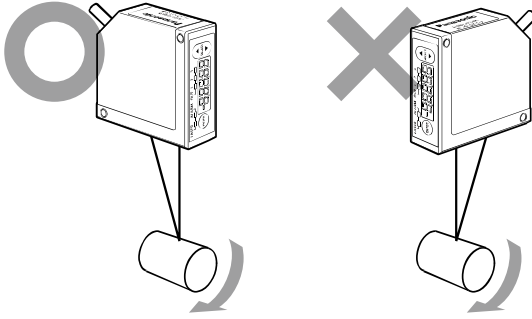

- Measurement of targets with level differences

When measuring a moving target that has level differences, set the direction of the sensor head as shown below in order to minimize interference caused by the edges of the target.

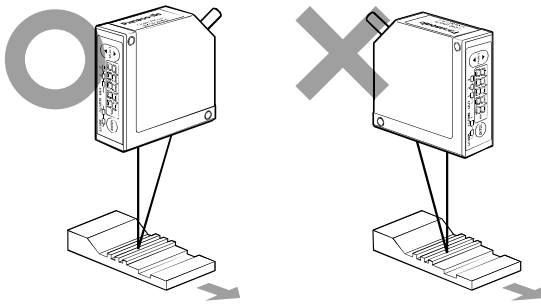

- Measurement of targets in narrow space or slots

When measuring a target in a narrow space or slot, set the direction of the sensor head as shown below in order not to block the light path between the emitter and receiver.

1

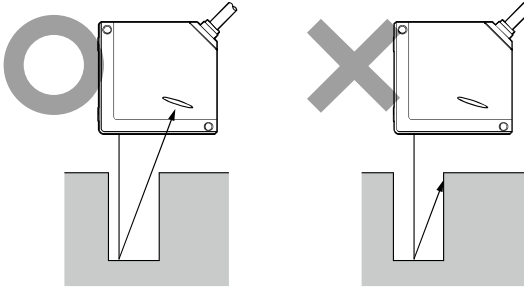

- Sensor head angle to the center of measurement target for a diffuse reflection-type sensor

Mount the sensor head so that the emitter and receiver will be located in parallel to each other as shown in the illustration on the right-hand side.

→ Refer to “6-1 Sensor Head Specifications” for the measurement center distance and measurement range.

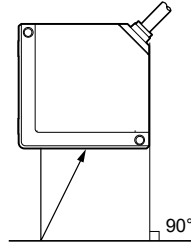

Model name	Measurement center distance	Measurement range
HL-G103-A-C5	30 mm	±4 mm
HL-G103-S-J		
HL-G105-A-C5	50 mm	±10 mm
HL-G105-S-J		
HL-G108-A-C5	85 mm	±20 mm
HL-G108-S-J		
HL-G112-A-C5	120 mm	±60 mm
HL-G112-S-J		
HL-G125-A-C5	250 mm	±150 mm
HL-G125-S-J		

- Sensor head angle to the center of measurement target for a specular reflection-type sensor

Attach so that the receiver will receive light reflected directly as shown in the figure to the right.

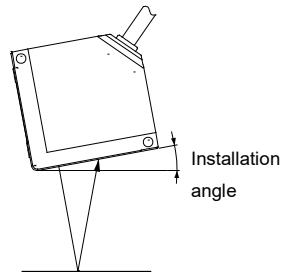

Model name	Measurement center distance	Measurement range	Installation angle
HL-G103A-RA-C5	26.3 mm	±2 mm	15°
HL-G103A-RS-J			
HL-G105A-RA-C5	47.3 mm	±5 mm	10.39°
HL-G105A-RS-J			
HL-G108A-RA-C5	82.9 mm	±10 mm	7.53°
HL-G108A-RS-J			

1-4 Measurement of transparent objects

1

Because the measured value for the closest reflected wave will be output from the sensor when an HL-G1 series specular reflection-type unit measures a multi-reflecting reflector such as transparent glass, only surface measurement is possible.

To accurately measure the surface of a transparent object, it is necessary to separate the reflected wave from the front surface and the reflected wave from the back surface.

The following chart summarizes the thicknesses of glass that can be measured.

Model name	HL-G103A-R□	HL-G105A-R□	HL-G108A-R□
Measurable glass thickness (index of refraction of 1.55)	0.7 mm or more	2.0 mm or more	4.0 mm or more

2

I/O Terminal Block

This chapter provides information on the I/O lines of the sensor head.

2-1 Functions and Arrangements of I/O Terminal Block	2-2
2-2 I/O Circuit	2-4
2-3 Analog Output Circuit	2-6
2-4 Timing Chart	2-7
2-5 Conditions When Output Data Become Unfixed	2-9

2-1 Functions and Arrangements of I/O Terminal Block

Analog Output Lines

No.	Name	Function	Wiring color	
7	A(V)	Analog voltage output	Shield single conductor	Black
8	AGND	Analog ground		
9	A(I)	Analog current output	Shield single conductor	Gray
10	AGND	Analog ground		

2

I/O Terminal Block

No.	Name	Function	Wiring color	
1	OUT1	Judgment output 1	Black	
2	OUT2	Judgment output 2	White	
3	OUT3	Judgment output 3 or alarm output	Gray	
4	TM	Timing input	Pink	
5	MI	Multi-input Zero-set ON, Zero-set OFF, Reset, Memory change, Teaching, Save, and Laser Control inputs	Violet	
6	NP	NPN/PNP type switching input	Pink/Violet	
11	+SD	Transmission data	Twisted-pair wire	Green
12	-SD	Transmission data		Sky Blue
13	+RD	Reception data	Twisted-pair wire	Orange
14	-RD	Reception data		Yellow
15	SG	Signal ground	Shield	
16	+V	24 VDC input for power supply	Brown	
17	0V	Power supply ground	Blue	

❗ CHECK

Line colors on a label for connection included in sensor head produced before December 2010 describes line colors before this modification. Therefore, kindly confirm the following content before use.

Content of Modification

No.	Before changes			→	After
	Name	Function	Wiring color		Wiring color
11	+SD	Transmission data	Twisted-pair wire	→	Green
12	-SD	Transmission data			White
13	+RD	Reception data	Twisted-pair wire	→	Orange
14	-RD	Reception data			White

* Multi-input wire (MI) varies with the period of input as shown below.

Period of input	Function
30 ms	Zero-set ON
80 ms	Reset
130 ms	Memory change (M0)
180 ms	Memory change (M1)
230 ms	Memory change (M2)
280 ms	Memory change (M3)
330 ms	Teaching a (Determines displacement judgment value a)
380 ms	Teaching b (Determines displacement judgment value b)
430 ms	Zero-set OFF (Cancel)
480 ms	Save
530 ms	Laser ON
580 ms	Laser OFF

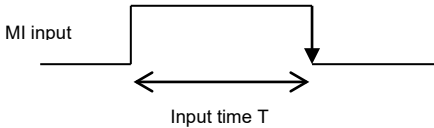

Enter MI input for the desired period with a tolerance of ± 10 ms ($T \pm 10$ ms).

Two or more MI inputs can be entered in sequence on the condition that a minimum interval of 10 ms is set between adjacent MI inputs.

❗ CHECK

- No SD/RD lines are prepared for HL-G1□□-A-C5 standard types.
- The action of NP switching input is determined by the input state of the sensor head with the power turned ON.
- The sensor head does not save setting changes made over the multi-input line. Save the settings over the multi-input line, through the panel, with the communications command, or with the operation of the console if the settings need to be maintained after the system is turned OFF.

2-2 I/O Circuit

- When using with NPN output (Connect NP switching input to 0V)

2

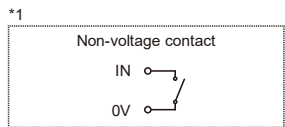
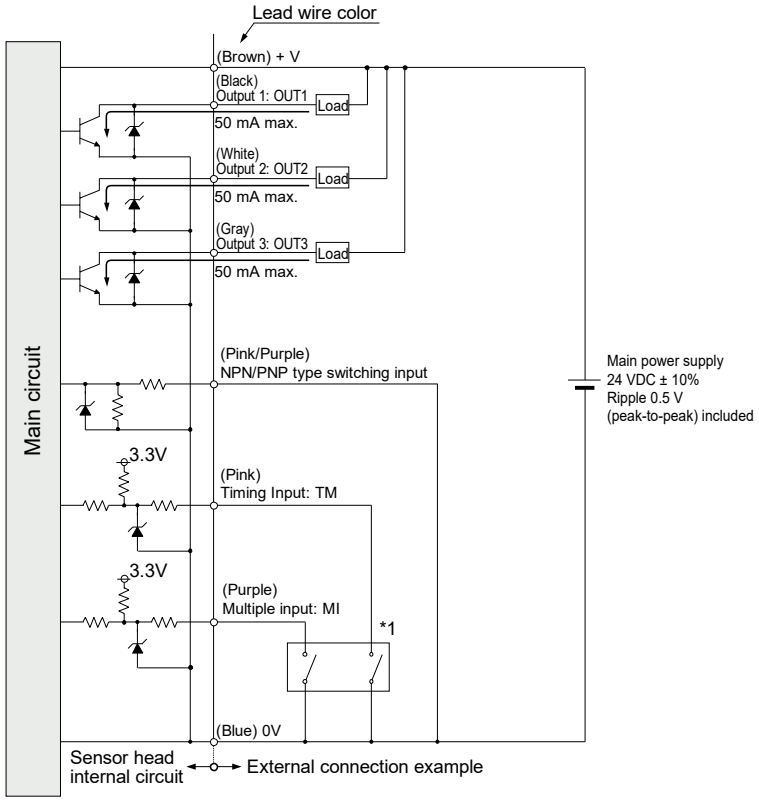

■ When using with PNP output (Connect NP switching input to +V)

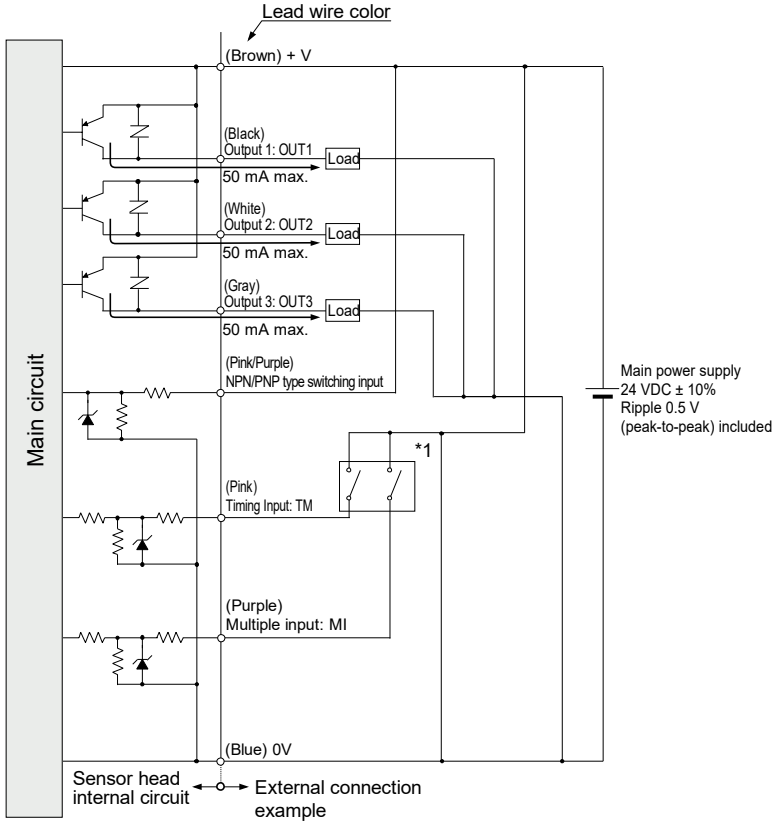

2

*1

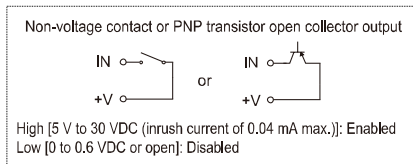

2-4 Timing Chart

- NORMAL measurement (with timing mode set to “Hold”)

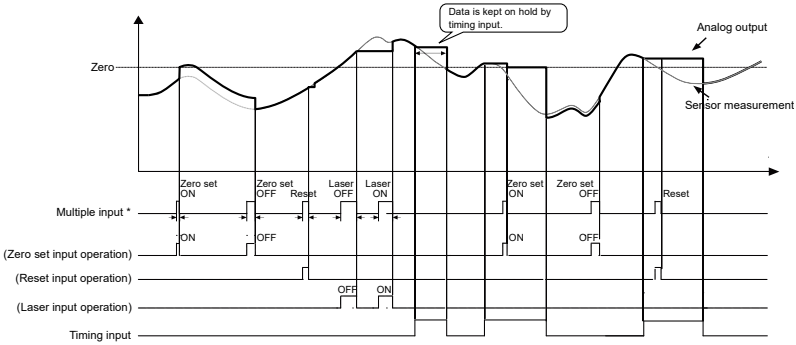

- NORMAL measurement (with timing mode set to “One-shot”)

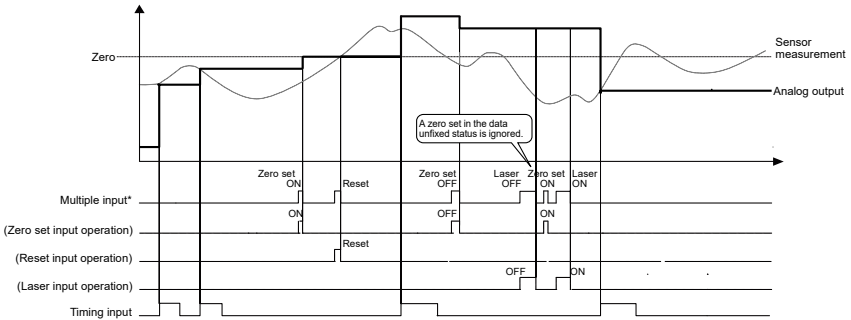

- PEAK measurement

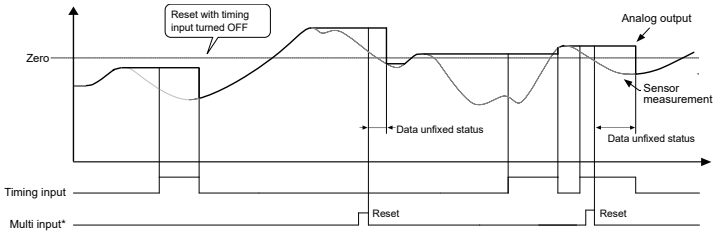

* The function of multiple input varies with the period of input.

Zero set ON: 30ms Zero set OFF: 430 ms Reset: 80 ms

Laser ON: 530 ms Laser OFF: 580 ms

- A zero set will be enabled by timing input while the HOLD status is valid.
- A reset input by timing input during the HOLD status will cause a data unfixed status. The system will hold this status until the timing input is cancelled.
- No zero set will be enabled while the data unfixed status is kept on hold.
- The system will hold reset input while the data unfixed status is valid until the timing input is cancelled.
- Judgment output is determined by the measured value and “displacement judgment”. The output will become LO judgment while the data unfixed status is valid.
- When any data unfixed status other than that caused by reset input is valid, the console displayed value, analog output, and judgment output will become the same in performance.
- Analog output during the data unfixed status is indicated by the initial setting.
- If the system has been set to “Offset”, the offset value will be added when a zero set is executed.
- If a zero set is executed during PEAK to PEAK measurement, the present measurement value will become zero (i.e., the reference value of measurement). Therefore, the measurement value will start from a negative (-) value if the system is reset while a zero set is executed.
- If “digital output at alarm” is fixed, the judgment output of the sensor head will be interlocked with the fixed value.

Processing of zero set/timing/reset inputs

	On timing input	Reset input (during data unfixed time)
Zero set input (ON/OFF)	Reflected at the time of zero set input (on console displayed value and analog output).	Invalid
Timing input		The data unfixed status is kept on hold.
Reset input	A data unfixed status will occur at the time of reset input (HOLD status while timing input is ON).	

Function of timing input (level)

Analysis mode	Function
NORMAL measurement	The measurement value will be kept on hold with timing input turned ON in this mode, and the hold status will be canceled with the timing input turned OFF.
PEAK measurement VALLEY measurement	The measurement value will be kept on hold at the moment the input signal turned ON in this mode, and the hold status will be canceled with the input signal turned OFF. The peak (bottom) value will be reset when the HOLD status is cancelled.
PEAK to PEAK measurement	The measurement value will be kept on hold at the moment the input signal is turned ON in this mode, and the hold status will be canceled with the input signal turned OFF. The data will be set to zero when the HOLD status is cancelled.

2-5 Conditions When Output Data Become Unfixed

The operation status will be judged as a data unfixed status (i.e., there is no determined data) immediately after settings changes are made, the system is reset, or laser stop input is turned ON. This status is not an alarm status.

The data unfixed status starts at the time of restarting measurement after setting refreshment or resetting until the number of data measurement times reaches an average. Under the data unfixed status, a digital output of -999.9999 [mm] and an analog output of 11.000 [V] or 21.6 [mA]*1 will be turned ON.

- *1 This is the initial value. Under the data unfixed status, the analog output of the system can be changed to a fixed value. For more information, → refer to “3-3-7 Alarm Settings” – “Analog Output at Alarm”.
- *2 Under the data unfixed status, the zero set input will be ignored.
- *3 For cancelling the data unfixed status, → refer to Chapter 5 “Troubleshooting”.

For example, the graph on the right-hand side shows the digital display at reset input for NORMAL measurement.

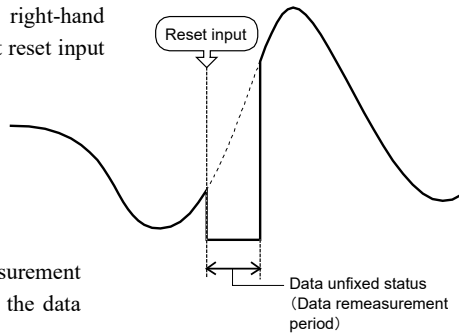

The table below shows the measurement value display and output under the data unfixed status or alarm status.

	Data unfixed status	Alarm status
Status	Measurement data is unfixed. (Average buffer has not reached the setting number of times.)	Measurement disabled status due to poor light intensity or when the target object is off the measurement range.
Measurement Value Display	「—————」	The previous value (default) is kept on hold.
Analog output	The previous value (default) is kept on hold.	The previous value (default) is kept on hold.
Digital output (High function type only)	-999.9999 [mm]	The previous value (default) is kept on hold.
Judgment Output	LO judgment	Interlocks with digital output
Alarm output	Interlocks with alarm status	ON

The following conditions will result in the data unfixed status.

- Reset input after the power is turned ON
- Sampling cycle switching
- Initialization
- Laser control interruption
- Average times switching

* There are cases where the data unfixed status does not occur depending on the setting conditions.

3







Functions

This Chapter provides information on the functions of the system.

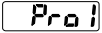
3-1	Classification of Functions	3-2
3-2	Function List & Initial Values	3-2
3-3	Operation of Each Function	3-5
3-3-1	Basic Operation	3-5
3-3-2	Memory Change	3-11
3-3-3	Sensing Setting	3-13
3-3-4	Data Processing Settings	3-16
3-3-5	Output Settings	3-23
3-3-6	Analog Settings	3-30
3-3-7	Alarm Settings	3-33
3-3-8	COM Settings	3-36
3-3-9	System Settings	3-41
3-3-10	Other System Settings	3-45
3-3-11	Measurement Control with External Input	3-47
3-3-12	Buffering Settings (High-function type only)	3-50

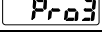
3-1 Classification of Functions

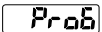
In this system, all functions are classified into eight categories to ensure stable measurement and various outputs.

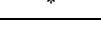
Classification	Panel display	Function
Sensing Settings		Function settings for precise and stable measurement by controlling the received light intensity of the sensor.
Data Processing Settings		Function settings for processing measurement values.
Output Settings		Function settings related to output data processing.
Analog Settings		Function settings related to analog output processing.
Alarm Settings		Function settings related to alarm output processing.
COM Settings		Function settings related to communication.
System Settings		System settings such as "Initialization," "Save," and communications settings.
Buffering Settings	*	Function settings related to buffering.

* This function is available to high-function type serial communication for which no panel settings are possible.

3-2 Function List & Initial Values

Class	Function	Details	Initial value	Memory change*	Ref. page
	Memory Change	Changes memory for saving the setting contents.	Default: M0	☆	3-11
Sensing settings	Sampling Cycle	Sets the sampling cycle for measurement.	Default: 500 μ s	○	3-13
	Shutter Time	Controls the receiving light intensity of the sensor according to the amount of reflected light from measurement targets.	Default: Auto	○	3-14
	Light Intensity Monitor	Checks the current received light intensity.		-	3-15
Data Processing Settings	Average Times	Sets the average number of times of moving average.	Default: 1024	○	3-16
	Analysis Mode	Sets the analysis mode.	Default: Normal measurement	○	3-17
	Span	Sets the measurement coefficient.	Default: 1.0000	○	3-19
	Offset	Sets the measurement offset.	Default: 00000 mm	○	3-21
	Zero-set OFF	To release the zero-set state.	Default: OFF	○	3-22

Class	Function	Details	Initial value	Memory change*	Ref. page
Output Settings	Judgment Output Selection	Sets the operation of the output block. Default: 2-state		○	3-23
	Displacement Judgment	Threshold a	Sets threshold a and threshold b. Default: +(detection range) Default: -(detection range)	○	3-25
		Threshold b		○	
		Hysteresis	Sets the hysteresis. Default: +(0.2% of setting range)	○	
		Judgment Output OFF Delay	Delays the timing of judgment output switched OFF from ON. Default: OFF	○	3-27
	Measurement Value Display on Panel	Turns OFF the rightmost digits on the digital display. Default: SET 1	○	3-29	
Analog Settings	Analog Output Selection	Selects the desired output type from current output and voltage output. Default: Current output		○	3-30
	Analog Scaling	Meas A	Performs scaling the analog current output and the analog voltage output to any desired value.	○	3-31
		Meas B		○	
		Current a		○	
		Current b		○	
		Voltage a		○	
		Voltage b		○	
Alarm Settings	Analog Output at Alarm	Sets the analog output status at alarm operation. Default: Holds previous value		○	3-33
	Digital Output at Alarm	Sets the digital output status at alarm operation. Default: Holds previous value		○	3-34
	Alarm Delay Times	Holds the previous normal value up to the setting number of times if an alarm is issued. Default: 8 times		○	3-35
COM Settings	Terminating Resistor Selection	Selects the terminating resistor for the sensor head connecting to the host device over RS-422/485. Default: R3		☆	3-36
	Sensor no.	Sets the number of each sensor head multi connected to an RS-485 device. Default: 01		☆	3-37
	Baud rate	Sets the communication speed. Default: 38400 bps		☆	3-38
	Connection Mode	Selects the performance settings for measurement data output to the host device. Default: RS-485 Multiple		☆	3-39
	Sending Delay Time	Set the sensor's delay time in response to each command transmitted from the host device. Default: 0ms		☆	3-40
System Settings	Timing Mode	Sets the timing input mode. Default: Hold		☆	3-41
	Laser Control	Switches laser emission/stop. Default: Emission		☆	3-42
	Eco Mode	Turns OFF the LED indicators on the control panel for energy saving while the system is in RUN mode. Default: Eco OFF		☆	3-43
	View Version	Displays the program version of the sensor.		-	3-44
Others	Initialization	Initializes the memory settings currently in use.		×	3-45
	Save	Saves all memory settings.		×	3-46

Class	Function	Details	Initial value	Memory change*	Ref. page
External input operation	Timing	Holds the measurement value.	Default: OFF	-	3-47
	Zero-set	Sets the measurement value to zero.		-	3-47
	Reset	Resets the measurement value.	Default: OFF	-	3-49
Buffering Settings	Buffering Mode	Sets the buffering mode.	Default: Continuous mode	☆	3-52
	Buffering Rate	Loads measurement data for a long duration by decimating the measurement data during data accumulation.	Default: 1/10	☆	3-53
	Accumulated Amount	Sets the amount of accumulated data.	Default: 3000 data items	☆	3-53
	Trigger Point	Sets the trigger generation position in the accumulated data.	Default: 300	☆	3-54
	Trigger Delay	Delays the timing of accumulation after the trigger generation.	Default: 0	☆	3-54
	Trigger Conditions	Sets the conditions of trigger generation.	Default: At timing input ON	☆	3-55
	Buffering Operation	Starts buffering with buffering-related parameters set in advance.		☆	3-56
	Status Readout	Checks the operation status of accumulation.		-	3-56
	Last Data Point	Reads out the accumulation status from the amount of measurement data.		-	3-56
	Binary Readout of Buffering Data	Reads out the accumulated data.		-	3-57

- * Memory change ○: Up to four types of settings can be saved by performing memory change.
- ×: Settings cannot be changed by performing memory change.
- ☆: Settings are saved as common settings for all memories. Settings cannot be executed on a memory-to-memory basis.

① CHECK

- COM settings and buffering settings are functions dedicated to the high-function type. These settings are not used for the standard type.
- Buffering settings cannot be made through the control panel. Make settings with serial communications commands.
- Each set value is saved in either one of the following ways depending on the operating method selected.

<Control panel of sensor head>

Press the [ENTER] key to save after a set value change is made.

<Serial communications command (High-function type only)>

Execute the “Save” command after making a setting change.

The execution of the “Save” command is required after making a setting change in the case of using the Setting and Monitoring Software HL-G1SMI for the dedicated console (sold separately).

3-3 Operation of Each Function

3-3-1 Basic Operation

■ Panel Configuration

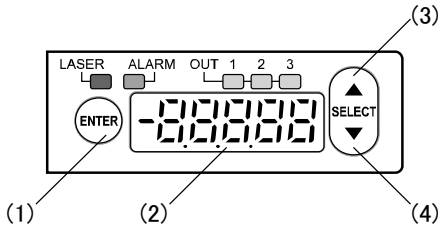

(1) [ENTER] Key

Used to enter items.

(2) Digital Display

Displays measurement values, set values, and system errors.

(3) [UP] Key

Used to select items.

(4) [DOWN] Key

Used to select items.

Digital Display

The decimal point position varies with each model.

Measurement value and set value

HL-G103-□

HL-G105-□/HL-G108-□/HL-G112-□

HL-G125-□

Data unfixed status

Alarm status with the “digital output at alarm” set to a fixed value.

HL-G103-□

HL-G105-□/HL-G108-□/HL-G112-□

HL-G125-□

■ Basic Operation

The following section explains how to operate the system in RUN mode after the system is turned ON, make function changes in the system, and reset the system to RUN mode, along with the shortcut functions of the system in RUN mode.

The operation of the system common to each function is explained below. For more information on settings peculiar to the respective functions, → refer to "3-3-2 Memory Change" through "3-3-9 System Settings."

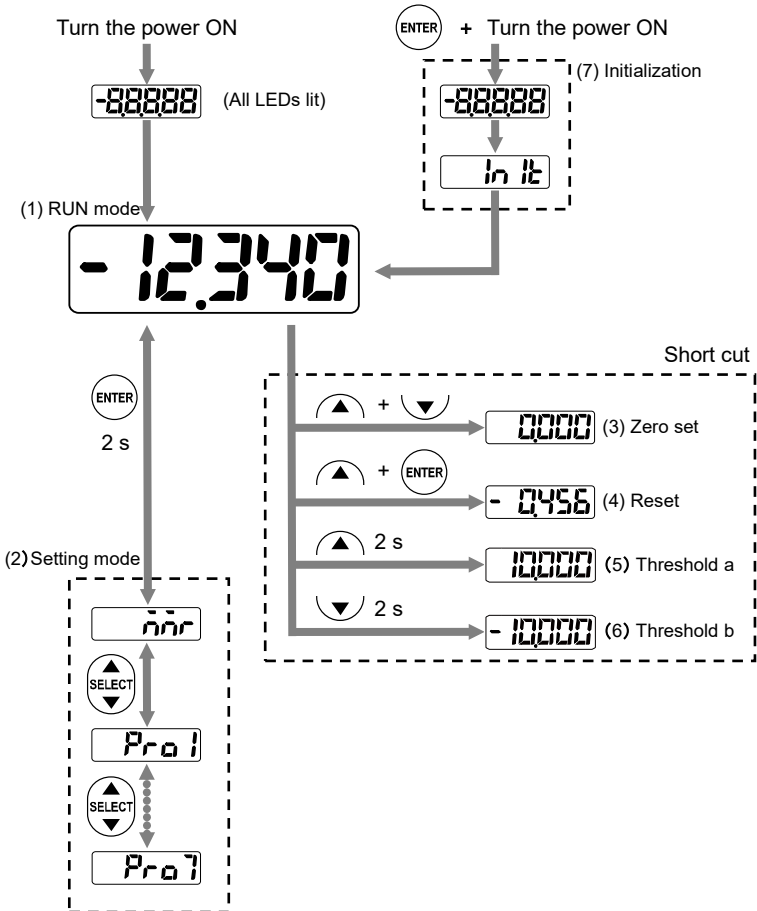

(1) RUN mode

The measurement value will appear on the digital display in this mode.

The system will be set to this mode when the system is turned ON.

RS-422/485 write and read commands will be received while the system is in this mode.

(2) Setting mode

Use this mode to make setting changes.

RS-422/485 write commands cannot be received while the system is in this mode.

An error code indicating that the system is in setting mode will be returned if a write command is received.

Refer to the next page for the transition of the screen while the system is in setting mode.

(3) Zero set

The measurement value will be set to zero in this mode.

(4) Reset

The measured value kept on hold by the system in measurement mode will be reset.

(5) Threshold a

The screen will change to the threshold-a setting screen.

(6) Threshold b

The screen will change to the threshold-b setting screen.

(7) Initialization

Initialization deletes all settings and returns them to the factory default settings.

 **Supplemental remarks**

Setting changes in the control panel of the sensor head will be saved in the internal memory.

- Making Setting Value Changes

"Span," "Offset," "Displacement judgment," "Analog scaling," "Number of alarm delay times" setting values can be changed freely.

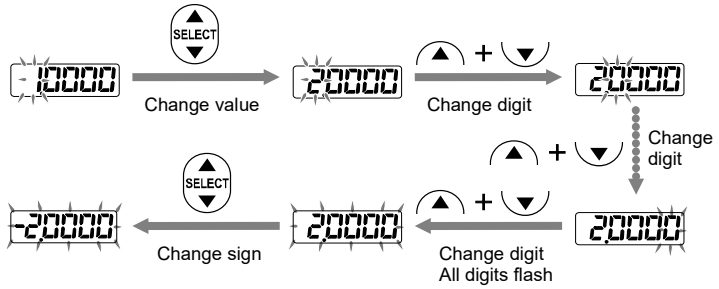

■ Screen Transition in Setting Mode

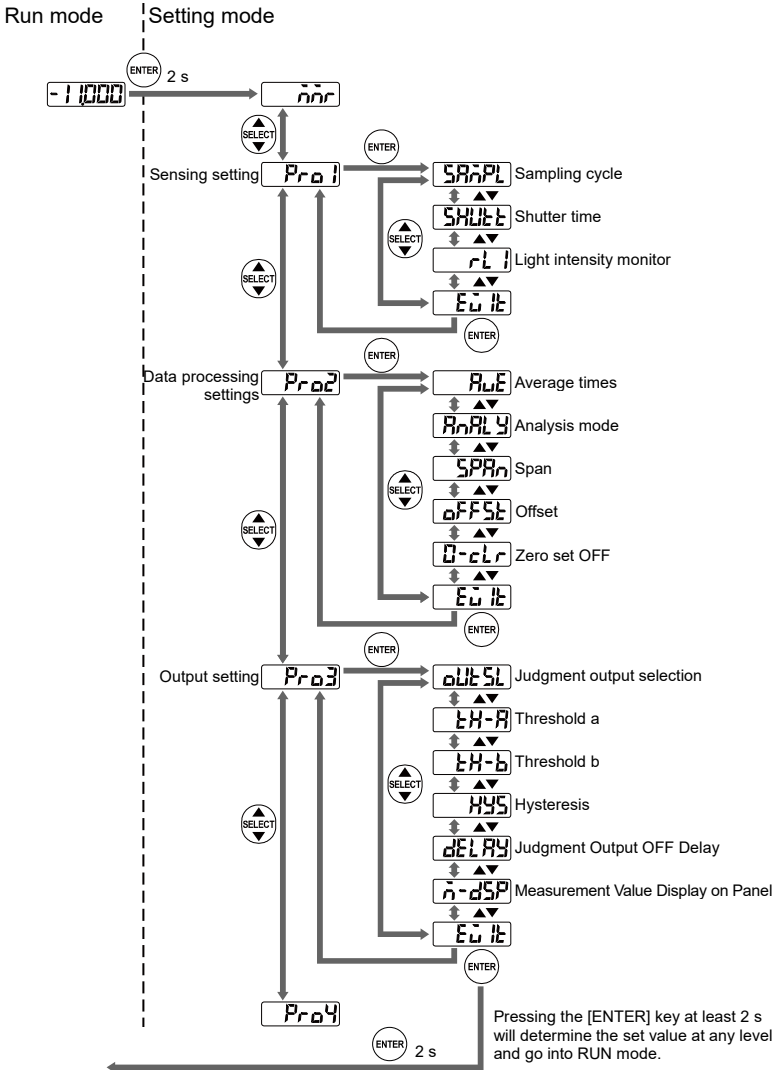

3

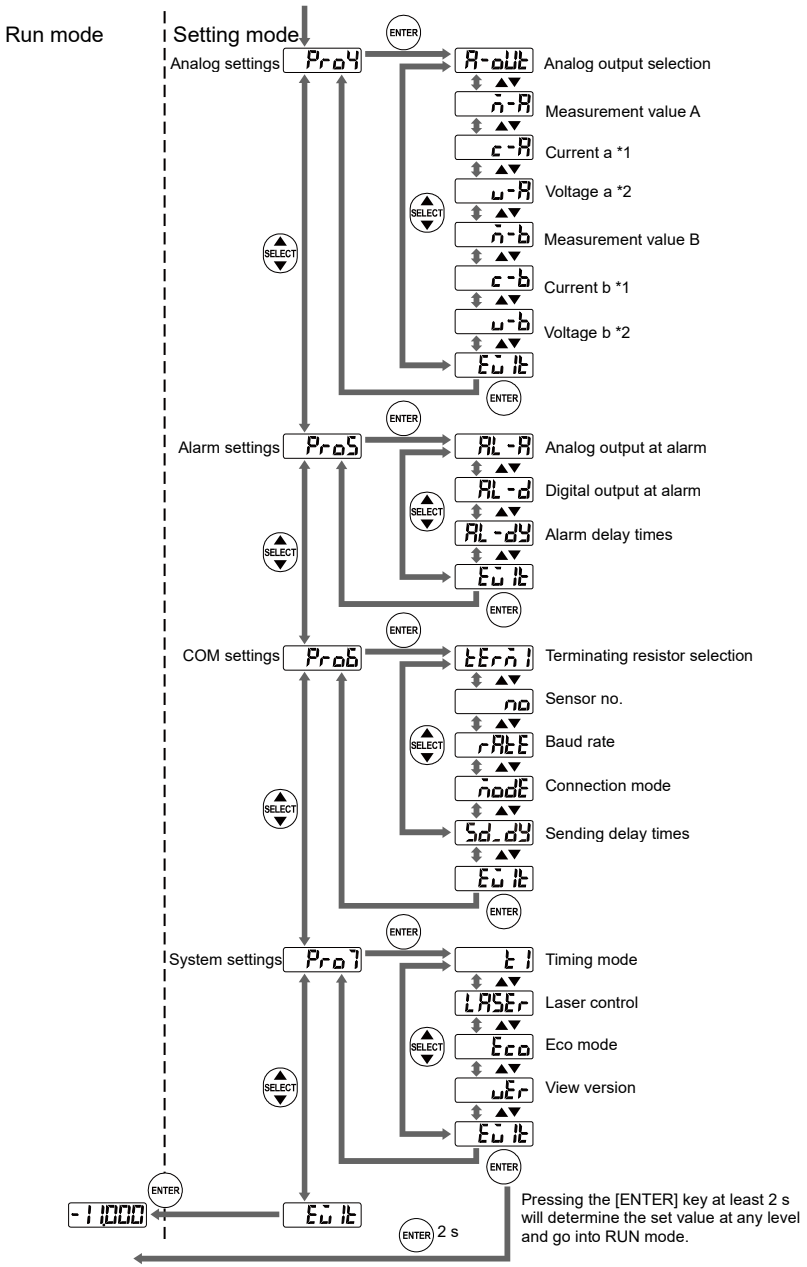

*1 Not displayed when "Voltage" is selected for "Analog Output Selection."

*2 Not displayed when "Current" is selected for "Analog Output Selection."

3-3-2 Memory Change

The memory to save setting contents can be changed with M0 through M3.







Setting	Function	Panel display
M0	Memory M0	
M1	Memory M1	
M2	Memory M2	
M3	Memory M3	

*  indicates the default value.

① CHECK

- Select the first number to be changed when the system goes into setting mode.
- Data instability may result when the memory change is executed.
- If setting changes are made with a serial communications command, save the changes so that the changes will be reflected when the system is turned ON again.

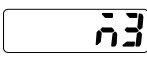
• Setting Procedure

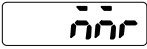
- 1 Display the "Memory Change" screen while the system is in setting mode. 
- 2 Press the [ENTER] key. The memory will be displayed.  
- 3 Press the [UP]/[DOWN] key to make memory changes. (Example: Changing the memory to "M3".)  
- 4 Press the [ENTER] key to determine the memory.  

• Memory Saving Settings

Each function that has been set can be saved in four ways in the memory area in the sensor head.

Measurement and judgment conditions can be saved individually according to the type of measurement object. Therefore, memory number changes will be possible without entering the set values for a wide variety of functions.

Memory changes are made with external commands and settings in the control panel.

Storable Functions in Memory

The function settings that can be stored in the memory are divided into two types. One of them can be stored in each specified memory number and the other one can be stored as setting values common to all memories.

For the above two types of storable functions in detail, → refer to "3-2 Function List & Initial Values".

3-3-3 Sensing Setting



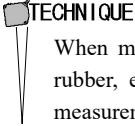

Pro 1

■ Sampling Cycle

This function is used to make measurement cycle settings.











When measuring an object with poor received light intensity, such as black rubber, extend the sampling cycle to get sufficient light to perform stable measurement.

Cycle	Frequency	Panel display	Meas. object
200 μ s	5 kHz		
500 μ s	2 kHz		
1 ms	1 kHz		
2 ms	500 Hz		

*1 The measurement range may become narrow depending on measurement object type.

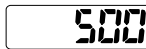
*2  indicates the default value.

● Setting Procedure

- 1 Display the "Sensing Setting" screen while the system is in setting mode. 
- 2 Press the [ENTER] key. The "Sampling Cycle" screen will be displayed.  
- 3 Press the [ENTER] key. The present sampling cycle will be displayed.  
- 4 Press the [UP]/[DOWN] key to make sampling cycle changes. (Example: Changing the sampling cycle to 1 ms.)  
- 5 Press the [ENTER] key to determine the sampling cycle.  

3











■ Shutter Time

The shutter time controls the receiving light intensity of the sensor according to the amount of reflected light from measurement targets.

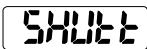
If the shutter time is set to AUTO, the light intensity feedback function automatically controls the light intensity to an optimum level. In the case of fixing the shutter time, use the light intensity monitor and select a fixed value of approximately 1000 to 1300.

Setting	Function	Initial value
AUTO	Shutter time automatic setting	
1 to 31	Fixed (See the table below.)	

● Setting Procedure

- 1 Display the "Sensing Setting" screen while the system is in setting mode. 
- 2 Press the [ENTER] key. The "Sampling Cycle" screen will appear.  
- 3 Press the [DOWN] key once. The "Shutter Time" screen will be displayed.  
- 4 Press the [ENTER] key. The present shutter time will be displayed.  
- 5 Press the [UP]/[DOWN] key to make shutter time changes. (Example: Changing the shutter time to 31.)  
- 6 Press the [ENTER] key and determine the shutter time.  

The following table shows the relation between the set values for shutter time and actual shutter apertures.







Set value	Shutter aperture	Set value	Shutter aperture	Set value	Shutter aperture	Set value	Shutter aperture
AUTO	Auto	8	0.24%	16	1.95%	24	15.9%
1	0.04%	9	0.31%	17	2.54%	25	20.7%
2	0.05%	10	0.40%	18	3.30%	26	26.9%
3	0.06%	11	0.53%	19	4.29%	27	35.0%
4	0.08%	12	0.68%	20	5.58%	28	45.5%
5	0.11%	13	0.89%	21	7.25%	29	59.2%
6	0.14%	14	1.16%	22	9.43%	30	76.9%
7	0.18%	15	1.50%	23	12.3%	31	100%

■ Light Intensity Monitor

This function is used to check the current received light intensity.

The peak light intensity will be displayed in a range of 0 to 4095.

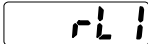
● Setting Procedure

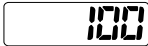
- 1 Display the "Sensing Setting" screen while the system is in setting mode. 
- 2 Press the [ENTER] key. The "Sampling Cycle" screen will appear.  
- 3 Press the [DOWN] key twice. The "Meas Suf Selection" screen will be displayed.  
- 4 Press the [ENTER] key. The present light intensity will be displayed.  

3

3-3-4 Data Processing Settings

Prod

■ Average Times Ave

This function is used to set the average number of times of moving average. Use the function to stabilize unstable measurement values (including variations).





Setting	Function	Panel display
1 time	1-time moving average processing	1
4 times	4-time moving average processing	4
16 times	16-time moving average processing	16
64 times	64-time moving average processing	64
256 times	256-time moving average processing	256
1024 times	1024-time moving average processing	1024

* indicates the default value.

❗ CHECK

Data instability may result until the movement average buffer reaches the setting number of times. When the data becomes unstable, the analog output, digital output and judgment output will change. (→ refer to "2-5 Conditions When Output Data Become Unfixed"). If there is an alarm when the moving average buffer is cleared, moving averaging will start after the alarm state is cleared. Moving averaging based on the previous data will be performed if an alarm occurs until the setting number of times is reached after moving averaging starts.

● Setting Procedure

- 1 Display the "Data Processing Setting" screen while the system is in setting mode. Prod
- 2 Press the [ENTER] key. The "Average Times" screen will be displayed.
 Ave
- 3 Press the [ENTER] key. The present number of average times will be displayed.
 1024
- 4 Press the [UP]/[DOWN] key to change the number of average times. (Example: Changing the number of average times to 256.)
 256
- 5 Press the [ENTER] key and determine the number of average times.
 Ave

■ Analysis Mode ANALY

This function is used to set the analysis mode.

The following table shows the function of each analysis mode.

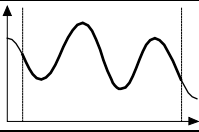
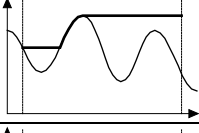
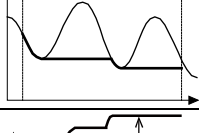
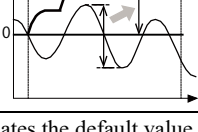
Setting	Function	Panel display
NORMAL	 The measurement value is output in real time.	norm
PEAK	 Holds and outputs the maximum measurement value.	PEAK
VALLEY	 Holds and outputs the minimum measurement value.	VALLY
PEAK to PEAK (P-P)	 Holds and outputs the difference between the maximum and minimum values.	P-2-P

* indicates the default value.

TECHNIQUE

Peak to Peak can be used for vibration or eccentricity measurement.

● Setting Procedure

- 1 Display the "Data Processing Setting" screen while the system is in setting mode. Proc
- 2 Press the [ENTER] key. The "Average Time" screen will be displayed. ENTER AVE
- 3 Press the [DOWN] key once. The "Analysis Mode" screen will be displayed. SELECT ANALY
- 4 Press the [ENTER] key. The present analysis mode will be displayed. ENTER norm

- 5 Press the [UP]/[DOWN] key to make analysis mode changes. (Example: Switching to PEAK to PEAK mode.)

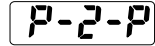

- 6 Press the [ENTER] key to determine the mode setting.



Span

The system can output measurement values with a span (factor) multiplied.

Final measurement value = Span x measurement value + offset

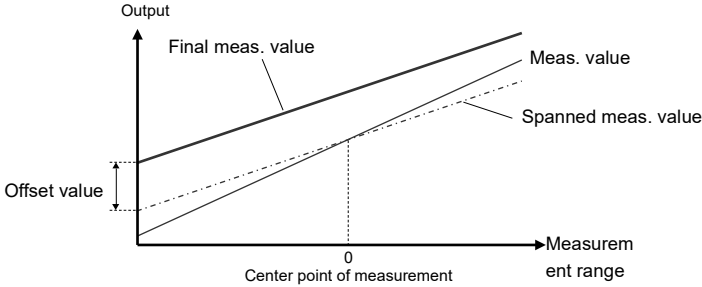









Setting range	Function	Initial value
0.1000 to +9.9999	Set a span in a range from 0.1000 to +9.9999.	

! CHECK

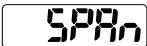
The display limit of the measurement value is $\pm 95,000$. Make sure that the setting value does not exceed the display limit.

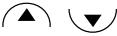
• Setting Procedure

- 1 Display the "Data Processing Setting" screen while the system is in setting mode. 
- 2 Press the [ENTER] key. The "Average Time" screen will be displayed.  
- 3 Press the [DOWN] key twice. The "Span" screen will be displayed.  
- 4 Press the [ENTER] key. The present span will be displayed. The leftmost digit will be selected.  
- 5 Press the [UP]/[DOWN] keys together to change the selected digit. After all the changed digits have blinked the sign can be changed. For details, refer to page 3-8 "Making Setting Value Changes."  

- 6** Press the [UP]/[DOWN] key to change the value of the selected digit. (Example: Changing the value to 2.0000.)



- 7** Press the [ENTER] key to determine the span.



■ Offset OFFSt

A desired setting value can be added to/subtracted from the measurement value.

TECHNIQUE

Measurement judgment will be possible from an offset in combination with “displacement judgment” by setting the size of the master workpiece (reference measurement object) for the offset, measuring the master workpiece, and turning the “zero set” ON.

Setting range	Function	Initial value
-95000 to +95000	Set an offset in a range from -95000 to +95000. (The decimal point position varies with each model.)	00000

① CHECK



- Set "Offset" and turn "Zero Set" ON to make the setting value an offset value.
- The display limit of the measurement value is ± 95000 . Make sure that the setting value does not exceed the display limit.

● Setting Procedure

- 1 Display the "Data Processing Setting" screen while the system is in setting mode. PrOd
- 2 Press the [ENTER] key. The "Average Time" screen will be displayed. ENTER Ave
- 3 Press the [DOWN] key three times. The "Offset" screen will be displayed. ▲
SELECT
▼ OFFSt
- 4 Press the [ENTER] key. The present offset value will be displayed. The leftmost digit will be selected. ENTER 00000
- 5 Press the [UP]/[DOWN] keys together to change the selected digit. After all the changed digits have blinked the sign can be changed. For details, refer to page 3-8 "Making Setting Value Changes." 0000
- 6 Press the [UP]/[DOWN] key to change the value of the selected digit or its sign. (Example: Changing the value to +2.500 [mm].) ▲
SELECT
▼ 2500
- 7 Press the [ENTER] key and determine the offset value. ENTER OFFSt

■ Zero-set OFF











This function cancels the zero set for measurement values.

Setting	Function	Panel display
Reset	The zero set is not canceled.	
Hold	The zero set is canceled.	

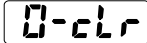
Supplemental remarks

- External multi input (MI) can turn the zero set ON and OFF. (→ refer to "2-1 Functions and Arrangements of I/O Terminal Block.")

● Setting Procedure

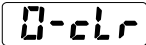
- 1 Display the "Data Processing Setting" screen while the system is in setting mode. 
- 2 Press the [ENTER] key. The "Average Time" screen will be displayed.  
- 3 Press the [DOWN] key four times. The "Zero-set OFF" screen will be displayed.  
- 4 Press the [ENTER] key. "Yes/No" will be displayed.  
- 5 Press the [UP]/[DOWN] key to make "Yes/No" changes. (Example: Maintaining the zero-set state.)  
- 6 Press the [ENTER] key.  

3-3-5 Output Settings

Pro3

■ Judgment Output Selection OUT5L

This function makes it possible to select the operation of the output block.

An alarm will not be output if "3-state" is selected.

The final decision process is done in digital measurements. When an alarm is turned ON, the value will be set to +999.9999 with which judgment processing will be performed, provided that a fixed value has been set with "digital output at alarm".

Judgment Output Selection	Output operation			
	OUT1	OUT2	OUT3	
Logic Logic	Judgment 1	Judgment 2	Alarm	
Independent Ind	Judgment 1	Judgment 2	Alarm	
2-state 2ARL	Judgment 1	Judgment 2	Alarm	
3-state 3ARL	Judgment 1	Judgment 2	Judgment 3	

* indicates the default value.

3

❗ CHECK

OUT3 settings are related to the operation of the output lines. An alarm is output through the OUT3 output line unless a 3-state value has been set. The OUT3 indicator on the sensor head and the OUT3 output readout function, however, will be turned OFF without being interlocked with the alarm. Check the alarm state with the alarm indicator and alarm readout function.

- Setting Procedure

- 1 Display the "Output Setting" screen while the system is in setting mode.

- 2 Press the [ENTER] key. The "Judgment Output Selection" screen will be displayed.



- 3 Press the [ENTER] key. The present output type will be displayed.



- 4 Press the [UP]/[DOWN] key to make output type changes. (Example: Changing the output type to "Independent.")



- 5 Press the [ENTER] key to determine the output type.



■ Displacement Judgment

This function is used to set an upper limit (threshold a), lower limit (threshold b), and hysteresis for the judgment of measurement values.

Item	Panel display	Setting range	Function
Threshold a		-95000 to +95000	Sets threshold a, threshold b and hysteresis.
Threshold b		-95000 to +95000	
Hysteresis		0 to +95000	

Supplemental remarks The following default values apply.

Type	Diffuse reflection			Specular reflection		
	Threshold a	Threshold b	Hysteresis	Threshold a	Threshold b	Hysteresis
30 mm	+4mm	-4mm	8μm	+2mm	-2mm	8μm
50 mm	+10mm	-10mm	20μm	+5mm	-5mm	20μm
85 mm	+20mm	-20mm	40μm	+10mm	-10mm	40μm
120 mm	+60mm	-60mm	120μm	-	-	-
250 mm	+150mm	-150mm	300μm	-	-	-

3

① CHECK

- Set the value so that |Threshold a - Threshold b| is larger than the hysteresis × 2.
- The decimal point position varies with each model.

TECHNIQUE

Pressing [▲] for at least 2 seconds will set Threshold a. Also, pressing [▼] for at least 2 seconds will set Threshold b.

● Setting Procedure (Setting Threshold a)

- 1 Display the "Output Setting" screen while the system is in setting mode.
- 2 Press the [ENTER] key. The "Judgment Output Selection" screen will be displayed.
- 3 Press the [DOWN] key once. The "Threshold a" screen will be displayed.
- 4 Press the [ENTER] key. The present threshold will be displayed. The leftmost digit will be selected.

- 5 Press the [UP]/[DOWN] keys together to change the selected digit. After all the changed digits have blinked the sign can be changed. For details, refer to page 3-8 "Making Setting Value Changes."



- 6 Press the [UP]/[DOWN] key to change the selected digit or its sign. (Example: Changing the value to +5 [mm].)



- 7 Press the [ENTER] key to determine the threshold.

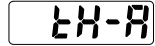

■ Judgment Output OFF Delay DELAY

This function delays the timing of switching ON to OFF of judgment output.

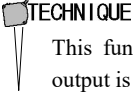

This function is useful for applying output to a control device when the output is changing at high speed.

Setting	Function	Panel display
OFF	Output according to the sampling cycle.	OFF
2 ms	2-ms OFF-delay	2ms
4 ms	4-ms OFF-delay	4ms
10 ms	10-ms OFF-delay	10ms
20 ms	20-ms OFF-delay	20ms
40 ms	40-ms OFF-delay	40ms
100 ms	100-ms OFF-delay	100ms
Hold	Output once turned ON will be kept on hold. The output kept on hold will be released with reset input.	Hold

* indicates the default value.

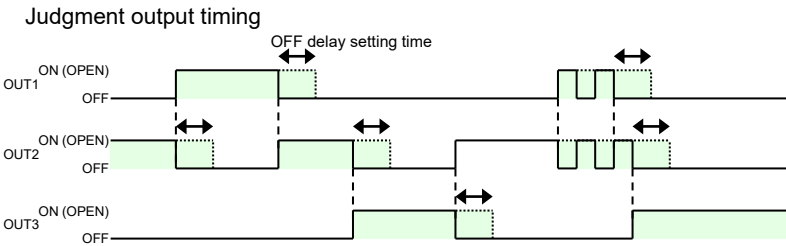









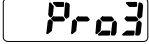

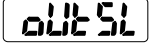
The solid lines shows OFF setting actions. OFF timing will be delayed according to the OFF-delay set time as shown by the dotted lines.

❶ CHECK

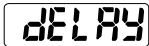

- If actual output is turned ON earlier than the OFF-delay set time, the OFF-delay set time will be enabled from the point where the output is turned OFF.
- If "Logic" or "Independent" or "2-state" is selected with the judgment output selection function, OUT3 (alarm output) will not be OFF-delayed regardless of OFF-delay settings.
- The output indicator will not be OFF-delayed.

- Setting Procedure

- 1 Display the "Output Setting" screen while the system is in setting mode. 
- 2 Press the [ENTER] key. The "Judgment Output Selection" screen will be displayed.  
- 3 Press the [DOWN] key four times. The "OFF-delay" screen will be displayed.  
- 4 Press the [ENTER] key. OFF-delay settings will be displayed.  
- 5 Press the [UP]/[DOWN] key to make OFF-delay setting changes. (Example: Changing the setting to Hold.)  
- 6 Press the [ENTER] key to determine the OFF-delay setting.  









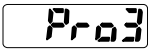

■ Measurement Value Display on Panel

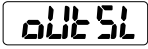
The rightmost digits on the digital display can be turned OFF.

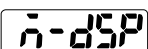
Setting	Function	Panel Display
FULL	All the digits are displayed.	
Set 1	The rightmost digit is OFF.	
Set 2	The rightmost two digits are OFF.	

*  indicates the default value.

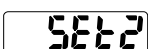
● Setting Procedure

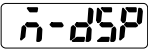
- 1 Display the "Output Setting" screen while the system is in setting mode. 
- 2 Press the [ENTER] key. The "Judgment Output Selection" screen will be displayed.  
- 3 Press the [DOWN] key five times. The "Measurement Value Display on Panel" screen will be displayed.  
- 4 Press the [ENTER] key. The "Measurement Value Display on Panel" screen will be displayed.  
- 5 Press the [UP]/[DOWN] key to make a setting change for the measurement value display on the panel. (Example: Changing the present setting to Set 2.)  
- 6 Press the [ENTER] key to determine the setting for the measurement value display on the panel.  

● Set2 usage example

In this example "FULL" is changed to "Set2."



3-3-6 Analog Settings

■ Analog Output Selection

This function selects the desired output type from current output and voltage output.

The accuracy of selected analog output will be guaranteed.

Setting	Function	Panel display
Current	Output current	
Voltage	Output voltage	

* indicates the default value.

● Setting Procedure

- 1 Display the "Analog Setting" screen while in setting mode.
- 2 Press the [ENTER] key. The "Analog Output Selection" screen will be displayed.
- 3 Press the [ENTER] key. The present output type will be displayed.
- 4 Press the [UP]/[DOWN] key to make output type changes. (Example: Changing the output type to voltage output.)
- 5 Press the [ENTER] key to determine the output type.

■ Analog Scaling

This function scales analog current output or analog voltage output to any desired value.

Measurement values A and B on any two measurement point can be scaled with currents a and b or voltages a and b on any two points. Analog output is turned ON according to the scaling set for analog output selection.

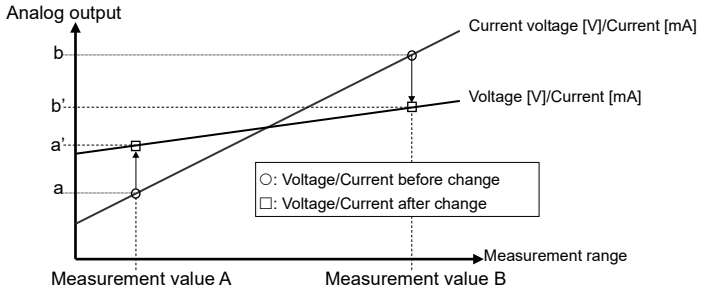

Item	Panel display	Setting range	Function	Initial value
Meas A	<input type="text" value="n-a"/>	-95000 to +95000	Make measurement value, current, and voltage settings.	Negative measurement range
Meas B	<input type="text" value="n-b"/>	-95000 to +95000		Positive measurement range
Current a (*1)	<input type="text" value="c-a"/>	+4.000 to 20.000		<input type="text" value="4000"/>
Current b (*1)	<input type="text" value="c-b"/>	+4.000 to 20.000		<input type="text" value="20000"/>
Voltage a (*2)	<input type="text" value="u-a"/>	0 to +10.000		<input type="text" value="0000"/>
Voltage b (*2)	<input type="text" value="u-b"/>	0 to +10.000		<input type="text" value="10000"/>

*1 Not displayed when "Voltage" is selected for "Analog Output Selection."

*2 Not displayed when "Current" is selected for "Analog Output Selection."

Supplemental remarks

The following default measurement values A and B apply.











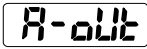

Type	Diffuse reflection		Specular reflection	
	Meas. Val A	Meas. Val B	Meas. Val A	Meas. Val B
30 mm	-4 mm	+4 mm	-2 mm	+2 mm
50 mm	-10 mm	+10 mm	-5 mm	+5 mm
85 mm	-20 mm	+20 mm	-10 mm	+10 mm
120 mm	-60 mm	+60 mm	-	-
250 mm	-150 mm	+150 mm	-	-

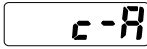
❗ CHECK

- The display limit of the measurement value is ± 95000 . Make sure that the setting value does not exceed the display limit.
- Check the input range of your input device such as AD board before setting.
- The decimal point position of measurement values varies with each model.

● Setting Procedure

Setting current a (current for measurement value A)

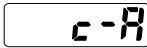
- 1 Display the "Analog Setting" screen while in setting mode. 
- 2 Press the [ENTER] key. The "Analog Output Selection" screen will be displayed.  
- 3 Press the [DOWN] key twice. The "Current a" screen will be displayed.  
- 4 Press the [ENTER] key. The present set value will be displayed. The leftmost digit will be selected.  
- 5 Press the [UP]/[DOWN] keys together to change the selected digit. After all the changed digits have blinked the sign can be changed. For details, refer to page 3-8 "Making Setting Value Changes."  
- 6 Press the [UP]/[DOWN] key to change the value of the selected digit. (Example: Changing the value to 5.000 [mA].)  
- 7 Press the [ENTER] key to determine the set value.  

3-3-7 Alarm Settings

ProS

■ Analog Output at Alarm AL - A

This function is used to set the analog output status at alarm operation.

Analog output in the alarm state (where measurement is disabled owing to lack of light) can be kept on hold or set to a fixed value selectively.

Setting	Function	Panel display
Hold	Holds the analog output immediately before the alarm.	Hold
Fixed Value	Fixed-value output	F i U

* indicates the default value.

Supplemental remarks

- A fixed current output of 21.6 [mA] or voltage output of +11.000 [V] applies.
- The fixed value is applied to the side set with "Analog Output Selection."

CHECK

- Check the input range of your input device such as AD board before setting.
- The above settings will apply when there is data instability.

● Setting Procedure

- 1 Display the "Alarm Setting" screen while in setting mode. ProS
- 2 Press the [ENTER] key. The "Analog output at alarm" will be displayed. ENTER AL - A
- 3 Press the [ENTER] key. The Hold/Fix will be displayed. ENTER Hold
- 4 Press the [UP]/[DOWN] key to set the system to Hold/Fix. (Example: Changing the selection to the fixed value.) SELECT F i U
- 5 Press the [ENTER] key to determine the set value. ENTER AL - A

3

■ Digital Output at Alarm AL -d

This function is used to set the digital output status at alarm operation.

This function makes settings related to digital output (on the digital display block of the sensor head and measurement values over serial communication) in the alarm state (where measurement is disabled owing to lack of light). The digital data will be set to +99999 if the fixed value is selected. The measurement value immediately before the alarm will be displayed if the system is set to hold.

TECHNIQUE

Selecting the fixed value can detect the alarm issued status easily from the measurement result. With this convenient function, the alarm status can be confirmed as well when the measurement value is loaded by data buffering function.

Setting	Function	Panel display
Hold	Holds the digital output immediately before the alarm.	Hold
Fixed Value	Fixed-value output	F 12

* indicates the default value.

❗ CHECK

- If the alarm state occurs after the fixed value is selected, judgment output interlocked with digital output will be turned ON.

● Setting Procedure

- 1 Display the "Alarm Setting" screen while in setting mode. Pras
- 2 Press the [ENTER] key. The "Analog output at alarm" screen will be displayed. ENTER AL -A
- 3 Press the [DOWN] key once. The "Digital output at alarm" screen will be displayed. ▲
SELECT
▼ AL -d
- 4 Press the [ENTER] key. The present Hold/Fix will be displayed. ENTER Hold
- 5 Press the [UP]/[DOWN] key to select Hold/Fix. (Example: Changing the selection to the fixed value.) ▲
SELECT
▼ F 12
- 6 Press the [ENTER] key to determine the set value. ENTER AL -d

■ Alarm Delay Times

This function holds the previous normal value up to the setting number of times if an alarm is issued.

The previous normal value will be kept on hold up to the setting number of delay times if an alarm is issued (where measurement is disabled owing to lack of light).

Alarm output (OUT3) will be turned ON when the alarm status continues more than the setting number of delay times, and analog output and digital output will be turned ON according to the setting for analog output at alarm and the setting for digital output at alarm, respectively.

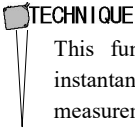









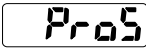

TECHNIQUE

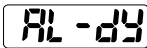
This function is effective if the user does not require the output of instantaneous alarms resulting for the surface condition changes of measurement objects.

Setting range	Function	Initial value
0 to 65534	0 (OFF) to 65534 times	
65535	Holds the measurement value before the alarm.	

● Setting Procedure

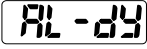
- 1 Display the "Alarm Setting" screen while in setting mode. 
- 2 Press the [ENTER] key. The "Analog output at alarm" screen will be displayed.  
- 3 Press the [DOWN] key twice. The "Alarm Delay Times" screen will be displayed.  
- 4 Press the [ENTER] key. The number of alarm delay times will be displayed. The leftmost digit will be selected.  
- 5 Press the [UP]/[DOWN] keys together to change the selected digit.  
- 6 Press the [UP]/[DOWN] key to change the value of the selected digit. (Example: Changing the value to 0 times (OFF).)  
- 7 Press the [ENTER] key and determine the number of delay times. 

3-3-8 COM Settings

Make COM settings through the control panel. No COM settings are possible with serial communications commands.

■ Terminating Resistor Selection

This function selects the terminating resistor for the sensor head connecting to the host device over RS-422/485.

Be sure to select R3 if the system is connected to RS-422 equipment.

If a number of sensor heads are connected to RS-485 equipment, set R3 for the terminating sensor and the rest of the sensors to OFF.

* The communication of the system, if unstable, may be improved by selecting R1 or R2.

Setting	Function	Panel display
OFF	Turn OFF terminating resistors	
R1	Terminating resistor R1	
R2	Terminating resistor R2	
R3	Terminating resistor R3	

* indicates the default value.

● Setting Procedure

- 1 Display the "COM Setting" screen while the system is in setting mode.

- 2 Press the [ENTER] key. The "Terminating Resistor Selection" screen will be displayed.



- 3 Press the [ENTER] key. The present terminating resistor will be displayed.



- 4 Press the [UP]/[DOWN] key to change the terminating resistor. (Example: Changing the resistor to OFF.)



- 5 Press the [ENTER] key to determine the terminating resistor.







■ Sensor No.

This function is used to set the number of each sensor head multi connected to an RS-485 device.

Be sure to set each connecting sensor head number with no duplication.

Setting range	Function	Initial value
01 to 16	Set sensor numbers 01 through 16 in sequence.	<input type="text" value="01"/>

● Setting Procedure

- 1 Display the "COM Setting" screen while in setting mode.
- 2 Press the [ENTER] key. The "Terminating Resistor Selection" screen will be displayed. 
- 3 Press the [DOWN] key once. The "Sensor No." screen will be displayed. 
- 4 Press the [ENTER] key. The present sensor number will be displayed. 
- 5 Press the [UP]/[DOWN] key to change the sensor number. (Example: Changing the sensor number to 16.) 







Supplemental remarks

Press the [UP]/[DOWN] keys together for at least 2 seconds to move the set value at high speed.

- 6 Press the [ENTER] key to determine the sensor number. 

■ Baud Rate

This function is used to set the communication speed.









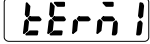

Setting	Function	Panel display
9600	9,600 bps	
19200	19,200 bps	
38400	38,400 bps	
115200	115,200 bps	
230400	230,400 bps	
460800	460,800 bps	
921600	921,600 bps	

*  indicates the default value.

❗ CHECK

- Lower the communication speed if stable communication with the host device is not possible.

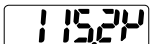
● Setting Procedure

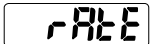
- 1 Display the "COM Setting" screen while in setting mode. 
- 2 Press the [ENTER] key. The "Terminating Resistor Selection" screen will be displayed.  
- 3 Press the [DOWN] key twice. The "Baud Rate" screen will be displayed.  
- 4 Press the [ENTER] key. The communication speed will be displayed.  
- 5 Press the [UP]/[DOWN] key to make communication changes. (Example: Changing the communication speed to 115,200 bps.)  
- 6 Press the [ENTER] key to determine the communication speed.  

■ Connection Mode node

This function is used to select the performance settings for measurement data output to the host device.





Select the operation settings for measurement data output to the host device.

This section provides information on the condition that the RS-422 device is connected 1-to-1 and the RS-485 device is connected 1-to-N (sensor heads) to the system. For the connection method, → refer to "4-1 Communications Specifications - Connecting Example with External Device." For details of the dedicated output format, → refer to "4-2 Type and Format of Commands".

Setting	Connection method	Function	Panel display
RS-422 handshake	RS-422	Transmits the result data (a response command) in response to a request command from the host device. All commands can be received.	422-1
RS-422 Timing		Transmits the measured value in the exclusive output format when timing input is ON while the system is in this mode.	422-2
RS-422 Continuous		Transmits the measured value continuously in the exclusive output format after this mode is selected.	422-3
RS-485 Multiple	RS-485	Up to 16 sensor heads are connected to the host device. Transmits the result data (a response command) in response to a request command from the host device. No sensors outside the designated range will not respond.	485-n

* indicates the default value.















● Setting Procedure

- 1 Display the "COM Setting" screen while in setting mode. Prog
- 2 Press the [ENTER] key. The "Terminating Resistor Selection" screen will be displayed.
 tErn1
- 3 Press the [DOWN] key three times. The "Connection Mode" screen will be displayed.
 node
- 4 Press the [ENTER] key. The present connection mode will be displayed.
 422-1
- 5 Press the [UP]/[DOWN] key to change the connection mode. (Example: Changing the connection to RS-485 multi connection.)
 485-n
- 6 Press the [ENTER] key to determine the connection mode setting.
 node

■ Sending Delay Time











This is a useful function if the connection mode is set to RS-485 multi.

Select the sensor's delay time in response to each command transmitted from the host device.

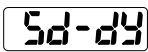
Setting	Function	Panel display	Setting	Function	Panel display
0	No delay time		10	Delay time 10ms	
0.1	Delay time 0.1ms		20	" 20ms	
0.2	" 0.2ms		50	" 50ms	
0.5	" 0.5ms		100	" 100ms	
1	" 1ms		200	" 200ms	
2	" 2ms		500	" 500ms	
5	" 5ms		1000	" 1000ms	

*  indicates the default value.

● Setting Procedure

- 1 Display the "COM Setting" screen while in setting mode. 
- 2 Press the [ENTER] key. The "Terminating Resistor Selection" screen will be displayed.  
- 3 Press the [DOWN] key four times. The "Sending Delay Time" screen will be displayed.  
- 4 Press the [ENTER] key. The delay time setting will be displayed.  
- 5 Press the [UP]/[DOWN] key to change the connection mode. (Example: Changing the delay time to 20 ms.)  
- 6 Press the [ENTER] key to determine the sending delay time setting.  

❗ CHECK

When sending the next command after HL-G1 returns a response while the RS-485 is connected, leave time of at least 200 μ s or more.

3-3-9 System Settings

Pro7

■ Timing Mode t 1

This function is used to set the timing input mode.

Set the operation of the system with timing input turned ON.

For the operation of the system in this mode, refer to "2-4 Timing Chart."

Setting	Function	Panel display
Hold	Measurement hold with timing input	Hold
One Shot	Measurement variable with timing input	1Shot

* indicates the default value.

● Setting Procedure

- 1 Display the "System Setting" screen while in setting mode. Pro7
- 2 Press the [ENTER] key. The "Timing Mode" screen will be displayed. t 1
- 3 Press the [ENTER] key. Hold/One Shot will be displayed. Hold
- 4 Press the [UP]/[DOWN] key to select Hold or One Shot. (Example: Changing the selection to "One Shot.") 1Shot
- 5 Press the [ENTER] key to determine the set value. t 1

3

■ Laser Control LASER

This function is used to select the laser emission/stop.

This function makes it possible to stop unrequired laser emission while the system is not in measurement operation.

Setting	Function	Panel display
Emission	Laser emission is ON	ON
Stop	Laser emission is OFF	OFF

* indicates the default value.

❗ CHECK

The system will be in a data unfixed state when the laser control is set to "Stop," and the data unstable state continues until "Emission" is set again.

The state returns to the measurement state when the laser is emitted again.

3

● Setting Procedure

- 1 Display the "System Setting" screen while the system is in setting mode. Pro1

- 2 Press the [ENTER] key. The "Timing Mode" screen will be displayed.
 t1

- 3 Press the [DOWN] key once. The "Laser Control" screen will be displayed.
 LASER



- 4 Press the [ENTER] key. The ON/OFF will be displayed.
 ON

- 5 Press the [UP]/[DOWN] key to select ON/OFF. (Example: Changing the selection to OFF.)
 OFF

- 6 Press the [ENTER] key to determine the set value.
 LASER

■ Eco Mode

This function turns OFF the LED indicators on the control panel while in RUN mode for energy saving.











Setting	Details	Panel display
Eco-OFF	Eco Mode is OFF.	
Eco-ON	Only LEDs on the digital display will be turned OFF.	
Eco-FULL	Other than LASER indicator, All the LEDs will be turned OFF.	

*  indicates the default value.

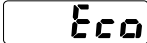
Supplemental remarks

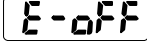
- The display will be restored by switching while the LEDs are turned OFF while the system is in eco mode. The LEDs will be turned OFF again if the system is not operated for 20 seconds.
- The LEDs will be always lit while the system is in setting mode.

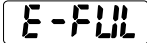

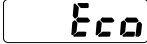



● Setting Procedure

- 1 Display the "System Setting" screen while the system is in setting mode. 
- 2 Press the [ENTER] key. The "Timing Mode" screen will be displayed.  
- 3 Press the [DOWN] key twice. The eco mode screen will be displayed.  
- 4 Press the [ENTER] key. The present mode setting will be displayed.  
- 5 Press the [UP]/[DOWN] key to make mode changes. (Example: Changing the mode to Eco-FULL.)  
- 6 Press the [ENTER] key to determine the mode setting.  

■ View Version

This function is used to take the following procedure that displays the program version of the sensor.

● Setting Procedure

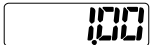
- 1 Display the "System Setting" screen while in setting mode. 
- 2 Press the [ENTER] key. The "Timing Mode" screen will be displayed.  
- 3 Press the [DOWN] key three times. The "View Version" screen will be displayed.  
- 4 Press the [ENTER] key. The present version will be displayed.  

3-3-10 Other System Settings

■ Initialize

This function is used to delete all the setting contents in the memory and returns them to the factory default settings.

❗ CHECK

- When the initialization of the system is executed through the operation of the panel, all settings will return to the factory default settings. When the initialization of the system is executed through the operation of the panel, all settings except COM settings and environment settings will return to the factory default settings.
- The initialized setting contents will not be saved if the system is initialized with the communications command from the high-function type. To maintain the initialized state after the system is turned OFF, be sure to execute the “Save” command.
- When the “initialization” is executed, the data unfixed status may occur temporarily.

● Setting Procedure

- 1 Turn ON the system while pressing the [ENTER] key.

The initial screen will be displayed after the startup screen appears.

The memory is initialized and the system is set to RUN mode.

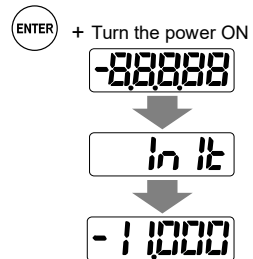

■ Save

There is a difference in setting saving method between the operation of the panel and the use of the communications command.

● Setting Changes in Control Panel of Sensor Head

Press the [ENTER] key and save the change in each item.

When the system is turned ON again, the last saved settings will be reflected.

● Setting Changes over RS422/485 Communication (High-function type only: E.g., communications command, dedicated console (sold separately), and Setting and Monitoring Software HL-G1SMI)

Be sure to execute "Save" to maintain setting changes after the system is turned ON again.

The timing input state cannot be saved. Timing input will be OFF right after the system is turned ON or a memory change is made.

● Saving input over the multi-input (MI) line

Multi-input can be entered for a certain period to save settings made.

For details, → refer to "2-1 Functions and Arrangements of I/O Terminal Block".

3-3-11 Measurement Control with External Input

■ Timing

This function makes it possible to hold the measurement value at the desired timing.

The measurement value will be kept on hold with external input timing (TM). The judgment output is kept on hold as well simultaneously.

Timing settings can be executed with communications command but not with the operation of the panel.

For the operation of the system in this mode, → refer to "2-4 Timing Chart".

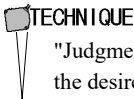

"Judgment Output" will be kept on hold by setting the timing input to "ON" at the desired timing. This enables loading of the judgment result at a later time.

❗ CHECK

- The timing input status cannot be stored by executing "Save". Timing input will be OFF right after the system is turned ON or a memory change is made.
- If the timing mode is set to "One Shot," the internal memory will be cleared (set to timing OFF) after one-shot processing is executed when timing ON is executed with a communications command.
- If the timing mode is set to "Hold," the external input status will be reflected on the memory.

■ Zero Set

This function makes it possible to set the measurement value to zero at the desired timing.

The measurement value can be set to zero at the desired timing by using external multi input (MI).

Input a specified pulse width as multi input.

Zero set settings can be executed with communications commands and the operation of the panel.

For the operation of the system in this mode, → refer to "2-4 Timing Chart".

❗ CHECK

- An offset value will be set by executing "Zero Set" after setting the offset value.
- The sensor head does not save setting changes made over the multi-input line. Save the settings over the multi-input line, through the panel, with the communications command, or with the operation of the console if the settings need to be maintained after the system is turned OFF.

- Setting Procedure

- 1 Press the [UP]/[DOWN] keys together while in Run mode.
Zero Set will be executed.



■ Reset

The function resets the measurement value.

At the time of making a peak measurement, valley measurement, or peak-to-peak measurement with external multi input (MI), the measurement value kept on hold at the desired timing can be reset.

Input a specified pulse width as multi input.

The pulse width can be input into the high-function type through a communications command.

For details, → refer to "2-4 Timing Chart".

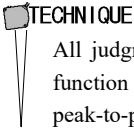

TECHNIQUE

All judgment outputs will be turned OFF when "Reset" is executed. This function can be applied to judge each measurement object for peak, valley, or peak-to-peak measurements.

❗ CHECK

- The data will be in an unfixed status when "Reset" is executed, and the analog output outputs the alarm set in the "Analog Output at Alarm" (initial value holds the analog output immediately before the alarm), and the judgment output becomes a HI judgment.
- If Reset ON is executed by a communications command, the memory contents will be cleared to zero after Reset is executed.

● Setting Procedure

- 1 Press the [UP]/[ENTER] keys together while in Run mode.
Reset will be executed.



3-3-12 Buffering Settings (High-function type only)

Buffering is a function to accumulate measurement data in the sensor head memory and load them to external control devices.

A maximum of 3,000 measurement data items can be temporarily accumulated in the built-in memory of the sensor head before loading them to the external control device, such as a PC. All accumulated data can be loaded by using communication control over RS-422 or RS-485 or with the Setting and Monitoring Software HL-G1SMI.

TECHNIQUE

The Setting and Monitoring Software HL-G1SMI makes it possible to accumulate and retrieve measurement data with the operation of the mouse in the case of using the buffering function. This Intelligent Monitor SIM is useful for the confirmation or verification of measurement data because it converts the data into CSV data format. CSV data can be used for graphic display, save, replay of the measurement data, and opened in Excel.

Supplemental remarks

For buffering over RS-422/485, → refer to "4-3 Command List".

The Setting and Monitoring Software HL-G1SMI can be downloaded from the website of Panasonic Industry.

CHECK

- It is necessary to write a program over RS-422/485 to execute buffering.
- Buffering settings cannot be set through the control panel. Make settings with serial communications commands.

■ Data Buffering Operation

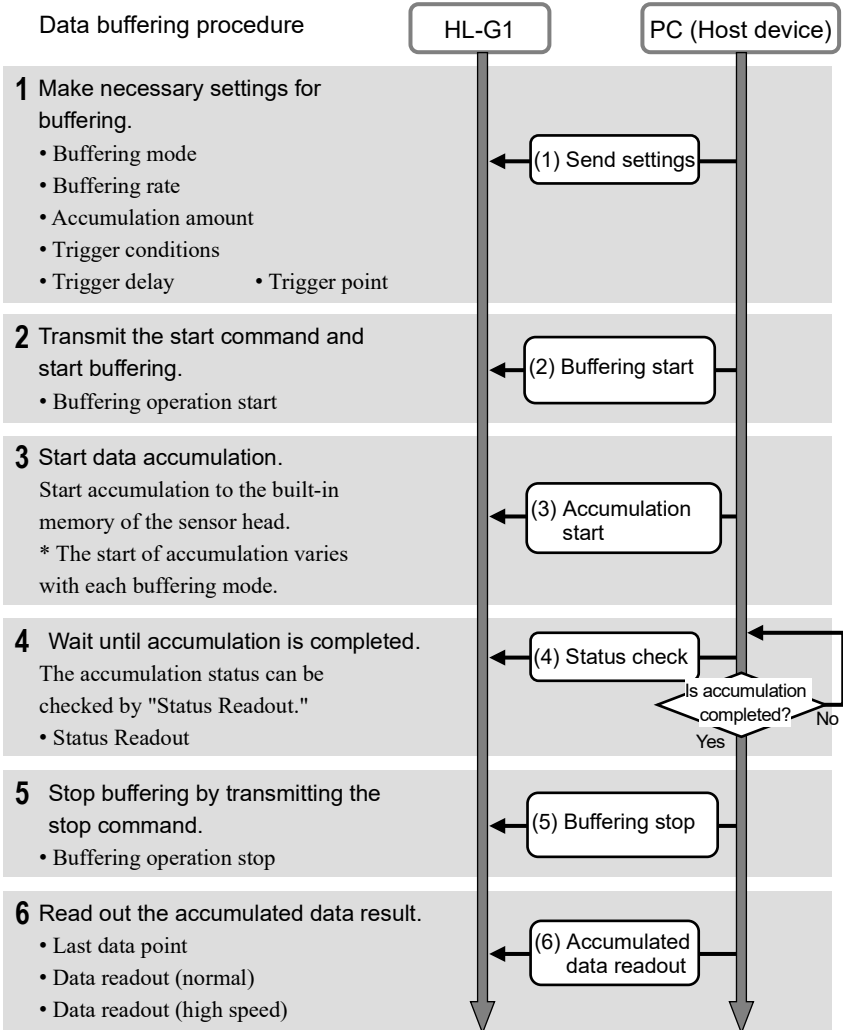

❗ CHECK

No settings related to buffering can be changed while the system is in buffering operation. Change the settings after stopping the buffering operation of the system.

■ Buffering Mode

There are two types of buffering modes, either one of which can be selected. "Continuous Mode" is set by default.

Continuous Mode

- Data accumulation to the built-in memory of the sensor head start with the start of buffering.
- Accumulation will stop when the amount of accumulation reaches the setting value or when buffering operation stops.

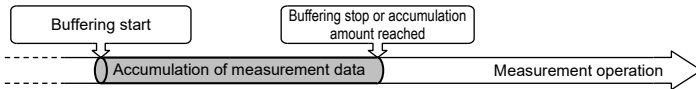

Trigger Mode

- When buffering operation starts, trigger generation will be set to stand-by status.
- The measurement data before and after the trigger point where the trigger is generated is accumulated into the built-in memory of the sensor head.
- Accumulation will stop when the amount of accumulation reaches the setting value or when buffering operation stops.

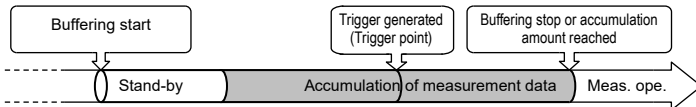

■ Buffering Rate

The buffering rate can be set for accumulating the measurement data for a long duration by taking adequate sampling cycle intervals.

Select from 1 (all measurement data), 1/2, 1/4, etc. to 1/65535.

The buffering rate is set to “1/10” by default.

If 1/4 is selected for example, measurement data will be accumulated once every four sampling cycles.

TECHNIQUE

All measurement data can be accumulated. If measurement data deviation is small at each sampling cycle, however, the duration of data accumulation longer than that performed per sampling cycle can be set with an appropriate accumulation interval of measurement data specified. This is useful for the effective use of memory since the accumulated amount of data items is limited.

■ Accumulated Amount

This function sets the accumulated amount of measurement data items.

This function sets the accumulated amount of measurement data items in a range of 1 to 3000.

The accumulated amount is set to “3000” by default.

CHECK

Accumulation will not start unless the “trigger point” settings for the “accumulated amount” of data items are correct.

■ Trigger Points

When the buffering mode is set to trigger mode, measurement data can be loaded by setting the data as a trigger point at the generation of the trigger.

The setting range is in a range of 1 to the "accumulated amount" of data items.
The value is set to 300 by default.

❗ CHECK

- Accumulation will not start if the "trigger point" is set to a larger value than the setting "accumulation amount."
- If the "Trigger Delay" function is set, the system can load the measurement data from the trigger delayed data point after the setting trigger is generated.

■ Trigger Delay

This function is used for delaying the timing of trigger detection when the buffering mode is set to trigger mode.

This function is used to set the number of sampling times for the trigger delay. The setting range is 0 to 65535.

The status during the trigger delay is indicated as "Accumulating." The trigger delay is set to "0" by default.

For trigger mode:

This function is used to load measured data between the moment the preset trigger is generated and the moment the delayed trigger point set by this function.

❗ CHECK

When the buffering rate is already set, the trigger delay will be counted with the extended sampling in accordance with the setting.

■ Trigger Conditions

This function is used for setting the trigger generation conditions when the buffering mode is set to trigger mode.

A value the same as or higher or lower than a threshold or the time of alarm occurrence or release can be set as a trigger condition if timing input is ON.

The value is set to "At timing input ON" by default.

❗ CHECK

- Keep in mind that the "Alarm Delay Times" set will become effective if "At alarm occurred" is set as a trigger condition.

Ex) If the "Buffering Mode" is set to trigger mode, the operation of each trigger condition is shown below:

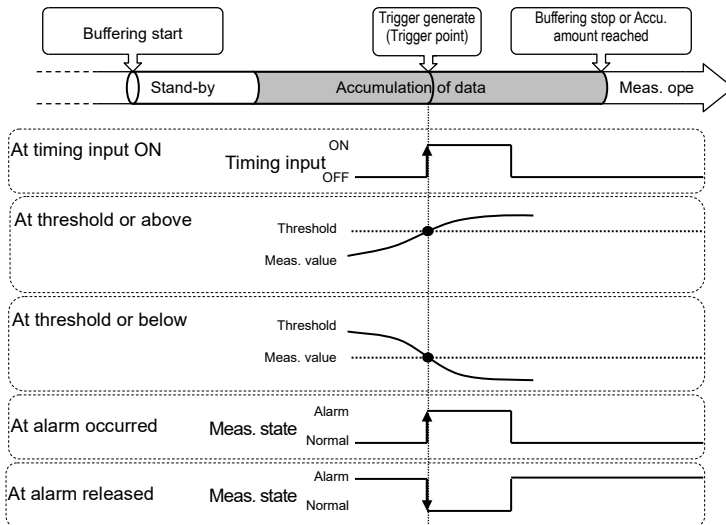

❗ CHECK

Normally, the measurement value is kept on hold when timing input is ON. Only if the buffering mode is set to "trigger mode" and this function is set to "At timing input ON," however, the measurement value will not be kept on hold at the moment timing input is ON while the system is in buffering operation.

■ Buffering Operation

This function accumulates data while the system is in buffering operation.

Set necessary parameters in advance and start buffering.

❗ CHECK

- All settings related to buffering cannot be changed during buffering.
- Non-buffering status cannot be set by only stopping buffering.

■ Status Readout

This function checks the status of measurement data accumulation.

Use this function for checking the accumulation status before reading out the accumulated data. When the status is checked, the sensor head responds one of the following conditions.

Status	Details
Non-buffering	Buffering is not executed at all after turning on the power supply or after initialization or buffering is stopped while waiting for the trigger after buffering has started.
Wait for Trigger	Waiting for the trigger after buffering has started.
Accumulating	Buffering has started and measurement data is being accumulated or trigger has been generated and measurement data is being accumulated.
Accumulation Completed	The accumulation amount has reached the setting value or buffering has stopped.

■ Last Data Point

The accumulation status can be read out from the data amount.

The "Final Data Point" will be set to "0" when the "Status Readout" is set to Non-buffering or Wait for Trigger.

■ Binary Readout of Buffering Data

The accumulated measurement data in the sensor head memory can be read out.

Data in a range from 1 to the readout result of the last data point is specified and read out.

❗ CHECK

To read out the buffering data, stop buffering and check the "Final Data Point." The accumulated data to the final data point can be read out only when the result of "Status Readout" is Accumulation Completed and the final data point is other than 0.

3

4

Communications Control

This Chapter provides information on RS-422 and RS-485 communications control.

4

4-1 Communications Specifications	4-2
4-2 Type and Format of Commands	4-7
4-2-1 Commands	4-7
4-2-2 Command Formats	4-9
4-3 Command List	4-19
4-4 Setting Address List	4-25

4-1 Communications Specifications

■ Specifications

The system has the following specifications. The user can make setting changes according to the external host device in use.

Item	Setting	
	RS-422	RS-485
Communication mode	Full duplex	Semi-duplex
Communication speed	9,600/19,200/ 38,400 /115,200/230,400/460,800/ 921,600 bps	
Synchronization system	Start-stop transmission (Asynchronous)	
Transmission code	ASCII	
Data length	8 bits	
Parity check	None	
Stop bit length	1 bit	
End code	CR(ODH)	
BCC	Yes*1	

*1 To omit BCC calculation, enter "***" (2AH, 2AH) to BCC.

*2 Settings in bold letters indicate default settings (before shipping).

■ Pin Arrangement

No.	Wiring color		Signal name	Signal direction		Description	
				HL-G1	External host device		
11	Twisted-pair wire	Green	+SD	Output	→	Input	Transmitted data signal (+) Usually connected to +RD (+RXD) of external device
12		Sky Blue	-SD	Output	→	Input	Transmitted data signal (-) Usually connected to -RD (-RXD) of external device
13	Twisted-pair wire	Orange	+RD	Input	←	Output	Received data signal (+) Usually connected to +SD (+TXD) of external device
14		Yellow	-RD	Input	←	Output	Received data signal (-) Usually connected to -SD (-TXD) of external device
15	Shield		SG	← Connected →		Signal ground Connected to SG (SG) of external device	

■ Connecting Example with External Device

● RS-422 1-to-1 connection

Select “RS-422 handshake”, “RS-422 timing”, or “RS-422 continuous” for the COM setting connection mode.

Set the prefix to 01.

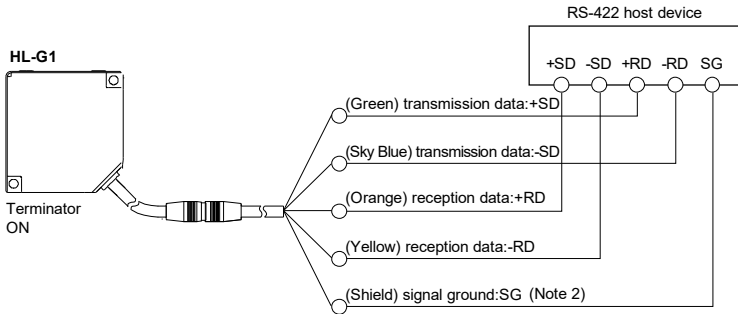

(Note 1) The transmission data cable and reception data cable are both twisted-pair cables.

(Note 2) The shield is connected to the 0-V side of the power supply line inside the sensor.

(Note 3) Be sure to connect the signal ground.

(Note 4) When connecting to the host device, make sure that no potential difference is created between the 0 V side of the power supply line for the HL-G1 and the GND of the power supply for the host device. A difference in potential between the HL-G1 and the RS-422 connected device may cause the HL-G1 or the connected device to malfunction.

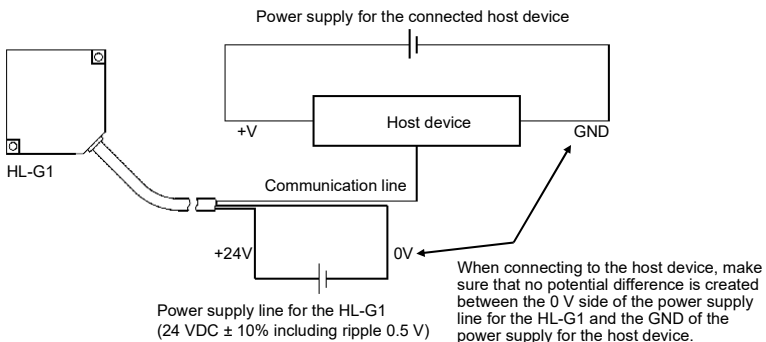

● RS-485 1-to-N connection

Select “RS-485 multi” for COM setting connection mode.

Set the prefix with no duplication. Possible to connect up to 16 units.

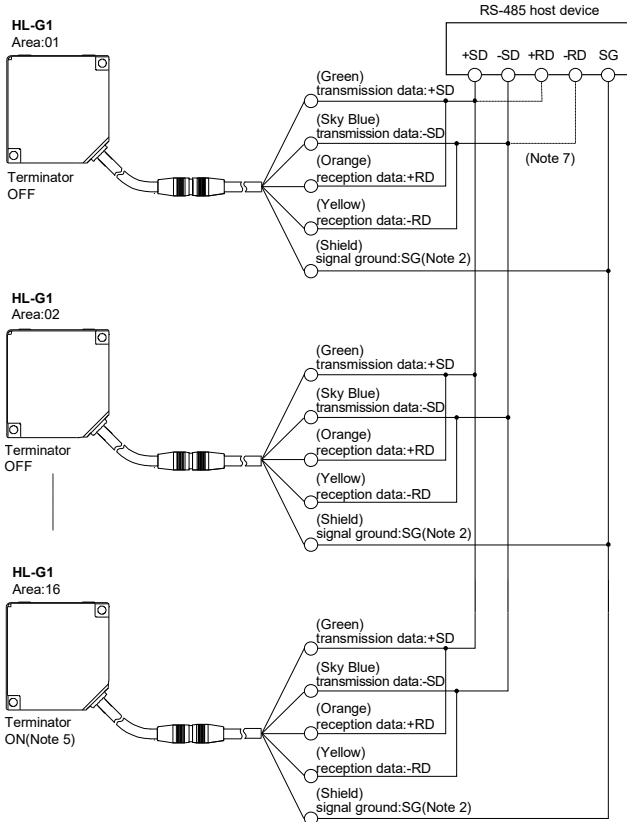

(Note 1) The transmission data cable and reception data cable are both twisted-pair cables.

(Note 2) The shield is connected to the 0-V side of the power supply line inside the sensor.

(Note 3) Be sure to connect the signal ground.

(Note 4) When connecting to the host device, make sure that no potential difference is created between the 0 V side of the power supply line for the HL-G1 and the GND of the power supply for the host device. A difference in potential between the HL-G1 and the RS-485 connected device may cause the HL-G1 or the connected device to malfunction.

(Note 5) The sensor has a built-in terminating resistor. Be sure to turn ON the terminating resistor of the terminating sensor.

- (Note 6) Perform transition wiring for the transmission path.
- (Note 7) Connect the wires according to the specification of the top equipment.
- (Note 8) When sending the next command after HL-G1 returns a response while the RS-485 is connected, leave time of at least 200 μ s or more.

■ Communications Protocol

- Make communications specification settings.

1. Make communications specification settings for the HL-G1.

The table in "4-1 Communications Specifications" - "Specifications" shows the communications specifications for the HL-G1. Make settings according to the operating conditions.

2. Make communication specifications for the host device.

Read through the operation manual of the external host device and change the communications settings for the host device in conformity with the settings for the HL-G1. Otherwise, make settings for the HL-G1 in conformity with the settings for the external host device.

■ Communications Condition Changes

When the baud rate is changed, save the setting and restart the sensor head so that the setting will be reflected.

4-2 Type and Format of Commands

4-2-1 Commands

■ Data Transmission/Reception

● Data Transmission/Reception

This section explains how to set or change various parameters or confirm and read measurement values by sending commands from an external host device to the HL-G1.

(1) Normal sequence to read setting data

The following data transmitting/receiving sequence will be used when request communication data instructing setting data read (with the head character of the command on the request communication data set to R) transmitted from the external host device to the HL-G1 is normal.

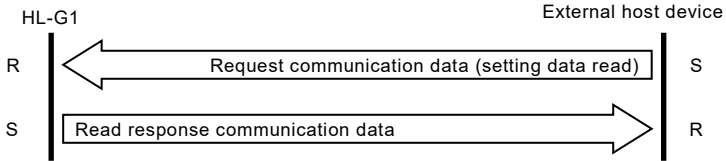

(2) Normal sequence to transmit/receive data on data setting or operation instruction

The following data transmitting/receiving sequence will be used when request communication data instructing setting data read (with the head character of the command on the request communication data set to W) transmitted from the external host device to the HL-G1 is normal.

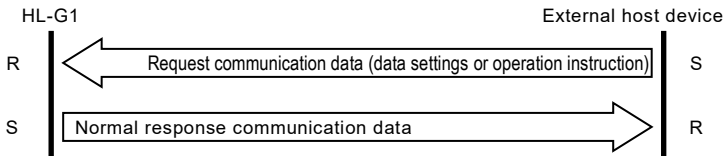

(3) Abnormal sequence to transmit/receive data

The following data transmitting/receiving sequence will be used if request communication data transmitted from the external host device to the HL-G1 is abnormal (with data range error or garbled characters).

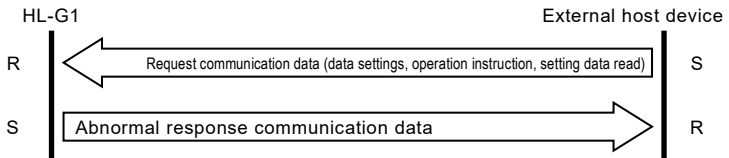

4-2-2 Command Formats

The following section explains seven types of command formats transmitted from an external host device to the HL-G1.

FORMAT 1 General Purpose

The following command formats are used to read or make general measurement mode settings or operating conditions.

• Read Command

Read command formats are used to read operating conditions.

Request communication data

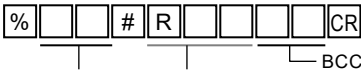

Destination no. Command

Normal response data

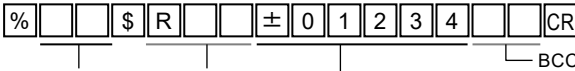

Sender no. Command

Data block: 1-character symbol +
5-character integral part (no zero suppress)

Ex

Reading the sampling cycle setting value for sensor 01 in the RS-422 handshake mode or the RS-485 multi-mode

Request communication data



Normal response data

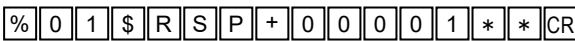

Sampling cycle:
500 [μs]

- Data Setting/Operation Instruction Command

Data setting/operation instruction command formats are used to make data settings or give operating instructions.

Request communication data

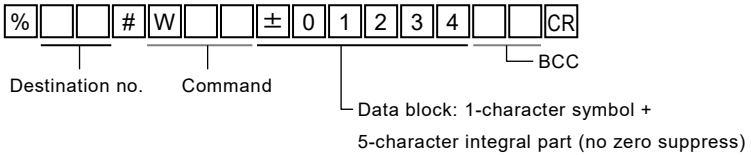

Normal response data

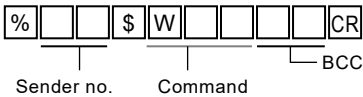

Ex

Setting an average number of 256 times for sensor 02 in the RS-485 multi-mode.

Request communication data

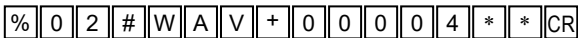

Normal response data



FORMAT 2 Value Setting

The following value setting command formats are used to set seven-digit numeric values (measurement values and numeric values) with the decimal point omitted.

- Read Command

Request communication data

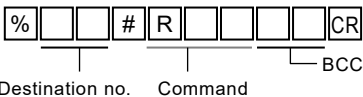

Normal response data

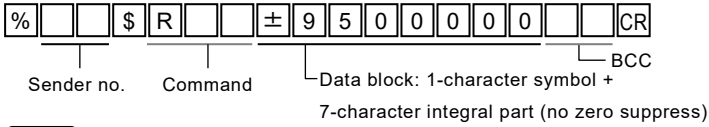
**Ex**

Reading the present measurement value for sensor 03 in the RS-485 multi-mode.

Request communication data



Normal response data

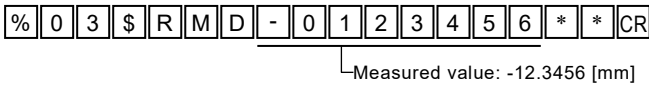

- Data Setting/Operation Instruction Command

Request communication data

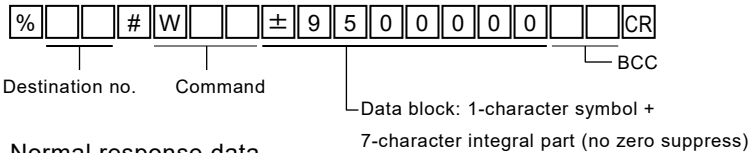

Normal response data

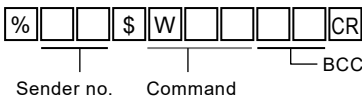
**Ex**

Setting +5.5 [mm] as displacement judgment threshold a for sensor 04 in the RS-485 multi-mode.

Request communication data

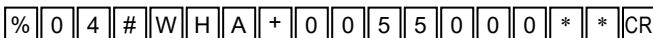

Normal response data

% 0 4 \$ W H A * * CR

FORMAT 3 All Outputs Read

The following special command formats are used to read all measurement value, received light intensity, and judgment output conditions together.

Request communication data

% [] [] # R M B [] [] CR

Destination no. Command

BCC

Normal response data

Sender no. Command Measured value: 1-character symbol + 7-character integral part (no zero suppress) Light intensity: 4-character integral part (no zero suppress)

% [] [] \$ R M B ± 9 5 0 0 0 0 0 1 0 2 3

(1) (2) (3) (4) [] [] CR

Output status

- (1): OUT1 0or1
- (2): OUT2 0or1
- (3): OUT3 0or1
- (4): ALARM 0or1

Ex

Reading all “logic” outputs of judgment output selection for sensor 01 in the RS-422 handshake mode or the RS-485 multi-mode.

Request communication data

% 0 1 # R M B * * CR

4

Normal response data

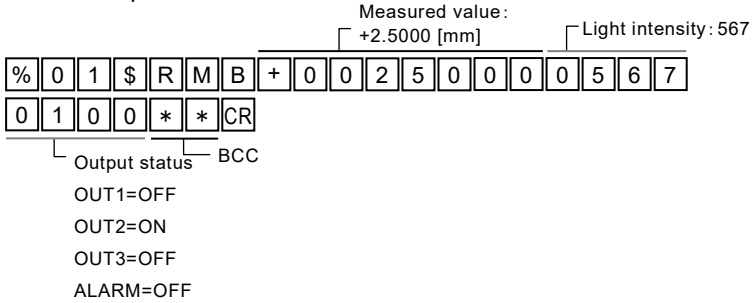
**FORMAT 4** Normal Read of Buffering Data

The following special command formats are used to read buffering measurement data in 7-digit numeric sequence format.

Request communication data

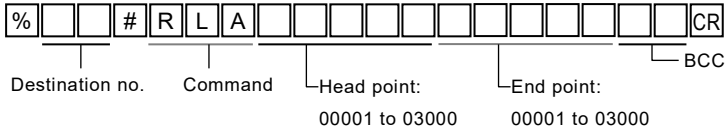

Normal response data

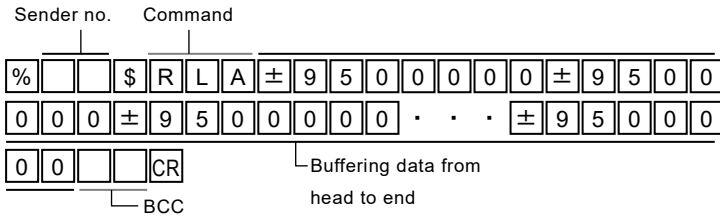

FORMAT 5 Read of Differential Data in Buffering Data

The following special command formats are used to read buffering measurement data in signed differential sequence format.

Request communication data

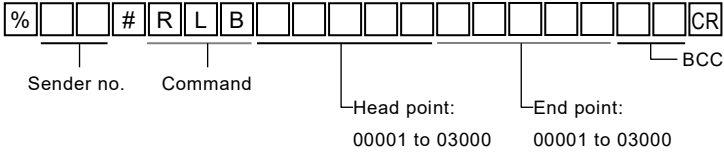

Normal response data

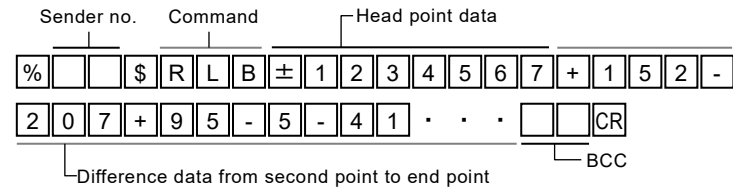

Data is stored in the following head data format in the specified head point. The difference from the previous data will be returned for data on the second point and each succeeding point.

Head data format:

1-character symbol + 7-digit integral part (no zero suppress)

<Example using the reply command shown above>

+123.4567, +123.4719, +123.4512, +123.4607, +123.4602, +123.4561, ...
 ↑ ↑ ↑ ↑ ↑
 (+0.0152) (-0.0207) (+0.0095) (-0.0005) (-0.0041) ...

FORMAT 6 Binary Read of Buffering Data

The following special command formats are used to read buffering measurement data in binary sequence format.

Request communication data

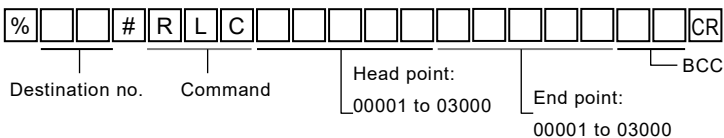

4

Normal response data

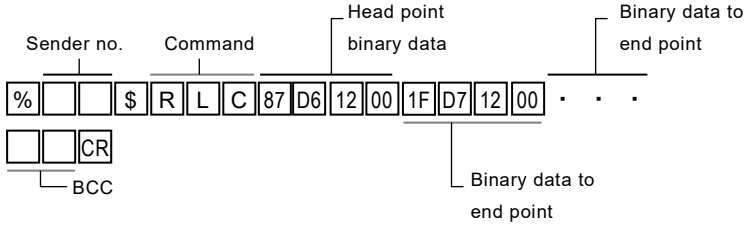

* Binary data on each point of response data is in 4 bytes in order of the lowest byte to highest byte. (Little endian)

Example)

Head point

87	D6	12	00
----	----	----	----

 → (Binary) 0x0012D687 = (Decimal) + 1234567

Second point

1F	D7	12	00
----	----	----	----

 → (Binary) 0x0012D71F → (Decimal) + 1234719

FORMAT 7 RS-422 Timing (or RS-422 Continuous)

4

Output Mode

The following dedicated command formats are used to output data if “RS-422 timing” or “RS-422 continuous” is selected in "3-3-8 COM Setting" - "Connection Mode".

Sensor transmission data

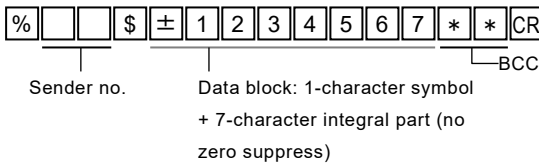

- RS-422 Timing

The measured value data when the timing input is turned ON will be output while the timing input is ON.

- RS-422 Continuous

Measured value data is output repeatedly in the above format on and after the RS-422 continuous output mode is selected.

■ Error Response

Error response data is common to all formats.

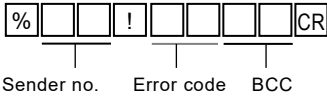

- Error code

Error code	Code type	Description
01	Command error	The command is undefined.
02	Address error	The start address is larger than the end address or the address is larger than 999999 when the RDD or WDD command is executed. The address length has not reached the prescribed length when the RDD or WDD command is executed.
03	Data error	The data length does not correspond to the command. The data length has not reached the prescribed length.
04	BCC error	BCC check was not conformable.
11	Communication error	A parity error occurred during data reception. A framing error occurred during data reception. An overrun error occurred during data reception.
21	Control flow error	The system is in setting mode.
22	Execution error	Calibration or analog scaling is not executable.
31	Buffering condition error 1	An attempt was made to make a buffering setting change without stopping buffering.
32	Buffering condition error 2	An attempt was made to start buffering with an inadequate buffering setting.
33	Buffering condition error 3	Data was read after buffering operation started. Data was read while the system was not in the accumulation completed status. Data in excess of the final data point was specified and read.

❗ CHECK

- If an abnormal response is received, check if there are any errors such as transmission data errors. Correct such errors, if any. If an error occurs regardless of the absence of mistakes, it may be a temporal phenomenon caused by noise or other external reasons or the external host device may have a system error. Turn the sensor head or system turned OFF and ON.

■ BCC

BCC is a horizontal parity check code used to improve the reliability of data communication. The exclusive OR is executed from the header (☐%) to final characters of communication data, and the exclusive OR in 8-bit data is converted to 2-character ASCII code. The sensor head is used to compare the exclusive OR from the header to final characters of the message received, and check if the exclusive OR coincides with the transmitted value of the PC. If the BCC at the time of transmission differs from that after reception, it indicates that some error has occurred in the message while in transmission.

In the case of omitting BCC calculation, accommodate ☐*☐* (2AH, 2AH) in the BCC. If data is transmitted with the BCC omitted, the BCC in the response data will be ☐*☐* (2AH, 2AH) as well.

BCC Creation Example

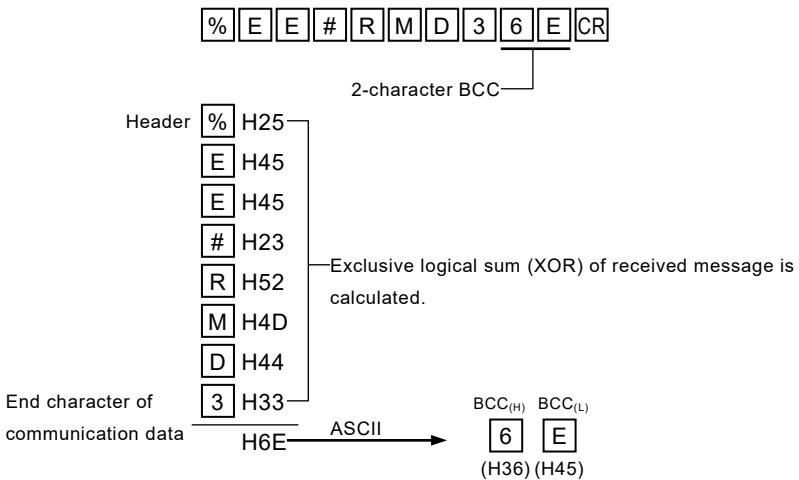

4-3 Command List

Basic Settings

Item		Command		Data	Description	Format
Basic Settings	Sampling Cycle	RSP	WSP	+00000	200 [μ s]	FORMAT 1
				+00001	500 [μ s]	
				+00002	1 [ms]	
				+00003	2 [ms]	
	Shutter Time	RFB	WFB	+00000 to +00031	+00000: Auto +00001 to +00031: Fixed	

*1. The data section consists of 5 digits (zero suppress is omitted) indicated in decimal.

Data Processing Settings

Item		Command		Data	Description	Format
Data Processing Settings	Average Times	RAV	WAV	+00000	Once	FORMAT 1
				+00001	4 times	
				+00002	16 times	
				+00003	64 times	
				+00004	256 times	
				+00005	1024 times	
	Analysis Mode	RHM	WHM	+00000	Normal measurement	
				+00001	Peak measurement	
				+00002	Valley measurement	
				+00003	Peak-to-peak measurement	
	Zero Set	RZS	WZS	+00000	OFF	
				+00001	ON	
	Zero Set Amount	RZV	—	-9500000 to +9500000	-950.0000 to +950.0000 [mm]	
Span	RMK	WMK	+01000 to +99999	+0.1000 to +9.9999	FORMAT 1	
Offset	RML	WML	-9500000 to +9500000	-950.0000 to +950.0000 [mm]	FORMAT 2	

*1. The data section consists of 5 digits (zero suppress is omitted) indicated in decimal.

■ Output Settings

Item		Command		Data	Description	Format	
Output Settings	Judgment Output Selection		ROD	WOD	+00000	Logic	FORMAT 1
					+00001	Independent	
					+00002	2-state	
					+00003	3-state	
	Displacement Judgment	Threshold a	RHA	WHA	-9500000 to +9500000	-950.0000 to +950.0000 [mm]	FORMAT 2
		Threshold b	RHB	WHB	-9500000 to +9500000	-950.0000 to +950.0000 [mm]	
		Hysteresis	RHH	WHH	+0000000 to +9500000	+000.0000 to +950.0000[mm]	
	Judgment Output OFF-delay		ROF	WOF	+00000	OFF	FORMAT 1
					+00001	2[ms]	
					+00002	4[ms]	
					+00003	10[ms]	
					+00004	20[ms]	
					+00005	40[ms]	
+00006					100[ms]		
+00007	Hold						
Measurement Value Display on Panel		RDS	WDS	+00000	FULL		
				+00001	SET 1		
				+00002	SET 2		

*1. The data section consists of 5 digits (zero suppress is omitted) indicated in decimal.

■ Analog Settings

Item		Command		Data	Description	Format	
Analog Settings	Analog Output Selection	RAS	WAS	+00000	Output current	FORMAT 1	
				+00001	Voltage output		
	Analog Scaling Measurement Value	A	RAL	WAL	-9500000 to +9500000	-950.0000 to +950.0000 [mm]	FORMAT 2
		B	RAH	WAH	-9500000 to +9500000	-950.0000 to +950.0000 [mm]	
	Analog Scaling Voltage	a	RVL	WVL	+00000 to +10000	+00.000 to +10.000 [V]	FORMAT 1
		b	RVH	WVH	+00000 to +10000	+00.000 to +10.000 [V]	
	Analog Scaling Current	a	RIL	WIL	+04000 to +20000	+04.000 to +20.000 [mA]	
		b	RIH	WIH	+04000 to +20000	+04.000 to +20.000 [mA]	

*1. The data section consists of 5 digits (zero suppress is omitted) indicated in decimal.

■ Alarm Settings

Item		Command		Data	Description	Format
Alarm Settings	Analog Output at Alarm	RAA	WAA	+00000	Hold	FORMAT 1
				+00001	Fixed value	
	Digital Output at Alarm	RAD	WAD	+00000	Hold	
				+00001	Fixed value	
	Alarm Delay Times	RHC	WHC	+00000 to +65535	+00000 to +65535 [times] (0: OFF, 65535: Previous normal value kept on hold)	

*1. The data section consists of 5 digits (zero suppress is omitted) indicated in decimal.

■ System Settings

Item	Command		Data	Description	Format	
System Setting	Memory Change	RMC	WMC	+00000	M0	FORMAT 1
				+00001	M1	
				+00002	M2	
				+00003	M3	
	Timing Mode	RTM	WTM	+00000	Hold	
				+00001	One shot	
	Laser Control	RLR	WLR	+00000	Stop	
				+00001	Emission	
	Eco Mode	RDP	WDP	+00000	Eco-OFF	
				+00001	Eco-ON	
				+00002	Eco-FULL	
	Initialize	-	WIN	+00000	None	
				+00001	Initialize	
	Save	-	WWR	+00000	None	
				+00001	Save	
	Timing	RTI	WTI	+00000	OFF	
+00001				ON		
Reset	RRS	WRS	+00000	OFF		
			+00001	ON		
Display Hold	RHD	WHD	+00000	OFF		
			+00001	ON		

*1. The data section consists of 5 digits (zero suppress is omitted) indicated in decimal.

■ Read Commands

Item		Command		Data	Description	Format
Read Command	Measurement Value Read	RMD	-	-9500000 to +9500000	-950.0000 to +950.0000[mm]	(FORMAT) 2
	Read Received Light Intensity	RID	-	+00000 to +04095	+00000 to +04095	(FORMAT) 1
	Alarm status	ROA	-	+00000	Alarm OFF	
				+00001	Measurement Alarm ON	
	OUT1 Terminal Read	RZA	-	+00000	OUT1 OFF	
				+00001	OUT1 ON	
	OUT2 Terminal Read	RZB	-	+00000	OUT2 OFF	
				+00001	OUT2 ON	
OUT3 Terminal Read	RZC	-	+00000	OUT3 OFF		
			+00001	OUT3 ON		
All Outputs Read	RMB	-	-	Measured value/Received light intensity /OUT1/OUT2/OUT3/AL	(FORMAT) 3	

*1. The data section consists of 5 digits (zero suppress is omitted) indicated in decimal.

■ Buffering Commands

Item		Command		Data	Description	Format
Buffering Command	Buffering Mode	RBD	WBD	+00000	Continuous	(FORMAT) 1
				+00001	Trigger	
	Buffering Rate	RBR	WBR	+00001 to +65535	+00001 to +65535	
	Accumulated Amount	RBC	WBC	+00001 to +03000	+00001 to +03000	
	Trigger Point	RTP	WTP	+00001 to +03000	+00001 to + accumulated amount	
	Trigger Delay	RTL	WTL	+00001 to +65536	+00000 to +65535	
	Trigger Conditions	RTR	WTR	+00000	At timing input ON	
				+00001	At or higher than threshold	
				+00002	Lower than threshold	
				+00003	At an alarm occurred	
+00004				At an alarm released		
Threshold	RBL	WBL	-9500000 to +9500000	-950.0000 to +950.0000[mm]	(FORMAT) 2	

Buffering Operation	RBS	WBS	+00000	Stop	FORMAT 1
			+00001	Start	
Status Readout	RTS	-	+00000	Non-buffering	
			+00001	Wait for Trigger	
			+00002	Accumulating	
			+00003	Accumulation Completed	
Last Data Point	RLD	-	+00001 to +03000	+00001 to accumulated amount	
Data Read (Normal)	RLA	-	-	5-character head point + 5-character end point Data point within the range from the head data point to the end data point is specified.	FORMAT 4
Data Read (Difference)	RLB	-	-	5-character head point + 5-character end point Data point within the range from the head data point to the end data point is specified.	FORMAT 5
Data Read (Binary)	RLC	-	-	5-character head point + 5-character end point Data point within the range from the head data point to the end data point is specified.	FORMAT 6

*1. The data section consists of 5 digits (zero suppress is omitted) indicated in decimal.

4-4 Setting Address List

In the case of connecting the sensor to our Programmable Logic Controller (PLC) or Programmable Display (GT Series), data can be exchanged by using data area write/read commands over MEWTOCOL-COM communications.

Our FP-series PLC is provided with data write (F145: Data send) and data read (F146: Data receive) commands. Programming is possible with ease without being aware of the command format of the NEWTOCOL-COM Communications if these commands are used.

For details, refer to the FP series Programming Manual.

❗ CHECK

In case using without protecting the following, the sensor may be operated unexpectedly. Thus, be sure to protect followings.

In case the unexpected operation is occurred, turn OFF the power and start up for initialization.

- Do not write and read an address not listed.
- Do not write to an unwritable address (NG in the list.)
- Do not write in a value other than specified data range to each address.

[MEWTOCOL-COM Communications]

When the sensor receives a command from the PLC or GT Series, the sensor will transmit a response to the command. The PLC and GT Series can exchange data with the sensor in the NEWTOCOL-COM communications procedure.

* NEWTOCOL-COM is a communications protocol developed for our FP-series PLC.

■ Command Formats(MEWTOCOL)

- Data Area Read

Request communication data

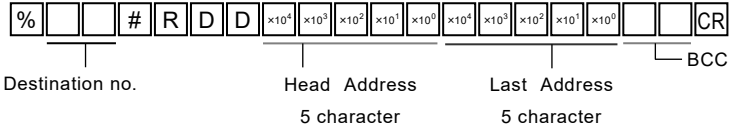

Normal response data

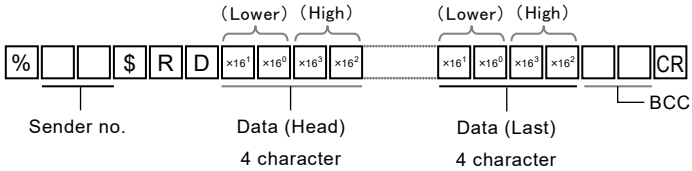

- Data Area Write

Request communication data

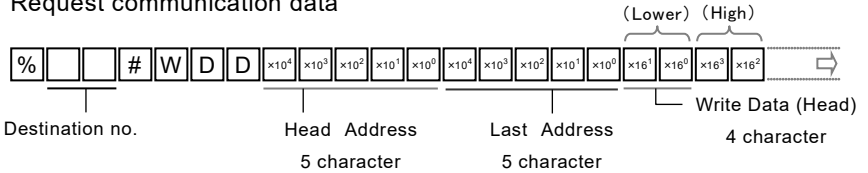

Normal response data

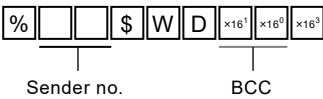
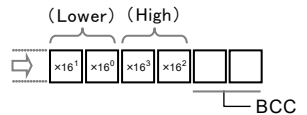

■ Error Response

Error response data is common to all formats.

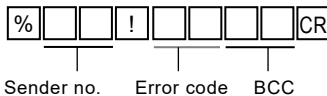

■ Sensing Settings

Address	Item	Data Range	Write	Read	Remarks
DT00050	Sampling Cycle	0~+3	OK	OK	
DT00051	Shutter Time	0~+31	OK	OK	

■ Data Processing Settings

Address	Item	Data Range	Write	Read	Remarks
DT00056	Average Times	0~+5	OK	OK	
DT00053	Analysis Mode	0~+3	OK	OK	
DT00061	Zero Set	0~+1	OK	OK	
DT00062	Zero Set Amount	(Lo)	NG	OK	Data type: 2 word
DT00063		(Hi)			
DT00057	Span	(Lo)	OK	OK	Data type: 2 word
DT00058		(Hi)			
DT00059	Offset	(Lo)	OK	OK	Data type: 2 word
DT00060		(Hi)			

■ Output Settings

Address	Item		Data Range	Write	Read	Remarks
DT00054	Judgment Selection	Output	0~+3	OK	OK	
DT00064	Displacement Judgment Threshold a	(Lo)	-9500000~ +9500000	OK	OK	Data type: 2 word
DT00065		(Hi)				
DT00066	Displacement Judgment Threshold b	(Lo)	-9500000~ +9500000	OK	OK	Data type: 2 word
DT00067		(Hi)				
DT00068	Displacement Judgment Hysteresis	(Lo)	+0000000~ +9500000	OK	OK	Data type: 2 word
DT00069		(Hi)				
DT00055	Judgment OFF-delay	Output	0~+7	OK	OK	
DT00088	Measurement Display on Panel	Value	0~+2	OK	OK	

■ Analog Settings

Address	Item		Data Range	Write	Read	Remarks
DT00070	Analog Selection	Output	0~+1	OK	OK	
DT00071	Analog Scaling Measureme nt Value A	(Lo)	-9500000~ +9500000	OK	OK	Data type: 2 word
DT00072		(Hi)				
DT00073	Analog Scaling Measureme nt Value B	(Lo)	-9500000~ +9500000	OK	OK	Data type: 2 word
DT00074		(Hi)				
DT00075	Analog Scaling Voltage a	(Lo)	-9500000~ +9500000	OK	OK	Data type: 2 word
DT00076		(Hi)				
DT00077	Analog Scaling Voltage b	(Lo)	-9500000~ +9500000	OK	OK	Data type: 2 word
DT00078		(Hi)				
DT00079	Analog Scaling Current a	(Lo)	-9500000~ +9500000	OK	OK	Data type: 2 word
DT00080		(Hi)				
DT00081	Analog Scaling Current b	(Lo)	-9500000~ +9500000	OK	OK	Data type: 2 word
DT00082		(Hi)				

■ Alarm Settings

Address	Item	Data Range	Write	Read	Remarks
DT00083	Analog Output at Alarm	0~+1	OK	OK	
DT00084	Digital Output at Alarm	0~+1	OK	OK	
DT00085	Alarm Delay Times	0~+65535	OK	OK	

■ System Settings

Address	Item	Data Range	Write	Read	Remarks
DT00104	Memory Change	0~+3	OK	OK	
DT00105	Timing Mode	0~+1	OK	OK	
DT00106	Laser Control	0~+1	OK	OK	
DT00107	Eco Mode	0~+2	OK	OK	
DT00108	Initialize	0~+1	OK	NG	
DT00109	Save	0~+1	OK	NG	
DT00111	Timing	0~+1	OK	OK	
DT00112	Reset	0~+1	OK	OK	

4

■ Data Readout

Address	Item	Data Range	Write	Read	Remarks
DT00400	Measurement Value Read	(Lo)	NG	OK	Data type: 2 word
DT00401		(Hi)			
DT00414	Read Received Light Intensity	0~+4095	NG	OK	
DT00410	Alarm status	0~+1	NG	OK	
DT00411	OUT1 Terminal Read	0~+1	NG	OK	
DT00412	OUT2 Terminal Read	0~+1	NG	OK	
DT00413	OUT3 Terminal Read	0~+1	NG	OK	

■ Buffering settings

Address	Item		Data Range	Write	Read	Remarks
DT01950	Buffering Mode		0~+1	OK	OK	
DT01951	Buffering Rate		+1~+65535	OK	OK	
DT01952	Accumulated Amount		+1~+3000	OK	OK	
DT01953	Trigger Point		+1~+3000	OK	OK	Settings within specified no. of the accumulated amount
DT01954	Trigger Delay		0~+65535	OK	OK	
DT01955	Trigger Conditions		0~+4	OK	OK	
DT01956	Trigger Conditions Threshold	(Lo)	-9500000~ +9500000	OK	OK	Data type: 2 word
DT01957		(Hi)				
DT01960	Buffering Operation		0~+1	OK	OK	
DT01959	Status Readout		0~+3	NG	OK	
DT01962	Last Data Point		0~+3000	NG	OK	
DT02000	Buffer Data No.1	(Lo)	-9500000~ +9500000	NG	OK	<ul style="list-style-type: none"> • Reading out data of up to last data point • Data type: 2 word
DT02001		(Hi)				
•	•	-9500000~ +9500000	NG	OK		
•	•					
•	•					
DT07998	Buffer Data No.3000	(Lo)	-9500000~ +9500000	NG	OK	
DT07999		(Hi)				

■ Setting for Programmable Display (GT Series)

For more details about these settings, refer to the User's Manual (dedicated Console Version).

Address	Item	Data Range		Write	Read	Remarks
DT00113	Display Hold	0	OFF	OK	OK	Hold DT00400/00401 measurements
		+1	ON			
DT00089	Display console measurement value	0	FULL	OK	OK	Reflecting to Measurements of DT00400/00401
		+1	Set 1			
		+2	Set 2			
		+3	Set 3			
DT00117	Backlight color display	0	White / Green	OK	OK	
		+1	OUT2ON red			
		+2	OUT2OFF red			
DT00119	Touch beep	0	ON	OK	OK	
		+1	OFF			

4

5

Troubleshooting

This Chapter provides information on the troubleshooting of the system.
Read this Chapter if something seems to be wrong with the system.

5-1 Corrective Actions ·····	5-2
5-2 Initialization ·····	5-6

5-1 Corrective Actions

If an error or trouble occurs during use of the system or a system failure is suspected, read this chapter carefully first and carry out the corresponding corrective actions.

Trouble type

- SET** Trouble in sensor head settings.
- COM** Trouble in communication control.
- MEAS** Trouble in the measurement method or display of measurement values.
- LED** Trouble in alarm or error LED indications.
- LASER** Trouble in laser emission.

❗ CHECK

- For the details of conditions where measurement value is unfixed, → refer to "2-5 Conditions When Output Data Become Unfixed".
- For problems related to memory saving and terminal settings, → refer to "3-3-2 Memory Change".

Type	Problem	Cause	Corrective action	Ref. page
SET	<ul style="list-style-type: none"> • The sensor head indicator does not light up. • The sensor head does not operate. 	The connecting cable is not connected properly.	Check the connection between the sensor head and connection cable.	1-2
		The connecting cable is disconnected.	Check the wiring between the connection cable and connector.	2-2
		Power is not supplied to the controller.	Check the connection between the 24-VDC external power and sensor head.	2-2
		The operation of the sensor head is stopped.	Turn ON the sensor head again.	3-6
		The eco mode is set to "Eco-FULL".	The LED will be lit by operating any switch. Make eco-mode settings if necessary.	3-40
LASER	The laser beam is not emitted.	The laser control setting is turned OFF and saved.	Save the laser control setting turned ON, otherwise the system will start with the laser beam turned OFF.	3-39 3-43
		Are the I/O wires bundled together? Is the multi-input turns ON due to contact between the purple wire and other wires?	I/O wires ends must be insulated to avoid contact between the I/O wires.	2-2

Type	Problem	Cause	Corrective action	Ref. page
MEAS	There is a difference between the actual distance to the measurement object and measurement value.	The measurement object is fluctuating or vibrating.	Stop the fluctuation or vibration of the measurement object.	1-8
		The measurement object is tilted.	Place the measurement object as perpendicularly as possible.	1-8
		The received light waveform is saturated or insufficient.	Adjust the received light intensity using the shutter time.	3-14
MEAS	The correct measurement value is not displayed.	The measurement object is out of the measurement range.	Check the measurement range of the sensor head used.	6-9
		The scaling is not set correctly.	Set the correct scaling.	3-29
		The light emitter/receiver is dirty.	Remove the dirt on the light emitter/receiver.	6 1-6
MEAS	Measurement values vary.	The moving average is small.	Increase the number of moving average.	3-16
		The light emitter/receiver is dirty.	Remove the dirt on the light emitter/receiver.	6 1-6
		The mounting direction of the sensor head is wrong.	Check the mounting direction of sensor head.	1-7
		The sensor head or measurement object is tilted.	Check the mounting of the sensor head and the setting position of the measurement object.	1-7
MEAS LED	The measurement value is not displayed, while "-----" remains displayed in the measurement value.	The measurement object is out of the measurement range.	Check the measurement range of the sensor head used.	6-9
		The timing input remains ON.	Set the timing input to OFF.	3-47
		The timing input is pink, and the NPN type / PNP type switching input is pink/purple. The wiring is not wired correctly.	Correctly wire the NPN type / PNP type switching input.	2-2
		Are the I/O wires bundled together? Is the multi-input turns ON due to contact between the purple wire and other wires?	I/O wires ends must be insulated to avoid contact between the I/O wires.	2-2
SET	The OUT indicator turns ON/OFF, however the output does not turn ON/OFF.	The NPN type / PNP type switching input is not wired correctly.	Correctly wire the NPN type / PNP type switching input, based on the output being used is either NPN or PNP.	2-2

Type	Problem	Cause	Corrective action	Ref. page
COM	RS-485 communication control cannot be done. Normal communication over RS-422/485 is impossible.	The wiring is incorrect.	RS-422 and RS-485 are different in wiring. Connect the wires correctly. Use a twisted-pair cable to ensure stable communication.	4-2 4-3 4-4
		The RS-422/485 connecting cable is disconnected.	Check the connection between RS-422/485 cable and connector.	4-2
		The wrong connection mode and baud rate are selected.	Connect the connection mode and baud rate correctly.	3-36
		The communications settings for the external equipment are wrong.	Check the settings for the external equipment (e.g., the communications board) and be sure to set the correct RS-422/485 communications specifications.	4-2
		The sensor number settings are wrong.	If a number of sensors are connected over RS-485, be sure to set a unique sensor number for each sensor.	3-35 4-4
		The selection of the terminating sensor is wrong.	Select the terminating resistor (R3) only for the terminating sensor head only. Be sure to turn OFF the terminating resistor of the rest of the sensor heads.	3-34
		The communication quality is degraded as a result of the wiring condition.	The communication condition may be improved by lowering the baud rate. The communication condition may be improved by selecting the R1 or R2 terminating resistor.	3-34 3-36
		Check that the correct Sending delay time is set.	In the case of connecting a number of units over RS-485, reception errors in the host device can be avoided by delaying the sensor's response time.	3-38
		An incorrect data format or command is transmitted.	Refer to the error codes and send the data with the correct format and command.	4-8 4-16
SET	The settings are wrong.	Several commands are sent continuously without waiting receiving responses from the controller.	Send the next command after the controller transmits the response to the previous command.	4-6
		The settings were not saved while RS-422/485 communication was used.	The execution of the Save command is required after making setting changes with the communications command (by using the Setting and Monitoring Software HL-G1SMI or the dedicated console. The set value will be discarded with the power turned OFF if the set value is not saved.	3-43

Type	Problem	Cause	Corrective action	Ref. page
<div style="border: 1px solid black; padding: 2px; display: inline-block;">MEAS</div> <div style="border: 1px solid black; padding: 2px; display: inline-block;">LED</div>	<p>The alarm indicator lights up and measurement cannot be done.</p> <p>↓</p> <p>If an alarm occurs, check the error code of alarm output read by RS-422/485 communication.</p>	The reflected beam from the beam emitting spot is blocked.	Move the position of the beam projection spot or change the mounting direction of the sensor head so the reflected beam should not be blocked.	1-9
		The beam emitting spot is applied to the R portion (curved surface) of the measurement object.	Apply the beam projection spot to the top of R portion or adjust the beam diameter so it comes larger by moving the measurement object back and forth within the measurement range.	1-8
		The reflected beam has directionality because the surface of the object is hairline-finished.	Check the mounting direction of sensor head.	1-7
		The received light intensity is insufficient because the sampling cycle is too short.	Set a longer sampling cycle or shutter time (when shutter time is set to a fixed value).	3-13 3-14
<div style="border: 1px solid black; padding: 2px; display: inline-block;">MEAS</div> <div style="border: 1px solid black; padding: 2px; display: inline-block;">LED</div>	The alarm indicator lights up and measurement cannot be done. The measurement range is limited.	The sampling cycle is too long and this causes excessive received light intensity beyond the adjustable range.	Set a shorter sampling cycle and reduce the emitted light intensity (enter a smaller number to the shutter time).	3-13 3-14

5-2 Initialization

- Initialization deletes all settings and returns them to the factory default settings.
- For more information, → refer to "3-3-10 Other System Settings - Initialization".
- After initialization, the default settings will not be saved if serial (RS-422/485) communication is used. To save the default settings after the power is turned OFF, → refer to "3-3-10 Other System Settings - Save".

6

Specifications

This Chapter provides the specifications of the sensor head.

6-1	Sensor Head Specifications	6-2
6-2	Dimensions	6-8
	▪ Sensor Head	6-8
6-3	Characteristics	6-15
	▪ Beam Diameter	6-15
	▪ Mutual Interference Area	6-15
	▪ Output Characteristics	6-20

Timing input	NPN operation: ON when connecting or connected to 0 V (depending on settings) PNP operation: ON when connecting or connected to positive terminal of external power supply (depending on settings)
Multiple input	Zero set, zero set OFF, reset, memory change, teaching, save, or laser control depending on input time. NPN operation: Depending on time to connect 0 V PNP operation: Depending on time to connect positive terminal of external power supply
Communications interface (Only High-function type)	RS-422 or RS-485 (switchable) Baud rate: 9,600/19,200/38,400/115,200/230,400/460,800/921,600 bps Data length: 8 bits, stop bit length: 1 bit, parity check: none, BCC: yes, end code: CR
Indicator	Laser radiation indicator Green LED ON at laser radiation
	Alarm indicator ON when measurement is impossible as a result of insufficient or excessive light quantity Orange LED
	Output indicator Yellow LED (No. of indicators: 3) ON at output
Digital display	Red LED for sign and 5-digit display
Protective structure	IP67
Pollution degree	2
Insulation resistance	20 MΩ min. at 250-VDC megger (between charged parts and casing)
Dielectric Withstand	1000 VAC for 1 min. (between charged parts and casing)
Vibration resistance	Endurance: 10 to 55 Hz (at 1-minute cycle), 1.5-mm double-amplitude two hours each in X, Y, and Z directions
Shock resistance	500m/s ² three times each in X, Y, and Z directions
Ambient illumination (*2)	3,000 lx max. (illumination level of light receiving surface under incandescent light)
Ambient temperature	-10°C to 45°C (No dew condensation or icing allowed), At storage: -20°C to +60°C
Ambient humidity	35 to 85%RH, At storage: 35 to 85%RH
Ambient height	2000 m or less
Material	Casing: PBT, Front cover: Acrylic, Cable: PVC
Cable length	Standard Type:5 m, High-function Type:0.5m
Cable extension (Only High-function type)	Extendable to 20 m with an optional extension cable (sold separately).
Mass	Standard Type:Approx. 70 g (without cable), approx. 320 g (including cable), and approx. 380 g (with packing) High-function Type:Approx. 70 g (without cable), approx. 110 g (including cable), and approx. 160 g (with packing)
Accessory	Laser warning label: 1 set
Applicable regulations	Compliant with EU Law: EMC Directive / British Legislation: EMC Regulation

The following measurement conditions are applied unless otherwise specified; power voltage: 24 VDC, ambient temperature: 20°C, sampling cycle: 500 μ s, average number of sampling times: 1024 times, measurement center distance, and measurement object: white ceramic.

- *1 The diameter is the size of the object at the measurement center distance and determined by $1/e^2$ (approximately 13.5%) of the center beam intensity. The reflectance around the detecting point may be higher than at the point due to leak light outside the specified area, and this may affect the measurement value.
- *2 Variance is $\pm 0.1\%$ F.S. or less depending on the ambient illuminance.

Multiple input		Zero set, zero set OFF, reset, memory change, teaching, save, or laser control depending on input time. NPN operation: Depending on time to connect 0 V PNP operation: Depending on time to connect positive terminal of external power supply
Communications interface (Only High-function type)		RS-422 or RS-485 (switchable) Baud rate: 9,600/19,200/38,400/115,200/230,400/460,800/921,600 bps Data length: 8 bits, stop bit length: 1 bit, parity check: none, BCC: yes, end code: CR
Indicator	Laser radiation indicator	Green LED ON at laser radiation
	Alarm indicator	Orange LED ON when measurement is impossible as a result of insufficient or excessive light quantity
	Output indicator	Yellow LED (No. of indicators: 3) ON at output
Digital display		Red LED for sign and 5-digit display
Protective structure		IP67
Pollution degree		2
Insulation resistance		20 M Ω min. at 250-VDC megger (between charged parts and casing)
Dielectric Withstand		1000 VAC for 1 min. (between charged parts and casing)
Vibration resistance		Endurance: 10 to 55 Hz (at 1-minute cycle), 1.5-mm double-amplitude two hours each in X, Y, and Z directions
Shock resistance		500m/s ² three times each in X, Y, and Z directions
Ambient illumination (*2)		3,000 lx max. (illumination level of light receiving surface under incandescent light)
Ambient temperature		-10°C to 45°C (No dew condensation or icing allowed), At storage: -20°C to +60°C
Ambient humidity		35 to 85%RH, At storage: 35 to 85%RH
Ambient height		2000 m or less
Material		Casing: PBT, Front cover: Acrylic, Cable: PVC
Cable length		Standard Type:5 m, High-function Type:0.5m
Cable extension (Only High-function type)		Extendable to 20 m with an optional extension cable (sold separately).
Mass		Standard Type:Approx. 70 g (without cable), approx. 320 g (including cable), and approx. 380 g (with packing) High-function Type:Approx. 70 g (without cable), approx. 110 g (including cable), and approx. 160 g (with packing)
Applicable regulations		Compliant with EU Law: EMC Directive / British Legislation: EMC Regulation

The following measurement conditions are applied unless otherwise specified; power voltage: 24 VDC, ambient temperature: 20°C, sampling cycle: 500 μ s, average number of sampling times: 1024 times, measurement center distance, and measurement object: aluminum vapor deposition surface reflection mirror.

- *1 The diameter is the size of the object at the measurement center distance and determined by $1/e^2$ (approximately 13.5%) of the center beam intensity. The reflectance around the detecting point may be higher than at the point due to leak light outside the specified area, and this may affect the measurement value.
- *2 Variance is $\pm 0.1\%$ F.S. or less depending on the ambient illuminance.

6-2 Dimensions

■ Sensor Head

- Diffuse reflection Standard Type (HL-G1□□-A-C5)

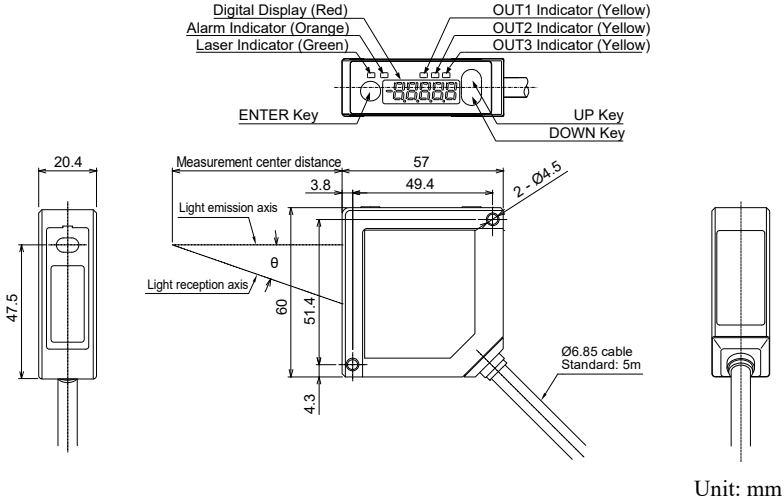

Model No.	Measurement center distance	θ
HL-G103-A-C5	30mm	30°
HL-G105-A-C5	50mm	21°
HL-G108-A-C5	85mm	15°
HL-G112-A-C5	120mm	11°
HL-G125-A-C5	250mm	6.2°

● Diffuse reflection High-function Type (HL-G1□□-S-J)

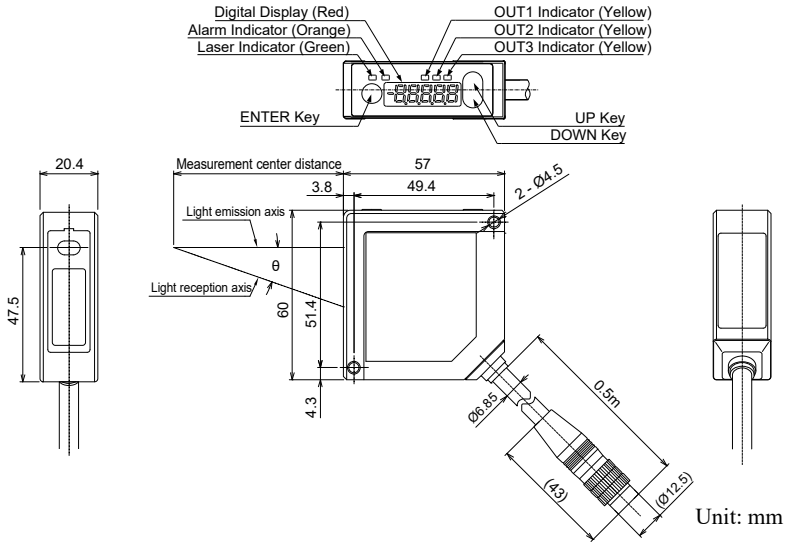

Model No.	Measurement center distance	θ
HL-G103-S-J	30mm	30°
HL-G105-S-J	50mm	21°
HL-G108-S-J	85mm	15°
HL-G112-S-J	120mm	11°
HL-G125-S-J	250mm	6.2°

● Specular reflection Standard Type (HL-G103A-RA-C5)

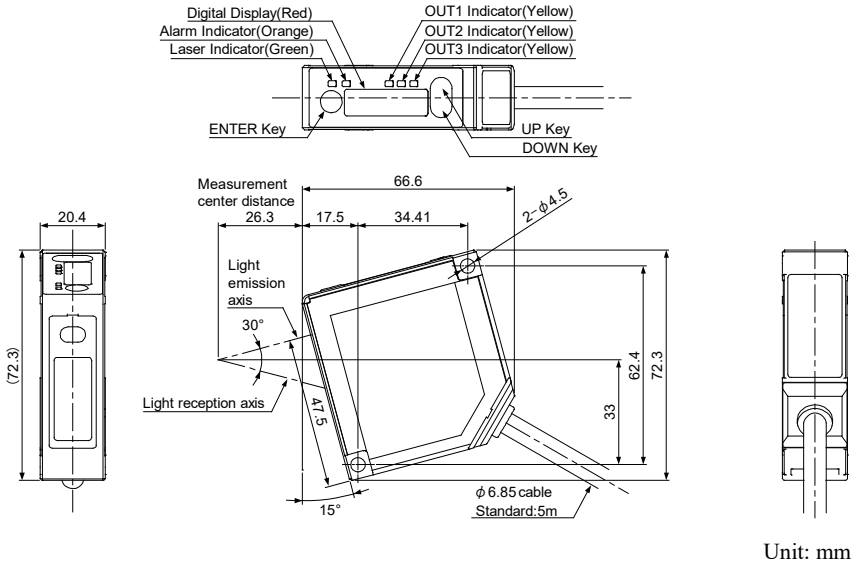

● Specular reflection High-function Type (HL-G103A-RS-J)

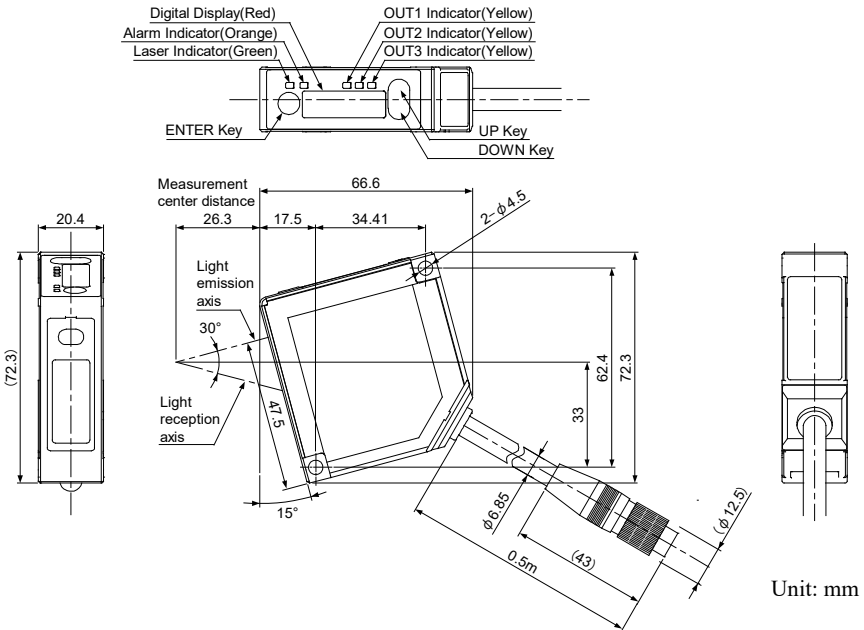

- Specular reflection Standard Type (HL-G105A-RA-C5)

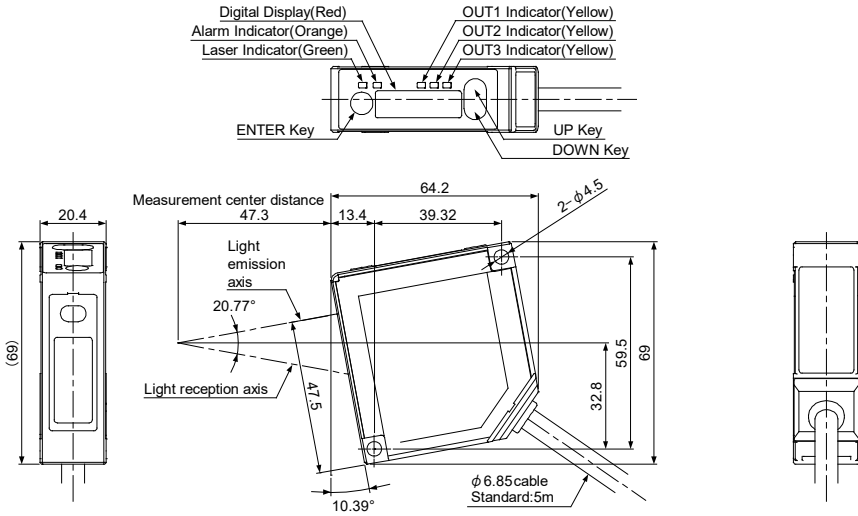

Unit: mm

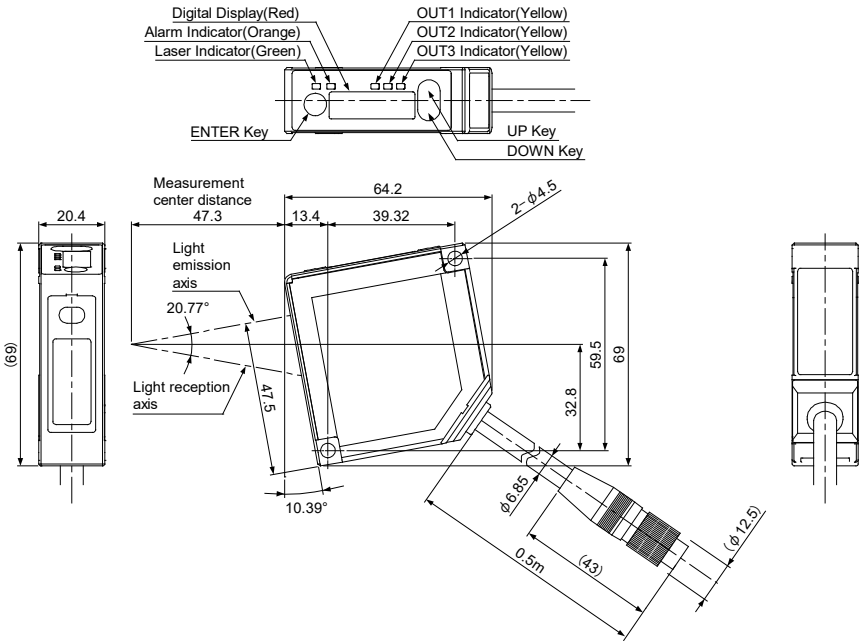

- Specular reflection High-function Type (HL-G105A-RS-J)

Unit: mm

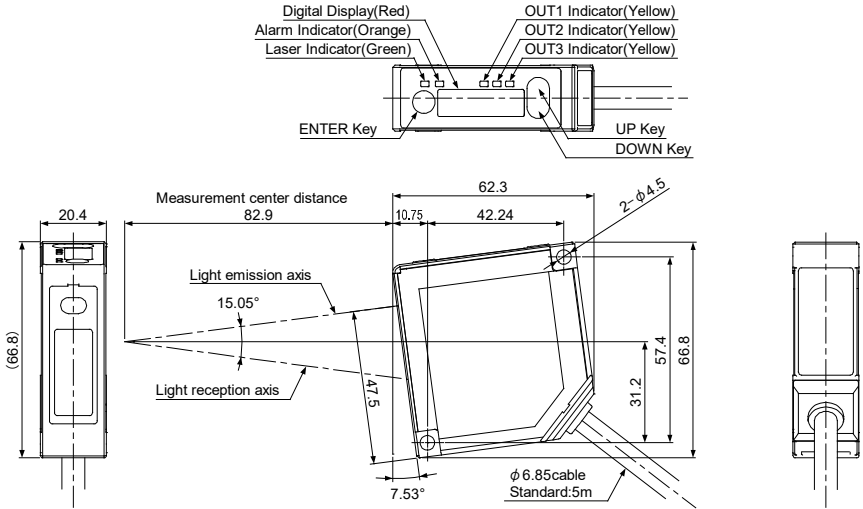

● Specular reflection Standard Type (HL-G108A-RA-C5)

Unit: mm

● diffuse reflection High-function Type (HL-G108A-RS-J)

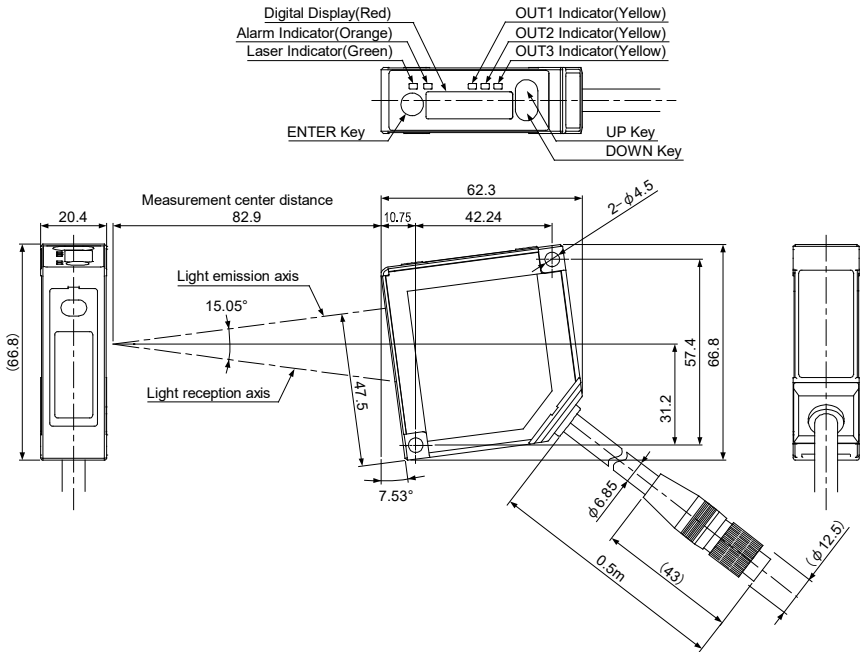

6

6-3 Characteristics

■ Beam Diameter

- Diffuse reflection type

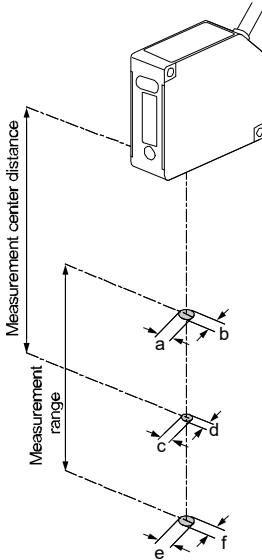

Model No.	Beam Diameter					
	a	b	c	d	e	f
HL-G103-S-J HL-G103-A-C5	0.15mm	0.15mm	0.1mm	0.1mm	0.15mm	0.15mm
HL-G105-S-J HL-G105-A-C5	1.2mm	0.6mm	1.0mm	0.5mm	0.9mm	0.4mm
HL-G108-S-J HL-G108-A-C5	1.5mm	0.9mm	1.25mm	0.75mm	1.0mm	0.6mm
HL-G112-S-J HL-G112-A-C5	1.8mm	1.2mm	1.5mm	1.0mm	0.8mm	0.5mm
HL-G125-S-J HL-G125-A-C5	2.5mm	1.5mm	3.5mm	1.75mm	4.5mm	2.0mm

●Specular reflection type

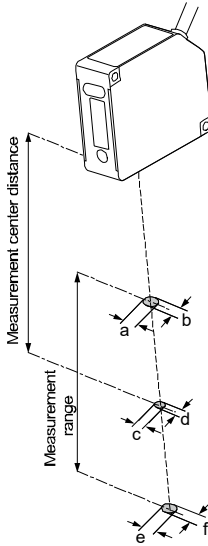

Model No.	Beam Diameter					
	a	b	c	d	e	f
HL-G103A-RS-J HL-G103A-RA-C5	0.15mm	0.15mm	0.1mm	0.1mm	0.15mm	0.15mm
HL-G105A-RS-J HL-G105A-RA-C5	0.15mm	0.15mm	0.1mm	0.1mm	0.15mm	0.15mm
HL-G108A-RS-J HL-G108A-RA-C5	0.2mm	0.2mm	0.2mm	0.2mm	0.2mm	0.2mm

■ Mutual Interference Area

In the case of installing two or more diffuse reflective sensor heads side by side, mutual interference will occur if the laser spots of the other sensor heads fall within the shaded area (▭) shown below. Install the sensor heads so that the laser spots of the other sensor heads will fall outside the shaded area (▭).

- 30-mm Type (HL-G103-A-C5/HL-G103-S-J)

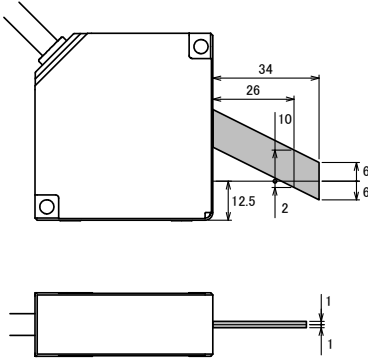

Unit: mm

- 50-mm Type (HL-G105-A-C5/HL-G105-S-J)

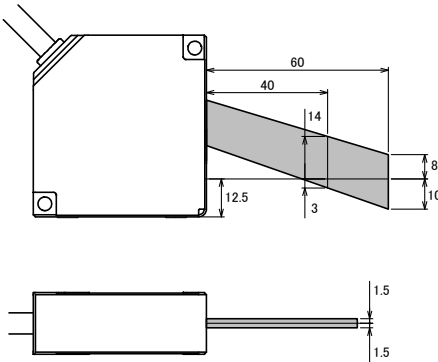

Unit: mm

● 85-mm Type (HL-G108-A-C5/HL-G108-S-J)

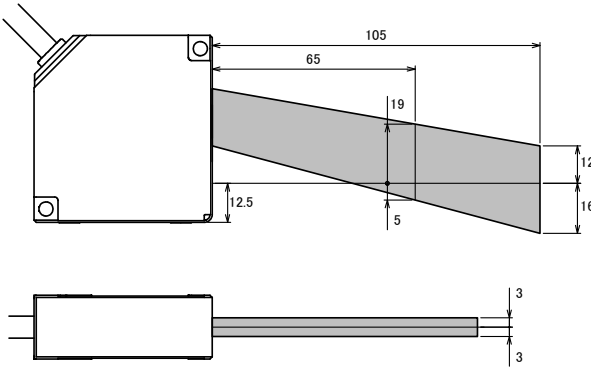

Unit: mm

● 120-mm Type (HL-G112-A-C5/HL-G112-S-J)

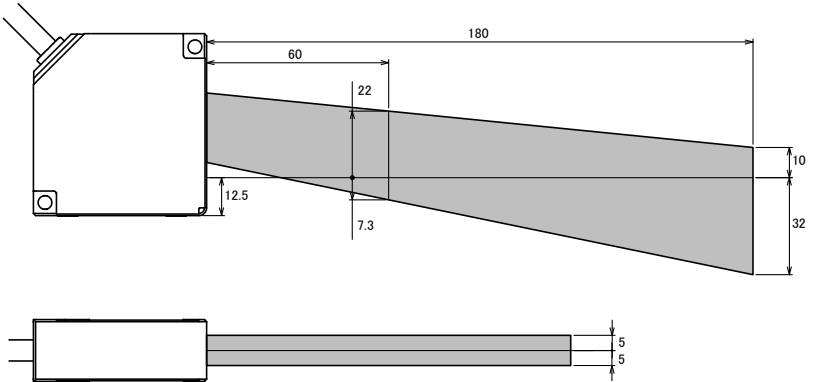

Unit: mm

6

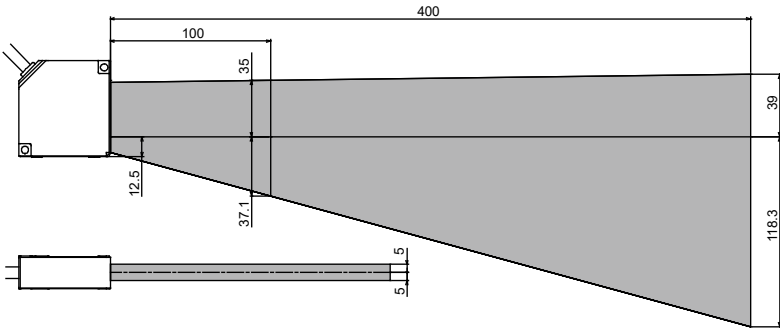

- 250-mm Type (HL-G125-A-C5/HL-G125-S-J)

Unit: mm

■ Output Characteristics

- Diffuse reflection type

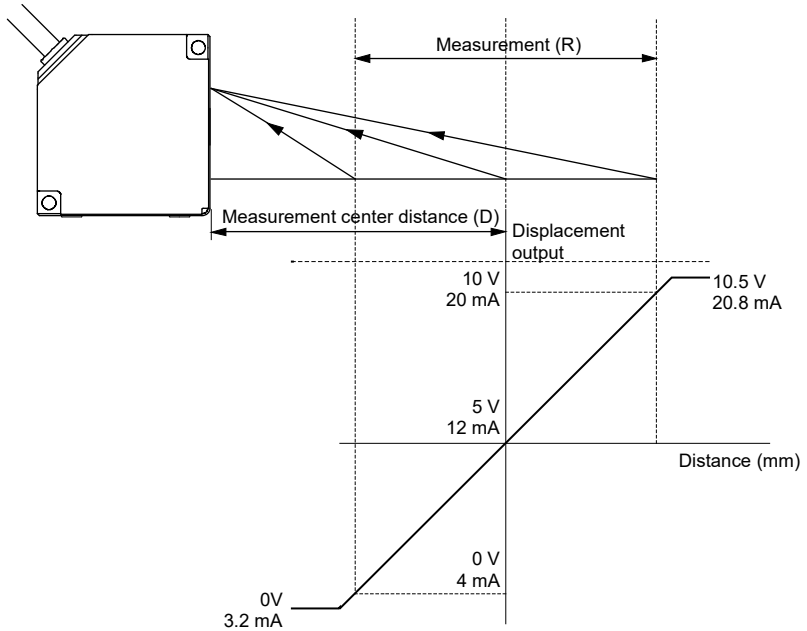

*1 In the figure above, analog output setting is used as the initial setting.

6

	Standard type	High-function type	Measurement center distance (D)	Measurement method (R)
30-mm type	HL-G103-A-C5	HL-G103-S-J	30 mm	±4 mm
50-mm type	HL-G105-A-C5	HL-G105-S-J	50 mm	±10 mm
85-mm type	HL-G108-A-C5	HL-G108-S-J	85 mm	±20 mm
120-mm type	HL-G112-A-C5	HL-G112-S-J	120 mm	±60 mm
250-mm type	HL-G125-A-C5	HL-G125-S-J	250 mm	±150 mm

- Specular reflection type

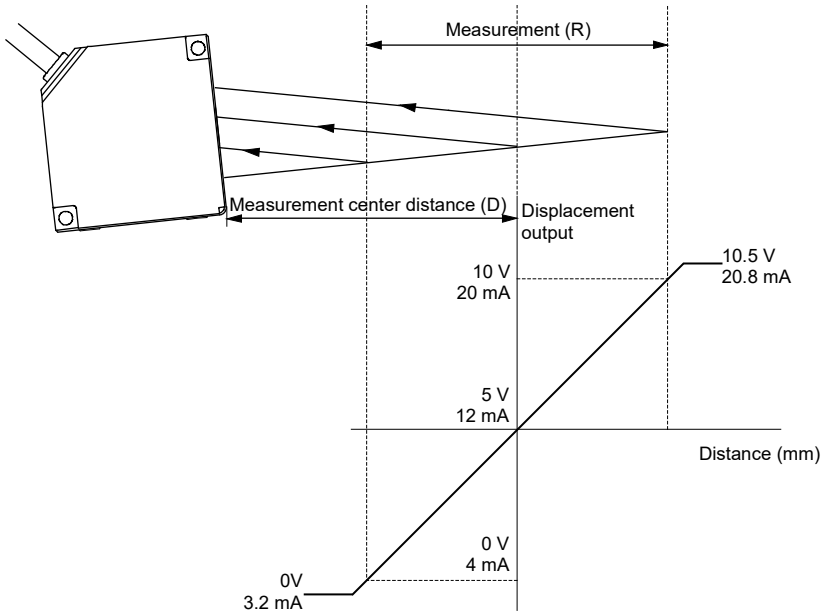

*1 In the figure above, analog output setting is used as the initial setting.

	Standard type	High-function type	Measurement center distance (D)	Measurement method (R)
30-mm type	HL-G103A-RA-C5	HL-G103A-RS-J	26.3 mm	±2 mm
50-mm type	HL-G105A-RA-C5	HL-G105A-RS-J	47.3 mm	±5 mm
85-mm type	HL-G108A-RA-C5	HL-G108A-RS-J	82.9 mm	±10 mm

Revision history

Released date	Revision no.	Details of revision
October 2010	A first release	
January 2011	The 1st edition	
March 2011	The 2nd edition	
January 2012	The 3rd edition	
March 2013	The 4th edition	
September 2013	The 5th edition	
December 2013	The 6th edition	
October 2014	The 7th edition	
January 2015	The 8th edition	
June 2016	The 9th edition	
July 2016	The 10th edition	
May 2017	The 11th edition	
October 2019	The 12th edition	
September 2021	The 13th edition	
July 2022	The 14th edition	Addition of a precaution to the Maintenance and Inspection section.
December 2022	The 15th edition	Addition of note regarding UKCA
April 2024	The 16th edition	Made revisions in line with the change of the company name.

Panasonic Industry Co., Ltd.

1006, Oaza Kadoma, Kadoma-shi, Osaka 571-8506, Japan
<https://industry.panasonic.com/>

Please visit our website for inquiries and about our sales network.

© Panasonic Industry Co., Ltd. 2010-2024

April, 2024

WUME-HLG1-16