

PROGRAMMABLE DISPLAY

GT Series

MODBUS(RTU mode) Slave

Manual

Table of contents

- 1.1 MODBUS(RTU mode) Slave..... 1**
 - 1.1.1 Operable Programmable Displays 1
 - 1.1.2 Communication Condition..... 1
 - 1.1.3 Internal Memory Configuration..... 1
 - 1.1.4 Overview of Modbus RTU Communication..... 2

- 1.2 Basic Format..... 3**

- 1.3 Function Code Reference 5**
 - 1.3.1 Function Code 1: Read Internal Relay Status 5
 - 1.3.2 Function Code 3: Read Data Registers 6
 - 1.3.3 Function Code 4: Read Data Registers 7
 - 1.3.4 Function Code 5: Write to Single Internal Relay..... 8
 - 1.3.5 Function Code 6: Write One Word to Data Registers 9
 - 1.3.6 Function Code 15: Write to Multiple Internal Relays..... 10
 - 1.3.7 Function Code 16: Write to Multiple Data Registers..... 11

- 1.4 How to Calculate CRC-16..... 12**

- 1.5 Connection Diagrams..... 13**
 - 1.5.1 Precautions when connecting GT 13
 - 1.5.2 RS232C..... 13
 - 1.5.3 RS422 14
 - 1.5.4 RS485 15

WGR

WGR is a device (memory) area that is convenient to be used for the data treated in bit unit, and it is called “internal relay”.

The device size is 0000 to 0255.

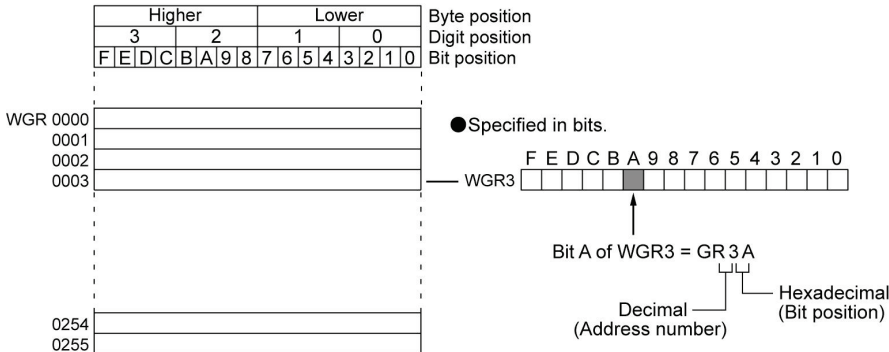

Clock data storage devices (GDT9080 to GDT9086)

The data of the clock built in the GT is stored in the data registers GDT9080 to GDT9086. The data can be read by using the readout command of the data registers.

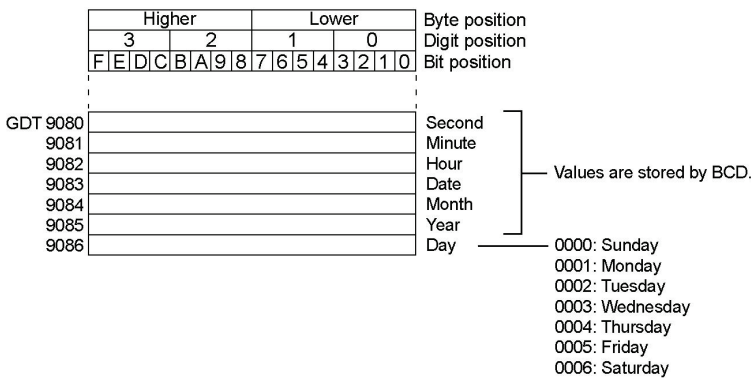

Note:

- The built-in clock in the GT cannot be adjusted from the external device. Change the mode of the GT to the setting mode and select “Clock” from the menu to adjust the time.



Reference: For the detailed procedure, refer to <GT Series Technical Manual>.

- The clock function is not available for the models that a battery cannot be installed.
- The values of era name stored in GDT9085 are the last two digits of the year.

1.1.4 Overview of Modbus RTU Communication

Modbus protocol is to send back a response to an external device from the GT once a command is sent to the GT from the external device. The GT always return a response once it has received a command. If a response has not been sent, check if the connection of the communication cable and communication conditions are correct, or check if a correct command was sent.

There are ASCII mode and RTU(binary) mode in Modbus protocol, however, the GT series supports the RTU(binary) mode only.

1.2 Basic Format

The formats of a command to be sent to the GT from an external device and a response to be returned from the GT are as follows. Also, the maximum length of the command and response supported by GT is 512 bytes.

Command

GT unit No.	Function code	Data	Error check
-------------	---------------	------	-------------

Response

GT unit No.	Function code	Data	Error check
-------------	---------------	------	-------------

GT unit No.

Specify the unit number from 1 to 247 set for the GT. External devices can communicate with only one GT simultaneously.

For some function codes, "0" can be specified as a slave address. In that case (broadcast mode), commands can be received regardless of specified numbers. However, no response will be returned.

Function code

As for external devices, the functions to be executed are specified with function codes. Function codes supported by the GT are as follows.

Function code	Function	Availability of broadcast
01	Read internal relay status	
03	Read data registers	
04	Read data registers	
05	Write to single internal relay	<input type="radio"/>
06	Write one word to data register	<input type="radio"/>
15	Write to multiple internal relays	<input type="radio"/>
16	Write to multiple data registers	<input type="radio"/>

*When executing the broadcast, allow enough time for sending the next command.

Data

The data required for executing commands is sent. Required data varies according to function codes.

Error check

The error check is performed by CRC-16 (cyclic redundancy check).

Response If Something Unusual Occurs

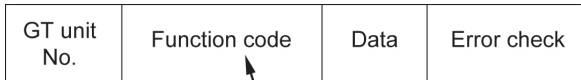

Function code + 80H

If there is an error in the transmitted data message, the GT will not execute any operation and will return the above message.

Checking the function code of the response message on an external device enables to confirm whether or not the transmitted data was correct. When an error occurred, the cause can be determined by checking the error code.

Error code	Cause of error
01	The function code is abnormal. (Nonexistent function code is transmitted.)
02	The address of internal relay and data register is abnormal. (Out of the range)
03	The quantity of internal relay and data register is abnormal. (Out of the range) The number of specified data is different from the number of transmitted data. With the 05 command, the data is other than 0x0000 or 0xFF00. The number of specified read data exceeds 512 bytes of the maximum number of response.

No response

The GT does not send responses ignoring commands in the following cases. Also, when the slave address is "0" with a writing function, the GT does not send responses.

- (1) When a transmission error (any of the overrun, framing, parity, CRC-16) was detected in a command
- (2) When the address of a command does not match with the GT unit number.
- (3) When the time interval between the data that make up a command is long. When the interval between data is 24-bit time or more.

1.3 Function Code Reference

In the Modbus (RTU) mode, allow 4-character time or more for the interval between messages.

1.3.1 Function Code 1: Read Internal Relay Status

Command

GT unit No.	Function code 01(H)	Starting No. (Higher)	Starting No. (Lower)	No. of read (Higher)	No. of read (Lower)	Error check (Higher)	Error check (Lower)
1byte	1byte	1byte	1byte	1byte	1byte	1byte	1byte

Response

GT unit No.	Function code 01(H)	No. of data (Bytes)	Data 1	-----	Data n	Error check (Higher)	Error check (Lower)
1byte	1byte	1byte	1byte		1byte	1byte	1byte

GT unit No. Specify the GT unit number that a command will be sent in binary.
In case of 20, specify 14(H).

Function code Specify 01(H).

Starting No. Specify the first internal relay number to be read in hexadecimal.
In case of GR20, specify 00(H) and 20(H).

No. of read Specify the number of internal relays to be read in hexadecimal.
In case of 37, specify 00(H) and 25(H).

A maximum of 2040 can be specified. (Specify 07(H) and F8(H).)

No. of data The number of bytes from data 1 to data “n” is sent back.

Data 1 to n The on/off-state is sent back from the status of the first internal relay in 8-bit unit.
The LSB of data 1 is the first internal relay state. Since it is returned in 8-bit unit, the bits for the internal relays of data “n” that do not correspond will be returned as 0.

Error check The values of CRC-16 are sent/received.

1.3.2 Function Code 3: Read Data Registers

Command

GT unit No.	Function code 03(H)	Starting No. (Higher)	Starting No. (Lower)	No. of read (Higher)	No. of read (Lower)	Error check (Higher)	Error check (Lower)
1byte	1byte	1byte	1byte	1byte	1byte	1byte	1byte

Response

GT unit No.	Function code 03(H)	No. of data (Bytes)	Data 1 (Higher)	Data 1 (Lower)	-----	Data n (Higher)	Data n (Lower)
1byte	1byte	1byte	1byte	1byte		1byte	1byte

Error check (Higher)	Error check (Lower)
1byte	1byte

- GT unit No.** Specify the GT unit number that a command will be sent in binary. In case of 20, specify 14(H).
- Function code** Specify 03(H).
- Starting No.** Specify the first data register number to be read in hexadecimal. In case of GDT108, specify 00(H) and 6C(H).
- No. of read** Specify the number of data registers to be read in hexadecimal. In case of 5, specify 00(H) and 05(H).
A maximum of 127 can be specified. (Specify 00(H) and 7F(H).)
- No. of data** The number of data from data 1 to data “n” is sent back in bytes.
- Data 1 to n** The content of the first data register is sent back for the specified number of read in the order of the higher bytes and lower bytes.
- Error check** The values of CRC-16 are sent/received.

1.3.3 Function Code 4: Read Data Registers

Command

GT unit No.	Function code 04(H)	Starting No. (Higher)	Starting No. (Lower)	No. of read (Higher)	No. of read (Lower)	Error check (Higher)	Error check (Lower)
1byte	1byte	1byte	1byte	1byte	1byte	1byte	1byte

Response

GT unit No.	Function code 04(H)	No. of data (Bytes)	Data 1 (Higher)	Data 1 (Lower)	-----	Data n (Higher)	Data n (Lower)
1byte	1byte	1byte	1byte	1byte		1byte	1byte

Error check (Higher)	Error check (Lower)
1byte	1byte

- GT unit No.** Specify the GT unit number that a command will be sent in binary. In case of 20, specify 14(H).
- Function code** Specify 04(H).
- Starting No.** Specify the first data register number to be read in hexadecimal. In case of GDT108, specify 00(H) and 6C(H).
- No. of read** Specify the number of data registers to be read in hexadecimal. In case of 5, specify 00(H) and 05(H).
A maximum of 127 can be specified. (Specify 00(H) and 7F(H).)
- No. of data** The number of data from data 1 to data “n” is sent back in bytes.
- Data 1 to n** The content of the first data register is sent back for the specified number of read in the order of the higher bytes and lower bytes.
- Error check** The values of CRC-16 are sent/received.

1.3.4 Function Code 5: Write to Single Internal Relay

Command

GT unit No.	Function code 05(H)	Relay no. (Higher)	Relay no. (Lower)	Specified data (Higher)	Specified data (Lower)	Error check (Higher)	Error check (Lower)
1byte	1byte	1byte	1byte	1byte	1byte	1byte	1byte

Response

GT unit No.	Function code 05(H)	Relay no. (Higher)	Relay no. (Lower)	Specified data (Higher)	Specified data (Lower)	Error check (Higher)	Error check (Lower)
1byte	1byte	1byte	1byte	1byte	1byte	1byte	1byte

GT unit No. Specify the GT unit number that a command will be sent in binary.
In case of 20, specify 14(H).

Function code Specify 05(H).

Relay no. Specify the first relay number to be written in hexadecimal.
In case of GR173, specify 01(H) and 13(H).

Specified data Specify FF(H) (Higher) and 00(H) (Lower) for specifying ON.
Specify 00(H) and 00(H) for specifying OFF.

Error check The values of CRC-16 are sent/received.

The response is the same message as the command.

1.3.5 Function Code 6: Write One Word to Data Registers

Command

GT unit No.	Function code 04(H)	Data register No. (Higher)	Data register No. (Lower)	Write data (Higher)	Write data (Lower)
1byte	1byte	1byte	1byte	1byte	1byte

Error check (Higher)	Error check (Lower)
1byte	1byte

Response

GT unit No.	Function code 04(H)	Data register No. (Higher)	Data register No. (Lower)	Write data (Higher)	Write data (Lower)
1byte	1byte	1byte	1byte	1byte	1byte

Error check (Higher)	Error check (Lower)
1byte	1byte

- GT unit No.** Specify the GT unit number that a command will be sent in binary. In case of 20, specify with 14(H).
- Function code** Specify 06(H).
- Data register No.** Specify the data register number to be written in hexadecimal. In case of GDT510, specify 01(H) and FE(H).
- Write data** The values to be written are sent in order of the higher and lower values. If you want to write 1234(H), specify 12(H) and 34(H).
- Error check** The values of CRC-16 are sent/received.

The response is the same message as the command.

1.3.6 Function Code 15: Write to Multiple Internal Relays

Command

GT unit No.	Function code 0F(H)	Starting relay No. (Higher)	Starting relay No. (Lower)	No. of write relay (Higher)	No. of write relay (Lower)
1byte	1byte	1byte	1byte	1byte	1byte

No. of data (Bytes)	Data 1	-----	Data n	Error check (Higher)	Error check (Lower)
1byte	1byte		1byte	1byte	1byte

Response

GT unit No.	Function code 0F(H)	Starting relay No. (Higher)	Starting relay No. (Lower)	No. of write relay (Higher)	No. of write relay (Lower)
1byte	1byte	1byte	1byte	1byte	1byte

Error check (Higher)	Error check (Lower)
1byte	1byte

- GT unit No.** Specify the GT unit number that a command will be sent in binary. In case of 20, specify with 14(H).
- Function code** Specify 0F(H).
- Starting relay No.** Specify the first number of the internal relay to be written in hexadecimal. In case of GR12F, specify 00(H) and CF(H).
- No. of write relay** The number of internal relays to be written is sent in order of the higher and lower values. Specify 00(H) and 14(H) for writing 20 relays.
- No. of data** The number of data from data 1 to data "n" is specified.
- Data 1 to n** The on/off-state is sent from the first internal relay in 8-bit unit. The LSB of data 1 is the first internal relay state. Since it is returned in 8-bit unit, the bits for the internal relays of data "n" that do not correspond will be returned as 0.
- Error check** The values of CRC-16 are sent/received

The response is the message that excludes the number of data until the data "n" from the command.

1.3.7 Function Code 16: Write to Multiple Data Registers

Command

GT unit No.	Function code 10(H)	Starting No. (Higher)	Starting No. (Lower)	No. of write register (Higher)	No. of write register (Lower)
1byte	1byte	1byte	1byte	1byte	1byte

No. of data (Bytes)	Data 1 (Higher)	Data 1 (Lower)	-----	Data n (Higher)	Data n (Lower)	Error check (Higher)	Error check (Lower)
1byte	1byte	1byte		1byte	1byte	1byte	1byte

Response

GT unit No.	Function code 10(H)	Starting No. (Higher)	Starting No. (Lower)	No. of write register (Higher)	No. of write register (Lower)
1byte	1byte	1byte	1byte	1byte	1byte

Error check (Higher)	Error check (Lower)
1byte	1byte

- GT unit No.** Specify the GT unit number that a command will be sent in binary. In case of 20, specify with 14(H).
- Function code** Specify 10(H).
- Starting No.** Specify the first number of data registers to be written in hexadecimal. In case of GDT1230, specify 04(H) and CE(H).
- No. of write registers** The number of data registers to be written is sent in order of the higher and lower values. Specify 00(H) and 14(H) for writing 20 registers.
- No. of data** The number of data from data 1 to data n is specified.
- Data 1 to n** The data to be written is sent from the first data register in order of the higher and lower values.
- Error check** The values of CRC-16 are sent/received.

The response is the message that excludes the number of data until the data "n" from the command.

1.4 How to Calculate CRC-16

Calculate CRC-16 (cyclic redundancy check) from the slave address to the end of data, and set the calculated 16-bit data after the data in order of the lower and higher data. CRC divides the information that should be sent by generating polynomial, and sends the information with the remainder added at the end. (Generating polynomial: $X^{16}+X^{15}+X^2+1$)

- (1) Initialize the data of CRC-16 (hereinafter referred to as X). (Set FFFF(H).)
- (2) Calculate exclusive OR (XOR) of the first data and X, and assign it to X.
- (3) Shift X to the right for 1 bit, and assign it to X.
- (4) If carries are generated as a result of the shift, calculate XOR using the result of (3) and a constant A001(H) and assign it to X.
If carries are not generated, proceed to (5).
- (5) Repeat (3) and (4) until shifting X 8 times.
- (6) Exclusive OR (XOR) of the next data and X is calculated and assigned to X.
- (7) Repeat (3) to (5).
- (8) Repeat (3) to (5) up to the last data.
- (9) Set X as CRC-16 at the end of message data in order of the lower and higher values.

1.5 Connection Diagrams

1.5.1 Precautions when connecting GT

-If noise is a problem, use a shielded cable and employ countermeasures such as installing a ferrite core if necessary. Also take measures so that the shielding doesn't peel off and noise such as static electricity does not interfere.

-The number of units, transmission distance and baud rate may differ depending on the device connected. Verify with the device being used.

-The maximum cable length for RS232C type is 15 m, also RS422 (5 V) type is 30 m.

-The maximum transmission distance is 500 m for the 24 V RS422 type.

-When connecting to the RS485, it may not be connected depending on the timing for switching between the transmission and reception at the external device. Please check it using the actual equipment. The terminal unit setting varies according to the external device to be connected. Confirm it before setting a terminal unit.

1.5.2 RS232C

- GT01

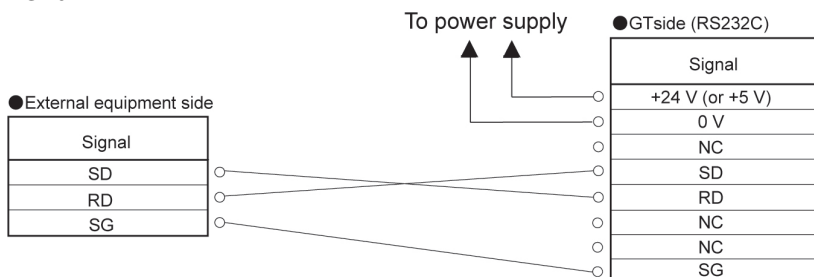

- When not performing RS/CS control (except GT01)

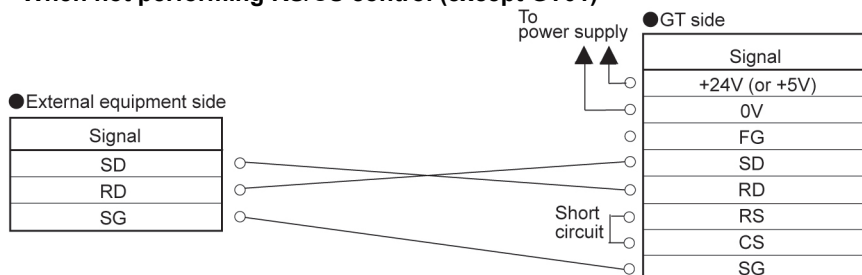

Note) The RS/CS at the GT side should be short-circuited. However, short-circuiting is not required when setting "CS/RS Control" to "Off" in the "Communication Parameter" tab in the GTWIN "GT Configuration" dialog box.

- When performing RS/CS control (except GT01)

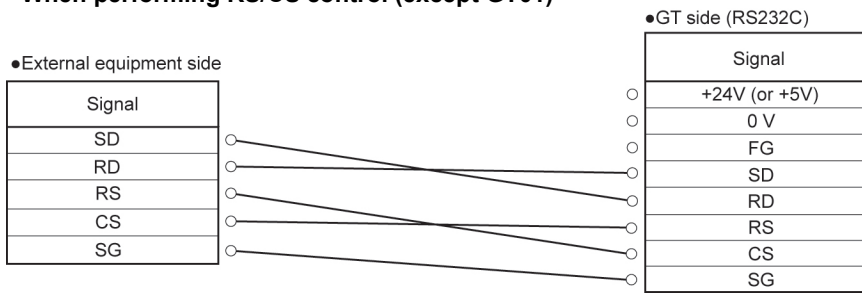

1.5.3 RS422

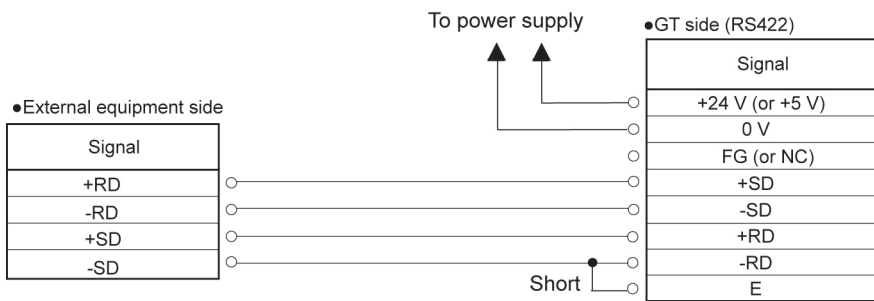

1.5.4 RS485

- 1:1 connection

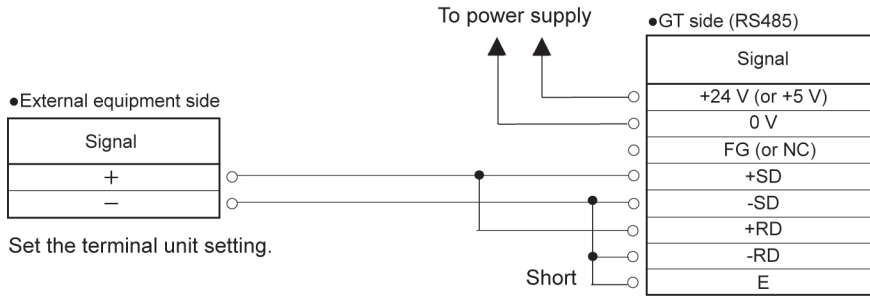

- When connecting more than one GT

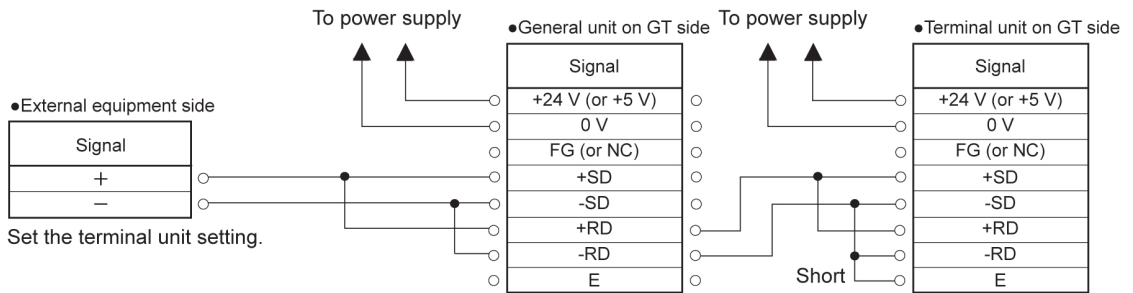

* Wiring should extend from one unit to the next.
Never run two wires from a single unit to two other units.

• Correct wiring

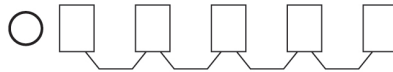

• Incorrect wiring

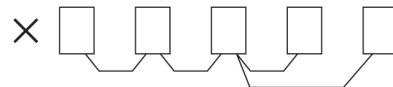

Record of changes

Manual No.	Date	Description of changes
ARCT1F501E	JUL.2009	1st Edition
ARCT1F501E-1	FEB.2010	2nd Edition
ARCT1F501E-2	JUL.2010	3rd Edition Additions: GT02
ARCT1F501E-3	DEC.2010	4th Edition Additions: GT02L
ARCT1F501E-4	AUG.2011	5th Edition Additions: GT32-E
ARCT1F501E-5	JUL.2013	6th Edition Additions: GT03-E
WUME-GTMODBUS-01	APR.2024	7th Edition Change in Corporate name

Panasonic Industry Co., Ltd.

1006, Oaza Kadoma, Kadoma-shi, Osaka 571-8506, Japan
<https://industry.panasonic.com/>

Please visit our website for inquiries and about our sales network.

© Panasonic Industry Co., Ltd. 2009-2024

April, 2024

WUME-GTMOBUS-01