

Thank you very much for using our products. Please read this Instruction Manual carefully and thoroughly for the correct and optimum use of this product. Kindly keep this manual in a convenient place for quick reference.

- For the details of High-speed · high-accuracy eddy current digital displacement sensor **GP-X** series, refer to the **GP-X** series user's manual.
- This product has been developed / produced for industrial use only.

## 1 MAJOR SPECIFICATIONS

Designation	BCD output unit	Controller communication unit
Item	GP-XBCD	GP-XCOM
Power supply	Supplied from controller (GP-XC□) (Note)	
Current consumption	20mA or less	5mA or less
Output (5-digit BCD output Polarity indication output VALID output)	N channel MOS FET open drain · Maximum sink current: 50mA · Applied voltage: 30V DC or less (between output and GND) · Residual voltage: 1V or less (at 50mA sink current)	—
Input (Hold input)	Non-voltage contact or NPN open-collector transistor Low (0 to 1V) : Valid, High (open) : Invalid	—
Switch	—	Terminator ON/OFF switch
Material	Enclosure : ABS	
Weight	30g approx.	20g approx.
Accessory	Mounting bracket [stainless steel (SUS304)] : 1 pc.	
Connection cable (optional)	GP-XBCC3 (Exclusive cable 3m)	SL-F150 (Cable length 150mm) SL-F250 (Cable length 250mm) SL-F1000 (Cable length 1,000mm)

Note: When the controller communication unit (GP-XCOM) is used, and a different power supply is used for the 2, or more, controllers, be sure to connect either +V lines or 0V lines of the controllers each other.

## 2 PART DESCRIPTION

### GP-XBCD

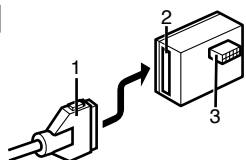

No.	Description	Function
1	Cable with connector on one end for BCD output unit (optional)	Connect the BCD output unit.
2	Connector for BCD output	Connect the cable with connector on one end for BCD output unit.
3	Connector for connecting the controller	Connect with the side panel of the controller.

Notes: 1) To use the BCD output unit, make sure to configure the BCD output. For the setting method, refer to the **GP-X** series user's manual.

2) After the controller is configured for BCD output, the analog voltage output becomes invalid.

### GP-XCOM

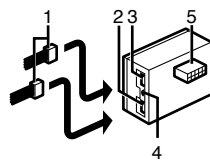

No.	Description	Function
1	Link cable (optional)	Connects between controller communication units.
2	Transmission connector	Connect a link cable to communicate with another controller.
3	Reception connector	
4	Terminator switch	If only one link cable is connected, turn this switch on. (Lower side: ON)
5	Connector for connecting the controller	Connect with the side panel of the controller.

## 3 MOUNTING

● In order to mount the BCD output unit (GP-XBCD) and the controller communication unit (GP-XCOM) to the controller, follow the procedures explained below.

① Peel off the side seal of the controller.

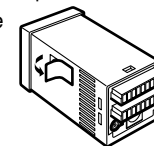

② Mount the controller and the mounting frame on the panel in the orientation shown in the figure below. For details, refer to the **GP-X** series user's manual.

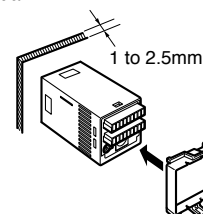

③ Mount GP-XBCD or GP-XCOM from the side.

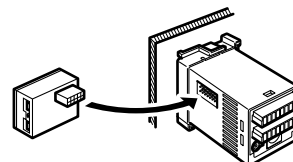

④ Mount the mounting bracket from the side.

(If the bracket interferes with another unit or the like and it cannot be mounted sideways,) mount from the rear while opening its arms.

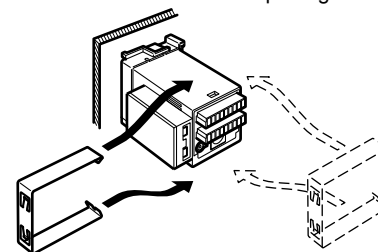

(Mounting from side)

(Mounting from rear)

⑤ Press portions A of the mounting bracket to snap portions B to fix the bracket, as shown in the figure below.

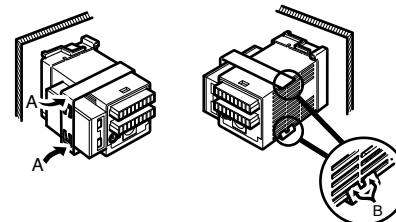

⑥ Connect the GP-XCOM as shown in the figure below. Turn the terminator switch on at the two units located at the both ends of the network. Turn the terminator switch off at the other units.

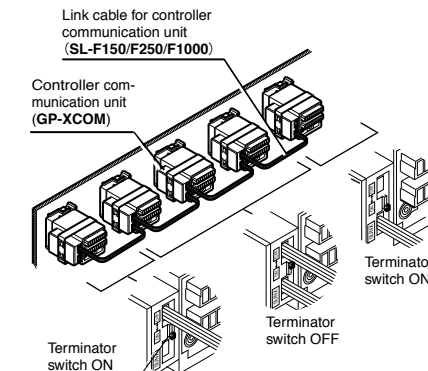

⑦ Turn the power ON.

⑧ Carry out the BCD output setting or the address setting. For details of the settings, refer to the **GP-X** series user's manual.

### ● Operating conditions for Compliance with CE Marking / UKCA Marking

- When using as a product in conformity with EMC Directive(2014/30/EU) / EMC Regulation(2016/1091), observe the following requirements and conditions.

#### Condition

- A ferrite clamp must be mounted within 10 mm of the base of the cable with connector on one end for BCD output unit (GP-XBCC3).
- In case of BCD output unit, wind the power cable connected to the controller GP-X once around the clamp filter for conformity to EMC directive.

When GP-XCOM is used, controllers cannot communicate if their software versions are not compatible. Use a correct combination, as shown below. For conforming method of the software version, or refer to the user's manual enclosed with the **GP-X** series.

- \* Ver. 1.06 or earlier version with Ver. 1.06 or earlier version: Possible
- Ver. 1.06 or earlier version with Ver. 1.10 or later version: Impossible
- Ver. 1.10 or later version with Ver. 1.10 or later version: Possible

**Panasonic Industry Co., Ltd.**

Panasonic Industrial Devices SUNX Co., Ltd.

<https://panasonic.net/id/pidsx/global>

Please visit our website for inquiries and about our sales network.

Panasonic Industrial Devices SUNX Co., Ltd. 2022

September, 2022

PRINTED IN JAPAN