

Programmable Controller

FP7 Analog Cassette User's Manual

Supported models

FP7 Extension Cassette (Function Cassette)

- Analog I/O Cassette (Product no. AFP7FCRA21)
- Analog Input Cassette (Product no. AFP7FCRAD2)
- Thermocouple Input Cassette (Product no. AFP7FCRTC2)

(MEMO)

Introduction

Thank you for buying a Panasonic product. Before you use the product, please carefully read the installation instructions and the users manual, and understand their contents in detail to use the product properly.

Types of Manual

- There are different types of user's manual for the FP7 series, as listed below. Please refer to a relevant manual for the unit and purpose of your use.
- The manuals can be downloaded from the Panasonic website:<https://industry.panasonic.com/global/en/downloads/?tab=manual>.

Unit name or purpose of use	Manual name	Manual code
FP7 Power Supply Unit	FP7 CPU Unit User's Manual (Hardware)	WUME-FP7CPUH
FP7 CPU Unit	FP7 CPU Unit Command Reference Manual	WUME-FP7CUPGR
	FP7 CPU Unit User's Manual (Logging Trace Function)	WUME-FP7CPULOG
	FP7 CPU Unit User's Manual (Security Function)	WUME-FP7CPUSEC
	Instructions for Built-in LAN Port	FP7 CPU Unit User's Manual (LAN Port Communication)
FP7 CPU Unit User's Manual (Ethernet Expansion Function)		WUME-FP7CPUETEX
FP7 CPU Unit User's Manual (EtherNet/IP Communication)		WUME-FP7CPUeIP
Web Server Function Manual		WUME-FP7WEB
Instructions for Built-in COM Port	FP7 Series User's Manual (SCU Communication)	WUME-FP7COM
FP7 Extension Cassette (Communication) (RS-232C / RS485 type)		
FP7 Extension Cassette (Communication) (Ethernet Type)	FP7 Series User's Manual (Communication Cassette Ethernet Type)	WUME-FP7CCET
FP7 Extension (Function) Cassette Analog Cassette	FP7 Analog Cassette User's Manual	WUME-FP7FCA
FP7 Digital Input / Output Unit	FP7 Digital Input / Output Unit User's Manual	WUME-FP7DIO
FP7 Analog Input Unit	FP7 Analog Input Unit User's Manual	WUME-FP7AIH
FP7 Analog Output Unit	FP7 Analog Output Unit User's Manual	WUME-FP7AOH
FP7 Thermocouple Multi-analog Input Unit	FP7 Thermocouple Multi-analog Input Unit FP7 RTD Input Unit	WUME-FP7TCRTD
FP7 RTD Input Unit	User's Manual	
FP7 Multi Input / Output Unit	FP7 Multi Input / Output Unit User's Manual	WUME-FP7MXY
FP7 High-speed counter unit	FP7 High-speed Counter Unit User's Manual	WUME-FP7HSC

Unit name or purpose of use	Manual name	Manual code
FP7 Pulse Output Unit	FP7 Pulse Output Unit User's Manual	WUME-FP7PG
FP7 Positioning Unit	FP7 Positioning Unit User's Manual	WUME-FP7POSP
FP7 Serial Communication Unit	FP7 Series User's Manual (SCU Communication)	WUME-FP7COM
FP7 Multi-wire Link Unit	FP7 Multi-wire Link Unit User's Manual	WUME-FP7MW
FP7 Motion Control Unit	FP7 Motion Control Unit User's Manual	WUME-FP7MCEC
PHLS System	PHLS System User's Manual	WUME-PHLS
Programming Software FPWIN GR7	FPWIN GR7 Introduction Guidance	WUME-FPWINGR7

Safety Precautions

- In order to prevent injuries and accidents, always adhere to the following.
- Always read this manual thoroughly before performing installation, operation, maintenance, and inspection, and use the device correctly.
- Ensure you are familiar with all device knowledge, safety information, and other precautions before use.
- In this manual, safety precaution levels are classified into "warnings" and "cautions".

WARNING

Cases where dangerous situations are expected to arise whereby the user could die or suffer serious injury if product is handled incorrectly

- Implement safety measures externally from this product so that the entire system can operate safely even if a failure occurs due to a fault in this product or some external factor.
- Do not use in an atmosphere containing flammable gases.
Doing so could cause explosions.
- Do not dispose of this product by placing it in fire.
This could cause splitting of batteries, electronic components, etc.

CAUTION

Cases where dangerous situations are expected to arise whereby the user could suffer injury or physical damage could occur if product is handled incorrectly



- In order to prevent the product from generating abnormal heat or emitting smoke, use the product with some margin to the guaranteed characteristics and performance values.
- Do not disassemble or modify the product.
Doing so could cause abnormal heat generation or smoke.
- Do not touch electrical terminals while the power is on.
There is a risk of electrical shock.
- Construct external emergency stop and interlock circuits.
- Securely connect wires and connectors.
Poor connections can cause abnormal heat generation or smoke.
- Do not allow foreign materials such as liquids, combustibles, or metals, to enter inside the product.
Doing so could cause abnormal heat generation or smoke.
- Do not perform work (connection, disconnection, etc.) while the power is on.
There is a risk of electrical shock.
- If methods other than those specified by our company are used when operating this product, the protection functions of the unit may be lost.
- This product was developed and manufactured for use in industrial environments.



Copyright / Trademarks

- The copyright of this manual is owned by **Panasonic Industry Co., Ltd.**
- Unauthorized reproduction of this manual is strictly prohibited.
- Windows is a registered trademark of Microsoft Corporation in the U.S. and other countries.
- Other company and product names are trademarks or registered trademarks of their respective companies.

Handling Precautions

- **In this manual, the following symbols are used to indicate safety information that must be observed.**

	Indicates an action that is prohibited or a matter that requires caution.
	Indicates an action that must be taken.
	Indicates supplemental information.

 Note	Indicates details about the subject in question or information useful to remember.
 Procedure	Indicates operation procedures.

FP7 Connector Compatibility

The connectors of old and new model FP7CPU units and add-on cassettes (hereinafter "cassettes") are shaped differently. Please use old model cassettes with old model units and new model cassettes with new model units as shown in the table below.

■ Old Model

Type	Old Product No.
CPU unit	AFP7CPS41ES, AFP7CPS41E, AFP7CPS31ES, AFP7CPS31E, AFP7CPS31S, AFP7CPS31, AFP7CPS21
Serial Communication Unit	AFP7NSC
Cassette	AFP7CCS1, AFP7CCS2, AFP7CCM1, AFP7CCM2, AFP7CCS1M1, AFP7CCET1, AFP7FCA21, AFP7FCAD2, AFP7FCTC2

■ New Model

Type	New Product No.
CPU unit	AFP7CPS4RES, AFP7CPS4RE, AFP7CPS3RES, AFP7CPS3RE, AFP7CPS3RS, AFP7CPS3R, AFP7CPS2R
Serial Communication Unit	AFP7NSCR
Cassette	AFP7CCRS1, AFP7CCRS2, AFP7CCRM1, AFP7CCRM2, AFP7CCRS1M1, AFP7CCRET1, AFP7FCRA21, AFP7FCRAD2, AFP7FCRTC2

Note

- Each FP7 unit can be connected to the CPU unit of a new or old model.
- Firmware version upgrades for the CPU unit are available for both new and old models.
- When attaching expansion cassettes to the FP7CPU unit, please use only old models, or only new models. Trying to attach a combination of old models and new models may cause damage.

Table of Contents

1 Unit Functions and Restrictions	1-1
1.1 Unit Functions and How They Work	1-2
1.1.1 Functions of Cassettes	1-2
1.1.2 Types and Model Numbers of Cassettes	1-2
1.2 Restrictions on Combinations of Units	1-3
1.2.1 Restrictions on Power Consumption	1-3
1.2.2 Applicable Versions of Unit and Software	1-3
1.2.3 Restrictions on the Combination of Extension Cassettes	1-3
2 Specifications	2-1
2.1 Analog I/O Cassette and Analog Input Cassette	2-2
2.1.1 Input Specifications (AFP7FCRA21 / AFP7FCRAD2)	2-2
2.1.2 Output Specifications (AFP7FCRA21).....	2-3
2.1.3 Switch Settings	2-3
2.1.4 Wiring.....	2-4
2.1.5 Input Conversion Characteristics (AFP7FCRA21 / AFP7FCRAD2)	2-6
2.1.6 Output Conversion Characteristics (AFP7FCRA21)	2-7
2.2 Thermocouple Input Cassette.....	2-9
2.2.1 Input Specifications (AFP7FCRTC2)	2-9
2.2.2 Switch Settings	2-9
2.2.3 Wiring.....	2-10
2.2.4 Input Conversion Characteristics	2-11
3 I/O Allocation and Programs	3-1
3.1 I/O Allocation.....	3-2
3.1.1 I/O Allocation.....	3-2
3.2 Sample Programs	3-3
3.2.1 Example of Analog Input/Output	3-3
3.2.2 Example of Thermocouple Input	3-3

(MEMO)

1 Unit Functions and Restrictions

1.1 Unit Functions and How They Work	1-2
1.1.1 Functions of Cassettes	1-2
1.1.2 Types and Model Numbers of Cassettes	1-2
1.2 Restrictions on Combinations of Units	1-3
1.2.1 Restrictions on Power Consumption	1-3
1.2.2 Applicable Versions of Unit and Software	1-3
1.2.3 Restrictions on the Combination of Extension Cassettes	1-3

1.1 Unit Functions and How They Work

1.1 Unit Functions and How They Work

1.1.1 Functions of Cassettes

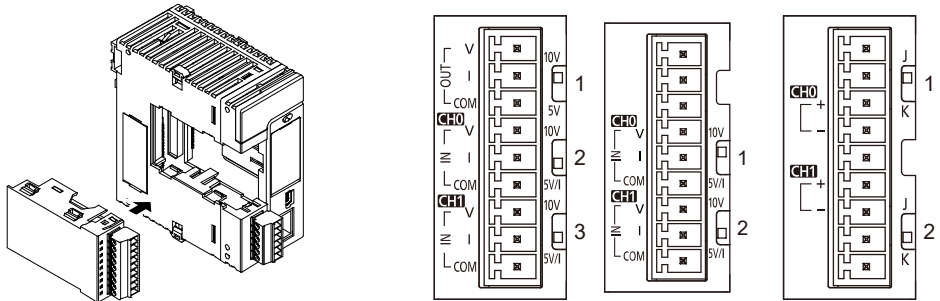

■ **Using these cassettes attached to the CPU unit enables analog I/O control.**

- An analog input and analog output can be controlled by attaching these extension cassettes to the CPU unit.
- It is selectable from three types of cassettes in accordance with the intended use.

■ **Input and output with simple programs**

- For input data, a digital conversion value (0 to 4000) is read as an input device (WX).
- For output data, a digital value (0 to 4000) is converted to analog output data by being written into an output device (WY).

■ **The input and output range is switchable.**

- The range can be switched with the switches on each cassette. The current input is switched according to wirings.

■ **Equipped with the thermocouple disconnection alarm function (Thermocouple input cassette)**

- When a thermocouple is disconnected, the value is digitally converted to the fixed value (K8000) so that you can determine the situation is not normal.

1.1.2 Types and Model Numbers of Cassettes

Name		Model No.
FP7 Extension Cassette (Function Cassette)	Analog I/O cassette	2-ch Input, 1-ch output
	Analog input cassette	2-ch input
	Thermocouple Input Cassette	2-ch input
		AFP7FCRA21
		AFP7FCRAD2
		AFP7FCRTC2

1.2 Restrictions on Combinations of Units

1.2.1 Restrictions on Power Consumption

The internal current consumption of the unit is as follows. Make sure that the total current consumption is within the capacity of the power supply with consideration of all other units used in combination with this unit.

Name	Specifications		Model No.	Current consumption
FP7 Extension Cassette (Function Cassette)	Analog I/O cassette	2-ch Input, 1-ch output	AFP7FCRA21	75 mA or less
	Analog input cassette	2-ch input	AFP7FCRAD2	40 mA or less
	Thermocouple Input Cassette	2-ch input	AFP7FCRTC2	45 mA or less

1.2.2 Applicable Versions of Unit and Software

For using the above function cassettes, the following versions of unit and software are required.

Items	Applicable version
FP7 CPU Unit	Ver.2.0 or later
Programming tool software FPWIN GR7	Ver.2.0 or later

1.2.3 Restrictions on the Combination of Extension Cassettes

There are following restrictions depending on units and cassettes to be used.

Unit type	Number of attachable cassettes	Attachable extension cassettes		
		Communication cassette AFP7CCRS* AFP7CCRM*	Communication cassette AFP7CCRET1	Function cassette AFP7FCR*
CPU Unit	Max. 1 unit	•	•	•
Serial Communication Unit	Max. 2 units Per unit	•	Not attachable	Not attachable

(MEMO)

2 Specifications

- 2.1 Analog I/O Cassette and Analog Input Cassette2-2
 - 2.1.1 Input Specifications (AFP7FCRA21 / AFP7FCRAD2) 2-2
 - 2.1.2 Output Specifications (AFP7FCRA21)..... 2-3
 - 2.1.3 Switch Settings 2-3
 - 2.1.4 Wiring 2-4
 - 2.1.5 Input Conversion Characteristics (AFP7FCRA21 / AFP7FCRAD2) 2-6
 - 2.1.6 Output Conversion Characteristics (AFP7FCRA21) 2-7
- 2.2 Thermocouple Input Cassette2-9
 - 2.2.1 Input Specifications (AFP7FCRTC2) 2-9
 - 2.2.2 Switch Settings 2-9
 - 2.2.3 Wiring 2-10
 - 2.2.4 Input Conversion Characteristics 2-11

2.1 Analog I/O Cassette and Analog Input Cassette

2.1 Analog I/O Cassette and Analog Input Cassette

2.1.1 Input Specifications (AFP7FCRA21 / AFP7FCRAD2)

■ Input specifications

Items		Description
No. of input points		2 channels (non-insulated between channels)
Input range	Voltage	0-10 V, 0-5 V (Can be set individually. Switchable)
	Current	0-20 mA
Digital conversion value		K0 to K4000 ^(Note 1)
Resolution		1/4000 (12-bit)
Conversion speed		1 ms/channel
Total accuracy		±1% F.S. or less (0 to 55°C)
Input impedance	Voltage	1 MΩ
	Current	250 Ω
Absolute max. input	Voltage	-0.5 V, +15 V (Voltage input)
	Current	+30 mA (Current input)
Insulation method		Between analog input terminal and internal digital circuit part: Transformer insulation, isolation IC insulation Between analog input terminal and analog output terminal: Transformer insulation, isolation IC insulation

(Note 1) When the analog input values exceed the upper and lower limits of the input range, the digital values maintain the upper and lower limit values.

(Note 2) Because of 12-bit resolution, the higher 4 bits of digital conversion value are always zero.

(Note 3) The time shown in the figure below is required to reflect analog input values in the input device area (WX) read by the CPU unit.

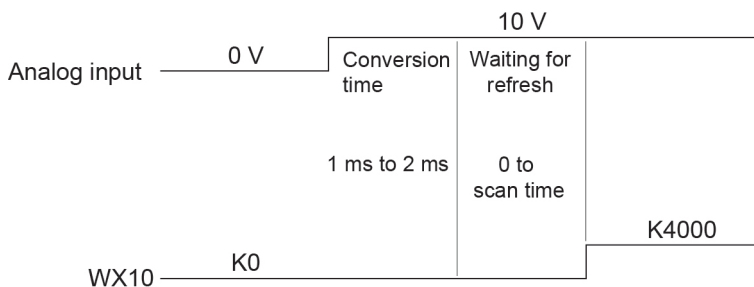

(Note 4) Averaging is not processed within the cassettes. Perform averaging with programs as necessary.

2.1.2 Output Specifications (AFP7FCRA21)

■ Output specifications

Items	Description
No. of output points	1 channel/cassette
Output range	Voltage 0 – 10 V, 0 – 5 V (Switchable)
	Current 0 – 20 mA
Digital value	K0 - K4000
Resolution	1/4000 (12-bit)
Conversion speed	1 ms/channel
Total accuracy	±1% F.S. or less (0 to 55°C)
Output impedance	0.5 Ω (Voltage output)
Output max. current	10 mA (Voltage output)
Output allowable load resistance	600 Ω or less (current output)
Insulation method	Between analog output terminal and internal digital circuit part: Transformer insulation, isolation IC insulation Between analog output terminal and analog input terminal: Transformer insulation, isolation IC insulation

■ Precautions on the characteristics of analog I/O cassette

- When the power to the CPU unit turns on or off, voltage (equivalent to 2 V) may be output for approx. 2 ms from the analog I/O cassette. If it will be a problem on your system, take necessary measures externally to avoid the transitional condition, e.g. turning on PLC before external devices or turning off external devices before PLC.

2.1.3 Switch Settings

- Set the range selection switches on the cassette before wiring.

■ Range selection switches (AFP7FCRA21)

	SW No.	Name	Voltage / Current I/O
	1	Output range selection switch ^(Note 1)	10 V 0 to +10 V
			5 V 0 to +5 V
	2	CH0 input range selection switch	10 V 0 to +10 V
			5 V/I 0 to +5 V / 0 to +20 mA
	3	CH1 input range selection switch	10 V 0 to +10 V
			5 V/I 0 to +5 V / 0 to +20 mA

2.1 Analog I/O Cassette and Analog Input Cassette

(Note 1) When using it as analog current output, it works in either case, regardless of the setting of the switches.

Range selection switches (AFP7FCRAD2)

	SW No.	Name	Voltage / Current input	
	1	CH0 input range selection switch	10 V	0 to +10 V
			5 V/I	0 to +5 V / 0 to +20 mA
	2	CH1 input range selection switch	10 V	0 to +10 V
			5 V/I	0 to +5 V / 0 to +20 mA

2.1.4 Wiring

Wiring Diagram

Voltage input

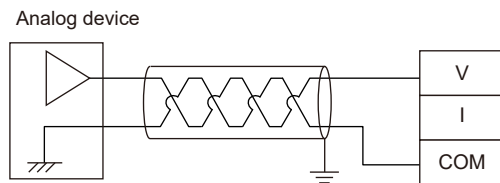

Current input

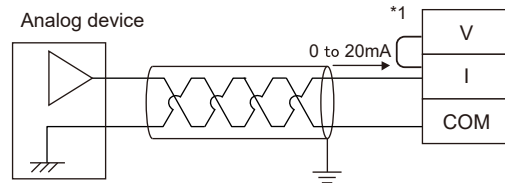

(Note 1) For the current input, short-circuit the V and I terminals.

Voltage output

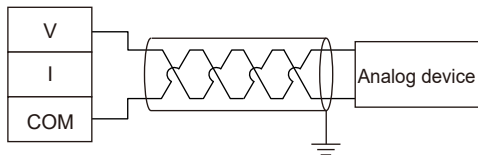

Current output

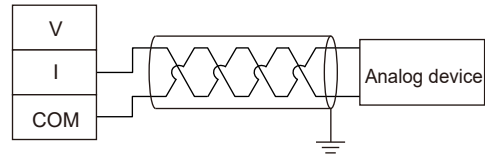

Precautions on wiring

- Use double-core twisted-pair shielded wires. It is recommended to ground them. However, depending on the conditions of the external noise, it may be better not to ground the shielding.
- Do not have the analog input wiring close to AC wires, power wires, or load. Also, do not bundle it with them.
- Do not have the analog output wiring close to AC wires, power wires, or load. Also, do not bundle it with them.

2.1 Analog I/O Cassette and Analog Input Cassette

- On the output circuit, a voltage amplifier and a current amplifier is connected in parallel to one D/A converter IC. Do not connect an analog device to the voltage output terminal and current output terminal of the same channel simultaneously.

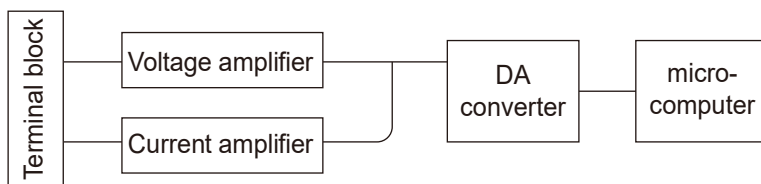

■ Terminal layout diagram (AFP7FCRA21)

Voltage input

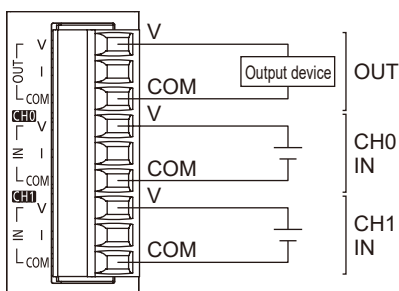

Current input

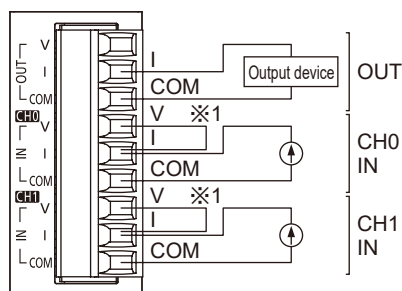

(Note 1) Connect the V and I terminals for using it as current input.

■ Terminal layout diagram (AFP7FCRAD2)

Voltage input

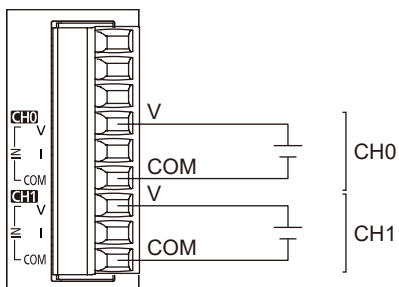

Current input

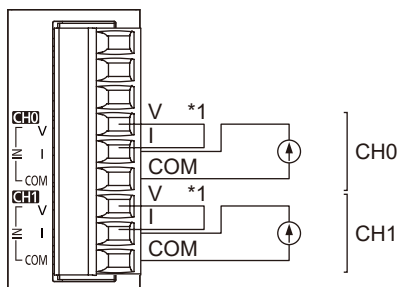

(Note 1) Connect the V and I terminals for using it as current input.

2.1 Analog I/O Cassette and Analog Input Cassette

2.1.5 Input Conversion Characteristics (AFP7FCRA21 / AFP7FCRAD2)

■ 0V to 10V DC input

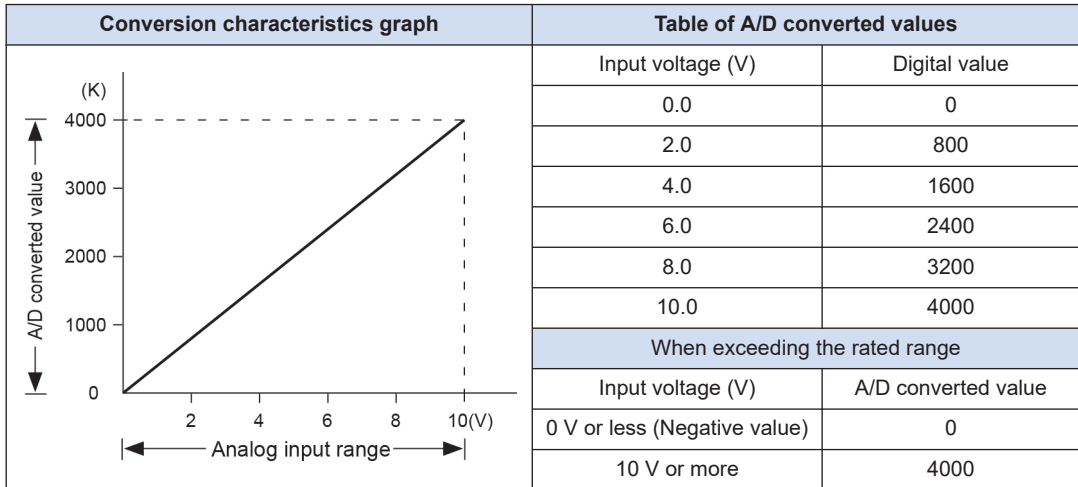

■ 0V to 5V DC input

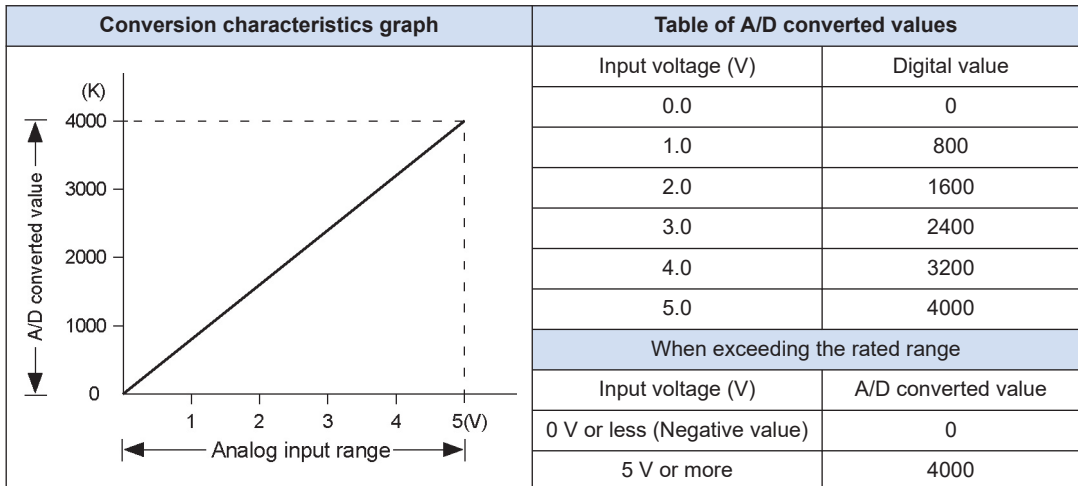

2.1 Analog I/O Cassette and Analog Input Cassette

■ 0mA to 20mA DC input

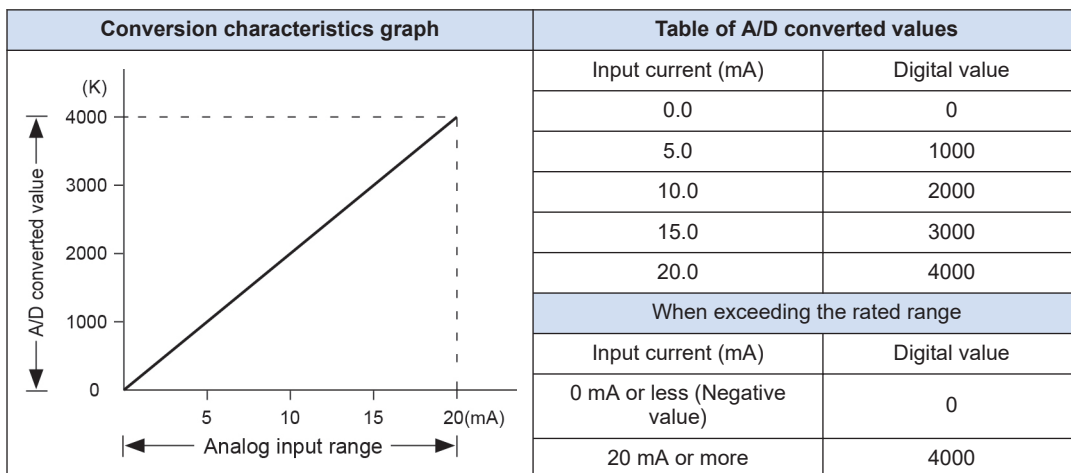

2.1.6 Output Conversion Characteristics (AFP7FCRA21)

■ 0V to 10V DC output

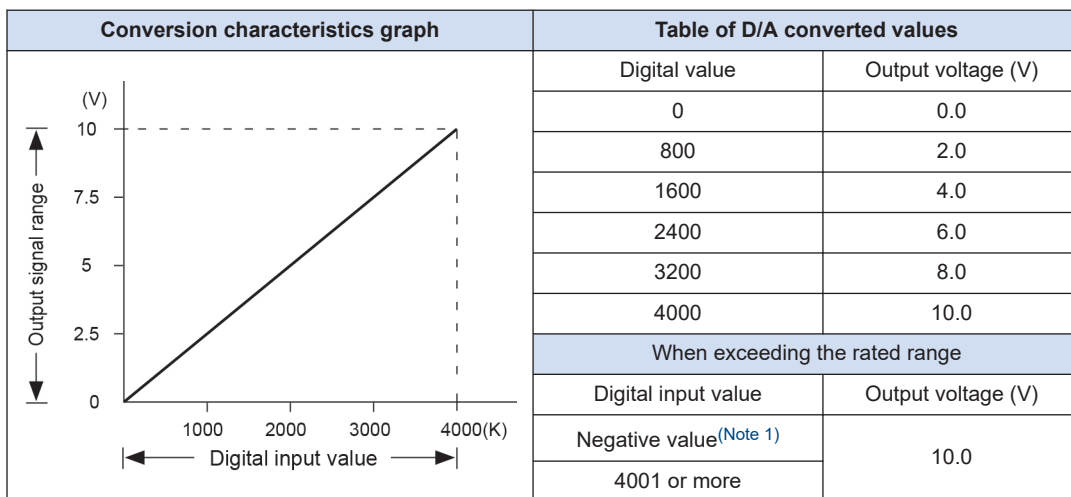

(Note 1) Digital input values are processed as unsigned 16-bit data (US).

2.1 Analog I/O Cassette and Analog Input Cassette

■ 0V to 5V DC output

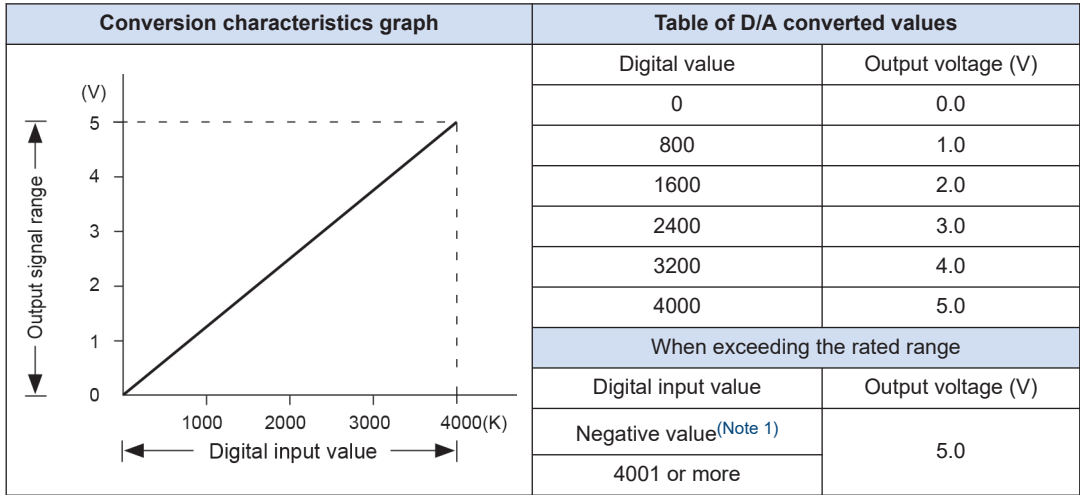

(Note 1) Digital input values are processed as unsigned 16-bit data (US).

■ 0mA to 20mA output

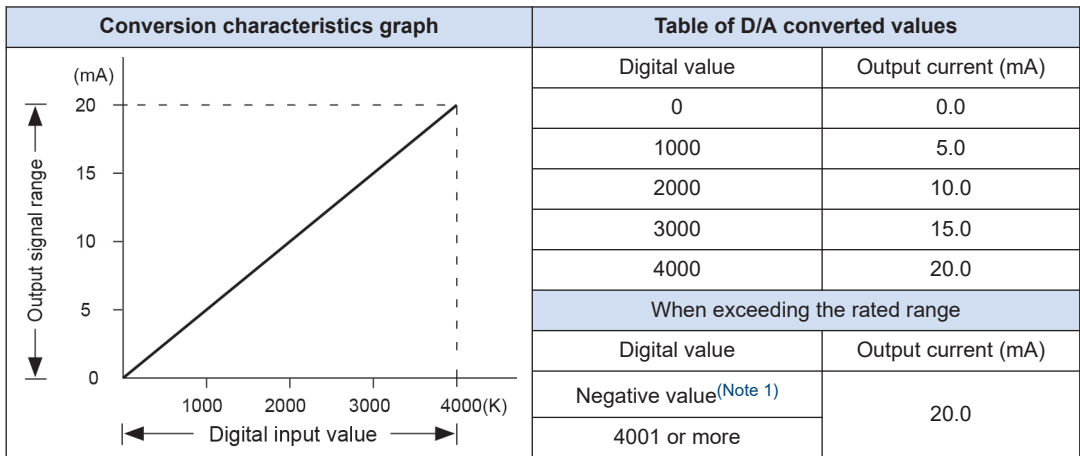

(Note 1) Digital input values are processed as unsigned 16-bit data (US).

2.2 Thermocouple Input Cassette

2.2.1 Input Specifications (AFP7FCRTC2)

■ Input specifications

Items	Description	
No. of input points	2 channels (insulated between channels)	
Input range	Thermocouple type K (-50.0 to 500.0°C), Thermocouple type J (-50.0 to 500.0°C)	
Digital value	In normal condition	K – 500 to K5000
	When exceeding rated range	K – 501, K5001 or K8000
	When wire is broken	K8000 ^(Note 1)
	When getting data ready	K8001 ^(Note 2)
Resolution	0.2°C (The indication is 0.1°C by the software averaging procedure.) ^(Note 3)	
Conversion speed	100 ms / 2 channels	
Total accuracy	0.5% F.S. + Cold junction error 1.5°C	
Input impedance	344 kΩ	
Insulation method	Transformer insulation, isolation IC insulation	

(Note 1) When the wire of thermocouple is broken or disconnected, the digital value will change to K8000 within 70 seconds. For replacing the thermocouple, program a process for avoiding a risk that would be resulted from the disconnecting.

(Note 2) From the Power-on to the converted data Ready, the digital conversion value will be K8001. Make a program not to use the data in the meantime as conversion values.

(Note 3) Although the resolution of the hardware is 0.2°C, it will be a conversion value by 0.1°C by the internal averaging procedure.

2.2.2 Switch Settings

- Set the range selection switches on the cassette before wiring.

2.2 Thermocouple Input Cassette

■ Thermocouple selection switches (AFP7FCRTC2)

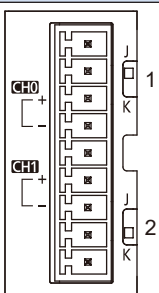
	SW No.	Name		Thermocouple
	1	CH0 thermocouple selection switch ^(Note 1)	J	Type J
			K	Type K
	2	CH1 thermocouple selection switch ^(Note 1)	J	Type J
			K	Type K

(Note 1) For the thermocouple selection switch, the setting at the time of power-on is effective for the operation. Note the setting will not be updated even if the switch is changed during the operation.

2.2.3 Wiring

■ Precautions on wiring

- Keep the space more than 100 mm between the input line and the power line/high-voltage line.

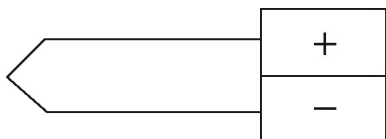

- It is recommended to ground the unit using the shielded compensating lead wire.

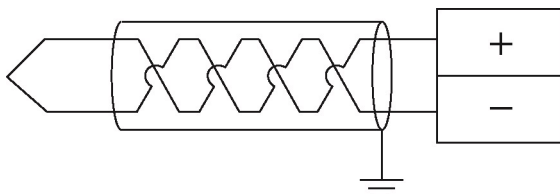

■ Terminal layout diagram (AFP7FCRTC2)

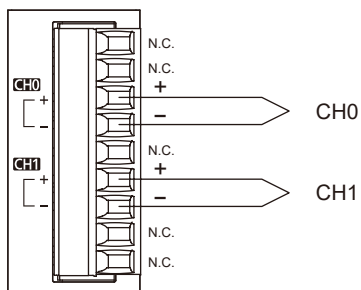

(Note 1) The N.C. terminals are used by the system. Do not connect anything.

2.2.4 Input Conversion Characteristics

■ Range of Thermocouples type K and J

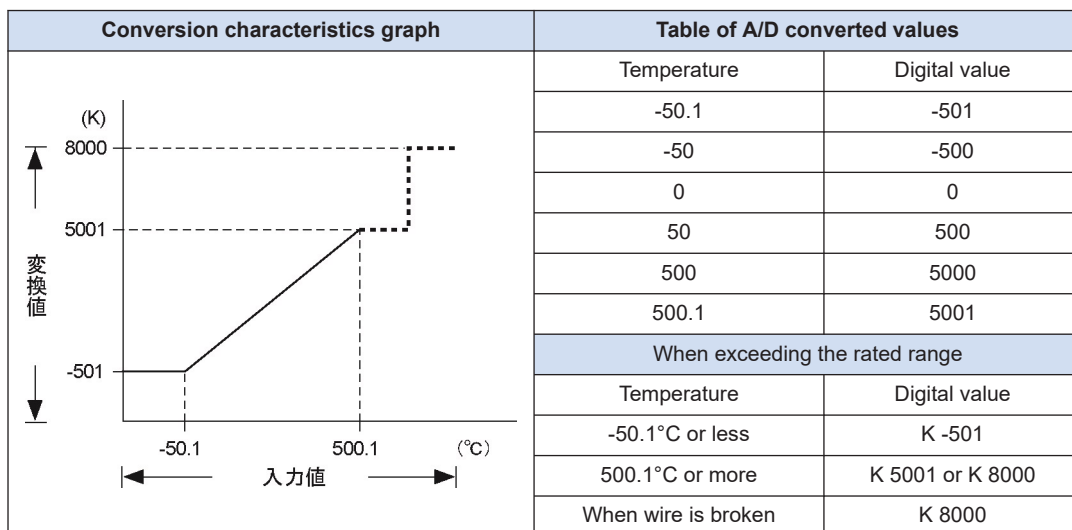

(MEMO)

3 I/O Allocation and Programs

3.1 I/O Allocation.....	3-2
3.1.1 I/O Allocation.....	3-2
3.2 Sample Programs	3-3
3.2.1 Example of Analog Input/Output	3-3
3.2.2 Example of Thermocouple Input	3-3

3.1 I/O Allocation

3.1 I/O Allocation

3.1.1 I/O Allocation

- The I/O areas of the CPU unit are allocated to each cassette.
- An area of one word (16 points) is allocated to a channel.

Description		Input		Output
		CH0	CH1	CH0
Analog I/O cassette	2-ch Input, 1-ch output	WX2	WX3	WY2
Analog input cassette	2-ch input	WX2	WX3	-
Thermocouple Input Cassette	2-ch input	WX2	WX3	-

(Note 1) The starting numbers of I/O contacts of each unit including the CPU unit can be changed by the setting of tool software.

3.2 Sample Programs

3.2.1 Example of Analog Input/Output

- For analog input, digital conversion values are read from the device area (WX) of the input relay.
- For analog output, digital conversion values are written into the device area (WY) of the output relay.

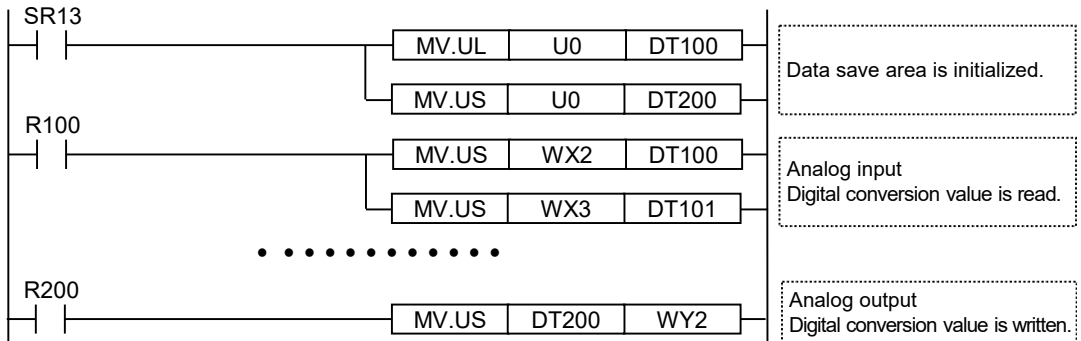

3.2.2 Example of Thermocouple Input

- For thermocouple input, digital conversion values are read from the device area (WX) of the input relay.
- Make a program not to use the values as normal converted data until the completion of data preparation at the time of power-on, or when disconnecting is detected.

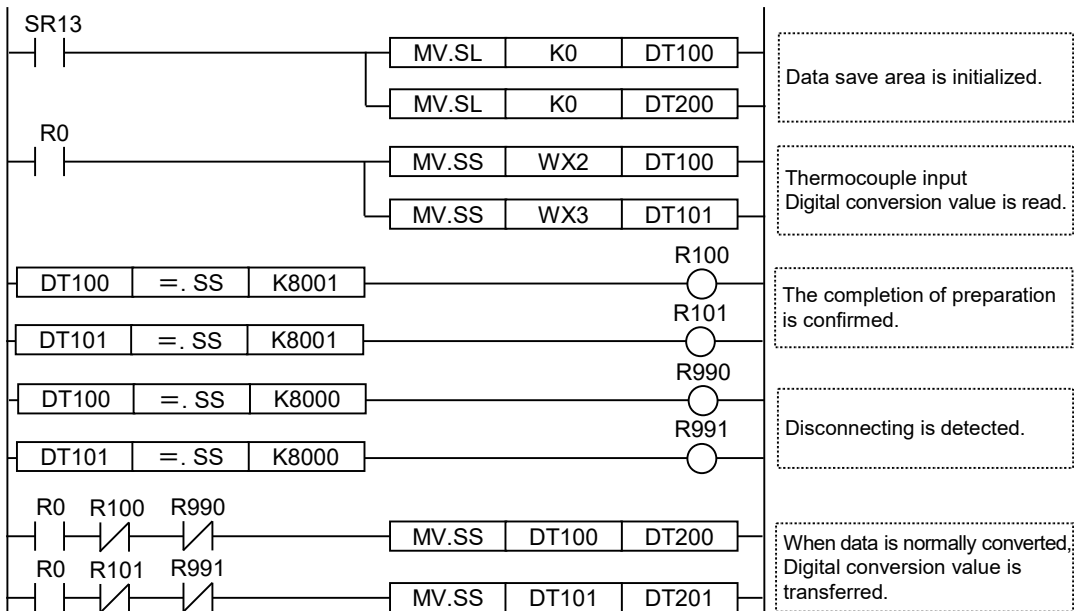

(MEMO)

Record of Changes

The manual number can be found at the bottom of the manual cover.

Date	Manual No.	Record of Changes
Dec. 2013	WUME-FP7FCA-01	1st Edition
Nov. 2022	WUME-FP7FCA-02	2nd Edition <ul style="list-style-type: none">• Changed product type following FP7 update• Changed manual formatting
Apr. 2024	WUME-FP7FCA-03	3rd Edition <ul style="list-style-type: none">• Change in Corporate name

Order Placement Recommendations and Considerations

The Products and Specifications listed in this document are subject to change (including specifications, manufacturing facility and discontinuing the Products) as occasioned by the improvements of Products. Consequently, when you place orders for these Products, Panasonic Industry Co., Ltd. asks you to contact one of our customer service representatives and check that the details listed in the document are commensurate with the most up-to-date information.

[Safety precautions]

Panasonic Industry Co., Ltd. is consistently striving to improve quality and reliability. However, the fact remains that electrical components and devices generally cause failures at a given statistical probability. Furthermore, their durability varies with use environments or use conditions. In this respect, check for actual electrical components and devices under actual conditions before use. Continued usage in a state of degraded condition may cause the deteriorated insulation. Thus, it may result in abnormal heat, smoke or fire. Carry out safety design and periodic maintenance including redundancy design, design for fire spread prevention, and design for malfunction prevention so that no accidents resulting in injury or death, fire accidents, or social damage will be caused as a result of failure of the Products or ending life of the Products.

The Products are designed and manufactured for the industrial indoor environment use. Make sure standards, laws and regulations in case the Products are incorporated to machinery, system, apparatus, and so forth. With regard to the mentioned above, confirm the conformity of the Products by yourself.

Do not use the Products for the application which breakdown or malfunction of Products may cause damage to the body or property.

- i) usage intended to protect the body and ensure security of life
- ii) application which the performance degradation or quality problems, such as breakdown, of the Products may directly result in damage to the body or property

It is not allowed the use of Products by incorporating into machinery and systems indicated below because the conformity, performance, and quality of Products are not guaranteed under such usage.

- i) transport machinery (cars, trains, boats and ships, etc.)
- ii) control equipment for transportation
- iii) disaster-prevention equipment / security equipment
- iv) control equipment for electric power generation
- v) nuclear control system
- vi) aircraft equipment, aerospace equipment, and submarine repeater
- vii) burning appliances
- viii) military devices
- ix) medical devices (except for general controls)
- x) machinery and systems which especially require the high level of reliability and safety

[Acceptance inspection]

In connection with the Products you have purchased from us or with the Products delivered to your premises, please perform an acceptance inspection with all due speed and, in connection with the handling of our Products both before and during the acceptance inspection, please give full consideration to the control and preservation of our Products.

[Warranty period]

Unless otherwise stipulated by both parties, the warranty period of our Products is three years after the purchase by you or after their delivery to the location specified by you. The consumable items such as battery, relay, filter and other supplemental materials are excluded from the warranty.

[Scope of warranty]

In the event that Panasonic Industry Co., Ltd. confirms any failures or defects of the Products by reasons solely attributable to Panasonic Industry Co., Ltd. during the warranty period, Panasonic Industry Co., Ltd. shall supply the replacements of the Products, parts or replace and/or repair the defective portion by free of charge at the location where the Products were purchased or delivered to your premises as soon as possible.

However, the following failures and defects are not covered by warranty and we are not responsible for such failures and defects.

- (1) When the failure or defect was caused by a specification, standard, handling method, etc. which was specified by you.
- (2) When the failure or defect was caused after purchase or delivery to your premises by an alteration in construction, performance, specification, etc. which did not involve us.
- (3) When the failure or defect was caused by a phenomenon that could not be predicted by the technology at purchasing or contracted time.
- (4) When the use of our Products deviated from the scope of the conditions and environment set forth in the instruction manual and specifications.
- (5) When, after our Products were incorporated into your products or equipment for use, damage resulted which could have been avoided if your products or equipment had been equipped with the functions, construction, etc. the provision of which is accepted practice in the industry.
- (6) When the failure or defect was caused by a natural disaster or other force majeure.
- (7) When the equipment is damaged due to corrosion caused by corrosive gases etc. in the surroundings.

The above terms and conditions shall not cover any induced damages by the failure or defects of the Products, and not cover your production items which are produced or fabricated by using the Products. In any case, our responsibility for compensation is limited to the amount paid for the Products.

[Scope of service]

The cost of delivered Products does not include the cost of dispatching an engineer, etc. In case any such service is needed, contact our sales representative.

Panasonic Industry Co., Ltd.

(MEMO)

Panasonic Industry Co., Ltd.

1006, Oaza Kadoma, Kadoma-shi, Osaka 571-8506, Japan
<https://industry.panasonic.com/>

Please visit our website for inquiries and about our sales network.

© Panasonic Industry Co., Ltd. 2013-2024

April, 2024

WUME-FP7FCA-03