

Programmable Controller

# FP0H Control Unit User's Manual

---

COM Communication

(MEMO)

## Introduction

Thank you for purchasing a Panasonic product. Before you use the product, please carefully read through the user's manual, and understand it in detail to use the product properly.

## Types of Manual

- This manual describes communication functions via “RS-232C / RS-485” port installed in FP0H Control Unit and communication cassette.
- There are different types of users manuals related to the FP0H series. Please refer to a relevant manual for the unit and purpose of your use.
- The manuals can be downloaded on our website: <https://industry.panasonic.com/global/en/downloads/?tab=manual>.

Unit name or purpose of use	Manual name	Manual code
FP0H Control Unit	FP0H User's Manual (Basic)	WUME-FP0HBAS
	FP0H Programming Manual	WUME-FP0HPGR
	FP0H Programming Manual (SD Card Access Instructions)	WUME-FP0HSD
Positioning Function/PWM Output/High-speed Counter Function	FP0H User's Manual (Positioning/PWM Output/High-speed Counter)	WUME-FP0HPOS
Serial Communication Function	FP0H User's Manual (COM Communication)	WUME-FP0HCOM
Ethernet Communication Function	FP0H User's Manual (Ethernet Communication)	WUME-FP0HET
EtherNet/IP Communication Function	FP0H User's Manual (EtherNet/IP)	WUME-FP0HEIP
Logging trace function	FP0H User's Manual (Logging/Trace Function)	WUME-FP0HLOG
FP0H Extension (Communication) Cassette	FP0H User's Manual (COM Communication)	WUME-FP0HCOM
FP0H Positioning Unit	FP0H Positioning Unit User's Manual	WUME-FP0HPG
FP0H Positioning Unit RTEX	FP0H Positioning Unit RTEX User's Manual (FPWIN GR7)	WUME-FP0HRTEXGR7

## SAFETY PRECAUTIONS

- To prevent accidents or personal injuries, please be sure to comply with the following items.
- Prior to installation, operation, maintenance and check, please read this manual carefully for proper use.
- Before using, please fully understand the knowledge related to the equipment, safety precautions and all other precautions.
- Safety precautions are divided into two levels in this manual: Warning and Caution.

 **WARNING** Incorrect operation may lead to death or serious injury.

- Take appropriate safety measures to the external circuit of the product to ensure the security of the whole system in case of abnormalities caused by product failure or external.
- Do not use this product in areas with inflammable gases.  
Otherwise it may lead to an explosion.
- Do not put this product into a fire.  
Otherwise it could cause damage to the battery or other electronic parts.

 **CAUTION** Incorrect operation may lead to injury or material loss.

- To prevent the excessive exothermic heat or smoke generation of the product, a certain margin is required for guaranteed characteristics and performance ratings of relative products.
- Do not decompose or transform it.  
Otherwise it will lead to the excessive exothermic heat or smoke generation of the product.
- Do not touch terminal blocks during power-on.  
Otherwise it may result in an electric shock.
- Set an emergency stop and interlock circuit in the external devices.
- Connect wires and connectors reliably.  
Otherwise it may lead to the excessive exothermic heat or smoke generation of the product.
- Do not undertake construction (such as connection and disconnection) while the power supply is on.  
It could lead to an electric shock.
- If the equipment is used in a manner not specified by the Panasonic, the protection provided by the equipment may be impaired.
- This product has been developed/produced for industrial use only.

## Description on Copyright and Trademarks

- The copyright of this manual is owned by **Panasonic Industry Co., Ltd.**
- Unauthorized reproduction of this manual is strictly prohibited.
- Windows is a registered trademark of Microsoft Corporation in the U.S. and other countries.
- Ethernet is a registered trademark of FUJIFILM Business Innovation Corp. and Xerox Corporation.
- EtherNet/IP is a registered trademark of ODVA (Open DeviceNet Vendor Association).
- SDHC and SD logos are trademarks of LLC.
- Other company and product names are trademarks or registered trademarks of their respective companies.

# Table of Contents

<b>1 Unit Functions and Restrictions on Combination .....</b>	<b>1-1</b>
1.1 Unit Functions and Features .....	1-2
1.1.1 Unit Functions .....	1-2
1.1.2 Names and Functions of Parts .....	1-2
1.1.3 Restrictions on Communication Functions to be Used .....	1-3
1.2 Overview of Communication Functions .....	1-4
1.2.1 PLC Link Function (MEWNET-W0) .....	1-4
1.2.2 MEWTOCOL Master / Slave Communication .....	1-4
1.2.3 MODBUS RTU Master / Slave Communication .....	1-6
1.2.4 General-Purpose Communication .....	1-7
<b>2 Wiring of COM Port .....</b>	<b>2-1</b>
2.1 Installation of Extension (Communication) Cassette .....	2-2
2.1.1 Precautions When Installing Extension (Communication) Cassette .....	2-2
2.1.2 Installing Extension (Communication) Cassette .....	2-2
2.2 Wiring of the COM Port Terminal Block .....	2-3
2.2.1 Suitable Wires and Tools .....	2-3
2.2.2 Applicable Cable .....	2-4
2.2.3 Wiring Method .....	2-4
2.3 Wiring of the Control Unit (GT Power Supply, COM0 Port) .....	2-6
2.3.1 Handling of GT Power Supply Terminal .....	2-6
2.3.2 Terminal Layout Diagrams and Wiring Examples .....	2-6
2.4 Wiring of COM Port of a Communication Cassette .....	2-8
2.4.1 AFP0HCCS1 (RS-232C 1ch Non-Insulated Type) .....	2-8
2.4.2 AFP0HCCS2 (RS-232C 2ch Non-Insulated Type) .....	2-9
2.4.3 AFP0HCCM1 (RS-485 1ch Insulated Type) .....	2-9
2.4.4 AFP0HCCS1M1 (RS-485 1ch insulated + RS-232C 1ch Non-Insulated Type) .....	2-10
<b>3 Setting and Confirmation of Communication Conditions .....</b>	<b>3-1</b>
3.1 Setting of Purpose and Communication Conditions .....	3-2
3.1.1 Purpose to be Set for Each Port .....	3-2
3.1.2 Communication Conditions to be Set for Each Port .....	3-2
3.2 Communication Conditions Settings .....	3-4
3.2.1 System Register Settings .....	3-4
3.2.2 Settings Using a Program .....	3-4
<b>4 PLC link .....</b>	<b>4-1</b>
4.1 Operation of PLC Link MEWNET-W0 .....	4-2
4.1.1 Operation Overview of PLC Link .....	4-2
4.1.2 Roles of Link Relays and Link Registers .....	4-2
4.2 Setting Items for PLC Link .....	4-4
4.2.1 Unit Number Setting .....	4-4
4.2.2 Setting of the Largest Unit Number .....	4-4
4.2.3 Memory Block No. of Link Relays and Link Registers to be Used .....	4-4

4.2.4	Ranges of Link Relays and Link Registers to be Used .....	4-5
4.2.5	Link Relay Transmission Start Number and Sending Size .....	4-5
4.2.6	Link Register Transmission Start Number and Sending Size .....	4-6
4.3	Response Time of PLC Link .....	4-9
4.3.1	Response Time of One Transmission Cycle .....	4-9
4.3.2	Response Time when There are Units that have not been Added to the Link .....	4-10
<b>5</b>	<b>MEWTOCOL Master-Slave Communication .....</b>	<b>5-1</b>
5.1	List of MEWTOCOL Supported Commands .....	5-2
5.1.1	List of MEWTOCOL-COM Commands .....	5-2
5.2	MEWTOCOL-COM Master Communication (RECV).....	5-3
5.2.1	For Type without Ethernet Function .....	5-3
5.2.2	For Type with Ethernet Function .....	5-5
5.3	MEWTOCOL-COM Master Communication (SEND).....	5-8
5.3.1	For Type without Ethernet Function .....	5-8
5.3.2	For Type with Ethernet Function .....	5-10
<b>6</b>	<b>MODBUS RTU Master-Slave Communication .....</b>	<b>6-1</b>
6.1	List of MODBUS RTU Supported Commands .....	6-2
6.1.1	List of MODBUS Function Codes .....	6-2
6.1.2	Device No. Correspondence Table .....	6-2
6.2	MODBUS RTU Master Communication (RECV) .....	6-3
6.2.1	For Type without Ethernet Function .....	6-3
6.2.2	For Type with Ethernet Function .....	6-5
6.3	MODBUS RTU Master Communication (SEND) .....	6-8
6.3.1	For Type without Ethernet Function .....	6-8
6.3.2	For Type with Ethernet Function .....	6-10
<b>7</b>	<b>General-Purpose Communication .....</b>	<b>7-1</b>
7.1	Overview of Sending Data .....	7-2
7.1.1	Overview of Sending Data (For Type without Ethernet Function) .....	7-2
7.1.2	Overview of Sending Data (For Type with Ethernet Function) ....	7-3
7.1.3	Send Data Area .....	7-5
7.2	Receiving Data from External Devices .....	7-6
7.2.1	Receiving Data from External Devices (For Type without Ethernet Function) .....	7-6
7.2.2	Receiving Data from External Devices (For Type with Ethernet Function) .....	7-7
7.2.3	Receive data area .....	7-9
7.3	Flag Operations in Transmission / Reception .....	7-10
7.3.1	When the Header is Set to “No STX” and the Terminator to “CR” ...	7-10
7.3.2	When the Header is Set to “STX” and the Terminator to “ETX” .....	7-11
<b>8</b>	<b>Instruction References .....</b>	<b>8-1</b>
8.1	Serial Communication Instructions .....	8-2
8.1.1	F145 SEND / F146 RECV Instructions: Common Items (Serial Communication).....	8-2
8.1.2	F145 SEND [MEWTOCOL Master Send (Serial Communication)]..	8-3

8.1.3 F146 REC [MEWTOCOL Master Receiver (Serial Communication)].....	8-6
8.1.4 F145 SEND [MODBUS Master Send: Function Code Specification (Serial Communication)] .....	8-9
8.1.5 F146 RECV [MODBUS Master Receiver: Function Code Specification (Serial Communication)].....	8-15
8.1.6 F145 SEND [MODBUS Master Send: No Function Code Specification (Serial Communication)].....	8-19
8.1.7 F146 RECV [MODBUS Master Receiver: No Function Code Specification (Serial Communication)].....	8-25
8.1.8 F159 MTRN [General-purpose Communication Instructions (Serial Communication)].....	8-32
8.2 Character String Instructions .....	8-37
8.2.1 F253 SSET (Character Constant → ASCII Code Conversion: with Storage Area Size).....	8-37
8.3 Ethernet Instruction (Only For Type with Ethernet Function).....	8-41
8.3.1 [F469 UNITSEL] (Communication Unit Slot Port Specification).....	8-41
8.4 Special Instruction.....	8-43
8.4.1 SYS1 (Communication Condition Setting).....	8-43
<b>9 Troubleshooting .....</b>	<b>9-1</b>
9.1 What to Do If an Error Occurs.....	9-2
9.1.1 Communication Error Occurs (RS-232C) .....	9-2
9.1.2 Communication Error Occurs (RS-485).....	9-2
<b>10 Description .....</b>	<b>10-1</b>
10.1 Communication Function Specifications.....	10-2
10.1.1 Communication Specifications of the Control Unit.....	10-2
10.1.2 Communication Cassette Specifications.....	10-2
10.2 List of System Registers .....	10-4
10.3 List of Special Relays (COM Communication).....	10-12
10.4 List of Special Data Registers (COM Communication).....	10-21
10.5 Error Codes Table .....	10-26
10.5.1 List of MEWTOCOL-COM/DAT Communication Error Codes .....	10-26
10.5.2 List of MODBUS Communication Error Codes .....	10-27
10.6 MEWTOCOL-COM Format.....	10-28
10.6.1 MEWTOCOL-COM Command Type.....	10-28
10.6.2 MEWTOCOL-COM Response Format.....	10-29
10.7 MODBUS RTU Format .....	10-31
10.7.1 MODBUS RTU Command Format.....	10-31
10.7.2 MODBUS RTU Response Format .....	10-31

(MEMO)



# 1 Unit Functions and Restrictions on Combination

---

1.1 Unit Functions and Features.....	1-2
1.1.1 Unit Functions .....	1-2
1.1.2 Names and Functions of Parts.....	1-2
1.1.3 Restrictions on Communication Functions to be Used .....	1-3
1.2 Overview of Communication Functions .....	1-4
1.2.1 PLC Link Function (MEWNET-W0).....	1-4
1.2.2 MEWTOCOL Master / Slave Communication .....	1-4
1.2.3 MODBUS RTU Master / Slave Communication .....	1-6
1.2.4 General-Purpose Communication.....	1-7

# 1.1 Unit Functions and Features

## 1.1 Unit Functions and Features

### 1.1.1 Unit Functions

■ **Removable serial communication cassettes are used**

- Can be selected from four communication cassettes (sold separately) that conform to communication standards RS-232C and RS-485.
- One communication cassette can be attached to the control unit.

■ **The control unit has a built-in COM0 port as standard equipment**

The control unit has a built-in RS-232C port (3-wire type) for connection with a programmable display, and a 5V power supply, as standard equipment.

■ **Four communication modes are available**

Different communication modes are available (PLC link, MEWTOCOL, MODBUS-RTU, and general-purpose communication mode). Depending on combination with communication cassettes, the product can be connected with diverse serial communication devices.

### 1.1.2 Names and Functions of Parts

The names and functions of parts pertaining to communication functions are indicated below.

AFP0HC32T

AFP0HC32ET

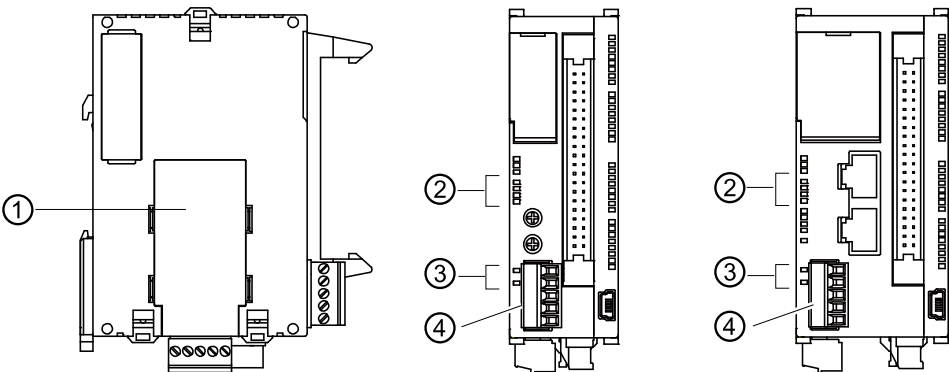

No.	Name	Description
(1)	Communication cassette (optional)	Can be selected and attached from four types of cassettes.
(2)	Operation monitor LED (for COM1 / COM2)	Flashes during transmission / reception by a cassette
(3)	Operation monitor LED (for COM0)	Flashes during transmission / reception by COM0 port
(4)	COM0 port	Three-wire RS-232C port. A power supply terminal (5 V) is also provided for connecting our Programmable Display GT02/GT02L series.

### 1.1.3 Restrictions on Communication Functions to be Used

- When a communication port that is built in the control unit as standard equipment or a communication cassette is used, the following restrictions are applied depending on functions to be used.
- Allocated communication port No. varies by the type of cassette.

■ **Types of communication ports / cassettes (●: Available; ○: Conditional; Blank : Not available)**

Product No.	Communication interface	Main unit		Cassette	
		USB	COM0	COM1	COM2
Control unit (standard equipment)	USB x 1 channel	●			
	RS-232C (3-wire type) ×1 channel		●		
AFP0HCCS1	RS-232C (5-wire type) ×1 channels			●	
AFP0HCCS2	RS-232C (3-wire type) ×2 channels			●	●
AFP0HCCM1	RS-485 x 1 channel			●	
AFP0HCCS1M1	RS-485 x 1 channel			●	
	RS-232C (3-wire type) ×1 channels				●

(Note 1) The RS-232C port of AFP0HCCS1 is a 5-wire type capable of RS / CS control.

(Note 2) With AFP0HCCS1M1, both RS-485 x 1 channel and RS-232C (3-wire type) ×1 channel can be used.

■ **List of available functions by communication port (●: Available; ○: Conditional; Blank : Not available)**

Available communication functions		Main unit		Cassette	
		USB	COM0	COM1	COM2
PLC link			○ (Note 1)	○ (Note 1)	
MEWTOCOL-COM	Master		●	●	●
	Slave	●	●	●	●
MODBUS-RTU	Master		●	●	●
	Slave		●	●	●
General-purpose communication			●	●	●

(Note 1) For PLC link, only one port may be used (either COM0 port that is built in the control unit as standard equipment, or COM1 port on a cassette).

## 1.2 Overview of Communication Functions

### 1.2 Overview of Communication Functions

#### 1.2.1 PLC Link Function (MEWNET-W0)

##### ■ Overview of function

- A system can be configured for the PLC link (MEWNET-W0).
- Exclusive internal relays “link relays (L)” and data registers “link registers (LD)” are shared between connected PLCs.
- Data of link relays (1024 points) and link registers (128 words) can be exchanged between max. 16 PLC units.

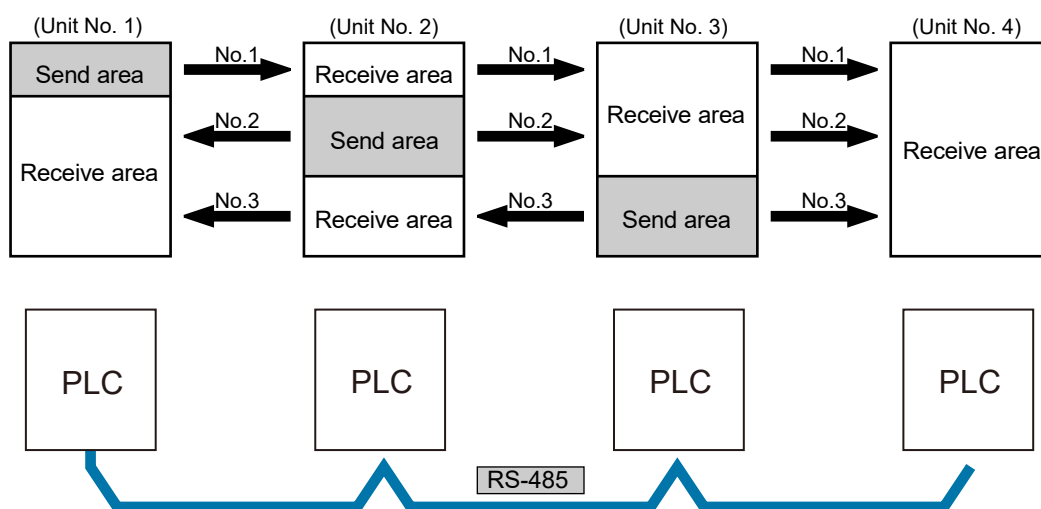

##### ■ Purpose of PLC link function (MEWNET-W0)

This is used when using the following models and link functions of Panasonic FP series PLCs. 1:1 communication is also possible via RS-232C port.

- FP-X0 (L40MR / L60MR)
- FP0R (RS-485 type)
- FP0H (communication cassette RS-485 type is used)
- FPsigma (communication cassette RS-485 type is used)
- FP-X (communication cassette RS-485 type is used)
- FP2 multi-communication unit (communication cassette RS-485 type is used)
- FP7CPU unit (communication cassette RS-485 type is used)

#### 1.2.2 MEWTOCOL Master / Slave Communication

##### ■ Overview of function

- Communication is performed using a communication protocol “MEWTOCOL-COM” used by Panasonic PLC.

- Master communication is performed by PLC sending commands to, and receiving responses from, devices that support MEWTOCOL. Data can be read and written by specifying unit numbers and memory addresses and executing F145 (SEND) / F146 (RECV) instructions in a user program, because PLC automatically creates messages according to the protocol.
- A computer or display connected to PLC has the transmission right in slave communication. Slave communication is performed when the device sends a command, and PLC returns a response. In slave communication, no communication program is required on the PLC side, because PLC automatically returns a response.
- The data size that can be sent or received at a time is a maximum of 507 words for register transmission, 509 words for register reception, and 1 bit for bit transmission or reception.

### Master function

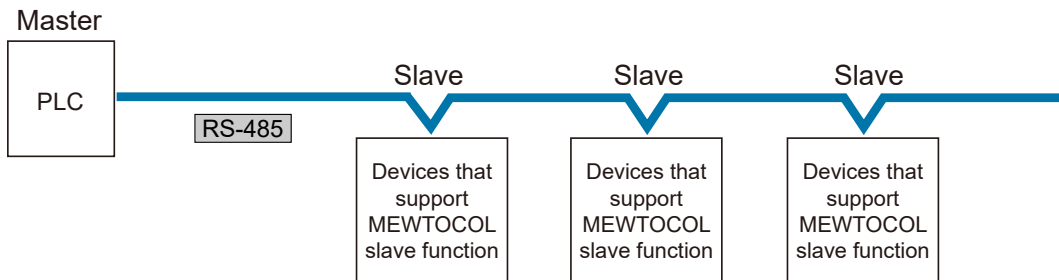

### Slave function

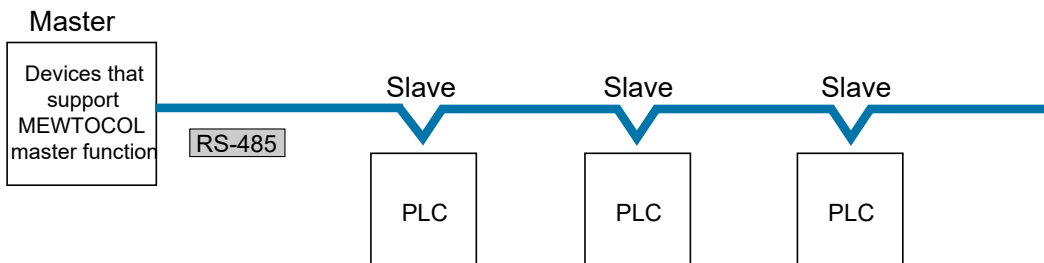

#### ■ Purpose of MEWTOCOL master communication (example)

This is used for connection with devices that support MEWTOCOL (Panasonic PLC protocol).

- Programmable controller FP series
- Displacement sensor HL series
- Eco-power meter KW series

#### ■ Purpose of MEWTOCOL slave communication (example)

This is used for connection with devices that support MEWTOCOL-COM master communication (Panasonic PLC protocol).

- Programmable displays from other manufacturers

## 1.2 Overview of Communication Functions

### 1.2.3 MODBUS RTU Master / Slave Communication

#### ■ Overview of function

- Used for communication with other devices that support the MODBUS RTU protocol.
- Master communication is performed when the master unit sends commands to slave units, and the slave unit returns responses (response messages) according to the instructions. Data can be read and written between PLC and external devices by specifying unit numbers and memory addresses and executing F145 (SEND) / F146 (RECV) instructions in a user program, because PLC automatically creates messages according to the protocol.
- A higher device connected to PLC has the transmission right in slave communication. Slave communication is performed when the device sends a command, and PLC returns a response. In slave communication, no communication program is required on the PLC side, because PLC automatically returns a response.
- The data size that can be sent or received at a time is a maximum of 127 words for register transmission, and 2,040 bits for bit transmission.

#### Master function

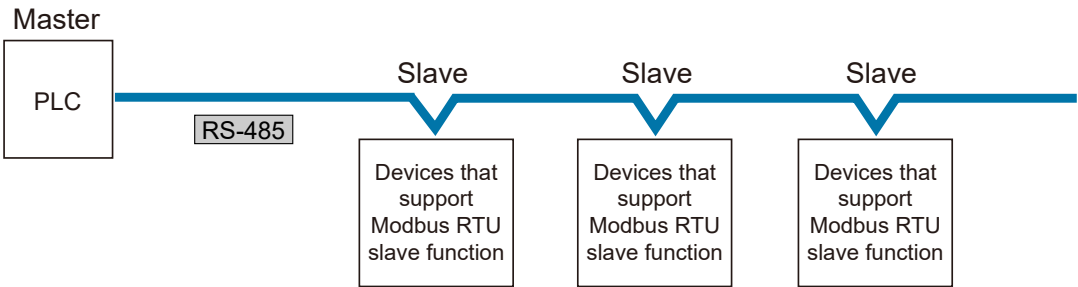

#### Slave function

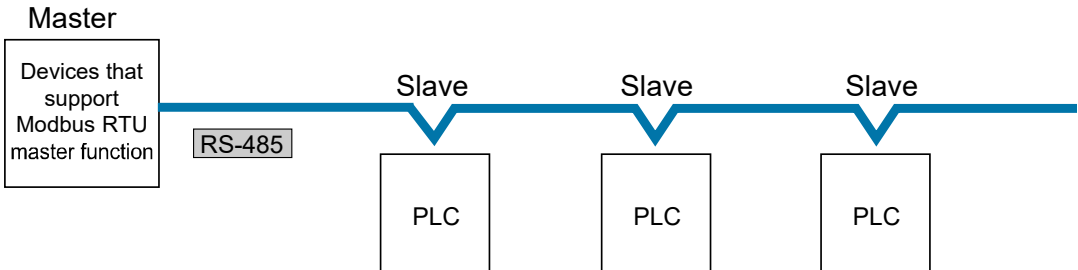

#### ■ Purpose of MODBUS-RTU master communication (example)

Used for connection with devices that support the MODBUS-RTU protocol.

- Temperature regulator KT series
- Devices that support MODBUS-RTU from other manufacturers

#### ■ Purpose of MODBUS-RTU slave communication (example)

Used for access from a higher device using MODBUS-RTU commands.

### 1.2.4 General-Purpose Communication

#### ■ Overview of function

- General-purpose communication is used when PLC performs communication in accordance with the protocol of the connected device.
- A user program should process the creation and transmission of command messages to connected devices, and the reception of responses therefrom. Data transmission / reception with external devices is handled through data registers and other given operation memories.
- For transmission, a command aligned to a connected device is ASCII converted into a string, and set to a given data register. The F159 (MTRN) instruction is executed to send a command.
- For reception, a response received from a connected device is temporarily stored in the buffer. The F159 (MTRN) instruction is executed to receive a response. The received ASCII string data is converted into numerical data, etc. based on a user program.
- The maximum data that can be sent at a time is 2,048 bytes (including control codes). The maximum data that can be received at a time is 4,096 bytes (including control codes).

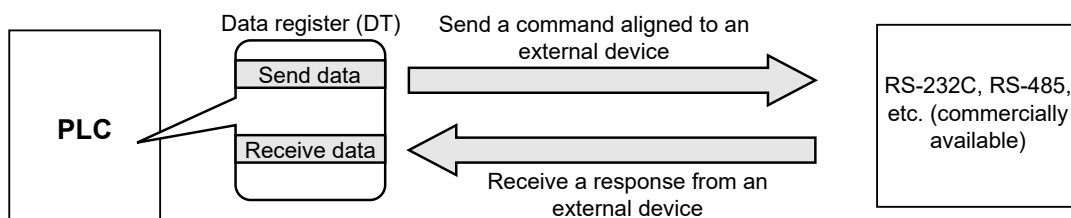

#### ■ Purpose of general-purpose communication

Used for connection with devices from other manufacturers that have specific communication protocols.

(MEMO)



## 2 Wiring of COM Port

---

2.1 Installation of Extension (Communication) Cassette .....	2-2
2.1.1 Precautions When Installing Extension (Communication) Cassette	2-2
2.1.2 Installing Extension (Communication) Cassette .....	2-2
2.2 Wiring of the COM Port Terminal Block .....	2-3
2.2.1 Suitable Wires and Tools .....	2-3
2.2.2 Applicable Cable .....	2-4
2.2.3 Wiring Method .....	2-4
2.3 Wiring of the Control Unit (GT Power Supply, COM0 Port) .....	2-6
2.3.1 Handling of GT Power Supply Terminal .....	2-6
2.3.2 Terminal Layout Diagrams and Wiring Examples .....	2-6
2.4 Wiring of COM Port of a Communication Cassette.....	2-8
2.4.1 AFP0HCCS1 (RS-232C 1ch Non-Insulated Type).....	2-8
2.4.2 AFP0HCCS2 (RS-232C 2ch Non-Insulated Type).....	2-9
2.4.3 AFP0HCCM1 (RS-485 1ch Insulated Type) .....	2-9
2.4.4 AFP0HCCS1M1 (RS-485 1ch insulated + RS-232C 1ch Non- Insulated Type) .....	2-10

## 2.1 Installation of Extension (Communication) Cassette

---

### 2.1 Installation of Extension (Communication) Cassette

#### 2.1.1 Precautions When Installing Extension (Communication) Cassette



- The installation must be carried out when the power supply is off. If the power supply is on, it may cause faults.
- Do not touch the back side of the extension (communication) cassette and the connector. The parts such as IC, etc. may be damaged by static electricity.

#### 2.1.2 Installing Extension (Communication) Cassette

One communication cassette can be attached to the control unit.

**1** 2

#### Procedure

1. Remove the cover on the side face of the unit with a slotted screwdriver. There are four tabs.

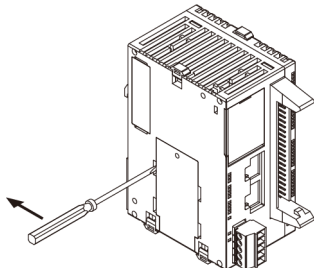

2. Install an arbitrary communication cassette.

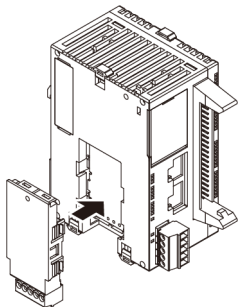

## 2.2 Wiring of the COM Port Terminal Block

### 2.2.1 Suitable Wires and Tools

The communication port has a screw-tightening type of terminal block. Use the following items for wiring.

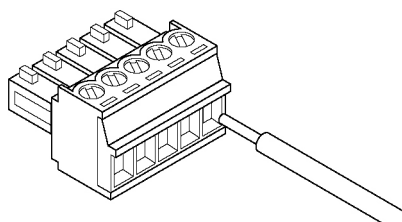

#### ■ Suitable wires (strand wire)

Size	Nominal cross-sectional area
AWG#28 to 16	0.08 mm <sup>2</sup> to 1.25 mm <sup>2</sup>

#### ■ Suitable pole terminals

If a pole terminal is used, the following models should be used.

Manufacturer	Cross-sectional area	Size	Part No.	
			With insulating sleeve	Without insulating sleeve
Phoenix Contact	0.25 mm <sup>2</sup>	AWG #24	AI 0,25 - 6 BU	A 0,25 - 7
	0.34 mm <sup>2</sup>	AWG #22	AI 0,34 - 6 TQ	A 0,34 - 7
	0.50 mm <sup>2</sup>	AWG #20	AI 0,5 - 6 WH	A 0,5 - 6
	0.75 mm <sup>2</sup>	AWG #18	AI 0,75 - 6 GY	A 0,75 - 6
	1.00 mm <sup>2</sup>	AWG #18	-	A 1 - 6

#### ■ Pressure welding tool for pole terminals

Manufacturer	Model No.	
	Part No.	Product No.
Phoenix Contact	CRIMPFOX 6	1212034

#### ■ Use a special tool to tighten the terminal block of a communication block

To tighten terminals, use a screwdriver from Phoenix Contact (model No. SZS 0,4 x 2,5, product No. 1205037, blade size 0.4 x 2.5) or a screwdriver from Panasonic (order No. AFP0806). The tightening torque should be 0.22 to 0.25 N·m.

## 2.2 Wiring of the COM Port Terminal Block

### 2.2.2 Applicable Cable

The following cables should be used.

#### ■ Suitable wires (strand wire): RS-485 communication wire

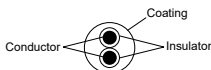
Classification	Cross-sectional view	Conductor		Insulator		Cable diam.	Sample appropriate cable
		Size	Resistance (at 20°C)	Material	Thickness		
Shielded twisted pair		1.25 mm <sup>2</sup> (AWG16) or more	Max. 16.8Ω/km	Polyethylene	Max. 0.5 mm	Approx. 8.5 mm	Sumiden Hitachi Cable KPEV-S1.25 mm <sup>2</sup> × 1P Belden Inc. 9860
		0.5mm <sup>2</sup> (AWG20) or more	Max. 33.4Ω/km	Polyethylene	Max. 0.5 mm		Approx. 7.8mm
VCTF		0.75mm <sup>2</sup> (AWG18) or more	Max. 25.1Ω/km	Polyvinylchloride	Max. 0.6mm	Approx. 6.6mm	VCTF0.75 mm <sup>2</sup> × 2C (JIS)

- Use shielded twisted pair cables.
- Use only one type of transmission cable. Do not mix more than 1 type.
- Twisted pair cables are recommended in noisy environments.
- For RS-485 transmission line, use crossover wiring, and ground one end of a shielded cable.
- If two wires are connected to the plus and minus terminals of RS-485, use wires of the same material and the same cross-sectional area between 0.5 and 0.75 mm<sup>2</sup>.

### 2.2.3 Wiring Method

#### ■ Wiring method

1. Remove a portion of the wire's insulation.

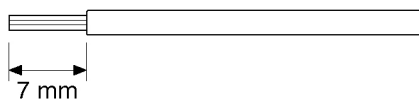

2. Insert wire into terminal hole until it stops. Tighten screw clockwise to fix wire in place. (Tightening torque: 0.22 N·m to 0.25 N·m)

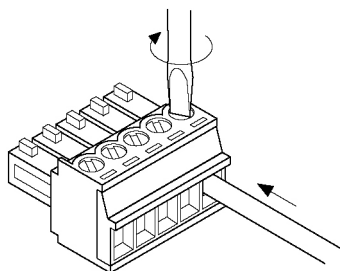

### ■ Precautions on wiring

The following precautions should be observed to avoid broken or disconnected wires.

- When removing the wire's insulation, be careful not to scratch the core wire.
- Do not twist the core wires to connect them.
- Do not solder the core wires to connect them. The solder may break due to vibration.
- After wiring, make sure stress is not applied to the wire.
- In the terminal block socket construction, if the wire is fastened upon counter-clockwise rotation of the screw, the connection is faulty. Disconnect the wire, check the terminal hole, and then re-connect the wire.

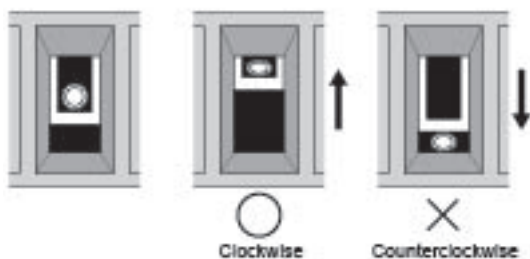

- If two wires are connected to the RS-485 terminal, use the same wire material of the same cross-sectional area ( $0.5 \text{ mm}^2$ ).

## 2.3 Wiring of the Control Unit (GT Power Supply, COM0 Port)

### 2.3 Wiring of the Control Unit (GT Power Supply, COM0 Port)

#### 2.3.1 Handling of GT Power Supply Terminal

A GT power supply terminal can be used as a power supply terminal for Panasonic programmable display GT02 / GT02L series.

##### ■ Displays that can be connected to the 5V power supply section

GT02 / GT02L series

Model	LCD	Power supply	Full-area panel cover	Communication port	Model No.
GT02M	STN monochrome LCD White / pink / red back light	5V DC	Black	RS-232C	AIG02MQ02D
				RS-422 / RS-485	AIG02MQ04D
			Silver	RS-232C	AIG02MQ03D
				RS-422 / RS-485	AIG02MQ05D
GT02G	STN monochrome LCD Green / orange / red back light	5V DC	Black	RS-232C	AIG02GQ02D
				RS-422 / RS-485	AIG02GQ04D
			Silver	RS-232C	AIG02GQ03D
				RS-422 / RS-485	AIG02GQ05D
GT02L	STN monochrome LCD White back light	5V DC	Black	RS-232C	AIG02LQ02D
				RS-422 / RS-485	AIG02LQ04D



- The GT power supply terminal (5V DC) is dedicated to the GT02 / GT02L series of Panasonic programmable displays. Do not connect it to other devices.

#### 2.3.2 Terminal Layout Diagrams and Wiring Examples

##### ■ Layout diagrams for GT power supply terminals and COM0 port terminals

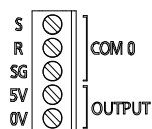

Indication on the unit		Description	
COM 0	S	Send data (unit → external device)	General-purpose RS-232C port of a 3-wire type
	R	Receive data (external device → unit)	
	SG	Signal Ground	
OUTPUT	5V	5V DC is outputted as power supply for a GT series display.	

## 2.3 Wiring of the Control Unit (GT Power Supply, COM0 Port)

Indication on the unit		Description
	0V	

### ■ Wiring example (connection with GT series, 5V type)

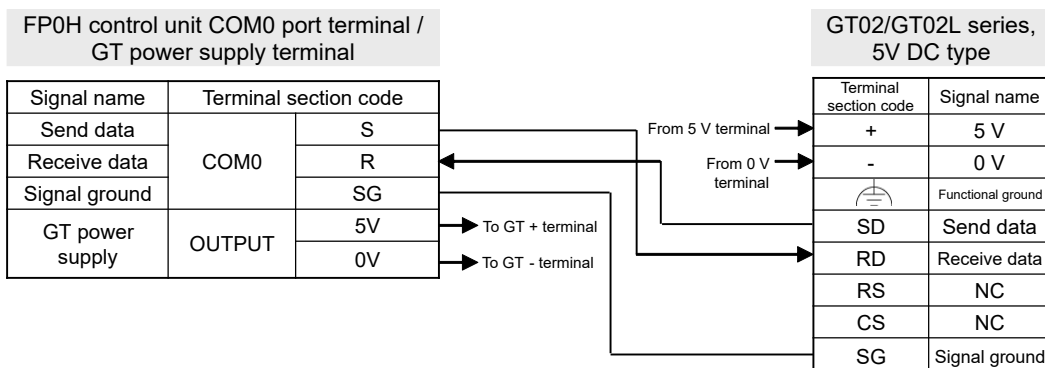

(Note 1) The terminal layout on the display side differs for the existing model GT01 series.

### ■ Wiring example (connection with GT series, 24V type)

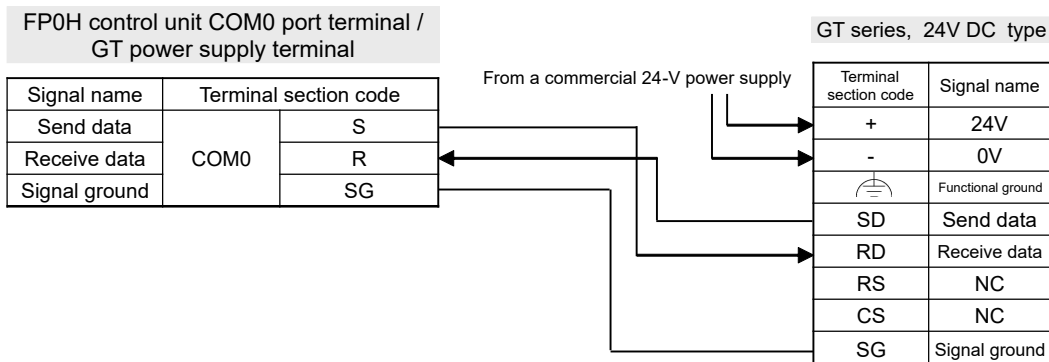

## 2.4 Wiring of COM Port of a Communication Cassette

### 2.4 Wiring of COM Port of a Communication Cassette

#### 2.4.1 AFP0HCCS1 (RS-232C 1ch Non-Insulated Type)

##### Terminal layout

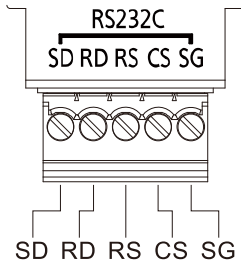

Terminal code	Allocated function	Signal direction	LED	Port allocated on the software
SD	SD: Send Data	PLC → External device	S1	COM1
RD	RD: Receive Data	PLC ← External device	R1	
RS	RS: Request to Send	PLC → External device	S2	
CS	CS: Clear to Send	PLC ← External device	R2	
SG	SG: Signal Ground	-	-	

(Note 1) RS (Request to Send) is controlled by SYS1 instruction.

(Note 2) Data cannot be sent without a CS (Clear to Send) signal. When using it as a 3-wire type, short-circuit RS and CS.

(Note 3) LED (S2) flashes during RS transmission, and LED (R2) flashes during CS reception.

##### Example of wiring

AFP0HCCS1

Pin name	Signal name	Abbr.
SD	Send data	SD
RD	Receive data	RD
RS	Request to Send	RS
CS	Clear to Send	CS
SG	Signal ground	SG

Connect to

Code	Signal name
RD	Receive data
SD	Send data
CS	Clear to Send
RS	Request to Send
SG	Signal ground

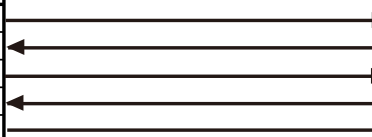



### 2.4.2 AFP0HCCS2 (RS-232C 2ch Non-Insulated Type)

#### ■ Terminal layout

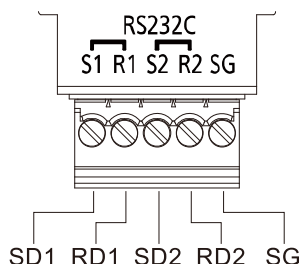

Terminal code	Allocated function	Signal direction	LED	Port allocated on the software
S1	SD: Send Data	PLC → External device	S1	COM1
R1	RD: Receive Data	PLC ← External device	R1	
S2	SD: Send Data	PLC → External device	S2	COM2
R2	RD: Receive Data	PLC ← External device	R2	
SG	SG: Signal Ground	-	-	-

#### ■ Example of wiring

AFP0HCCS2

Pin name	Signal name	Abbr.
S1	Send data 1	SD
R1	Receive data 1	RD
S2	Send data 2	SD
R2	Receive data 2	RD
SG	Signal ground	SG

Connection destination 1

Code	Signal name
RD	Receive data
SD	Send data
SG	Signal ground

Connection destination 2

Code	Signal name
RD	Receive data
SD	Send data
SG	Signal ground

### 2.4.3 AFP0HCCM1 (RS-485 1ch Insulated Type)

#### ■ Setting of cassette backside switch

A termination resistance selector switch for RS-485 interface is located on communication cassette AFP0HCCM1. Turn ON this switch only when it is the end unit. An equivalent circuit diagram is indicated below.

## 2.4 Wiring of COM Port of a Communication Cassette

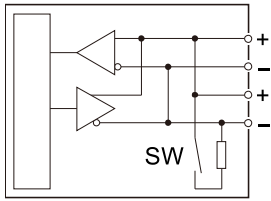

### Terminal layout

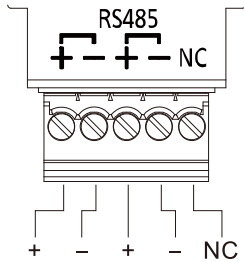

Terminal code	Allocated function	LED	Port allocated on the software
+	Transmission line (+)	S1 R1	COM1
-	Transmission line (-)		
+	Transmission line (+)		
-	Transmission line (-)		
N.C.	-	-	-

### Example of wiring

AFP0HCCM1

Pin name	Signal name	Abbr.
+	Transmission line (+)	
-	Transmission line (-)	
+	Transmission line (+)	
-	Transmission line (-)	
N.C.		

Connection destination 1

Code	Signal name
+	Transmission line (+)
-	Transmission line (-)

(To another device)

Connection destination 2

Code	Signal name
+	Transmission line (+)
-	Transmission line (-)

(To another device)

### 2.4.4 AFP0HCCS1M1 (RS-485 1ch insulated + RS-232C 1ch Non-Insulated Type)

#### Setting of cassette backside switch

A termination resistance selector switch for RS-485 interface is located on communication cassette AFP0HCCS1M1. Turn ON this switch only when it is the end unit. An equivalent circuit diagram is indicated below.

## 2.4 Wiring of COM Port of a Communication Cassette

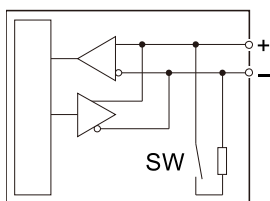

### Terminal layout

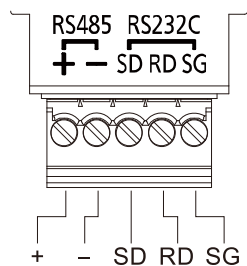

Terminal code	Allocated function	Signal direction	LED	Port allocated on the software
+	Transmission line (+)	-	S1	COM1
-	Transmission line (-)	-	R1	
SD	Send Data	PLC → External device	S2	COM2
RD	Receive data	PLC ← External device	R2	
SG	Signal Ground	-	-	

### Example of wiring

AFP0HCCS1M1

Pin name	Signal name	Abbr.
+	Transmission line (+)	+
-	Transmission line (-)	-
SD	Send data	SD
RD	Receive data	RD
SG	Signal ground	SG

Connection destination 1

Code	Signal name
+	Transmission line (+)
-	Transmission line (-)

(To another device)

Connection destination 2

Code	Signal name
RD	Receive data
SD	Send data
SG	Signal ground

(MEMO)

# 3 Setting and Confirmation of Communication Conditions

---

3.1 Setting of Purpose and Communication Conditions .....	3-2
3.1.1 Purpose to be Set for Each Port .....	3-2
3.1.2 Communication Conditions to be Set for Each Port.....	3-2
3.2 Communication Conditions Settings .....	3-4
3.2.1 System Register Settings.....	3-4
3.2.2 Settings Using a Program .....	3-4

## 3.1 Setting of Purpose and Communication Conditions

### 3.1 Setting of Purpose and Communication Conditions

#### 3.1.1 Purpose to be Set for Each Port

- List of available functions by communication port (●: Available; ○: Conditional; Blank : Not available)

Available communication functions		Main unit	Cassette	
		COM0	COM1	COM2
PLC link		○	○	
MEWTOCOL-COM	Master	●	●	●
	Slave	●	●	●
MODBUS-RTU	Master	●	●	●
	Slave	●	●	●
General-purpose communication		●	●	●

(Note 1) For PLC link, only one port may be used (either COM0 port that is built in the control unit as standard equipment, or COM1 port on a cassette).

#### 3.1.2 Communication Conditions to be Set for Each Port

Communication conditions that can be set vary by the mode to be used.

- Communication condition

Communication port		Setting range	Default	Remark
Unit number		1 to 99	1	
Communication mode		Computer link, general-purpose communication, PLC link, MODBUS RTU	Computer link	
Modem connection		Invalid / valid	Invalid	For computer link only
Baud rate		1200, 2400, 4800, 9600, 19200, 38400, 57600, 115200, 230400	9600	(Note 3)(Note 4) (Note 5)
Transmission format	Data length	7 bits, 8 bits	8 bits	
	Parity	None, Odd, Even	Odd	
	Stop bit	1 bit, 2 bits	1 bit	
	Terminator	CR, CR+LF, ETX, time Terminator judgment time (Note 1)	CR	For general-purpose communication only
	Header	No STX / STX	No STX	
Receive buffer starting number in general-purpose communication		DT0 to DT32764 (Note 2)	Depends on port No.	

## 3.1 Setting of Purpose and Communication Conditions

---

Communication port	Setting range	Default	Remark
Receive buffer capacity in general-purpose communication	0 to 2048	2048	

(Note 1) For terminator (end code) judgment time, select 0.01 ms to 100 ms (by 0.01 ms), or transfer time of approx. 4 characters.

(Note 2) Receive buffer starting number in general-purpose communication varies by the value of system register No.0.

(Note 3) A baud rate of 1200 bps can only be set using SYS1 instruction. (This cannot be set using system registers.)

(Note 4) If the baud rate is changed as below, communications passing through all COM ports will be reset.  
Baud rates of all COM ports: 4800 bps or higher ↔ Baud rate of any of the COM ports: 2400 bps or lower

(Note 5) If the baud rate of any of the COM ports is 2400 bps or lower, F-ROM access will slow down.  
Example) F12(ICRD) instruction, P13(ICWT) instruction, etc.

## 3.2 Communication Conditions Settings

### 3.2 Communication Conditions Settings

#### 3.2.1 System Register Settings

Purposes and communication conditions of each communication port should be set using tool software.

#### 1 2 Procedure

1. Select **Option>System register settings** from the menu bar.  
The "PLC Configuration" dialog box opens.
2. Select any "COM Port" setting in the left pane.  
Setting items for communication conditions are displayed.

The screenshot shows the "PLC Configuration" dialog box. On the left, a tree view lists various settings, with "COM0 Port" highlighted. The main area contains several configuration fields:

- No. 410 Unit No.: 1
- No. 412 Communication Mode: Computer Link
- Modem Enabled:
- No. 48 PLC link Baud rate: 115200bps
- No. 415 Baud rate: 9600 bps
- No. 413 Communication Format:
  - Char. Bit: 8 bits
  - Parity: Odd
  - Stop Bit: 1
  - Terminator slt: Code
  - Terminator: CR
  - Header: STX Not Exist.
- No. 420 Starting address for data received of serial data communication mode: DT 4096 (0 - 32764)
- No. 421 Buffer capacity setting for data received of serial data communication mode: 2048 (0 - 2048)
- No. 424 Terminator judgement time (X0.01 msec): 0 (0 - 10000)

Buttons at the bottom: OK, Cancel, Read PLC, Initialize.

3. Set communication conditions, and press [OK].  
The set conditions are reflected in the program being edited.

#### 3.2.2 Settings Using a Program

Purposes and communication conditions of each communication port may also be specified using system register setting instruction SYS1.

##### ■ Sample program

This is a program that changes the transmission format, baud rate, and unit numbers of COM1 port.



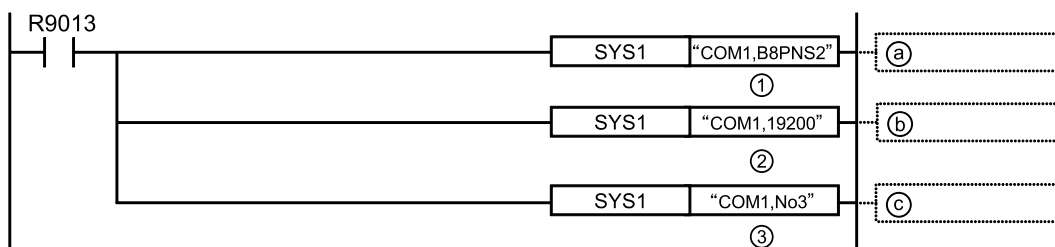

(a)	Set the transmission format of COM1 port to "Data length: 8 bits; Parity: None; Stop bit: 2".
(b)	Set the baud rate of COM1 port to 19200 bps.
(c)	Set the unit No. of COM1 port to No.3.

### ■ Input by using FPWIN GR7

Input into an operand of SYS1 instruction should be performed as a string. A string that indicates a port and a string that indicates a parameter should be separated by ", (comma)". On FPWIN GR7, an inputted character constant is bracketed by double quotation marks.

#### Example: when a transmission format is specified

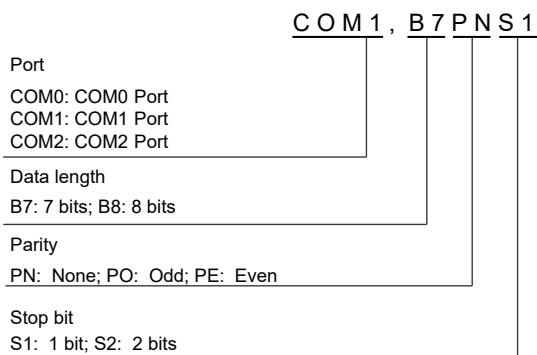

(Note): For details of instruction programming, refer to the FP series Programming Manual.

(MEMO)

# 4 PLC link

---

4.1 Operation of PLC Link MEWNET-W0 .....	4-2
4.1.1 Operation Overview of PLC Link.....	4-2
4.1.2 Roles of Link Relays and Link Registers .....	4-2
4.2 Setting Items for PLC Link .....	4-4
4.2.1 Unit Number Setting.....	4-4
4.2.2 Setting of the Largest Unit Number.....	4-4
4.2.3 Memory Block No. of Link Relays and Link Registers to be Used ...	4-4
4.2.4 Ranges of Link Relays and Link Registers to be Used.....	4-5
4.2.5 Link Relay Transmission Start Number and Sending Size .....	4-5
4.2.6 Link Register Transmission Start Number and Sending Size .....	4-6
4.3 Response Time of PLC Link .....	4-9
4.3.1 Response Time of One Transmission Cycle.....	4-9
4.3.2 Response Time when There are Units that have not been Added to the Link .....	4-10

## 4.1 Operation of PLC Link MEWNET-W0

### 4.1 Operation of PLC Link MEWNET-W0

#### 4.1.1 Operation Overview of PLC Link

- “Link relays (L)” and data registers “link registers (LD)” are shared between connected PLCs.
- In the case of link relays, if the link relay contact of one PLC turns ON, the same link relays also turn ON in all PLCs on the same network.
- Likewise, in the case of link registers, if the content of a link register in one PLC is rewritten, the value of the same link register is changed in all PLCs on the same network.

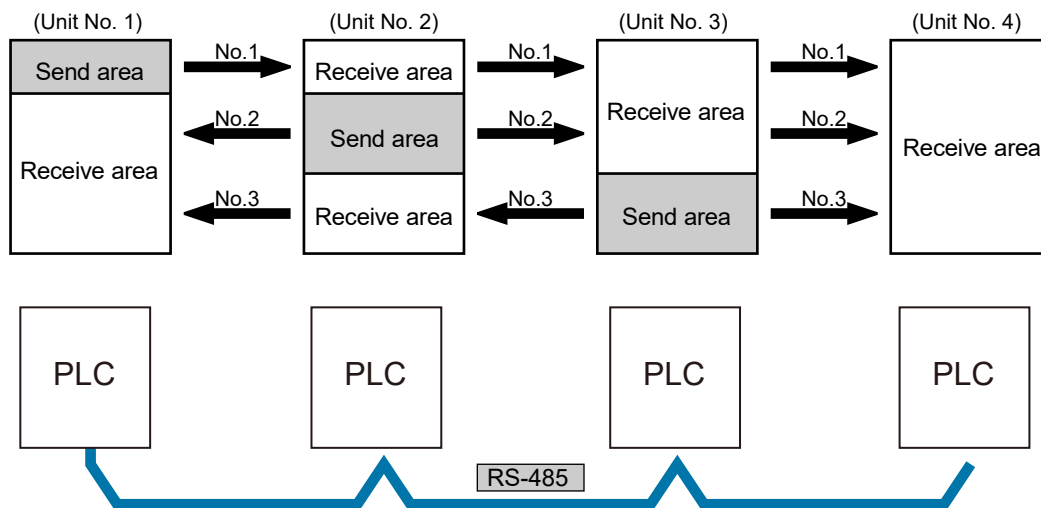

#### 4.1.2 Roles of Link Relays and Link Registers

##### ■ Link relay

If link relay L0 in the master unit (No.1) is turned ON, the state change is fed back to link relay L0 that has the same number in other units, and R0 is outputted from these units.

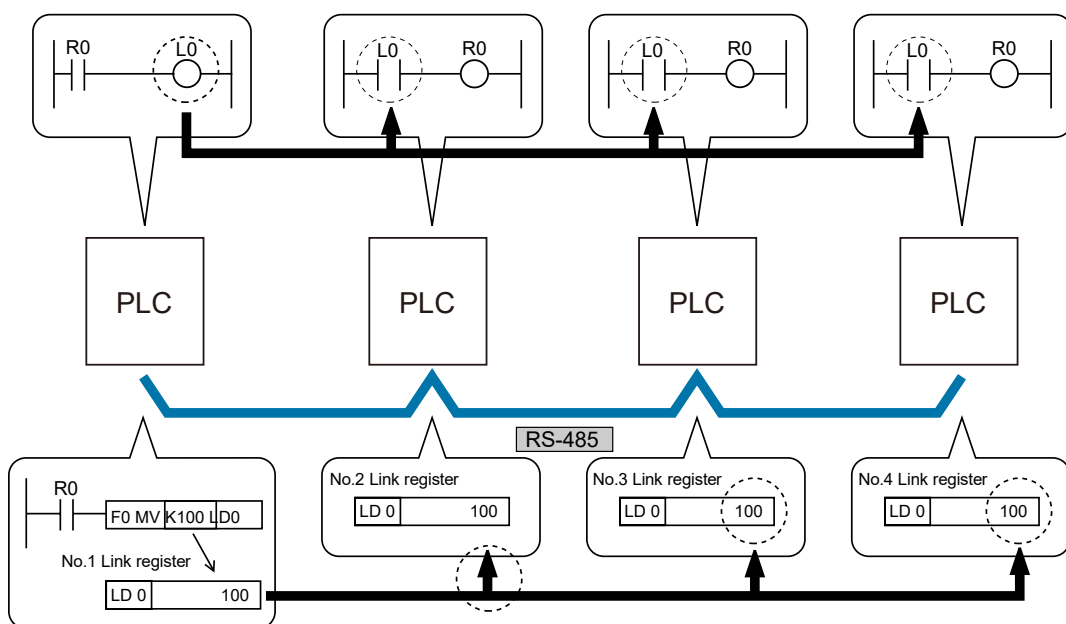

### ■ Link register

When a constant 100 is written into LD0 of the master unit (No. 1), the content of LD0 of every other unit is also changed to constant 100.

## 4.2 Setting Items for PLC Link

### 4.2 Setting Items for PLC Link

#### 4.2.1 Unit Number Setting

- In a PLC link that connects multiple PLCs on the same transmission line, a unit number must be assigned to each PLC for identification.
- A unit number is a unique number used to identify PLCs on a network. The same number must not be used for more than one PLC on the same network.

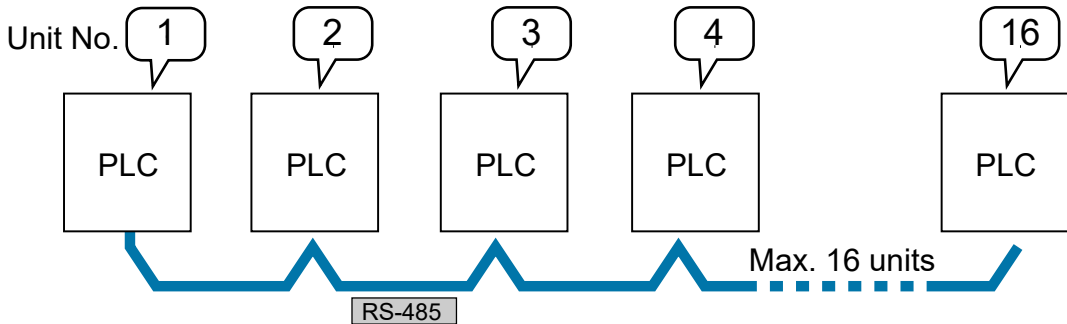

#### 4.2.2 Setting of the Largest Unit Number

- Specify the largest PLC unit number used for PLCs connected to the PLC link.
- The smaller unit numbers are, the relatively shorter transmission time is required.



- Unit numbers should be set sequentially and consecutively, starting from 1, with no breaks between them. If there is a missing unit number, the transmission time will be longer.
- Specify the same value as the largest PLC unit number for all units connected in a PLC link.

#### 4.2.3 Memory Block No. of Link Relays and Link Registers to be Used

- The memory areas of link relays and link registers are divided for PLC link 0 and for PLC link 1. Either area can be selected, and max. 1024 points (64 words) can be used for link relays, and max. 128 words can be used for link registers.
- Specify "0" for using memory blocks in the first half, and "1" for using memory blocks in the latter half.

### Structure of a link area

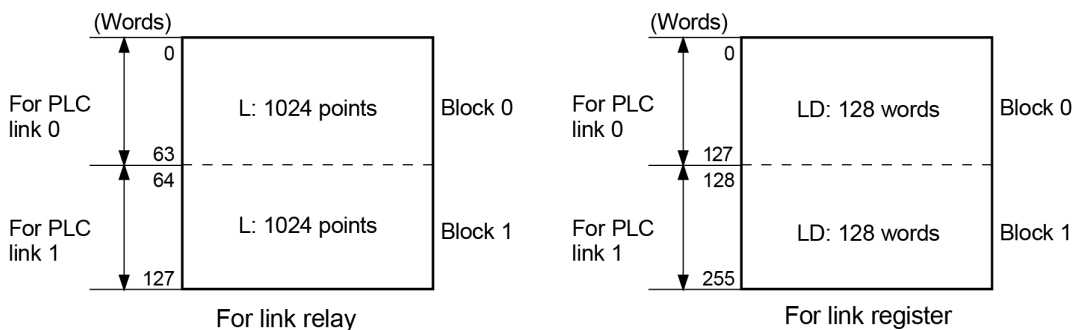

#### 4.2.4 Ranges of Link Relays and Link Registers to be Used

- Specify the ranges of memory areas of link relays and link registers to be actually used.
- Link relays and link registers that are not to be used for linking may be used in place of internal relays and data registers.

#### Example) Setting of ranges for use (in the case of PLC link 0)

- The diagram below indicates a case when “50” (50 words from WL0 to WL49) is specified for the range of link relay, and “100” (100 words from LD0 to LD99) for the range of link register to be used.

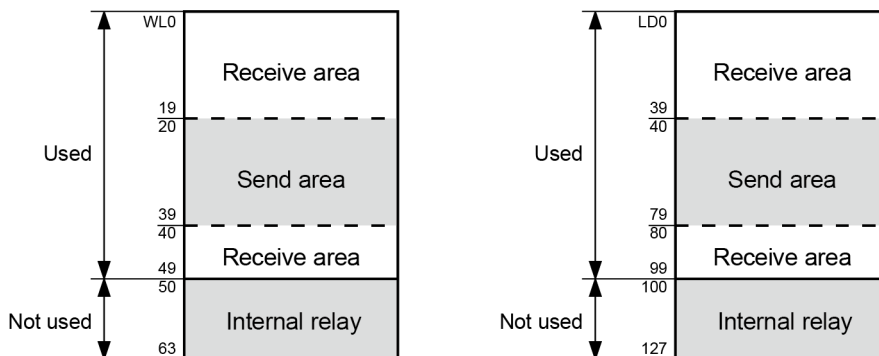

- As the range to be used in PLC link 0, specify “64” (64 words) when all link relays are to be used, and “128” (128 words) when all link registers are to be used.

#### 4.2.5 Link Relay Transmission Start Number and Sending Size

- The memory areas of link relays are divided into send areas and receive areas.
- Link relays are transmitted from the send area of a PLC to the receive area of another PLC. The receiving PLC must have the same link relay No. in its receive area as the sending PLC.

## 4.2 Setting Items for PLC Link

**Example) Setting of the link relay transmission start number and sending size (in the case of memory block No. 0)**

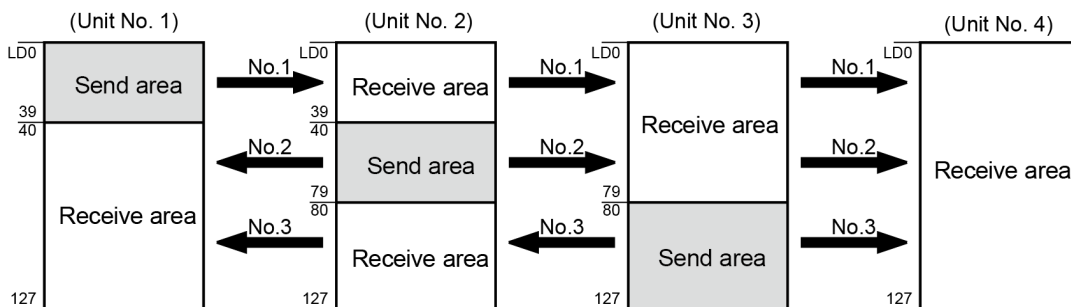

### ■ List of setting items (for PLC link setting)

Setting item	Setting range	Unit No. and setting method			
		No.1	No.2	No.3	No.4
Memory block No. of link relays and link registers to be used	0 or 1	0	0	0	0
Max. unit No. used for PLC link	0 to 16	4	4	4	4
Range of link relays used	0 to 64 words	64	64	64	64
Transmission start No. for link relays	0 to 63	0	20	40	0
Size of link relay send area	0 to 64 words	20	20	24	0

## 4.2.6 Link Register Transmission Start Number and Sending Size

- The memory areas of link registers are divided into send areas and receive areas.
- Link registers are transmitted from the send area of a PLC to the receive area of another PLC. The receiving PLC must have the same link register No. in its receive area as the sending PLC.

**Example) Setting of the link register transmission start number and sending size (in the case of memory block No. 0)**

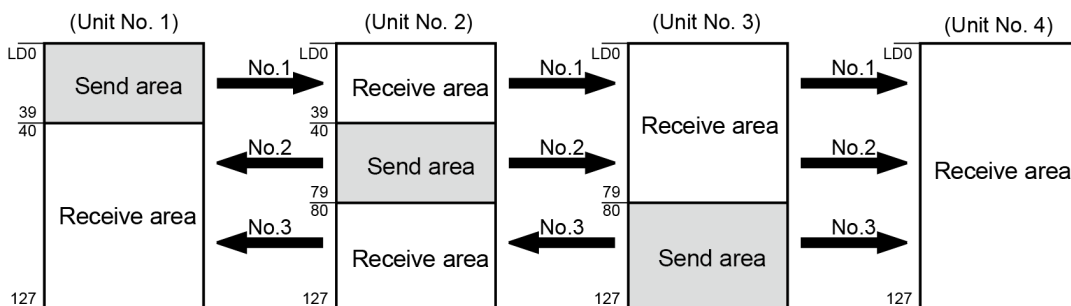



## ■ List of setting items (for PLC link setting)

Setting item	Setting range	Unit No. and setting method			
		No.1	No.2	No.3	No.4
Memory block No. of link relays and link registers to be used	0 or 1	0	0	0	0
Max. unit number used for PLC link	0 to 16	4	4	4	4
Range of link registers used	0 to 128 words	128	128	128	128
Transmission start no. for link registers	0 to 127	0	40	80	0
Size of link register send area	0 to 127 words	40	40	48	0

## 4.2 Setting Items for PLC Link

- If a mistake is made when allocating a link area, be aware that an error will result, and communication will be disabled.
- Avoid overlapping send areas.

In the following example, there is an overlapping area between link relays No. 2 and 3. This will cause an error and disable communication.

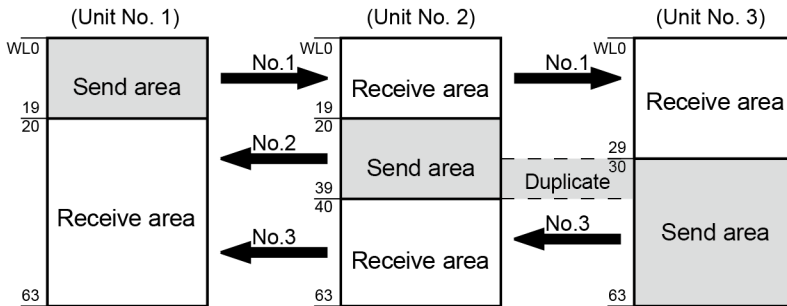

- Allocations as shown below are not possible for link relays or for link registers:

Send area is split in a PLC

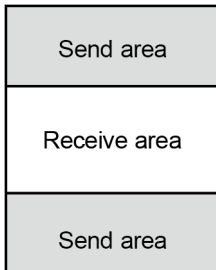

Send and receive areas are split into multiple segments

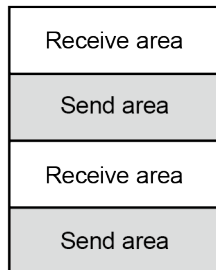
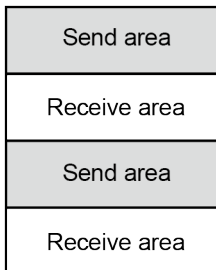

## 4.3 Response Time of PLC Link

### 4.3.1 Response Time of One Transmission Cycle

The maximum value of one transmission cycle time (T) can be calculated using the following formula.

#### ■ Calculation formula

$$T_{max.} = \underbrace{T_{s1} + T_{s2} + \dots + T_{sn}}_{(1) \text{ } T_s \text{ (transmission time per unit)}} + \underbrace{T_{lt}}_{(2) \text{ } T_{lt} \text{ (link table sending time)}} + \underbrace{T_{so}}_{(3) \text{ } T_{so} \text{ (master unit scan time)}} + \underbrace{T_{lk}}_{(4) \text{ } T_{lk} \text{ (link addition processing time)}}$$

#### (1) Ts (transmission time per unit)

Calculation formula	$T_s = \text{Scan time} + T_{pc}$ (PLC link sending time)
	$T_{pc} = T_{tx}$ (sending time per byte) $\times$ $P_{cm}$ (PLC link sending byte size) $T_{tx} = 1 / (\text{baud rate kbps} \times 1000) \times 11 \text{ ms}$ ... approx. 0.096 ms when 115.2 kbps $P_{cm} = 23 + (\text{number of relay words} + \text{number of register words}) \times 4$ (an ASCII code needs multiplication by four)

#### (2) Tlt (link table sending time)

Calculation formula	$T_{lt} = T_{tx}$ (sending time per byte) $\times$ $L_{tm}$ (link table sending size)
	$T_{tx} = 1 / (\text{baud rate kbps} \times 1000) \times 11 \text{ ms}$ ... approx. 0.096ms when 115.2 kbps $L_{tm} = 13 + 2 \times n$ (n = No. of added units)

#### (3) Tso (master unit scan time)

To be checked using tool software.

#### (4) Tlk (link addition processing time)

Calculation formula	If all units have been added, $T_{lk} = 0$ $T_{lk} = T_{lc}$ (link addition command sending time) + $T_{wt}$ (addition waiting time) + $T_{ls}$ (sending time for command to stop transmission if link error occurs) + $T_{so}$ (master unit scan time)
	$T_{lc} = 10 \times T_{tx}$ (sending time per byte) $T_{tx} = 1 / (\text{baud rate kbps} \times 1000) \times 11 \text{ ms}$ ... approx. 0.096 ms when 115.2 kbps $T_{wt} = \text{initial value } 400 \text{ ms}$ $T_{ls} = 7 \times T_{tx}$ (sending time per byte) $T_{tx} = 1 / (\text{baud rate kbps} \times 1000) \times 11 \text{ ms}$ ... approx. 0.096ms when 115.2 kbps $T_{so} = \text{master unit scan time}$

#### ■ Calculation example

	Condition	Calculation process	One transmission cycle time (T)
1	16-unit link with all units added Max. unit number = 16	$T_{tx}=0.096$ Each $P_{cm}=23+(4+8) \times 4=71$ bytes	$T_{max.}=T_s+T_{lt}+T_{so}$ $7.82 \times 16+4.32+1$

### 4.3 Response Time of PLC Link

	Condition	Calculation process	One transmission cycle time (T)
	Relays / registers are evenly allocated, and Each PLC scan time = 1 ms	$T_{pc} = T_{tx} \times P_{cm} = 0.096 \times 71 \approx 6.82$ ms Each $T_s = 1 + 6.82 = 7.82$ ms $T_{lt} = 0.096 \times (13 + 2 \times 16) = 4.32$ ms	=130.44 ms
2	16-unit link with all units added Max. unit number = 16 Relays / registers are evenly allocated Each PLC scan time = 5 ms	$T_{tx} = 0.096$ Each $P_{cm} = 23 + (4 + 8) \times 4 = 71$ bytes $T_{pc} = T_{tx} \times P_{cm} = 0.096 \times 71 \approx 6.82$ ms Each $T_s = 5 + 6.82 = 11.82$ ms $T_{lt} = 0.096 \times (13 + 2 \times 16) = 4.32$ ms	$T_{max.} = T_s + T_{lt} + T_{so}$ $11.82 \times 16 + 4.32 + 5$ =198.44 ms
3	16-unit link with one unit unadded, Max. unit number = 16 Relays / registers are evenly allocated Each PLC scan time = 5 ms	$T_{tx} = 0.096$ Each $T_s = 5 + 6.82 = 11.82$ ms $T_{lt} = 0.096 \times (13 + 2 \times 15) \approx 4.13$ ms $T_{lk} = 0.96 + 400 + 0.67 + 5 \approx 407$ ms Note: addition waiting time default value = 400 ms	$T_{max.} = T_s + T_{lt} + T_{so} + T_{lk}$ $11.82 \times 15 + 4.13 + 5 + 407$ =593.43 ms
4	8-unit link with all units added Max. unit number = 8 Relays / registers are evenly allocated Each PLC scan time = 5 ms	$T_{tx} = 0.096$ Each $P_{cm} = 23 + (8 + 16) \times 4 = 119$ bytes $T_{pc} = T_{tx} \times P_{cm} = 0.096 \times 119 \approx 11.43$ ms Each $T_s = 5 + 11.43 = 16.43$ ms $T_{lt} = 0.096 \times (13 + 2 \times 8) \approx 2.79$ ms	$T_{max.} = T_s + T_{lt} + T_{so}$ $16.438 + 2.79 + 5$ =139.23 ms
5	2-unit link with all units added Max. unit number. = 2 Relays / registers are evenly allocated Each PLC scan time = 5 ms	$T_{tx} = 0.096$ Each $P_{cm} = 23 + (32 + 64) \times 4 = 407$ bytes $T_{pc} = T_{tx} \times P_{cm} = 0.096 \times 407 \approx 39.072$ ms Each $T_s = 5 + 39.072 = 44.072$ ms $T_{lt} = 0.096 \times (13 + 2 \times 2) \approx 1.632$ ms	$T_{max.} = T_s + T_{lt} + T_{so}$ $44.072 \times 2 + 1.632 + 5$ =94.776 ms
6	2-unit link with all units added Max. unit number = 2 Relay 32 points / register 2W are evenly allocated Each PLC scan time = 1 ms	$T_{tx} = 0.096$ Each $P_{cm} = 23 + (1 + 1) \times 4 = 31$ bytes $T_{pc} = T_{tx} \times P_{cm} = 0.096 \times 31 \approx 2.976$ ms Each $T_s = 1 + 2.976 = 3.976$ ms $T_{lt} = 0.096 \times (13 + 2 \times 2) \approx 1.632$ ms	$T_{max.} = T_s + T_{lt} + T_{so}$ $3.976 \times 2 + 1.632 + 1$ =10.584 ms

#### 4.3.2 Response Time when There are Units that have not been Added to the Link

- If there is an unadded unit,  $T_{lk}$  (link addition processing time) becomes longer, and makes transmission cycle time longer.

$$T_{max.} = T_{s1} + T_{s2} + \dots + T_{sn} + T_{lt} + T_{so} + T_{lk}$$

$$T_{lk} = T_{lc} \text{ (link addition command sending time)} + T_{wt} \text{ (addition waiting time)} + T_{ls} \text{ (sending time for command to stop transmission if link error occurs)} + T_{so} \text{ (master unit scan time)}$$

#### Info.

- “Unadded unit” refers to a unit that is not connected between unit No. 1 and the largest unit number, or to a unit that is connected but has not powered ON.

# 5 MEWTOCOL Master-Slave Communication

---

5.1 List of MEWTOCOL Supported Commands .....	5-2
5.1.1 List of MEWTOCOL-COM Commands .....	5-2
5.2 MEWTOCOL-COM Master Communication (RECV).....	5-3
5.2.1 For Type without Ethernet Function .....	5-3
5.2.2 For Type with Ethernet Function .....	5-5
5.3 MEWTOCOL-COM Master Communication (SEND).....	5-8
5.3.1 For Type without Ethernet Function .....	5-8
5.3.2 For Type with Ethernet Function .....	5-10

## 5.1 List of MEWTOCOL Supported Commands

### 5.1 List of MEWTOCOL Supported Commands

#### 5.1.1 List of MEWTOCOL-COM Commands

##### ■ Commands to be used

Type of instruction	Code	Description
Read contact area	RC (RCS) (RCP) (RCC)	Reads contact ON/OFF status. <ul style="list-style-type: none"><li>• Specifies only a single contact.</li><li>• Specifies multiple contacts.</li><li>• Specifies a range in word units.</li></ul>
Write contact area	WC (WCS) (WCP) (WCC)	Turns contact ON or OFF. <ul style="list-style-type: none"><li>• Specifies only a single contact.</li><li>• Specifies multiple contacts.</li><li>• Specifies a range in word units.</li></ul>
Read data area	RD	Reads the contents of a data area.
Write data area	WD	Writes data to a data area.
Register / reset contacts monitored	MC	Registers the contact to be monitored.
Register / reset data monitored	MD	Registers the data to be monitored.
Monitoring start	MG	Monitors a registered contact or data using MD and MC.
Preset contact area (fill command)	SC	Fills the area of a specified range with a 16-point ON / OFF pattern.
Preset data area (fill command)	SD	Writes the same contents to the data area of a specified range.
Read the status of PLC	RT	Reads PLC specification, an error code when an error occurs, etc.
Abort	AB	The reception of multi-frame response is aborted.

(Note 1) Some devices cannot be accessed due to format limitations of MEWTOCOL-COM communication commands.

#### Info.

- For more details of MEWTOCOL command, refer to "[10.6 MEWTOCOL-COM Format](#)".

## 5.2 MEWTOCOL-COM Master Communication (RECV)

### 5.2.1 For Type without Ethernet Function

#### ■ Procedure

PLC has the transmission right in master communication, and master communication is performed by sending commands to, and receiving responses from, devices that support MEWTOCOL. Data can be read by specifying unit numbers and memory addresses and executing F146 (RECV) instruction in a user program, because PLC automatically creates messages according to the protocol.

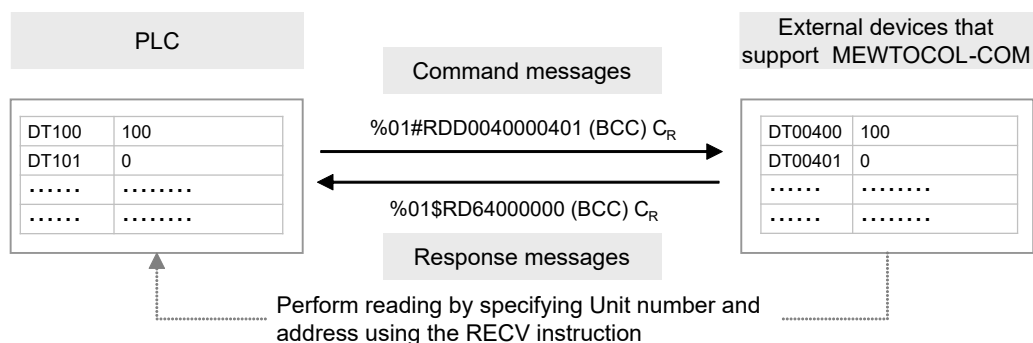

#### ■ Sample program

- Send a command from the COM1 port of the unit, read data from the data areas DT400 to DT401 of an external device (unit No. 1), and write the data into the data registers DT100 to DT101 of PLC.
- Confirm that transmission is not in progress (SEND/RECV instruction execution flag R913C: ON) for the same port, and start up SEND instruction.
- F146 (RECV) instruction is executed by specifying the transfer method (word transfer / bit transfer), the number of words, unit number of a destination unit, starting address, and the starting address of PLC memory area that stores data. Also specify the bit Nos. of both sides in the case of bit transfer.

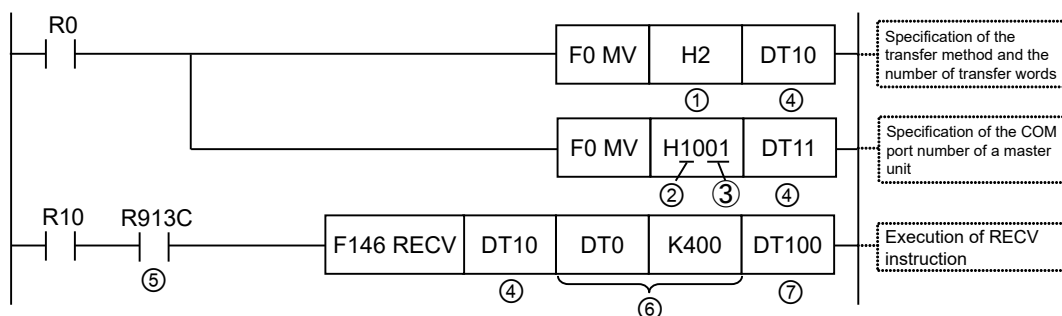

(Note 1) The slave side may not be able to respond, when the scan time of PLC as a master unit is short and interval between transmission sessions is short. In such cases, insert a timer instruction into the execution conditions for instructions, and make the sending interval longer.

## 5.2 MEWTOCOL-COM Master Communication (RECV)

Code	Description	
(1)	Transfer method and the number of transfer words	Specify the number of words in higher words of control data. Range: H1 to H1FD (1 word to 509 words)
(2)	COM port No. of a master unit	Specify a COM port No. for the higher 4 bits in lower words of control data. HF: COM0 port; H1: COM1 port; H2: COM2 port
(3)	Unit number of a destination unit	Specify a unit number of a destination unit for the lower 8 bits in lower words of control data. Range: H01 to H63 (K1 to K99)
(4)	Memory area to store control data	Specify the starting number of the area (2 words) that specifies the transfer method and the number of transfer data.
(5)	SEND/RECV instruction execution flag	This is inserted to confirm that no SEND / RECV instruction is in progress for the same port. Turns ON when an instruction is executable.
(6)	Destination unit send data storage area	Using two operands, specify the type and relative address of the memory area of a destination unit that stores receive data.
(7)	Master unit memory area to store receive data	Specify the memory area of the master unit that stores receive data.

(Note 1) For details of instruction programming, refer to "8.1.3 F146 REC [MEWTOCOL Master Receiver (Serial Communication)]".

### Info.

- Other F145 (SEND) / F146 (RECV) instructions cannot be executed at the same time to a communication port during master communication. Confirm that the "SEND/RECV instruction execution flag" is ON, and execute the instructions.
- F145 (SEND) / F146 (RECV) instruction cannot be executed at the same time to a port during slave communication.
- The processing of F145 (SEND)/F146 (RECV) instruction is handled during the execution of ED instruction. Check the SEND/RECV instruction execution end flag to confirm the completion of transmission / reception. Turned ON in the case of an error, and an error code is stored in DT90123-DT90125. (Example: !61 Data error = H61)  
For details of error codes, refer to "10.5.1 List of MEWTOCOL-COM/DAT Communication Error Codes".
- In the case of COM0 port, specify "HF" as a COM port No. for an operand of the F145 (SEND) / F146 (RECV) instruction.

### ■ Special relays / special data registers

	COM0	COM1	COM2
SEND/RECV instruction execution flag	R9134	R913C (R9044)	R9144 (R904A)
SEND/RECV instruction execution end flag	R9135	R913D (R9045)	R9145 (R904B)
SEND/RECV instruction end code	DT90123	DT90124	DT90125

(Note 1) The Nos. in brackets indicate devices that are compatible with existing FP-X / FPsigma.



### 5.2.2 For Type with Ethernet Function

#### ■ Procedure

PLC has the transmission right in master communication, and master communication is performed by sending commands to, and receiving responses from, devices that support MEWTOCOL. Data can be read by specifying unit numbers and memory addresses and executing F146 (RECV) instruction in a user program, because PLC automatically creates messages according to the protocol.

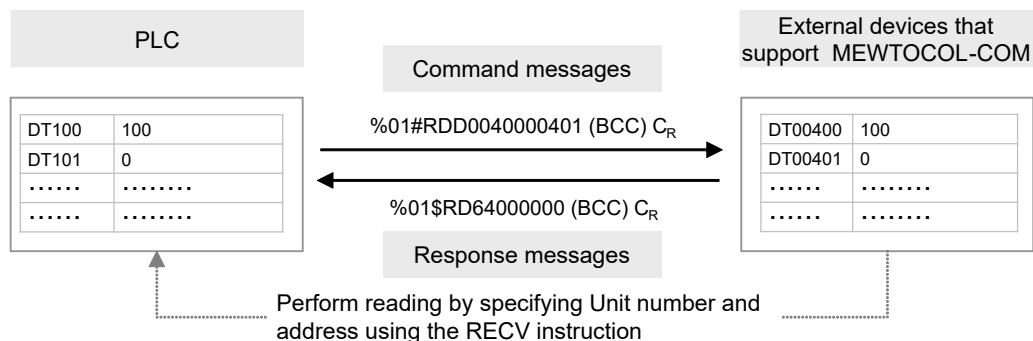

- When using both the serial communication and Ethernet communication within a program, specify the serial communication port using the F469 (UNITSEL) instruction before executing the F146 (RECV) instruction.

#### ■ Sample program

- Send a command from the COM1 port of the unit, read data from the data areas DT400 to DT401 of an external device (unit No. 1), and write the data into the data registers DT100 to DT101 of PLC.
- Confirm that transmission is not in progress (SEND/RECV instruction execution flag R913C: ON) for the same port, and start up SEND instruction.
- Specify a communication port (serial communication port: K0) for the F469 (UNITSEL) instruction.
- F146 (RECV) instruction is executed by specifying the transfer method (word transfer / bit transfer), the number of words, unit number of a destination unit, starting address, and the starting address of PLC memory area that stores data. Also specify the bit Nos. of both sides in the case of bit transfer.

## 5.2 MEWTOCOL-COM Master Communication (RECV)

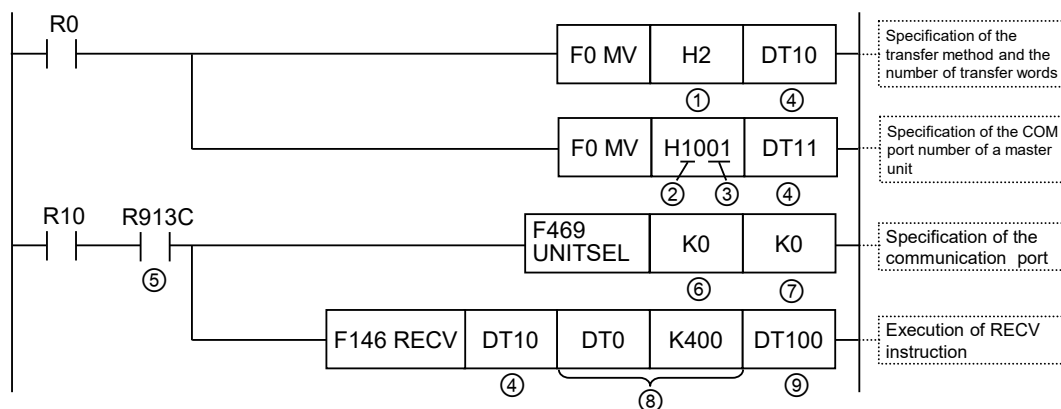

(Note 1) The slave side may not be able to respond, when the scan time of PLC as a master unit is short and interval between transmission sessions is short. In such cases, insert a timer instruction into the execution conditions for instructions, and make the sending interval longer.

Code	Description	
(1)	Transfer method and the number of transfer words	Specify the number of words in higher words of control data. Range: H1 to H1FD (1 word to 509 words)
(2)	COM port No. of a master unit	Specify a COM port No. for the higher 4 bits in lower words of control data. HF: COM0 port; H1: COM1 port; H2: COM2 port
(3)	Unit number of a destination unit	Specify a unit number of a destination unit for the lower 8 bits in lower words of control data. Range: H01 to H63 (K1 to K99)
(4)	Memory area to store control data	Specify the starting number of the area (2 words) that specifies the transfer method and the number of transfer data.
(5)	SEND/RECV instruction execution flag	This is inserted to confirm that no SEND / RECV instruction is in progress for the same port. Turns ON when an instruction is executable.
(6)	Communication port of the master unit	Specify the communication port of the master unit. To perform serial communication, specify the serial communication port (K0). K0: Serial communication port
(7)	COM port No.	When directly specifying the COM port No. using the F146 (RECV) instruction, specify K0.
(8)	Destination unit send data storage area	Using two operands, specify the type and relative address of the memory area of a destination unit that stores receive data.
(9)	Master unit memory area to store receive data	Specify the memory area of the master unit that stores receive data.

(Note 1) For details of instruction programming, refer to "8.1.3 F146 REC [MEWTOCOL Master Receiver (Serial Communication)]".

### Info.

- Other F145 (SEND) / F146 (RECV) instructions cannot be executed at the same time to a communication port during master communication. Confirm that the “SEND/RECV instruction execution flag” is ON, and execute the instructions.
- F145 (SEND) / F146 (RECV) instruction cannot be executed at the same time to a port during slave communication.
- The processing of F145 (SEND)/F146 (RECV) instructions is handled during the execution of ED instruction. Check the SEND / RECV instruction execution end flag to confirm the completion of transmission / reception. Turned ON in the case of an error, and an error code is stored in DT90123-DT90125. (Example: !61 Data error = H61)  
For details of error codes, refer to "[10.5.1 List of MEWTOCOL-COM/DAT Communication Error Codes](#)".
- In the case of COM0 port, specify “HF” as a COM port No. for an operand of the F145 (SEND) / F146 (RECV) instruction.

### ■ Special relays / special data registers

	COM0	COM1	COM2
SEND/RECV instruction execution flag	R9134	R913C (R9044)	R9144 (R904A)
SEND/RECV instruction execution end flag	R9135	R913D (R9045)	R9145 (R904B)
SEND/RECV instruction end code	DT90123	DT90124	DT90125

(Note 1) The Nos. in brackets indicate devices that are compatible with existing FP-X / FPsigma.

## 5.3 MEWTOCOL-COM Master Communication (SEND)

### 5.3 MEWTOCOL-COM Master Communication (SEND)

#### 5.3.1 For Type without Ethernet Function

##### ■ Procedure

PLC has the transmission right in master communication, and master communication is performed by sending commands to, and receiving responses from, devices that support MEWTOCOL. Data can be written by specifying unit numbers and memory addresses and executing F145 (SEND) instruction in a user program, because PLC automatically creates messages according to the protocol.

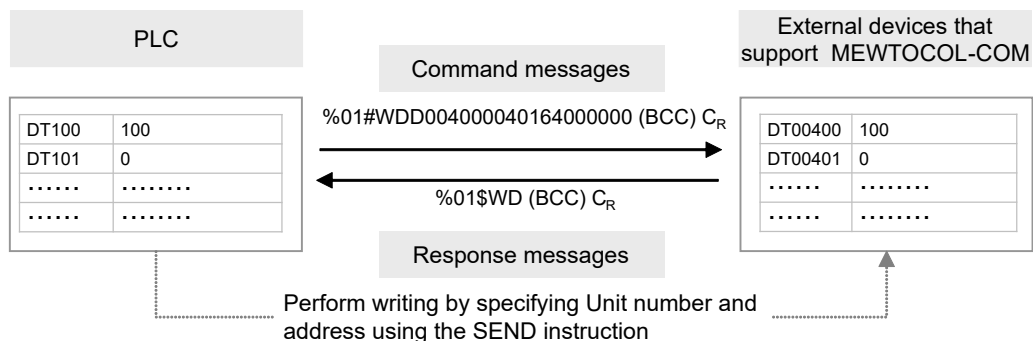

##### ■ Sample program

- Send a command from COM1 port of the unit, and write the content of the data registers DT100 to DT101 of PLC into the data areas DT400 to DT401 of an external device (unit No. 1).
- Confirm that transmission is not in progress (SEND/RECV instruction execution flag R913C: ON) for the same port, and start up SEND instruction.
- F145 (SEND) instruction is executed by specifying the transfer method (word transfer / bit transfer), the number of words, unit number of a destination unit, starting address, and the starting address of PLC memory area that stores data to be transferred. Also specify the bit Nos. of both sides in the case of bit transfer.

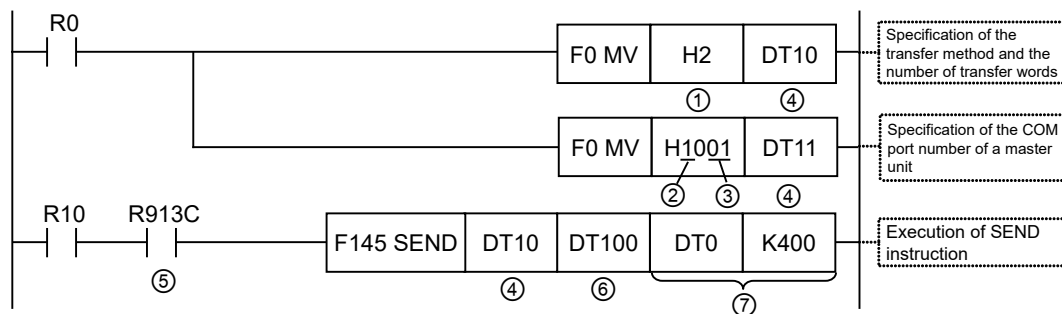

(Note 1) The slave side may not be able to respond, when the scan time of PLC as a master unit is short and interval between transmission sessions is short. In such cases, insert a timer instruction into the execution conditions for instructions, and make the sending interval longer.

## 5.3 MEWTOCOL-COM Master Communication (SEND)

Code	Description	
(1)	Number of transfer words	Specify the number of words in higher words of control data. Range: H1 to H1FB (1 word to 507 words)
(2)	COM port No. of a master unit	Specify a COM port No. for the higher 4 bits in lower words of control data. HF: COM0 port; H1: COM1 port; H2: COM2 port
(3)	Unit number of a destination unit	Specify a unit number of a destination unit for the lower 8 bits in lower words of control data. Range: H00 to H63 (K0 to K99)
(4)	Memory area to store control data	Specify the starting number of the area (2 words) that specifies the transfer method and the number of transfer data.
(5)	SEND/RECV instruction execution flag	This is inserted to confirm that no SEND / RECV instruction is in progress for the same port. Turns ON when an instruction is executable.
(6)	Memory area of a master unit that stores send data;	Specify the memory area of a master unit that stores send data.
(7)	Destination unit send data storage area	Using two operands, specify the type and relative address of the memory area of a destination unit that stores send data.

(Note 1) For details of instruction programming, refer to "8.1.2 F145 SEND [MEWTOCOL Master Send (Serial Communication)]".

### Info.

- Other F145 (SEND) / F146 (RECV) instructions cannot be executed at the same time to a communication port during master communication. Confirm that the "SEND/RECV instruction execution flag" is ON, and execute the instructions.
- F145 (SEND) / F146 (RECV) instruction cannot be executed at the same time to a port during slave communication.
- The processing of F145 (SEND) / F146 (RECV) instruction is handled during the execution of ED instruction. Check the SEND/RECV instruction execution end flag to confirm the completion of transmission / reception. Turned ON in the case of an error, and an error code is stored in DT90123-DT90125. (Example: !61 Data error = H61)

For details of error codes, refer to "10.5.1 List of MEWTOCOL-COM/DAT Communication Error Codes".

- In the case of COM0 port, specify "HF" as a COM port No. for an operand of the F145 (SEND) / F146 (RECV) instruction.

### ■ Special relays / special data registers

	COM0	COM1	COM2
SEND/RECV instruction execution flag	R9134	R913C (R9044)	R9144 (R904A)
SEND/RECV instruction execution end flag	R9135	R913D (R9045)	R9145 (R904B)
SEND/RECV instruction end code	DT90123	DT90124	DT90125

(Note 1) The Nos. in brackets indicate devices that are compatible with existing FP-X / FPsigma.

## 5.3 MEWTOCOL-COM Master Communication (SEND)

### 5.3.2 For Type with Ethernet Function

#### ■ Procedure

PLC has the transmission right in master communication, and master communication is performed by sending commands to, and receiving responses from, devices that support MEWTOCOL. Data can be written by specifying unit numbers and memory addresses and executing F145 (SEND) instruction in a user program, because PLC automatically creates messages according to the protocol.

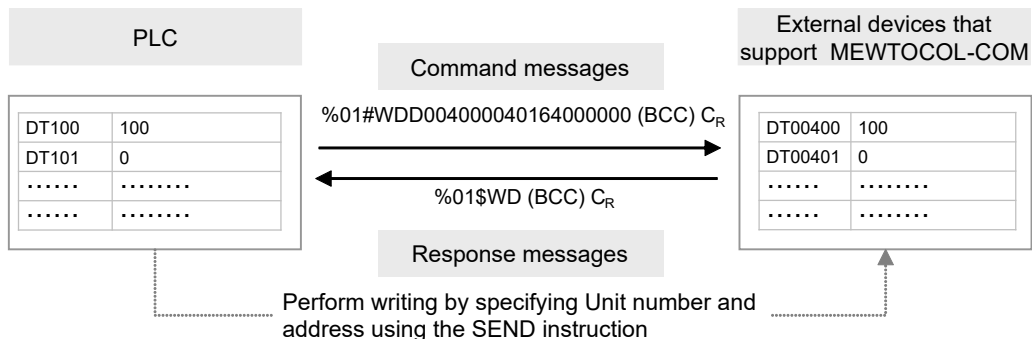

- When using both the serial communication and Ethernet communication within a program, specify the serial communication port using the F469 (UNITSEL) instruction before executing the F145 (SEND) instruction.

#### ■ Sample program

- Send a command from COM1 port of the unit, and write the content of the data registers DT100 to DT101 of PLC into the data areas DT400 to DT401 of an external device (unit No. 1).
- Confirm that transmission is not in progress (SEND/RECV instruction execution flag R913C: ON) for the same port, and start up SEND instruction.
- Specify a communication port (serial communication port: K0) for the F469 (UNITSEL) instruction.
- F145 (SEND) instruction is executed by specifying the transfer method (word transfer / bit transfer), the number of words, unit number of a destination unit, starting address, and the starting address of PLC memory area that stores data to be transferred. Also specify the bit Nos. of both sides in the case of bit transfer.

## 5.3 MEWTOCOL-COM Master Communication (SEND)

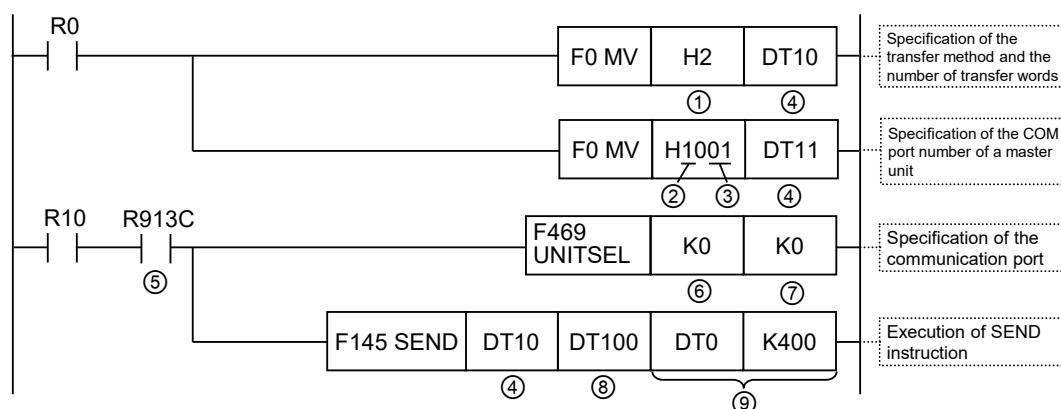

(Note 1) The slave side may not be able to respond, when the scan time of PLC as a master unit is short and interval between transmission sessions is short. In such cases, insert a timer instruction into the execution conditions for instructions, and make the sending interval longer.

Code	Description	
(1)	Number of transfer words	Specify the number of words in higher words of control data. Range: H1 to H1FB (1 word to 507 words)
(2)	COM port No. of a master unit	Specify a COM port No. for the higher 4 bits in lower words of control data. HF: COM0 port; H1: COM1 port; H2: COM2 port
(3)	Unit number of a destination unit	Specify a unit number of a destination unit for the lower 8 bits in lower words of control data. Range: H00 to H63 (K0 to K99)
(4)	Memory area to store control data	Specify the starting number of the area (2 words) that specifies the transfer method and the number of transfer data.
(5)	SEND/RECV instruction execution flag	This is inserted to confirm that no SEND / RECV instruction is in progress for the same port. Turns ON when an instruction is executable.
(6)	Communication port of the master unit	Specify the communication port of the master unit. To perform serial communication, specify the serial communication port (K0). K0: Serial communication port
(7)	COM port No.	When directly specifying the COM port No. using the F145 (SEND) instruction, specify K0.
(8)	Memory area of a master unit that stores send data;	Specify the memory area of a master unit that stores send data.
(9)	Destination unit send data storage area	Using two operands, specify the type and relative address of the memory area of a destination unit that stores send data.

(Note 1) For details of instruction programming, refer to "8.1.2 F145 SEND [MEWTOCOL Master Send (Serial Communication)]".

## 5.3 MEWTOCOL-COM Master Communication (SEND)

---

### Info.

- Other F145 (SEND) / F146 (RECV) instructions cannot be executed at the same time to a communication port during master communication. Confirm that the “SEND/RECV instruction execution flag” is ON, and execute the instructions.
- F145 (SEND) / F146 (RECV) instruction cannot be executed at the same time to a port during slave communication.
- The processing of F145 (SEND) / F146 (RECV) instruction is handled during the execution of ED instruction. Check the SEND/RECV instruction execution end flag to confirm the completion of transmission / reception. Turned ON in the case of an error, and an error code is stored in DT90123-DT90125. (Example: !61 Data error = H61)  
For details of error codes, refer to "[10.5.1 List of MEWTOCOL-COM/DAT Communication Error Codes](#)".
- In the case of COM0 port, specify “HF” as a COM port No. for an operand of the F145 (SEND) / F146 (RECV) instruction.

### ■ Special relays / special data registers

	COM0	COM1	COM2
SEND/RECV instruction execution flag	R9134	R913C (R9044)	R9144 (R904A)
SEND/RECV instruction execution end flag	R9135	R913D (R9045)	R9145 (R904B)
SEND/RECV instruction end code	DT90123	DT90124	DT90125

(Note 1) The Nos. in brackets indicate devices that are compatible with existing FP-X / FPsigma.



# 6 MODBUS RTU Master-Slave Communication

---

6.1 List of MODBUS RTU Supported Commands .....	6-2
6.1.1 List of MODBUS Function Codes .....	6-2
6.1.2 Device No. Correspondence Table .....	6-2
6.2 MODBUS RTU Master Communication (RECV) .....	6-3
6.2.1 For Type without Ethernet Function .....	6-3
6.2.2 For Type with Ethernet Function .....	6-5
6.3 MODBUS RTU Master Communication (SEND) .....	6-8
6.3.1 For Type without Ethernet Function .....	6-8
6.3.2 For Type with Ethernet Function .....	6-10

## 6.1 List of MODBUS RTU Supported Commands

### 6.1 List of MODBUS RTU Supported Commands

#### 6.1.1 List of MODBUS Function Codes

■ Supported commands (●: Available, Blank: Not available)

Code	Name (MODBUS)	Name	Remarks (Reference No.)	FP0H supported functions	
				Slave	Master
01	Read Coil state	Read Y / R coils	0X	●	●
02	Read Input state	Read X contact	1X	●	●
03	Read hold register	Read DT	4X	●	●
04	Read input register	Read WL / LD	3X	●	●
05	Force Single Coil	Write single Y / R	0X	●	●
06	Preset Single Register	Write DT1 word	4X	●	●
08	Diagnostics	Loopback Test	-	●	
15	Force Multiple Coils	Write multiple Y / R	0X	●	●
16	Preset Multiple Registers	Write DT multiple words	4X	●	●
22	Mask Write 4X Register	Write DT mask	4X	●	
23	Read / Write 4X Registers	Read / write DT	4X	●	

(Note 1) During master communication, MODBUS function codes 01, 02, 03 and 04 use F146 (RECV) instruction, while MODBUS function codes 05, 06, 15 and 16 use F145 (SEND) instruction.

#### 6.1.2 Device No. Correspondence Table

■ Correspondence table between MODBUS command reference Nos. and device Nos.

MODBUS reference Nos.		Data on BUS (hexadecimal)	PLC device No.
Coil	000001-001760	0000-06DF	Y0-Y109F
	002049-010240	0800-27FF	R0-R511F
Input	100001-101760	0000-06DF	X0-X109F
Holding register	400001-465533	0000-FFFC	DT0-DT65532
Input register	300001-301028	0000-007F	WL0-WL127
	302001-302256	07D0-08CF	LD0-LD255

(Note 1) The table above indicates correspondence between MODBUS reference Nos. for accessing PLC through MODBUS protocol from a higher device and operation device Nos. of PLC.

## 6.2 MODBUS RTU Master Communication (RECV)

### 6.2.1 For Type without Ethernet Function

#### ■ Procedure

PLC has the transmission right in master communication, and master communication is performed by sending commands to, and receiving responses from, devices that support MODBUS-RTU. Data can be read by specifying unit numbers and memory addresses and executing F146 (RECV) instruction in a user program, because PLC automatically creates messages according to the protocol.

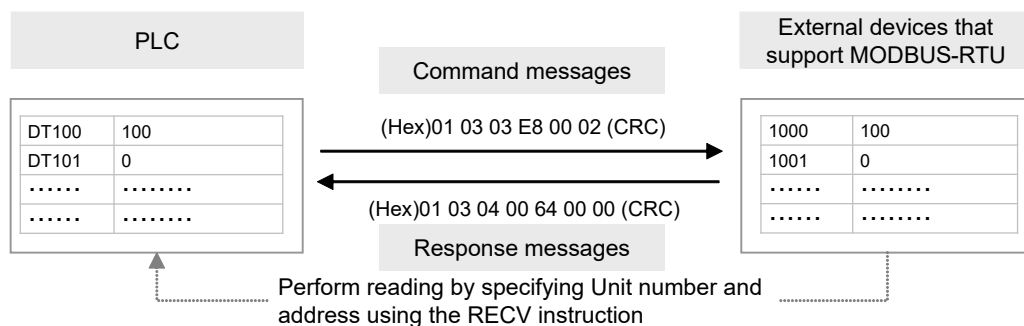

#### ■ Sample program

- Send a command from the COM1 port of the unit, read data from the data areas 1000 to 1001 (H03E8 to H03E9) of an external device (unit No. 1), and write the data into the data registers DT100 to DT101 of PLC.
- Confirm that transmission is not in progress (SEND/RECV instruction execution flag R913C: ON) for the same port, and start up RECV instruction.
- F146 (RECV) instruction is executed by specifying the port No., MODBUS command to be used, unit number of a destination unit, the number of receive data, and the starting address of PLC memory area that stores data. Check addresses of destination devices in the instruction manuals of devices.

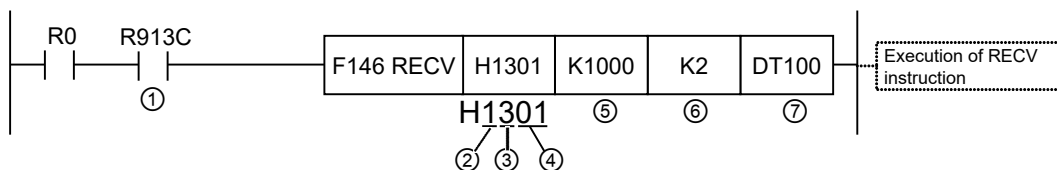

(Note 1) The slave side may not be able to respond, when the scan time of PLC as a master unit is short and interval between transmission sessions is short. In such cases, insert a timer instruction into the execution conditions for instructions, and make the sending interval longer.

Code	Description	
(1)	SEND/RECV instruction execution flag	This is inserted to confirm that no SEND / RECV instruction is in progress for the same port. Turns ON when an instruction is executable.
(2)	COM port No. of a master unit	Specify a COM port No. for Bit 15 to Bit 12 of control data. HF: COM0 port; H1: COM1 port; H2: COM2 port

## 6.2 MODBUS RTU Master Communication (RECV)

Code	Description	
(3)	MODBUS command	Specify a MODBUS command for Bit 11 to Bit 8 of control data. H1: Command 01 (Read coil state) H2: Command 02 (Read input state) H3: Command 03 (Read hold register) H4: Command 04 (Read input register)
(4)	MODBUS unit No. of a destination unit	Specify a unit number of a destination unit for Bit 7 to Bit 0 of control data. Range: H01 to HFF (K1 to K255)
(5)	MODBUS address of a destination unit	Specify the MODBUS address of the memory area of a destination unit that stores receive data.
(6)	Number of receive data	In the case of bit data, the max. number is 2040 (07F8H). In the case of word data, the max. number is 127 (7FH).
(7)	Master unit memory area to store receive data	Specify the memory area of the master unit that stores receive data.

(Note 1) For details of instruction programming, refer to "8.1.5 F146 RECV [MODBUS Master Receiver: Function Code Specification (Serial Communication)]".

### Info.

- Other F145 (SEND) / F146 (RECV) instructions cannot be executed at the same time to a communication port during master communication. Confirm that the "SEND/RECV instruction execution flag" is ON, and execute the instructions.
- F145 (SEND) / F146 (RECV) instruction cannot be executed at the same time to a port during slave communication.
- The processing of F145 (SEND) / F146 (RECV) instruction is handled during the execution of ED instruction. Check the SEND/RECV instruction execution end flag to confirm the completion of transmission / reception. Turned ON in the case of an error, and an error code is stored in DT90123-DT90125. (Example: Function code error = H1)  
For details of error codes, refer to "10.7.2 MODBUS RTU Response Format".
- In the case of COM0 port, specify "HF" as a COM port No. for an operand of the F145 (SEND) / F146 (RECV) instruction.

### ■ Special relays / special data registers

	COM0	COM1	COM2
SEND/RECV instruction execution flag	R9134	R913C (R9044)	R9144 (R904A)
SEND/RECV instruction execution end flag	R9135	R913D (R9045)	R9145 (R904B)
SEND/RECV instruction end code	DT90123	DT90124	DT90125

(Note 1) The Nos. in brackets indicate devices that are compatible with existing FP-X / FPsigma.

### 6.2.2 For Type with Ethernet Function

#### ■ Procedure

PLC has the transmission right in master communication, and master communication is performed by sending commands to, and receiving responses from, devices that support MODBUS-RTU. Data can be read by specifying unit numbers and memory addresses and executing F146 (RECV) instruction in a user program, because PLC automatically creates messages according to the protocol.

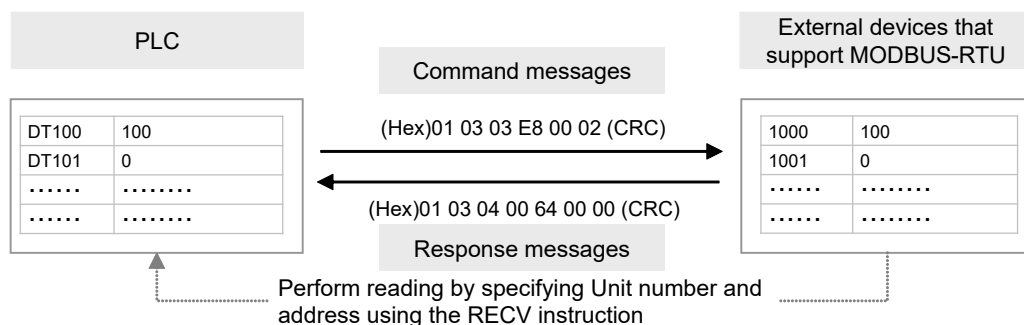

- When using both the serial communication and Ethernet communication within a program, specify the serial communication port using the F469 (UNITSEL) instruction before executing the F146 (RECV) instruction.

#### ■ Sample program

- Send a command from the COM1 port of the unit, read data from the data areas 1000 to 1001 (H03E8 to H03E9) of an external device (unit No. 1), and write the data into the data registers DT100 to DT101 of PLC.
- Confirm that transmission is not in progress (SEND/RECV instruction execution flag R913C: ON) for the same port, and start up RECV instruction.
- Specify a communication port (serial communication port: K0) for the F469 (UNITSEL) instruction.
- F146 (RECV) instruction is executed by specifying the port No., MODBUS command to be used, unit number of a destination unit, the number of receive data, and the starting address of PLC memory area that stores data. Check addresses of destination devices in the instruction manuals of devices.

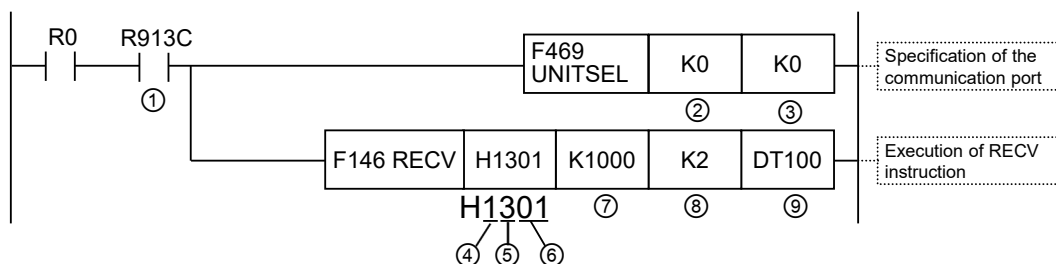

(Note 1) The slave side may not be able to respond, when the scan time of PLC as a master unit is short and interval between transmission sessions is short. In such cases, insert a timer instruction into the execution conditions for instructions, and make the sending interval longer.

## 6.2 MODBUS RTU Master Communication (RECV)

Code	Description	
(1)	SEND/RECV instruction execution flag	This is inserted to confirm that no SEND / RECV instruction is in progress for the same port. Turns ON when an instruction is executable.
(2)	Communication port of the master unit	Specify the communication port of the master unit. To perform serial communication, specify the serial communication port (K0). K0: Serial communication port
(3)	COM port No.	When directly specifying the COM port No. using the F146 (RECV) instruction, specify K0.
(4)	COM port No. of a master unit	Specify a COM port No. for Bit 15 to Bit 12 of control data. HF: COM0 port; H1: COM1 port; H2: COM2 port
(5)	MODBUS command	Specify a MODBUS command for Bit 11 to Bit 8 of control data. H1: Command 01 (Read coil state) H2: Command 02 (Read input state) H3: Command 03 (Read hold register) H4: Command 04 (Read input register)
(6)	MODBUS unit No. of a destination unit	Specify a unit number of a destination unit for Bit 7 to Bit 0 of control data. Range: H01 to HFF (K1 to K255)
(7)	MODBUS address of a destination unit	Specify the MODBUS address of the memory area of a destination unit that stores receive data.
(8)	Number of receive data	In the case of bit data, the max. number is 2040 (07F8H). In the case of word data, the max. number is 127 (7FH).
(9)	Master unit memory area to store receive data	Specify the memory area of the master unit that stores receive data.

(Note 1) For details of instruction programming, refer to "8.1.5 F146 RECV [MODBUS Master Receiver: Function Code Specification (Serial Communication)]".

### Info.

- Other F145 (SEND) / F146 (RECV) instructions cannot be executed at the same time to a communication port during master communication. Confirm that the "SEND/RECV instruction execution flag" is ON, and execute the instructions.
- F145 (SEND) / F146 (RECV) instruction cannot be executed at the same time to a port during slave communication.
- The processing of F145 (SEND) / F146 (RECV) instruction is handled during the execution of ED instruction. Check the SEND/RECV instruction execution end flag to confirm the completion of transmission / reception. Turned ON in the case of an error, and an error code is stored in DT90123-DT90125. (Example: Function code error = H1)  
For details of error codes, refer to "10.7.2 MODBUS RTU Response Format".
- In the case of COM0 port, specify "HF" as a COM port No. for an operand of the F145 (SEND) / F146 (RECV) instruction.

### ■ Special relays / special data registers

	COM0	COM1	COM2
SEND/RECV instruction execution flag	R9134	R913C (R9044)	R9144 (R904A)
SEND/RECV instruction execution end flag	R9135	R913D (R9045)	R9145 (R904B)
SEND/RECV instruction end code	DT90123	DT90124	DT90125

## 6.2 MODBUS RTU Master Communication (RECV)

---

(Note 1) The Nos. in brackets indicate devices that are compatible with existing FP-X / FPsigma.

## 6.3 MODBUS RTU Master Communication (SEND)

### 6.3 MODBUS RTU Master Communication (SEND)

#### 6.3.1 For Type without Ethernet Function

##### ■ Procedure

PLC has the transmission right in master communication, and master communication is performed by sending commands to, and receiving responses from, devices that support MODBUS-RTU. Data can be written by specifying unit numbers and memory addresses and executing F145 (SEND) instruction in a user program, because PLC automatically creates messages according to the protocol.

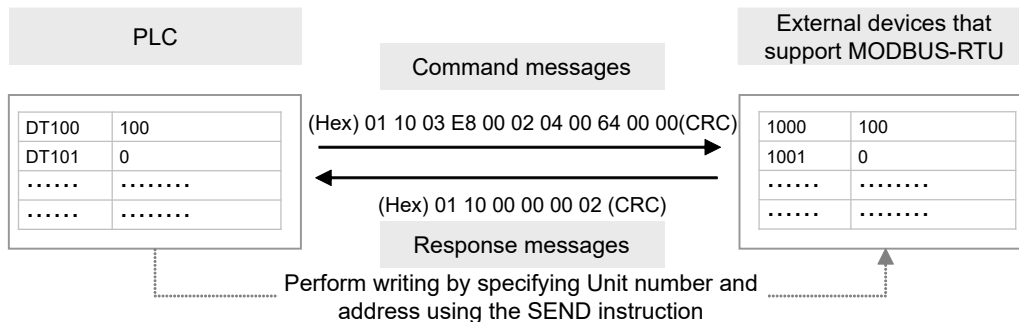

##### ■ Sample program

- Send a command from COM1 port of the unit, and write the content of the data registers DT100 to DT101 of PLC into the data areas 1000 to 1001 (H03E8 to H03E9) of an external device (unit no. 1).
- Confirm that transmission is not in progress (SEND/RCV instruction execution flag R913C: ON) for the same port, and start up SEND instruction.
- F145 (SEND) instruction is executed by specifying the port No., MODBUS command to be used, the starting address of PLC memory area that stores data to be sent, unit number of a destination unit, and the number of send data. Check addresses of destination devices in the instruction manuals of devices.

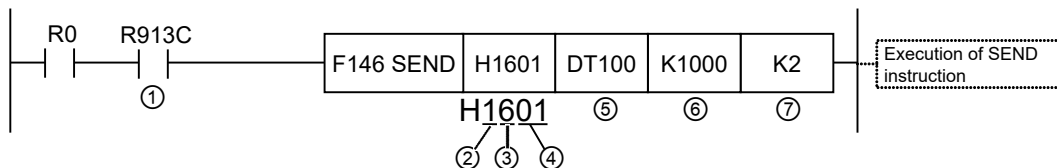

(Note 1) The slave side may not be able to respond, when the scan time of PLC as a master unit is short and interval between transmission sessions is short. In such cases, insert a timer instruction into the execution conditions for instructions, and make the sending interval longer.

Code	Description	
(1)	SEND/RCV instruction execution flag	This is inserted to confirm that no SEND / RCV instruction is in progress for the same port. Turns ON when an instruction is executable.
(2)	COM port No. of a master unit	Specify a COM port No. for Bit 15 to Bit 12 of control data. HF: COM0 port; H1: COM1 port; H2: COM2 port



## 6.3 MODBUS RTU Master Communication (SEND)

Code	Description	
(3)	MODBUS command (Note 1)	Specify a MODBUS command for Bit 11 to Bit 8 of control data. H5: Command 05 (Force a single coil) or Command 15 (Force multiple coils) H6: Command 06 (Preset a single register) or Command 16 (Preset multiple registers) HD: One-bit transfer by Command 15 HE: One-word transfer by Command 16
(4)	MODBUS unit number of a destination unit	Specify a unit number of a destination unit for Bit 7 to Bit 0 of control data. Range: H00 to HFF (K0 to K255)
(5)	Master unit memory area to store send data	Specify the memory area of a master unit that stores send data.
(6)	Destination unit send data storage area	Specify the MODBUS address of the memory area of a destination unit that stores send data.
(7)	Number of send data	In the case of bit data, the max. number is 2040 (07F8H). In the case of word data, the max. number is 127 (7FH).

(Note 1) When H5 or H6 is specified, if multiple points are specified for the number of send data, they are automatically converted into Command 15 or 16 for sending multiple bits or words.

(Note 2) For details of instruction programming, refer to "8.1.4 F145 SEND [MODBUS Master Send: Function Code Specification (Serial Communication)]".

### Info.

- Other F145 (SEND) / F146 (RECV) instructions cannot be executed at the same time to a communication port during master communication. Confirm that the "SEND/RECV instruction execution flag" is ON, and execute the instructions.
- F145 (SEND) / F146 (RECV) instruction cannot be executed at the same time to a port during slave communication.
- The processing of F145 (SEND) / F146 (RECV) instruction is handled during the execution of ED instruction. Check the SEND/RECV instruction execution end flag to confirm the completion of transmission / reception. Turned ON in the case of an error, and an error code is stored in DT90123-DT90125. (Example: Function code error = H1)  
For details of error codes, refer to "10.7.2 MODBUS RTU Response Format".
- In the case of COM0 port, specify "HF" as a COM port No. for an operand of the F145 (SEND) / F146 (RECV) instruction.

### ■ Special relays / special data registers

	COM0	COM1	COM2
SEND/RECV instruction execution flag	R9134	R913C (R9044)	R9144 (R904A)
SEND/RECV instruction execution end flag	R9135	R913D (R9045)	R9145 (R904B)
SEND/RECV instruction end code	DT90123	DT90124	DT90125

(Note 1) The Nos. in brackets indicate devices that are compatible with existing FP-X / FPsigma.

## 6.3 MODBUS RTU Master Communication (SEND)

### 6.3.2 For Type with Ethernet Function

#### ■ Procedure

PLC has the transmission right in master communication, and master communication is performed by sending commands to, and receiving responses from, devices that support MODBUS-RTU. Data can be written by specifying unit numbers and memory addresses and executing F145 (SEND) instruction in a user program, because PLC automatically creates messages according to the protocol.

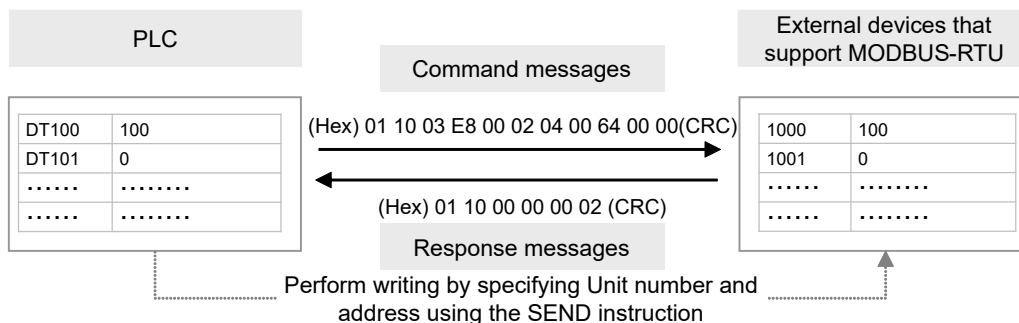

- When using both the serial communication and Ethernet communication within a program, specify the serial communication port using the F469 (UNITSEL) instruction before executing the F145 (SEND) instruction.

#### ■ Sample program

- Send a command from COM1 port of the unit, and write the content of the data registers DT100 to DT101 of PLC into the data areas 1000 to 1001 (H03E8 to H03E9) of an external device (unit no. 1).
- Confirm that transmission is not in progress (SEND/RCV instruction execution flag R913C: ON) for the same port, and start up SEND instruction.
- Specify a communication port (serial communication port: K0) for the F469 (UNITSEL) instruction.
- F145 (SEND) instruction is executed by specifying the port No., MODBUS command to be used, the starting address of PLC memory area that stores data to be sent, unit number of a destination unit, and the number of send data. Check addresses of destination devices in the instruction manuals of devices.

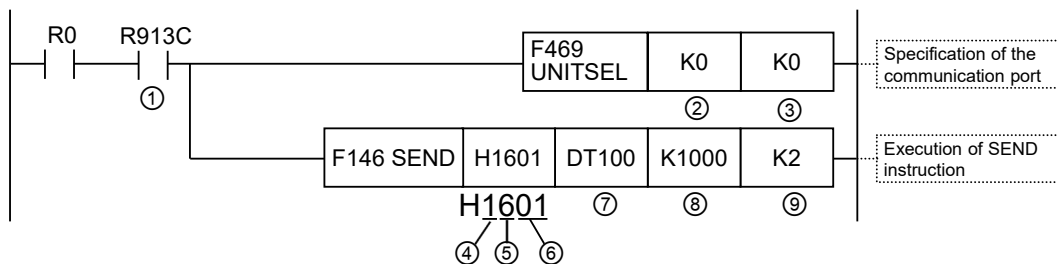

(Note 1) The slave side may not be able to respond, when the scan time of PLC as a master unit is short and interval between transmission sessions is short. In such cases, insert a timer instruction into the execution conditions for instructions, and make the sending interval longer.

## 6.3 MODBUS RTU Master Communication (SEND)

Code	Description	
(1)	SEND/RECV instruction execution flag	This is inserted to confirm that no SEND / RECV instruction is in progress for the same port. Turns ON when an instruction is executable.
(2)	Communication port of the master unit	Specify the communication port of the master unit. To perform serial communication, specify the serial communication port (K0). K0: Serial communication port
(3)	COM port No.	When directly specifying the COM port No. using the F145 (SEND) instruction, specify K0.
(4)	COM port No. of a master unit	Specify a COM port No. for Bit 15 to Bit 12 of control data. HF: COM0 port; H1: COM1 port; H2: COM2 port
(5)	MODBUS command (Note 1)	Specify a MODBUS command for Bit 11 to Bit 8 of control data. H5: Command 05 (Force a single coil) or Command 15 (Force multiple coils) H6: Command 06 (Preset a single register) or Command 16 (Preset multiple registers) HD: One-bit transfer by Command 15 HE: One-word transfer by Command 16
(6)	MODBUS unit number of a destination unit	Specify a unit number of a destination unit for Bit 7 to Bit 0 of control data. Range: H00 to HFF (K0 to K255)
(7)	Master unit memory area to store receive data	Specify the memory area of a master unit that stores send data.
(8)	Destination unit send data storage area	Specify the MODBUS address of the memory area of a destination unit that stores send data.
(9)	Number of send data	In the case of bit data, the max. number is 2040 (07F8H). In the case of word data, the max. number is 127 (7FH).

(Note 1) When H5 or H6 is specified, if multiple points are specified for the number of send data, they are automatically converted into Command 15 or 16 for sending multiple bits or words.

(Note 2) For details of instruction programming, refer to "8.1.4 F145 SEND [MODBUS Master Send: Function Code Specification (Serial Communication)]".

### Info.

- Other F145 (SEND) / F146 (RECV) instructions cannot be executed at the same time to a communication port during master communication. Confirm that the "SEND/RECV instruction execution flag" is ON, and execute the instructions.
- F145 (SEND) / F146 (RECV) instruction cannot be executed at the same time to a port during slave communication.
- The processing of F145 (SEND) / F146 (RECV) instruction is handled during the execution of ED instruction. Check the SEND/RECV instruction execution end flag to confirm the completion of transmission / reception. Turned ON in the case of an error, and an error code is stored in DT90123-DT90125. (Example: Function code error = H1)  
For details of error codes, refer to "10.7.2 MODBUS RTU Response Format".
- In the case of COM0 port, specify "HF" as a COM port No. for an operand of the F145 (SEND) / F146 (RECV) instruction.

## 6.3 MODBUS RTU Master Communication (SEND)

---

### ■ Special relays / special data registers

	COM0	COM1	COM2
SEND/RECV instruction execution flag	R9134	R913C (R9044)	R9144 (R904A)
SEND/RECV instruction execution end flag	R9135	R913D (R9045)	R9145 (R904B)
SEND/RECV instruction end code	DT90123	DT90124	DT90125

(Note 1) The Nos. in brackets indicate devices that are compatible with existing FP-X / FPsigma.

# 7 General-Purpose Communication

---

7.1 Overview of Sending Data .....	7-2
7.1.1 Overview of Sending Data (For Type without Ethernet Function) .....	7-2
7.1.2 Overview of Sending Data (For Type with Ethernet Function) ....	7-3
7.1.3 Send Data Area .....	7-5
7.2 Receiving Data from External Devices .....	7-6
7.2.1 Receiving Data from External Devices (For Type without Ethernet Function) .....	7-6
7.2.2 Receiving Data from External Devices (For Type with Ethernet Function) .....	7-7
7.2.3 Receive data area .....	7-9
7.3 Flag Operations in Transmission / Reception .....	7-10
7.3.1 When the Header is Set to “No STX” and the Terminator to “CR” ...	7-10
7.3.2 When the Header is Set to “STX” and the Terminator to “ETX” .....	7-11

## 7.1 Overview of Sending Data

### 7.1 Overview of Sending Data

#### 7.1.1 Overview of Sending Data (For Type without Ethernet Function)

Communication with external devices is handled through the data registers. When data to be sent is stored in the data register (DT) used as a send buffer, and F159 (MTRN) instruction is executed, the data is outputted from the COM port.

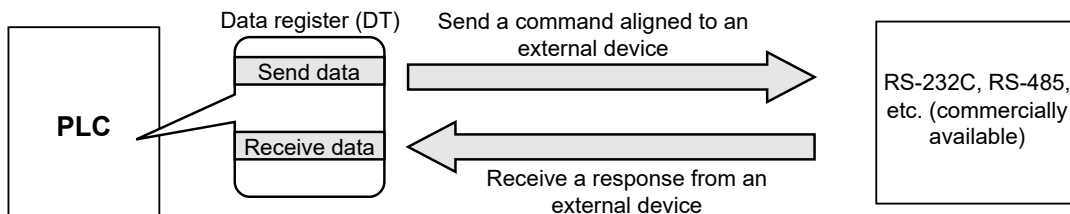

#### ■ Sample program

The following program sends a string "ABCDEFGH (Hex)" to an external device via COM1 port. The program is executed in the following sequence.

1. "ABCDEFGH" is converted to an ASCII code and stored in a data register.
2. The data of 1) above is sent from COM1 port using an F159 (MTRN) instruction.

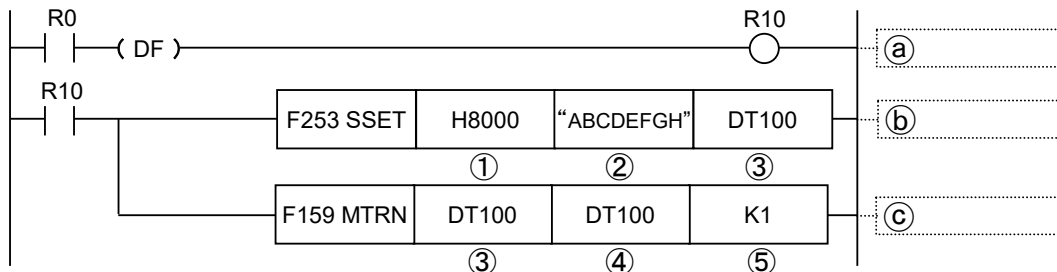

Code	Description	
(1)	Send area size	Specify "H8000". (Storage area size not specified)
(2)	Character constant to be sent	Input a character constant to be sent. In the case of input using FPWIN GR7, select "M" as a device type. On FPWIN GR7, a character constant is bracketed by double quotation marks.
(3)	Area that stores send data	Specify the starting address of the data register that stores data to be sent.
(4)	Number of send data bytes	Specify the number of send data bytes. Uses character number stored in DT100 via the F253 (SSET) instruction.
(5)	COM port No.	Specify a COM port No. for sending data. K0: COM0 port; K1: COM1 port; K2:COM2 port
(a)	Sending data instruction	Turn ON the internal relay (R10) according to the timing of send conditions (R0).
(b)	Data conversion	Convert the string "ABCDEFGH" into ASCII code. Character number is stored in DT100, and character data is stored in DT101 onward.

Code	Description	
(c)	Sending data	Data in the send buffer is sent from COM1 port.

### **i** Info.

- Do not include the terminator (end code) in the send data. The terminator is added automatically.
- When the header (start code) is set to “STX” in system register No.413 or 414, do not add the header to send data. The header is added automatically.
- When using AFP0HCCS1, transmission does not take place until CS (Clear to Send) turns ON. If you are not going to connect to the other device, connect to RS (Request to Send).
- The maximum number of bytes to be sent [n] is 2048.

### 7.1.2 Overview of Sending Data (For Type with Ethernet Function)

Communication with external devices is handled through the data registers. When data to be sent is stored in the data register (DT) used as a send buffer, and F159 (MTRN) instruction is executed, the data is outputted from the COM port.

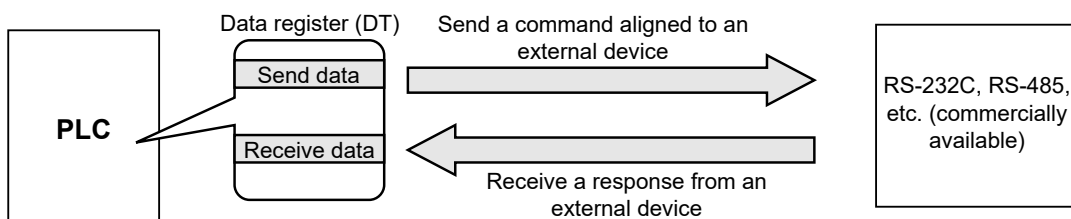

- When using both the serial communication and Ethernet communication within a program, specify the serial communication port using the F469 (UNITSEL) instruction before executing the F159 (MTRN) instruction.

#### ■ Sample program

The following program sends a string “ABCDEFGH (Hex)” to an external device via COM1 port. The program is executed in the following sequence.

1. “ABCDEFGH” is converted to an ASCII code and stored in a data register.
2. Specify K0 (serial communication port) for the F469 (UNITSEL) instruction.
3. The data of 1) above is sent from COM1 port using an F159 (MTRN) instruction.

## 7.1 Overview of Sending Data

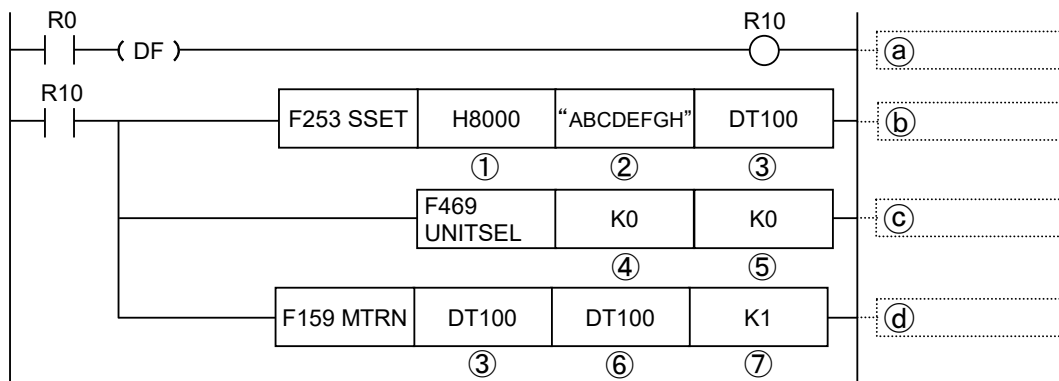

Code	Description	
(1)	Send area size	Specify "H8000". (Storage area size not specified)
(2)	Character constant to be sent	Input a character constant to be sent. In the case of input using FPCWIN GR7, select "M" as a device type. On FPCWIN GR7, a character constant is bracketed by double quotation marks.
(3)	Area that stores send data	Specify the starting address of the data register that stores data to be sent.
(4)	Communication port of the master unit	Specify the communication port of the master unit. To perform serial communication, specify the serial communication port (K0). K0: Serial communication port
(5)	COM port No.	When directly specifying the COM port No. using the F159 (MTRN) instruction, specify K0.
(6)	Number of send data bytes	Specify the number of send data bytes. Uses character number stored in DT100 via the F253 (SSET) instruction.
(7)	COM port No.	Specify a COM port No. for sending data. K0: COM0 port; K1: COM1 port; K2:COM2 port
(a)	Sending data instruction	Turn ON the internal relay (R10) according to the timing of send conditions (R0).
(b)	Data conversion	Convert the string "ABCDEFGH" into ASCII code. Character number is stored in DT100, and character data is stored in DT101 onward.
(c)	Specification of communication port	Specify the communication port of the master unit for the F469 (UNITSEL) instruction.
(d)	Sending data	Data in the send buffer is sent from COM1 port.

### **i** Info.

- Do not include the terminator (end code) in the send data. The terminator is added automatically.
- When the header (start code) is set to "STX" in system register No.413 or 414, do not add the header to send data. The header is added automatically.
- When using AFP0HCCS1, transmission does not take place until CS (Clear to Send) turns ON. If you are not going to connect to the other device, connect to RS (Request to Send).
- The maximum number of bytes to be sent [n] is 2048.



### 7.1.3 Send Data Area

Send data is stored as follows in a given memory area (e.g. data register DT). The number of send data bytes is stored in the starting word. The value is switched to “0” when transmission is complete.

#### ■ Structure of send data

Example: When an 8-byte data “ABCDEFGH” is sent

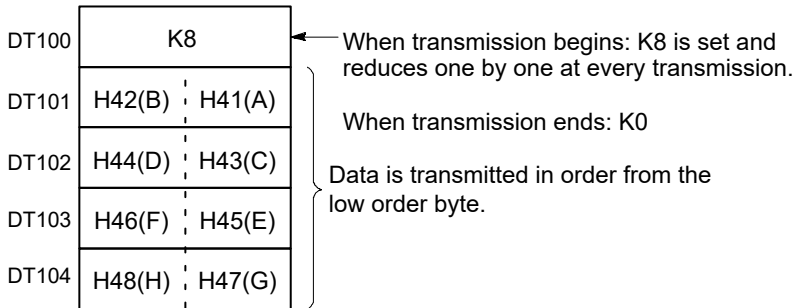

Data table before transmission

## 7.2 Receiving Data from External Devices

### 7.2 Receiving Data from External Devices

#### 7.2.1 Receiving Data from External Devices (For Type without Ethernet Function)

Data received from a COM port is stored in a “receive buffer” specified by the system register, and the “reception done” flag turns ON. If the “reception done” flag is OFF, data can be received at any time.

##### ■ Sample program

8-byte data received in the receive buffer via COM1 port is read into DT0 to DT3.

The program is executed in the following sequence.

1. The data sent from external devices is stored in the receive buffer.
2. The “reception done R913A” contact turns ON.
3. The received data is sent from the receive buffer to the area starting with data register DT0.
4. The F159 (MTRN) instruction is executed with no data, in order to reset the receive buffer writing points and to turn OFF the “reception done” contact R913A. The system is now prepared to receive the next data. (The data in the receive buffer is not cleared.)

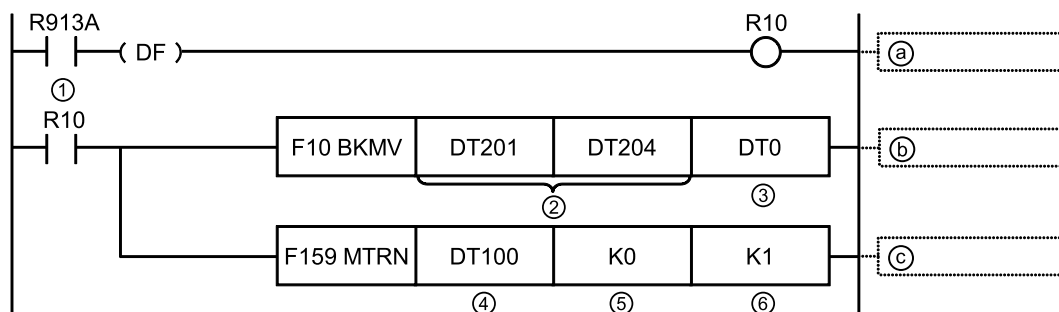

Code	Description	
(1)	Reception done flag	R9132: COM0 port; R913A: COM1 port; R9142: COM2 port
(2)	Data area of receive buffer	Specify the area of data stored in a receive buffer. In this example, 5-word area (DT201 to DT204) is specified to receive 10-byte data.
(3)	Area that transfers receive data	Receive data is transferred to a given area from the receive buffer.
(4)	Given area	To execute F159 (MTRN) instruction, specify a dummy area.
(5)	Number of send data bytes	Specify “0” for reception.
(6)	COM port No.	Specify a COM port No. for data reception. K0: COM0 port; K1: COM1 port; K2: COM2 port
(a)	Detection of reception done	Turn ON the internal relay (R10) according to the timing of reception done flag ON.
(b)	Retrieval of receive data	Transfer data from an area of receive buffer that stores receive data (DT201 to DT204) to a given data register (DT100 to DT104).
(c)	Preparation for receiving the next data	Turn OFF the reception done flag, and prepare for receiving the next data. The data in the receive buffer is not cleared.

### ■ Special relays

	COM0	COM1	COM2
Reception done flag during general-purpose communication	R9132 (R903E)	R913A (R9038)	R9142 (R9048)
Transmission done flag during general-purpose communication	R9133 (R903F)	R913B (R9039)	R9143 (R9049)

(Note 1) The Nos. in brackets indicate devices that are compatible with existing FP-X / FPsigma.

#### Info.

- Note that the reception done flag (R913A) changes even while a scan is in progress. (e.g., if the reception done flag is used multiple times as an input condition, there is a possibility of different statuses existing within the same scan.) As a protective measure, replace it with an internal relay at the beginning of the program.

### 7.2.2 Receiving Data from External Devices (For Type with Ethernet Function)

Data received from a COM port is stored in a “receive buffer” specified by the system register, and the “reception done” flag turns ON. If the “reception done” flag is OFF, data can be received at any time.



- When using both the serial communication and Ethernet communication within a program, specify the serial communication port using the F469 (UNITSEL) instruction before executing the F159 (MTRN) instruction.

### ■ Sample program

8-byte data received in the receive buffer via COM1 port is read into DT0 to DT3.

The program is executed in the following sequence.

1. The data sent from external devices is stored in the receive buffer.
2. The “reception done R913A” contact turns ON.
3. The received data is sent from the receive buffer to the area starting with data register DT0.
4. Specify K0 (serial communication port) for the F469 (UNITSEL) instruction.
5. The F159 (MTRN) instruction is executed with no data, in order to reset the receive buffer writing points and to turn OFF the “reception done” contact R913A. The system is now prepared to receive the next data. (The data in the receive buffer is not cleared.)

## 7.2 Receiving Data from External Devices

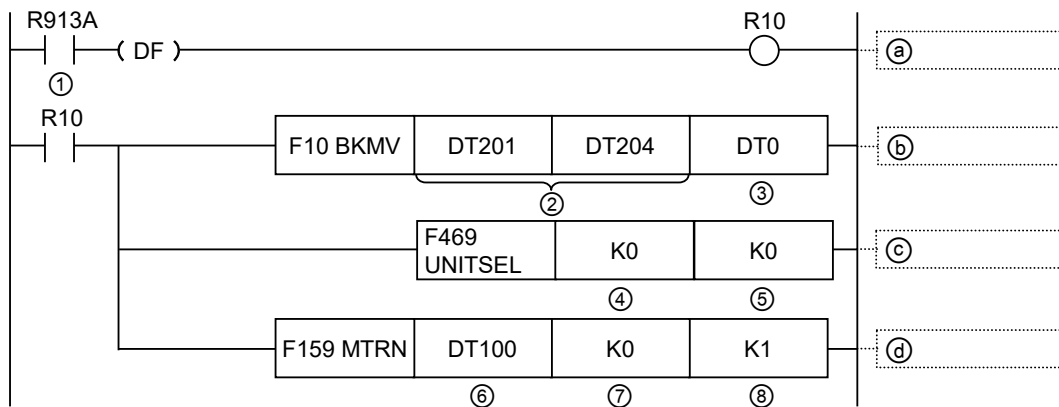

Code	Description	
(1)	Reception done flag	R9132: COM0 port; R913A: COM1 port; R9142: COM2 port
(2)	Data area of receive buffer	Specify the area of data stored in a receive buffer. In this example, 5-word area (DT201 to DT204 to DT204) is specified to receive 10-byte data.
(3)	Area that transfers receive data	Receive data is transferred to a given area from the receive buffer.
(4)	Communication port of the master unit	Specify the communication port of the master unit. To perform serial communication, specify the serial communication port (K0). K0: Serial communication port
(5)	COM port No.	When directly specifying the COM port No. using the F159 (MTRN) instruction, specify K0.
(6)	Given area	To execute F159 (MTRN) instruction, specify a dummy area.
(7)	Number of send data bytes	Specify "0" for reception.
(8)	COM port No.	Specify a COM port No. for data reception. K0: COM0 port; K1: COM1 port; K2: COM2 port
(a)	Detection of reception done	Turn ON the internal relay (R10) according to the timing of reception done flag ON.
(b)	Retrieval of receive data	Transfer data from an area of receive buffer that stores receive data (DT201 to DT204) to a given data register (DT100 to DT104).
(c)	Specification of communication port	Specify the communication port of the master unit for the F469 (UNITSEL) instruction.
(d)	Preparation for receiving the next data	Turn OFF the reception done flag, and prepare for receiving the next data. The data in the receive buffer is not cleared.

### ■ Special relays

	COM0	COM1	COM2
Reception done flag during general-purpose communication	R9132 (R903E)	R913A (R9038)	R9142 (R9048)
Transmission done flag during general-purpose communication	R9133 (R903F)	R913B (R9039)	R9143 (R9049)

(Note 1) The Nos. in brackets indicate devices that are compatible with existing FP-X / FPsigma.

**i Info.**

- Note that the reception done flag (R913A) changes even while a scan is in progress. (e.g., if the reception done flag is used multiple times as an input condition, there is a possibility of different statuses existing within the same scan.) As a protective measure, replace it with an internal relay at the beginning of the program.

**7.2.3 Receive data area**

Receive data is stored in the receive buffer (data register DT) specified in the system register. The number of receive data bytes is stored in the starting word.

**■ Structure of receive data**

Example: When 8-byte data "ABCDEFGH" is received

Specify 200 for the receive buffer starting number, and 5 for the receive buffer capacity.

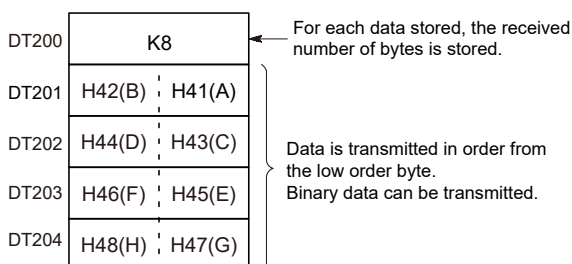

Receive buffer at the time of reception complete

**■ Receive buffer setting**

Specify the receive buffer area (data register DT) for general-purpose communication using the following system register.

Port		COM0	COM1	COM2
Starting address for data received of serial data communication mode	System register No.	No.420	No.416	No.418
	Default	4096	0	2048
Buffer capacity setting for data received of serial data communication mode	System register No.	No.421	No.417	No.419
	Default	2048	2048	2048

## 7.3 Flag Operations in Transmission / Reception

### 7.3 Flag Operations in Transmission / Reception

#### 7.3.1 When the Header is Set to “No STX” and the Terminator to “CR”

- When receiving data: The reception done flag, the transmission done flag, and the F159 (MTRN) instruction are related as follows:

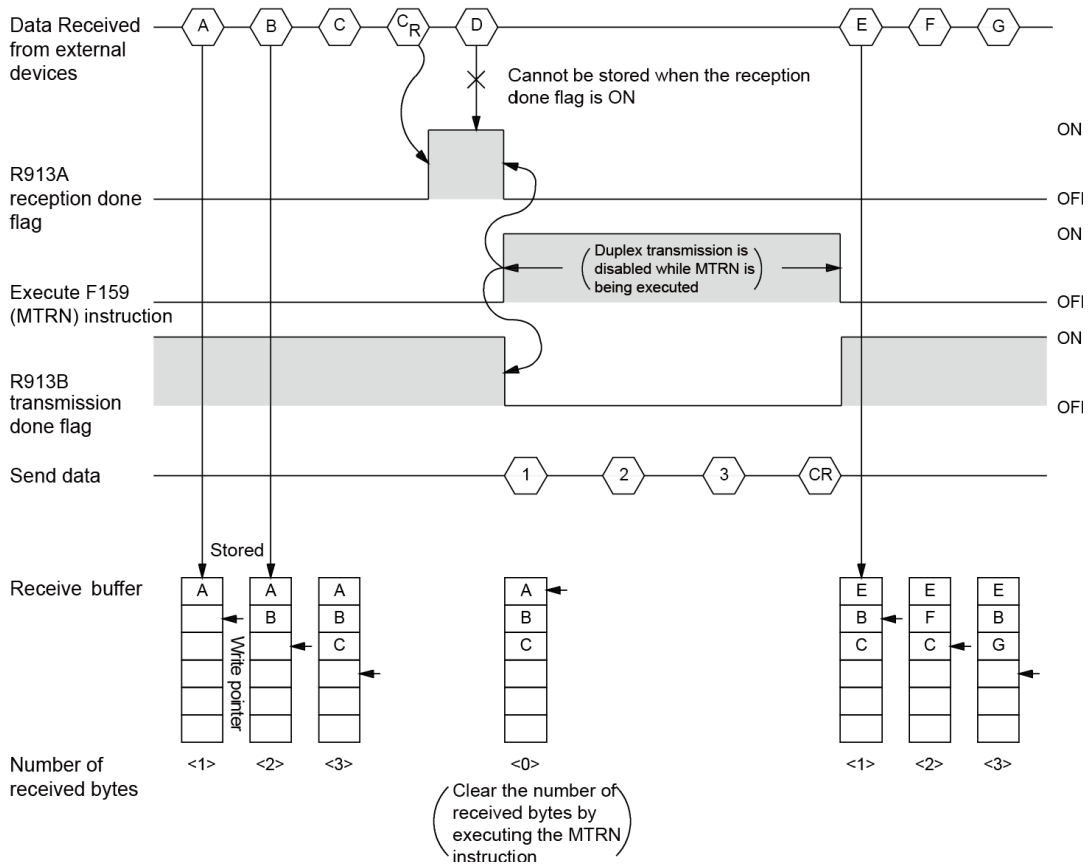

- For general-purpose communication, half-duplex transmission must be used.
- Reception is disabled when the reception done flag R913A is ON.
- When F159 (MTRN) is executed, the number of receive bytes is cleared, and the address (write pointer) in the receive buffer is reset to the starting address.
- When F159 (MTRN) is executed, the error flag R9138, the reception done flag R913A, and the transmission done flag R913B turn OFF.
- Duplex transmission is disabled while F159 (MTRN) instruction is being executed. The transmission done flag R913B must be observed.
- Reception continues even if the error flag R9138 turns ON. To resume reception, execute the F159 (MTRN) instruction to turn OFF the error flag.

### ■ Special relays / special data registers

	COM0	COM1	COM2
Reception done flag during general-purpose communication	R9132 (R903E)	R913A (R9038)	R9142 (R9048)
Transmission done flag during general-purpose communication	R9133 (R903F)	R913B (R9039)	R9143 (R9049)

(Note 1) The Nos. in brackets indicate devices that are compatible with existing FP-X / FPsigma.

### **i** Info.

- Note that the reception done flag R913A changes even while a scan is in progress. (e.g., if the “reception done” flag is used multiple times as an input condition, there is a possibility of different statuses existing within the same scan.) As a protective measure, replace it with an internal relay at the beginning of the program.

### 7.3.2 When the Header is Set to “STX” and the Terminator to “ETX”

#### ■ When receiving data: The reception done flag, the transmission done flag, and the F159 (MTRN) instruction are related as follows:

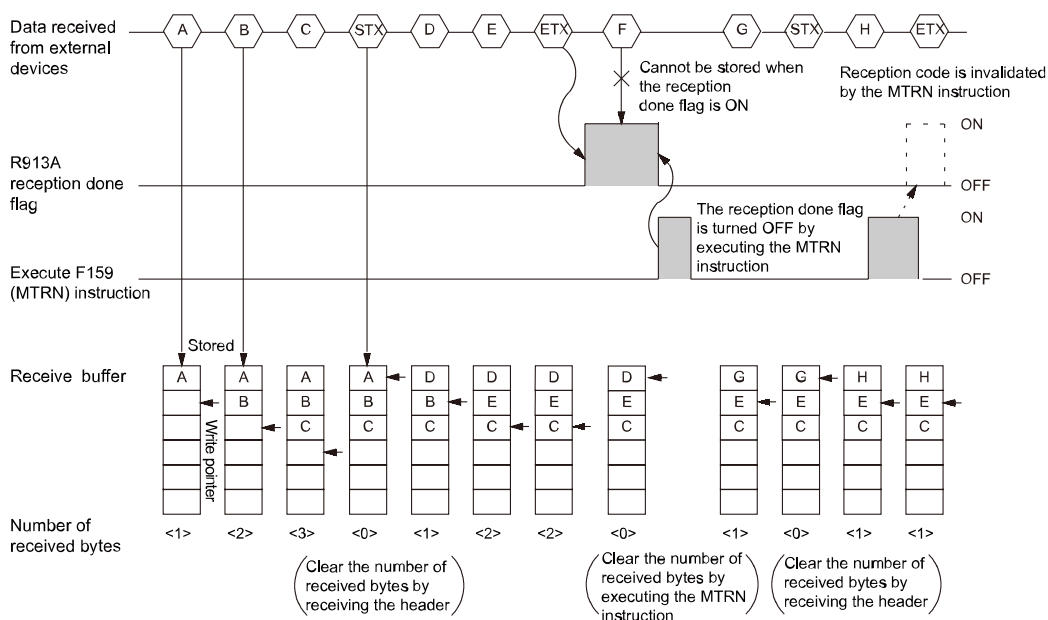

- The data is stored in the receive buffer in sequential order. When the header is received, the number of bytes received is cleared, and the address (write pointer) in the receive buffer is reset to the initial address.
- Reception is disabled when the reception done flag R913A is ON.
- When F159 (MTRN) is executed, the number of receive bytes is cleared, and the address (write pointer) in the receive buffer is reset to the starting address.

## 7.3 Flag Operations in Transmission / Reception

- If there are two headers, data following the second header is overwritten and the data is stored in the receive buffer.
- The reception done flag R913A is turned OFF by the F159 (MTRN) instruction. Therefore, if F159 (MTRN) is executed at the same time as the reception of the terminator, the reception done flag will not be detected.

■ **When sending data: The reception done flag, the transmission done flag, and the F159 (MTRN) instruction are related as follows:**

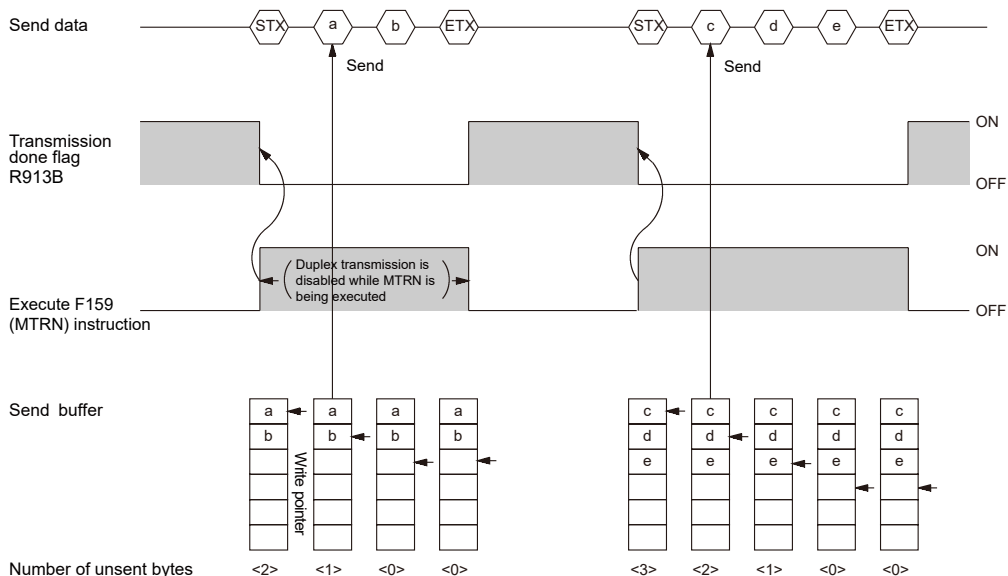

- Header (STX) and terminator (ETX) are automatically added to send data that is transmitted to an external device.
- When F159 (MTRN) is executed, the transmission done flag R913B turns OFF.
- Duplex transmission is disabled while F159 (MTRN) is being executed. The transmission done flag R913B must be observed.

■ **Special relays**

	COM0	COM1	COM2
Reception done flag during general-purpose communication	R9132 (R903E)	R913A (R9038)	R9142 (R9048)
Transmission done flag during general-purpose communication	R9133 (R903F)	R913B (R9039)	R9143 (R9049)

(Note 1) The Nos. in brackets indicate devices that are compatible with existing FP-X / FPsigma.



# 8 Instruction References

---

8.1	Serial Communication Instructions .....	8-2
8.1.1	F145 SEND / F146 RECV Instructions: Common Items (Serial Communication).....	8-2
8.1.2	F145 SEND [MEWTOCOL Master Send (Serial Communication)]..	8-3
8.1.3	F146 REC [MEWTOCOL Master Receiver (Serial Communication)].....	8-6
8.1.4	F145 SEND [MODBUS Master Send: Function Code Specification (Serial Communication)] .....	8-9
8.1.5	F146 RECV [MODBUS Master Receiver: Function Code Specification (Serial Communication)].....	8-15
8.1.6	F145 SEND [MODBUS Master Send: No Function Code Specification (Serial Communication)].....	8-19
8.1.7	F146 RECV [MODBUS Master Receiver: No Function Code Specification (Serial Communication)].....	8-25
8.1.8	F159 MTRN [General-purpose Communication Instructions (Serial Communication)].....	8-32
8.2	Character String Instructions .....	8-37
8.2.1	F253 SSET (Character Constant → ASCII Code Conversion: with Storage Area Size).....	8-37
8.3	Ethernet Instruction (Only For Type with Ethernet Function) .....	8-41
8.3.1	[F469 UNITSEL] (Communication Unit Slot Port Specification).....	8-41
8.4	Special Instruction.....	8-43
8.4.1	SYS1 (Communication Condition Setting) .....	8-43

## 8.1 Serial Communication Instructions

### 8.1 Serial Communication Instructions

#### 8.1.1 F145 SEND / F146 RECV Instructions: Common Items (Serial Communication)

##### ■ System register settings

Use tool software to set the communication mode of the COM port used.

Mode	System register No. 412
MEWTOCOL master	Computer link
MODBUS master	MODBUS RTU

##### ■ Conditions for execution of the instruction

- Multiple SEND instructions or RECV instructions cannot be executed simultaneously to the same communication port. Set up the program so that SEND/RECV instructions are executed when the SEND/RECV execution enabled flag is ON (1).

##### Info.

- In global transfer (send implemented by specifying H00 as the unit number), the SEND/RECV execution enabled flag does not turn OFF (0). Set up the program so that after a send is completed, the next send is performed after waiting for at least the maximum scan time.

##### ■ Confirmation of execution of the instruction

- The operation processing time for the SEND/RECV instruction is only for the request to send; the actual send is performed when the ED instruction is executed. Check the SEND/RECV instruction completion flag to confirm the completion of sending.
- When the instruction terminates abnormally, the SEND / RECV done flag turns ON. Also, an error code is stored in the SEND / RECV done code. For details of error codes, refer to the following table.

Special data register	Error code	Description
DT90123 to DT90125	H0	Normal end
	H73	Timeout error occurred while waiting for a response
	Error code of each protocol	For details of error codes, refer to the error codes of each protocol. <ul style="list-style-type: none"> <li>"10.5.1 List of MEWTOCOL-COM/DAT Communication Error Codes"</li> <li>"10.5.2 List of MODBUS Communication Error Codes"</li> </ul>

Name	Operation	COM0	COM1	COM2
SEND/RECV Execution enabled flag	0: Execution disabled 1: Execution enabled	R9134	R913C (R9044)	R9144 (R904A)
SEND/RECV Completion flag	0: Normal end 1: Abnormal end	R9135	R913D (R9045)	R9145 (R904B)

Name	Operation	COM0	COM1	COM2
SEND/RCV Done codes	In case of abnormal end, the error code is stored.	DT90123	DT90124	DT90125

(Note 1) The numbers inside the parentheses indicate the serial numbers of devices that are compatible with the existing products FP0R, FP-X, and FPsigma.

### ■ Timeout period setting

- If the error code is H73, it means that a timeout has occurred while waiting for a response.
- The timeout time can be changed from 10.0 ms to 81.9 s (in 2.5-ms units) by using system register No. 32. By default, the value is set to 10 s.

### ■ Other restrictions

These instructions cannot be executed on special internal relays (R9000 and up) or special data registers (DT90000).

### 8.1.2 F145 SEND [MEWTOCOL Master Send (Serial Communication)]

#### ■ Instruction format

**For Type without Ethernet Function**

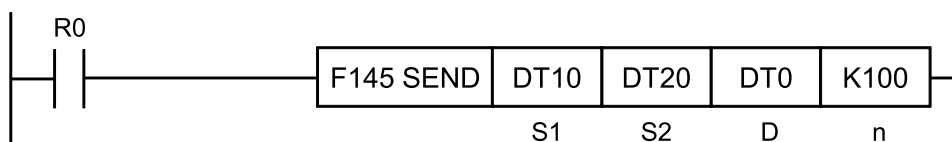

**For Type with Ethernet Function**



- When using both the serial communication and Ethernet communication within a program, specify the serial communication port using the F469 (UNITSEL) instruction before executing the F145 (SEND) instruction.

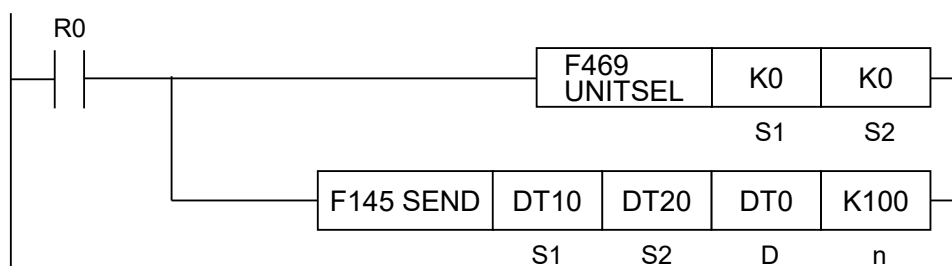

#### ■ Operands

Operands	Settings
S1	Specify the starting number of the area (2 words) that stores control data.

## 8.1 Serial Communication Instructions

Operands	Settings	
	S1	Specify the transfer method. Word transfer: Specify the number of send words. Bit transfer: Specify the bit number of a master unit and that of a destination unit.
	S1+1	Specify the COM port No. of a master unit and the unit number of a destination unit.
S2	Specification of a master unit	Specify the area of a master unit that stores send data.
D	Specification of a destination unit	Specify the area type of a destination unit that stores send data. The number is specified at 0.
n	Specification of a destination unit	Specify the starting address of a destination unit that stores send data. (Specification range: H0 to HFFFF)

### ■ Devices that can be specified (indicated by ●)

Operands	WX	WY	WR	WL	SV	EV	DT	LD	In	SW R	SDT	Constant		Index modifier (Note 1)
												K	H	
S1	●	●	●	●	●	●	●	●		●	●			●
S2	●	●	●	●	●	●	●	●		●	●			●
D		●	●	●	●	●	●	●						
n		●	●	●	●	●	●	●				●	●	●

(Note 1) A character constant cannot be specified.

### ■ Control data specification

#### Specification of [S1]

For [S1], specify the transfer method. The specification method differs depending on word transfer and bit transfer.

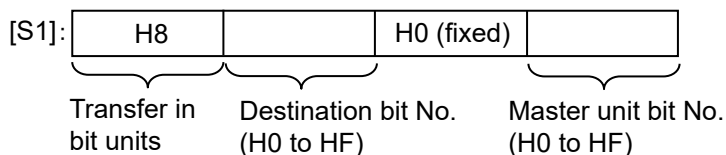
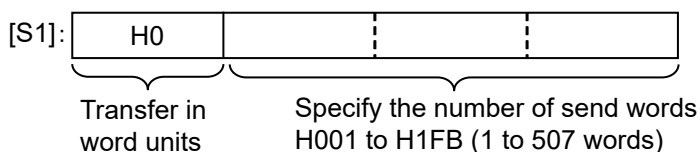

#### Specification of [S1+1]

For [S1+1], specify the COM port number of a master unit and the unit number of a destination unit.



## 8.1 Serial Communication Instructions

### ■ Flag operations

Name	Description
R9007 R9008 (ER)	Turns ON when the [S1] / [S1+1] control data value is outside the specified range.
	Turns ON when the [S2] or [D] area is exceeded, if the number of words specified in [S1] is taken during transfer in word units.
	Turns ON when [D]+[n] exceeds the [D] area
	Turns ON when the operation mode of the target COM port is other than computer link.
	Word unit <ul style="list-style-type: none"> <li>• If [D] is DT / LD, turns ON when [n] is not from 0 to 99999</li> <li>• If [D] is WY / WR / WL / SV / EV, turns ON when [n] is not from 0 to 9999.</li> </ul>
	Bit unit <ul style="list-style-type: none"> <li>• Turns ON when [D] is not WY / WR / WL</li> <li>• Turns ON when [n] is not from 0 to 999.</li> </ul>
	Turns ON when the [D] device No. is not 0.
Turns ON when a communication cassette is not attached to the target COM port.	

### 8.1.3 F146 REC [MEWTOCOL Master Receiver (Serial Communication)]

#### ■ Instruction format

##### For Type without Ethernet Function

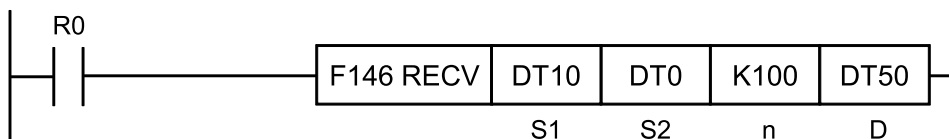

##### For Type with Ethernet Function



- When using both the serial communication and Ethernet communication within a program, specify the serial communication port using the F469 (UNITSEL) instruction before executing the F146 (RECV) instruction.

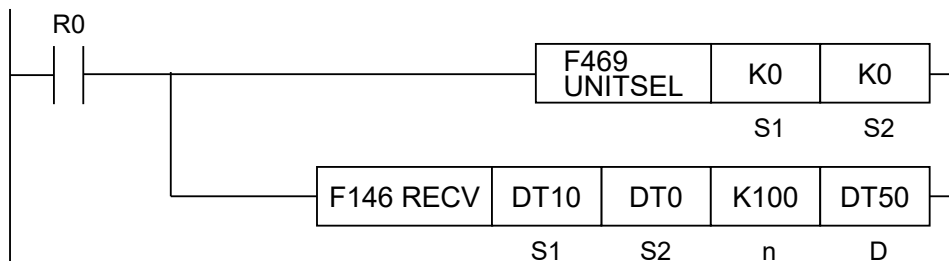

### ■ Operands

Operands	Settings	
S1	Specify the starting number of the area (2 words) that stores control data.	
	S1	Specify the transfer method. Word transfer: Specify the number of send words. Bit transfer: Specify the bit number of a master unit and that of a destination unit.
	S1+1	Specify the COM port No. of a master unit and the unit number of a destination unit.
S2	Specification of a destination unit	Specify the source data area of a destination unit. (Device No. is fixed to "0")
n	Specification of a destination unit	Specify the starting address of the device in the source data area of a destination unit. (Setting range: H0 to HFFFF)
D	Specification of a master unit	Specify the device starting address of the receive data storage area in the master unit.

### ■ Devices that can be specified (indicated by ●)

Operands	WX	WY	WR	WL	SV	EV	DT	LD	In	SW R	SDT	Constant		Index modifier (Note 1)
												K	H	
S1	●	●	●	●	●	●	●	●		●	●			●
S2	●	●	●	●	●	●	●	●						
n		●	●	●	●	●	●	●				●	●	●
D		●	●	●	●	●	●	●						●

(Note 1) A character constant cannot be specified.

### ■ Specifying control data [S1], [S1+1]

#### Specification of [S1]

For [S1], specify the transfer method. The specification method differs depending on word transfer and bit transfer.

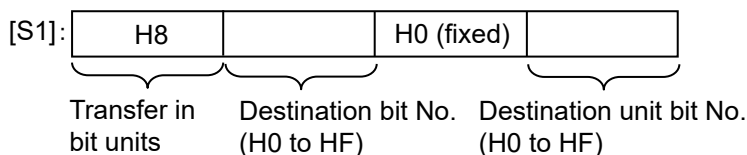
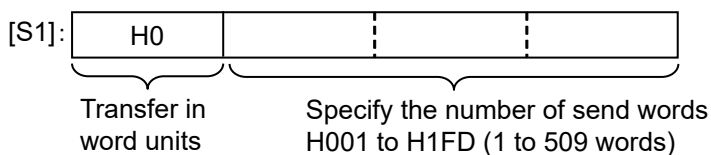

#### Specification of [S1+1]

For [S1+1], specify the COM port number of a master unit and the unit number of a destination unit.

## 8.1 Serial Communication Instructions

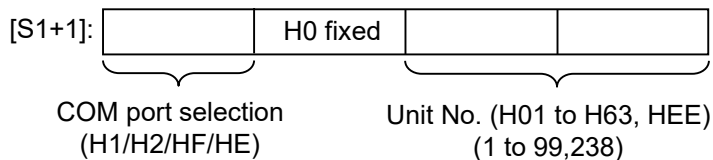

### COM port selection

COM ports can be selected as shown in the following table.

COM port selection (upper four bits)	H1	H2	HF	HE
Port number	COM1	COM2	COM0	Port number specified for the F469 (UNITSEL) instruction

### Destination unit number selection

On unit firmware Ver. 1.8 or later, adding a specification of HEE (238) for the destination unit number allows for communication to be carried out regardless of destination unit number.

#### ■ Specifying [S2] as the starting address of the source data area

Specify "0" for [S2] as the device number. Specify the memory area of a destination unit that stores sent data, by combining [S2] (type) and [n] (address).

Example 1: [S2]: DT0, [n]: K100

↓  
DT100

Example 2: [S2]: DT0, [n]: HFFF0

↓  
DT65520

#### ■ Specifying a COM port number for the F469 (UNITSEL) instruction (only for the type with Ethernet Function)

Specifying HE in the upper four bits of [S1+1] of the F146 (RECV) enables operand [S2] for the F469 (UNITSEL) instruction. The following figure shows that the F469 (UNITSEL) instruction specifies S1=K0 (serial communication port) and S2=K1 (COM1).

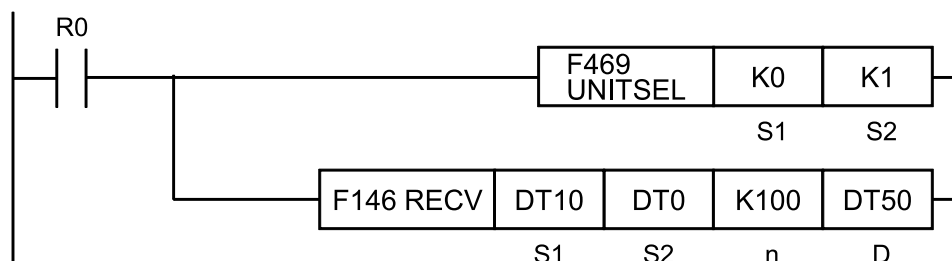

[S2] of F469 (UNITSEL)	K0	K1	K2
Port number	COM0	COM1	COM2



### ■ Flag operations

Name	Description
R9007 R9008 (ER)	Turns ON when the [S1] / [S1+1] control data value is outside the specified range.
	Turns ON when the [S2] or [D] area is exceeded, if the number of words specified in [S1] is taken during transfer in word units.
	Turns ON when [S2]+[n] exceeds the [S2] area.
	Turns ON when the operation mode of the target COM port is other than computer link.
	Word unit <ul style="list-style-type: none"> <li>• If [S2] is DT / LD, turns ON when [n] is not from 0 to 99999.</li> <li>• If [S2] is WX / WY / WR / WL / SV / EV, turns ON when [n] is not from 0 to 9999.</li> </ul>
	Bit unit <ul style="list-style-type: none"> <li>• Turns ON when [S2] is not WX / WY / WR / WL.</li> <li>• Turns ON when [n] is not from 0 to 999.</li> </ul>
	Turns ON when the [S2] device No. is not 0.
Turns ON when a communication cassette is not attached to the target COM port.	

### 8.1.4 F145 SEND [MODBUS Master Send: Function Code Specification (Serial Communication)]

#### ■ Instruction format

##### For Type without Ethernet Function

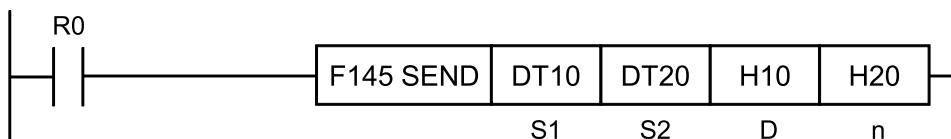

##### For Type with Ethernet Function



- When using both the serial communication and Ethernet communication within a program, specify the serial communication port using the F469 (UNITSEL) instruction before executing the F145 (SEND) instruction.

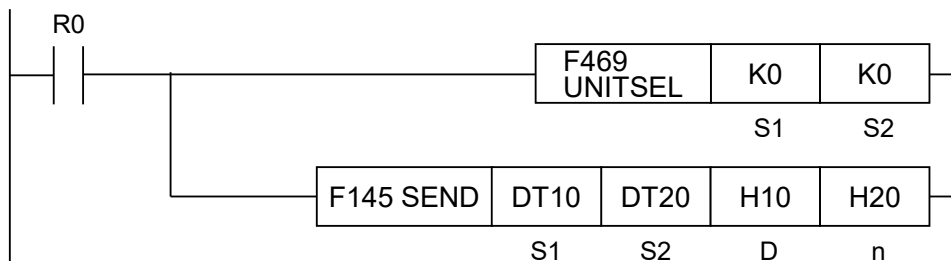

## 8.1 Serial Communication Instructions

### ■ Operands

Items	Settings	
S1	Specify the COM port No. of a master unit, send MODBUS command, and the unit number of a destination unit.	
S2	Specification of a master unit	Operation memory area that stores data to be sent.
D	Specification of a destination unit	MODBUS address specification (specification range: H0 to HFFFF)
n	Specification of a destination unit	Specify the number of sent data. Specification range: 1 to 127 words (word specification), 1 to 2040 bits (bit specification)

### ■ Devices that can be specified (indicated by ●)

Operands	WX	WY	WR	WL	SV	EV	DT	LD	In	SW R	SDT	Constant		Index modifier (Note 1)
												K	H	
S1	●	●	●	●	●	●	●	●		●	●	●	●	●
S2	●	●	●	●	●	●	●	●		●	●			●
D		●	●	●	●	●	●	●				●	●	
n		●	●	●	●	●	●	●				●	●	●

(Note 1) A character constant cannot be specified.

### ■ Specification of [S1]

In [S1], specify the combination of the COM port No. of a master unit, MODBUS function code and the unit number of a destination unit. When the COM port No. is 0, specify HF for the highest digit.

Example: In the case of COM port 1, MODBUS function code 6, and destination unit No. 10, specify H160A.

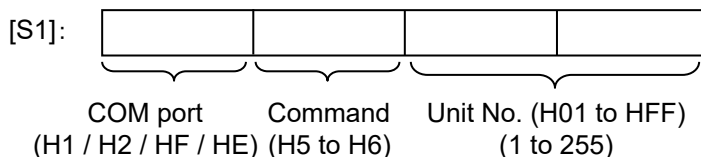

COM port selection (upper four bits)	H1	H2	HF	HE
Port number	COM1	COM2	COM0	Port number specified for the F469 (UNITSEL) instruction

### ■ Specification of [S2], [n]

Depending on the operation memory type specified in operand [S2] and the number of send data specified in operand [n], the transfer method and the function code of MODBUS command to be sent vary.

## 8.1 Serial Communication Instructions

For the number of send data [n], specify the number of words in the case of register transfer, and specify the number of bits in the case of bit transfer.

Type of device specified in [S2]	Transfer method	Number of send data [n]	MODBUS command to be sent
16-Bit device: WX, WY, WR, WL, DT, LD	Register transmission	1	Preset single register (06)
		2 to 127	HF: Force multiple coils (15) H10: Preset multiple registers (16)
1-Bit device: X, Y, R, L	Bit transmission	1	H5: Force single coil (05)
		2 to 2040	HF: Force multiple coils (15):

### ■ Specification of a destination unit [D]

When "0" is specified for the destination unit number, global transfer is applied.

In this process, there is no response message from a destination unit.

### ■ Specifying a COM port number for the F469 (UNITSEL) instruction (only for the type with Ethernet Function)

Specifying HE in the upper four bits of [S1] of F145 (SEND) enables operand [S2] for the F469 (UNITSEL) instruction. The following figure shows that the F469 (UNITSEL) instruction specifies S1=K0 (serial communication port) and S2=K1 (COM1).

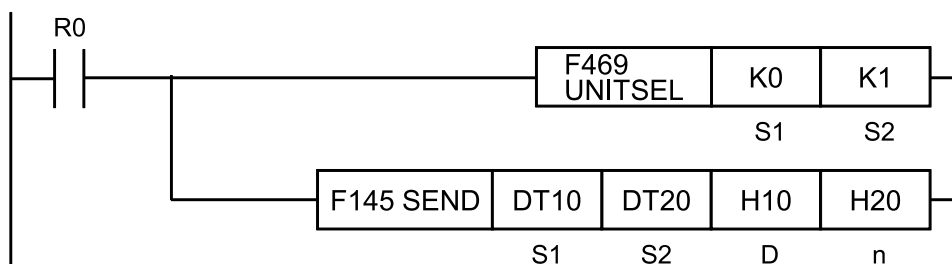

[S2] of F469 (UNITSEL)	K0	K1	K2
Port number	COM0	COM1	COM2

### ■ MODBUS command specification example

#### Command 05 (force single coil)

- Example 1) Transfer from COM1 of the value in 0th bit of WR3 to bit in bit address H7788 of unit number 7

## 8.1 Serial Communication Instructions

### [F145(SEND), H1507, WR3, H7788, K1]

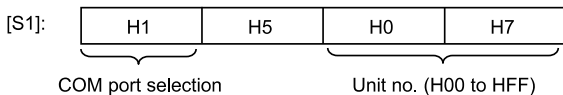

[S1]: H1507

[S2]: WR3 (WR3=0007H)

[D]: H7788

[n]: K1

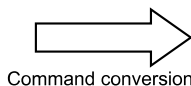

MODBUS command

1	Slave address	07
2	Command (05H)	05
3	Coil number (H)	77
4	Coil number (L)	88
5	Set state (H)	FF
6	Set state (L)	00
7	CRC16(H)	17
8	CRC16(L)	C2

(Note 1) Depending on whether WR3 0th bit is ON or OFF, sets settings status.  
Set ON=FF00, set OFF=0000

### Command 06 (preset single register)

- Example 2: Transfer from COM1 of 1 word of data in WR3 to address H7788 of unit number 7

### [F145(SEND), H1607, WR3, H7788, K1]

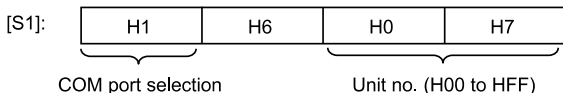

[S1]: H1607

[S2]: WR3 (WR3=1234H)

[D]: H7788

[n]: K1

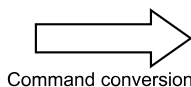

MODBUS command

1	Slave address	07
2	Command (06H)	06
3	Write start number (H)	77
4	Write start number (L)	88
5	Write data (H)	12
6	Write data (L)	34
7	CRC16(H)	53
8	CRC16(L)	C2

(Note 1) Reads WR3 word data and sets it as write data.

### Command 15 (force multiple coils)

- Example 3) Transfer from COM1 of 64 bits of data from WR3 0th bit to WR6 Fth bit to bit address H7788 of unit number 7



## 8.1 Serial Communication Instructions

### [F145(SEND), H1607, DT3, H7788, K3]

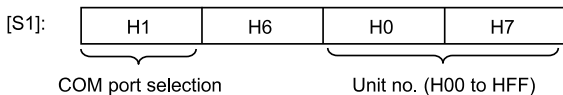

[S1]: H1607

[S2]: DT3 (DT3=0011H  
DT4=2233H  
DT5=4455H)

[D]: H7788

[n]: K3

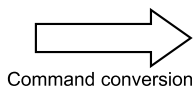

MODBUS command

1	Slave address	07
2	Command (10H)	10
3	Write start number (H)	77
4	Write start number (L)	88
5	Write register count (H)	00
6	Write register count (L)	03
7	Data count (byte count)	06
8	Write data 1 (H)	00
9	Write data 1 (L)	11
10	Write data 2 (H)	22
11	Write data 2 (L)	33
12	Write data 3 (H)	44
13	Write data 3 (L)	55
14	CRC16(H)	2C
15	CRC16(L)	BA

(Note 1) If multiple points are specified for n, the command will be corrected automatically.

(Note 2) Write resistor number maximum is 127 (7FH) (due to MODBUS protocol limits)

Data number (byte number) is calculated as 2 bytes for write resistor number. [Max 254 (FEH) bytes]

### ■ Flag operations

Name	Description
R9007 R9008 (ER)	Turns ON when the [S1] control data value is outside the specified range.
	Turns ON when the COM port specification of control data specified in [S1] is not MODBUS mode.
	Turns ON when the number of send data [n] is 0.
	Turns ON when the number of send data is negative.
	Turns ON when the number of send data [n] exceeds the operation memory area specified in [S2].
	Turns ON when the number of send data [n] exceeds limitation in MODBUS specification.

### 8.1.5 F146 RECV [MODBUS Master Receiver: Function Code Specification (Serial Communication)]

#### ■ Instruction format

##### For Type without Ethernet Function

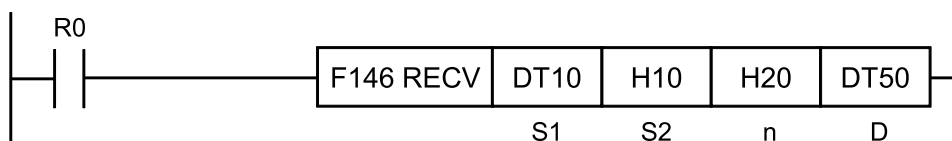

##### For Type with Ethernet Function



- When using both the serial communication and Ethernet communication within a program, specify the serial communication port using the F469 (UNITSEL) instruction before executing the F146 (RECV) instruction.

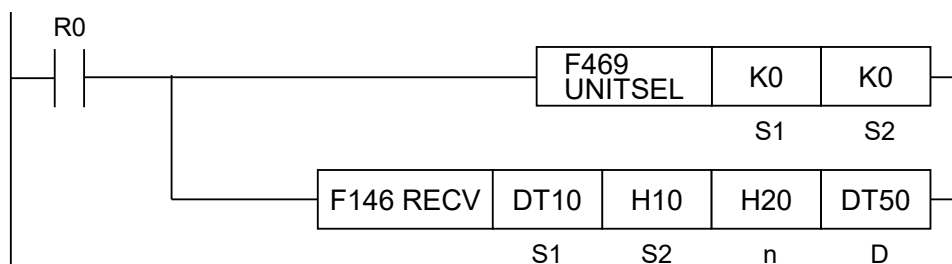

#### ■ Operands

Items	Settings	
S1	Specify the COM port No. of a master unit, transmission MODBUS command, and the unit number of a destination unit.	
S2	Specification of a destination unit	MODBUS address specification (specification range: H0 to HFFFF)
n	Specification of a destination unit	Specify the number of receive data. Resistor transfer specifies the number of words. (Specification range: 1 to 127 words) Specify bit number when transferring bits. (Specification range: 1 to 2040 bits)
D	Specification of a master unit	Operation memory area that stores receive data

#### ■ Devices that can be specified (indicated by ●)

Operands	WX	WY	WR	WL	SV	EV	DT	LD	In	SW R	SDT	Constant		Index modifier (Note 1)
												K	H	
S1	●	●	●	●	●	●	●	●		●	●	●	●	●

## 8.1 Serial Communication Instructions

Operands	WX	WY	WR	WL	SV	EV	DT	LD	In	SWR	SDT	Constant		Index modifier (Note 1)
												K	H	
S2	•	•	•	•			•	•				•	•	
n		•	•	•	•	•	•	•				•	•	•
D		•	•	•	•	•	•	•						•

(Note 1) A character constant cannot be specified.

### ■ Specification of [S1]

In [S1], specify the combination of the COM port No. of a master unit, MODBUS function code and the unit number of a destination unit. When the COM port No. is 0, specify HF for the highest digit.

Example: In the case of COM port No. 1, MODBUS function code 3, and destination unit No.10, specify H130A.

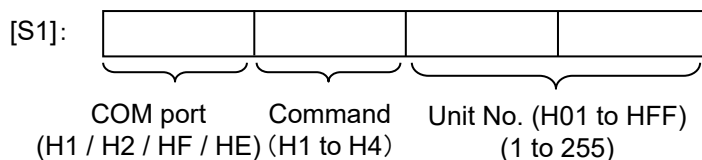

COM port selection (upper four bits)	H1	H2	HF	HE
Port number	COM1	COM2	COM0	Port number specified for the F469 (UNITSEL) instruction

### ■ Specification of [D]

Depending on the operation memory type specified in operand [D], and the number of receive data specified in operand [n], the transfer method and the function code of MODBUS command vary.

Device specified in [D]	Transfer method	MODBUS command to be sent
16-Bit device: WX, WY, WR, WL, DT, LD	Register transmission	H1: Read coil state (01) H2: Read input state (02) H3: Read hold register (03) H4: Read input register (04)
1-Bit device: X, Y, R, L	Bit transmission	H1: Read coil state (01) H2: Read input state (02)

### ■ Specifying a COM port number for the F469 (UNITSEL) instruction (only for the type with Ethernet Function)

Specifying HE in the upper four bits of [S1] of F146 (RECV) enables operand [S2] for the F469 (UNITSEL) instruction. The following figure shows that the F469 (UNITSEL) instruction specifies S1=K0 (serial communication port) and S2=K1 (COM1).



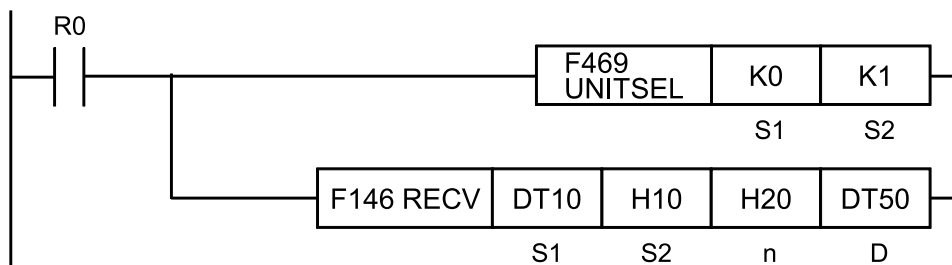

[S2] of F469 (UNITSEL)	K0	K1	K2
Port number	COM0	COM1	COM2

### ■ MODBUS command specification example

#### Command 01 (read coil state)

- Example 1) Reading 1 bit from unit number 17 bit address H7788 connected to COM1, and writing to master unit DT100 bit 0

**[F146(RECV), H1111, H7788, K1, DT100]**

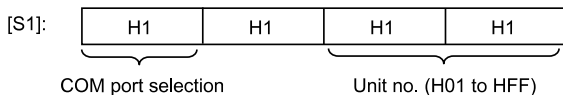

[S1]: H1111  
[S2]: H7788  
[n]: K1  
[D]: DT100

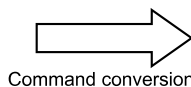

Command conversion

MODBUS command	
1	Slave address      11
2	Command (01H)      01
3	Read start number (H)   77
4	Read start number (L)   88
5	Read count (H)      00
6	Read count (L)      01
7	CRC16(H)            64
8	CRC16(L)            C4

- Example 2) Reading 64 bits (4 words) from unit number 17 bit address H7788 connected to COM1, and writing to master unit DT100 starting at bit 0

**[F146(RECV), H1111, H7788, K64, DT100]**

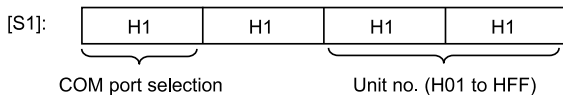

[S1]: H1111  
[S2]: H7788  
[n]: K64  
[D]: DT100

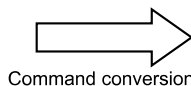

Command conversion

MODBUS command	
1	Slave address      11
2	Command (01H)      01
3	Read start number (H)   77
4	Read start number (L)   88
5	Read count (H)      00
6	Read count (L)      40
7	CRC16(H)            A4
8	CRC16(L)            F4

## 8.1 Serial Communication Instructions

### Command 02 (read input state)

- Example 3) Reading 1 bit from unit number 17 bit address H7788 connected to COM1, and writing to master unit DT100 bit 0

#### [F146(RECV), H1211, H7788, K1, DT100]

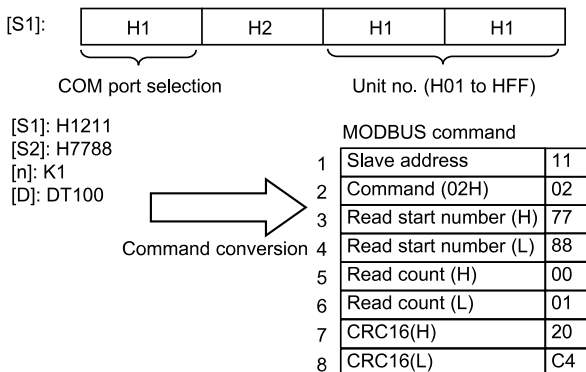

- Example 4) Reading 64 bits (4 words) from unit number 17 bit address H7788 connected to COM1, and writing to master unit DT100 starting at bit 0

#### [F146(RECV), H1211, H7788, K64, DT100]

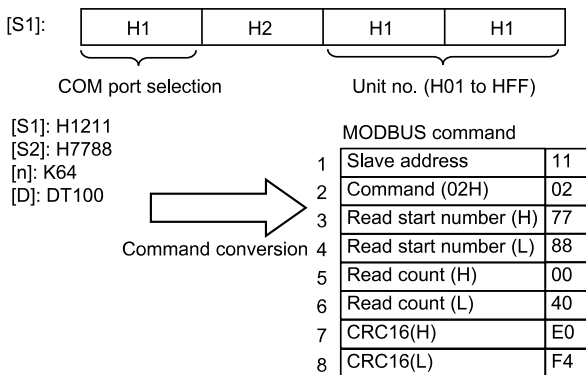

### Command 03 (read hold register)

- Example 5) Reading 6 words from unit number 17 address H7788 connected to COM1, and writing to master unit starting at DT100

#### [F146(RECV), H1311, H7788, K6, DT100]

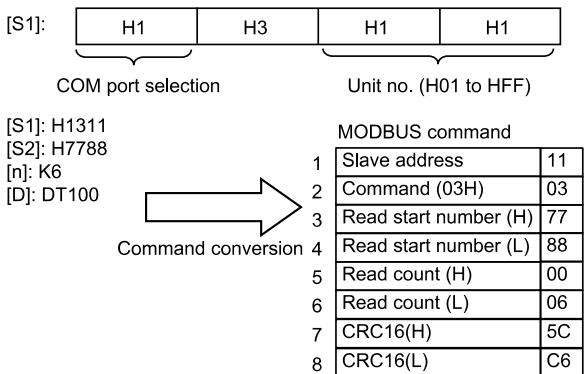

### Command 04 (read input register)

- Example 6) Reading 6 words from unit number 17 address H7788 connected to COM1, and writing to master unit starting at DT100

#### [F146(RECV), H1411, H7788, K6, DT100]

[S1]: H1411  
 [S2]: H7788  
 [n]: K6  
 [D]: DT100

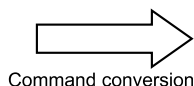

MODBUS command		
1	Slave address	11
2	Command (04H)	04
3	Read start number (H)	77
4	Read start number (L)	88
5	Read count (H)	00
6	Read count (L)	06
7	CRC16(H)	E9
8	CRC16(L)	06

### ■ Flag Operands

Name	Description
R9007 R9008 (ER)	Turns ON when the [S1] control data value is outside the specified range.
	Turns ON when the COM port specification of control data specified in [S1] is not MODBUS mode.
	Turns ON when the number of receive data [n] is 0
	Turns ON when the number of receive data is negative
	Turns ON when the number of receive data [n] exceeds MODBUS specification
	Turns ON when the operation memory area specified in [D] is exceeded if the number of receive data [n] is received.

### 8.1.6 F145 SEND [MODBUS Master Send: No Function Code Specification (Serial Communication)]

#### ■ Instruction format

##### For Type without Ethernet Function

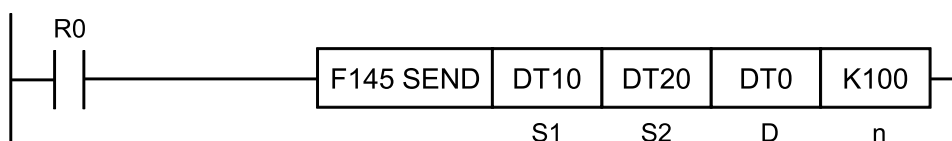

##### For Type with Ethernet Function



- When using both the serial communication and Ethernet communication within a program, specify the serial communication port using the F469 (UNITSEL) instruction before executing the F145 (SEND) instruction.

## 8.1 Serial Communication Instructions

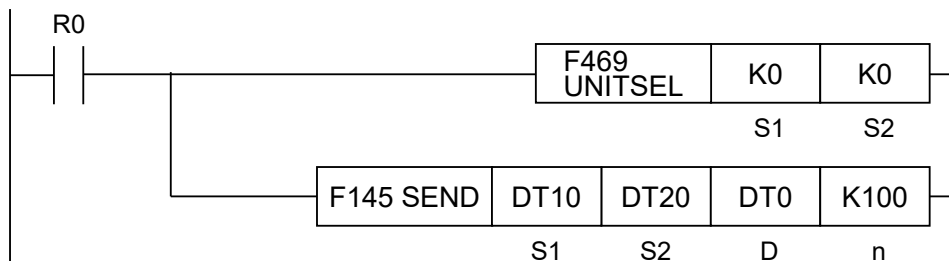

### ■ Operands

Operands	Settings	
S1	Specify the starting number of the area (2 words) that stores control data.	
	S1	Specify the transfer method. Word transfer: Specify the number of send words. Bit transfer: Specify the bit number of a master unit and that of a destination unit.
	S1+1	Specify the COM port No of a master unit and the unit number of a destination unit.
S2	Specification of a master unit	Specify the area of a master unit that stores send data.
D	Specification of a destination unit	Specify the area type of a destination unit that stores send data. The number is specified at 0.
n	Specification of a destination unit	Specify the starting address of a destination unit that stores send data.

### ■ Devices that can be specified (indicated by ●)

Operands	WX	WY	WR	WL	SV	EV	DT	LD	In	SW R	SDT	Constant		Index modifier (Note 1)
												K	H	
S1	●	●	●	●	●	●	●	●		●	●			●
S2	●	●	●	●	●	●	●	●		●	●			●
D		●	●				●							
N		●	●	●	●	●	●	●				●	●	●

(Note 1) A character constant cannot be specified.

### ■ Specifying control data [S1], [S1+1]

#### Specification of [S1]

#### Specification of [S1+1]

For [S1+1], specify the COM port number of a master unit and the unit number of a destination unit.

When "0" is specified for the destination unit number, global transfer is applied. In this process, there is no response message from a destination unit.

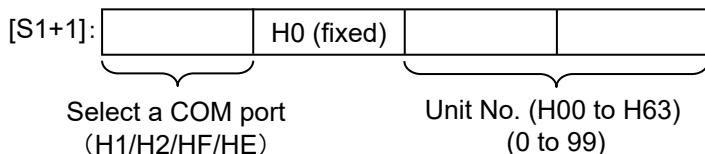

COM port selection (upper four bits)	H1	H2	HF	HE
Port number	COM1	COM2	COM0	Port number specified for the F469 (UNITSEL) instruction

### ■ MODBUS command specification

Depending on the transfer method specified for operand [S1] and the device type specified for operand [S2], the function code of MODBUS command to be sent varies.

Type of device specified in [S2]	Transfer method specified in [S1]	MODBUS function code to be sent
16-Bit device: WX, WY, WR, WL, DT, LD	Register transmission	Force multiple coils (15) Preset multiple registers (16)
1-Bit device: X, Y, R, L	Bit transmission	Force multiple coils (15)

### ■ Specifying destination unit area [D], [n]

The area of the destination unit is specified by the combination of operands [D] and [n].

- When [D] = DT0 and [n] = K100, the memory area of the destination unit starts with DT100. If the firmware of the main unit is earlier than Ver. 1.20, an operation error occurs when [n] is H8000 or higher. If the firmware of the main unit is Ver. 1.20 or later, the following specifications can be used.
- When [D] = DT0 and [n] = HFFF0, the memory area of the destination unit starts with DT65520.

### ■ Specifying a COM port number for the F469 (UNITSEL) instruction (only for the type with Ethernet Function)

Specifying HE in the upper four bits of [S1+1] of F145 (SEND) enables operand [S2] for the F469 (UNITSEL) instruction. The following figure shows that the F469 (UNITSEL) instruction specifies S1=K0 (serial communication port) and S2=K1 (COM1).

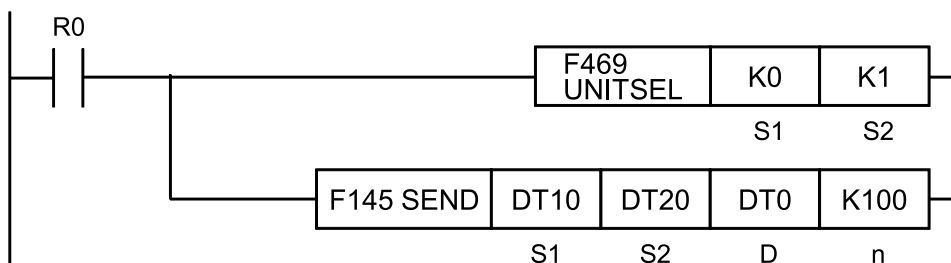

## 8.1 Serial Communication Instructions

[S2] of F469 (UNITSEL)	K0	K1	K2
Port number	COM0	COM1	COM2

### **i** Info.

- This is convenient to write data into Panasonic's PLC via MODBUS RTU.
- For MODBUS reference Nos. and device Nos., see "6.1.2 Device No. Correspondence Table".

### ■ MODBUS command specification example

#### Sending command 05 (single Y/R write)

- Example 1) Transfer from COM1 of the value in 0th bit of WR3 to 1st bit of WY1 in destination unit number 7

#### [F145(SEND), DT10, WR3, WY0, K1]

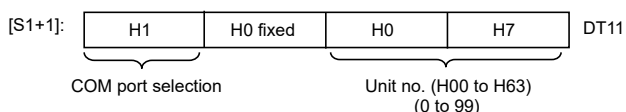
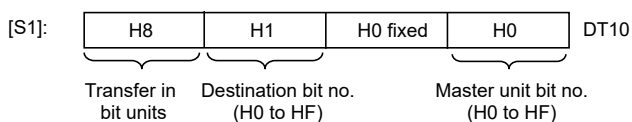

[S1]: DT10 (DT10=8100H, DT11=1007H)  
 [S2]: WR3 (WR3=0007H)  
 [D]: WY0  
 [n]: K1

Command conversion

MODBUS command	
1	Slave address      07
2	Command (05H)      05
3	Coil number (H)      00
4	Coil number (L)      11
5	Set state (H)      FF
6	Set state (L)      00
7	CRC16(H)      DC
8	CRC16(L)      59

(Note 1) When sending command 05, set [S1] transfer method specification to bit units (H8).

(Note 2) Depending on whether WR3 0th bit is ON or OFF, [S1+1] settings status will be set.  
 Set ON=FF00, set OFF=0000

(Note 3) The write target coil number is specified as Y11. (destination unit)

#### Sending command 06 (DT1 word write)

- Example 2) Transfer from COM1 of 1 word of data from WR3 to DT1000 in destination unit number 7

#### [F145(SEND), DT10, WR3, DT0, K1000]

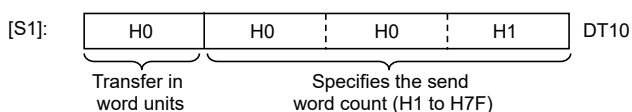

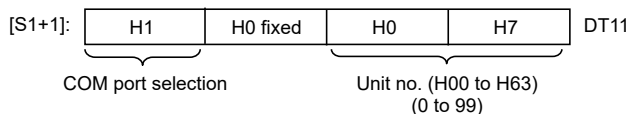

[S1]: DT10 (DT10=0001H, DT11=1007H)  
[S2]: WR3 (WR3=1234H)  
[D]: DT0  
[n]: K1000

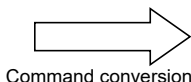

MODBUS command	
1	Slave address      07
2	Command (06H)      06
3	Write start number (H)    03
4	Write start number (L)    E8
5	Write data (H)          12
6	Write data (L)          34
7	CRC16(H)              04
8	CRC16(L)              AB

(Note 1) When sending command 06, set [S1] transfer method specification to word units (H0), and set transfer word number to (H1).

(Note 2) Reads WR3 word data and sets it as write data.

### Sending command 15 (multiple point Y/R write)

- Example 3) Transfer from COM1 of 64 bits of data from WR3 0th bit to WR6 Fth bit to Y0–Y3F in destination unit number 7

### [F145(SEND), DT10, WR3, WY0, K0]

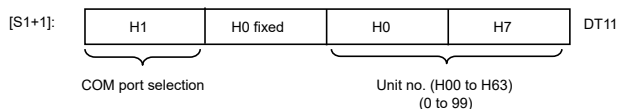
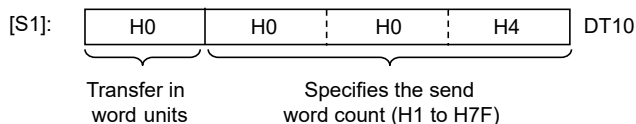

[S1]: DT10 (DT10=0004H, DT11=1007H)  
[S2]: WR3 (WR3=3210H  
WR4=7654H  
WR5=BA98H  
WR6=FEDCH)

[D]: WY0  
[n]: K0

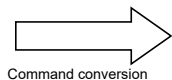

MODBUS command	
1	Slave address      07
2	Command (0FH)      0F
3	State change startnumber (H)    00
4	State change start number (L)    00
5	Change coil count (H)      00
6	Change coil count (L)      40
7	Data count (byte count)    08
8	Set data 1          10
9	Set data 2          32
10	Set data 3          54
11	Set data 4          76
12	Set data 5          98
13	Set data 6          BA
14	Set data 7          DC
15	Set data 8          FE
16	CRC16(H)          6C
17	CRC16(L)          B3

## 8.1 Serial Communication Instructions

- (Note 1) When sending command 15, set [S1] transfer method specification to word units (H0).
- (Note 2) Status change start number will be set to write target coil number. (destination unit)
- (Note 3) Change coil number will change write bit number to HEX.
- (Note 4) Due to MODBUS protocol limits, change coil number maximum is 2032 (07F0H).  
Data number (byte number) is calculated as 1 data (1 byte) for 8 coils. [Max 254 (FEH) bytes]

### Sending command 16 (DT multiple word write)

- Example 4) Transfer from COM1 of 3 words of data from WR3 to WR5 to DT500–DT502 in destination unit number 7

#### [F145(SEND), DT10, WR3, DT0, K500]

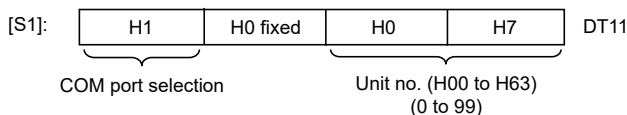
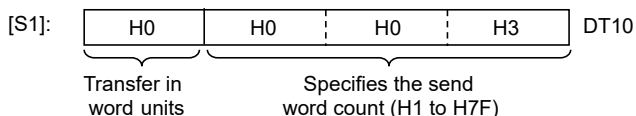

[S1]: DT10 (DT10=0003H, DT11=1007H)

[S2]: WR3 (WR3=0011H  
WR4=2233H  
WR5=4455H)

[D]: DT0  
[n]: K500

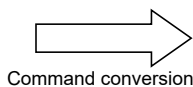

MODBUS command		
1	Slave address	07
2	Command (10H)	10
3	Write start number (H)	01
4	Write start number (L)	F4
5	Write register count (H)	00
6	Write register count (L)	03
7	Data count (byte count)	06
8	Write data 1 (H)	00
9	Write data 1 (L)	11
10	Write data 2 (H)	22
11	Write data 2 (L)	33
12	Write data 3 (H)	44
13	Write data 3 (L)	55
14	CRC16(H)	5A
15	CRC16(L)	E7

- (Note 1) When sending command 16 set [S1] transfer method specification to word units (H0).
- (Note 2) Due to MODBUS protocol limits, write resistor number maximum is 127 (7FH).
- (Note 3) Data number (byte number) is calculated as 2 bytes for write resistor number. [Max 254 (FEH) bytes]

### ■ Flag operations

Name	Description
R9007	Turns ON when the [S1] / [S1+1] control data value is outside the specified range.
R9008	Turns ON when the [S2] or [D] area is exceeded, if the number of words specified in [S1] is taken during transfer in word units.
(ER)	Turns ON when [D]+[n] exceeds the [D] area



Name	Description
	Turns ON when the COM port specification of control data specified in [S1+1] is not MODBUS mode.
	Turns ON when the [D] area is DT during transfer in bit units.
	Turns ON when the [D] device number is not 0.

### 8.1.7 F146 RECV [MODBUS Master Receiver: No Function Code Specification (Serial Communication)]

#### ■ Instruction format

**For Type without Ethernet Function**

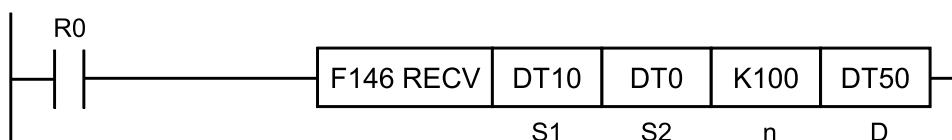

**For Type with Ethernet Function**



- When using both the serial communication and Ethernet communication within a program, specify the serial communication port using the F469 (UNITSEL) instruction before executing the F146 (RECV) instruction.

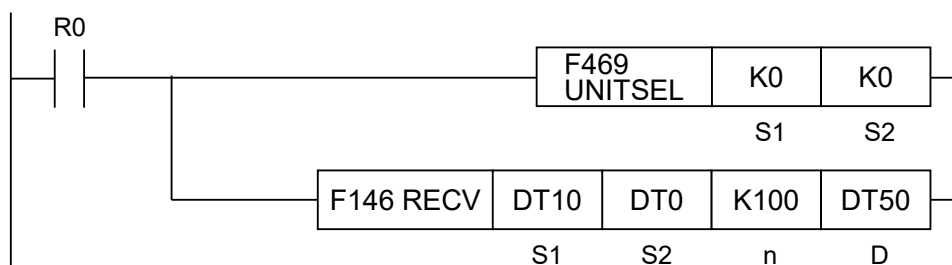

#### ■ Operands

Operands	Settings	
S1	Specify the starting number of the area (2 words) that stores control data.	
	S1	Specify the transfer method. Word transfer: Specify the number of send words. Bit transfer: Specify the bit number of a master unit and that of a destination unit.
	S1+1	Specify the COM port No. of a master unit and the unit number of a destination unit.
S2	Specification of a destination unit	Specify the source data area of a destination unit. (Device No. is fixed to "0")

## 8.1 Serial Communication Instructions

Operands	Settings	
n	Specification of a destination unit	Specify the starting address of the device in the source data area of a destination unit.
D	Specification of a master unit	Specify the device starting address of the receive data storage area in the master unit.

### ■ Devices that can be specified (indicated by ●)

Operands	WX	WY	WR	WL	SV	EV	DT	LD	In	SW R	SDT	Constant		Index modifier (Note 1)
												K	H	
S1	●	●	●	●	●	●	●	●		●	●			●
S2	●	●	●	●			●	●						
n		●	●	●	●	●	●	●				●	●	●
D		●	●	●	●	●	●	●						●

(Note 1) A character constant cannot be specified.

### ■ Specifying control data [S1]

#### Specification of [S1]

To [S1], the following specification should be applied. The specification method differs depending on word transfer and bit transfer.

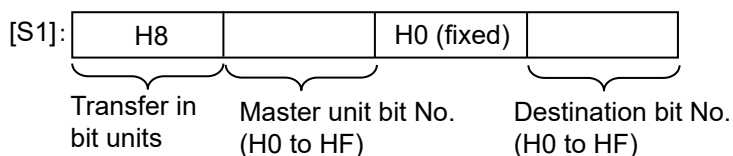
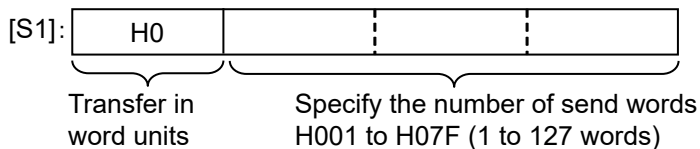

#### Specification of [S1+1]

To [S1+1], the following specification should be applied.

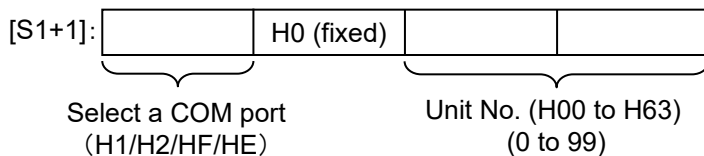

COM port selection (upper 4 bits)	H1	H2	HF	HE
Port number	COM1	COM2	COM0	Port number specified for the F469 (UNITSEL) instruction

### ■ Selecting MODBUS function code

Depending on the transfer method specified for operand [S1] and the device type specified for operand [D], the function code of MODBUS command to be sent varies.

Device type specified for [D]	Transfer method specified for [S1]	MODBUS function code to be sent
16-Bit device: WX, WY, WR, WL, DT, LD	Register transmission	H1: Read coil state (01) H2: Read input state (02) H3: Read hold register (03) H4: Read input register (04)
1-Bit device: X, Y, R, L	Bit transmission	H1: Read coil state (01) H2: Read input state (02)

### ■ Specifying destination unit area [S2], [n]

The area of the destination unit is specified by the combination of operands [S2] and [n].

- When [S2] = DT0 and [n] = K100, the memory area of the destination unit starts with DT100. If the firmware of the main unit is earlier than Ver. 1.20, an operation error occurs when [n] is H8000 or higher. If the firmware of the main unit is Ver. 1.20 or later, the following specifications can be used.
- When [S2] = DT0 and [n] = HFFF0, the memory area of the destination unit starts with DT65520.

### ■ Specifying a COM port number for the F469 (UNITSEL) instruction (only for the type with Ethernet Function)

Specifying HE in the upper four bits of [S1+1] of the F146 (RECV) enables operand [S2] for the F469 (UNITSEL) instruction. The following figure shows that the F469 (UNITSEL) instruction specifies S1=K0 (serial communication port) and S2=K1 (COM1).

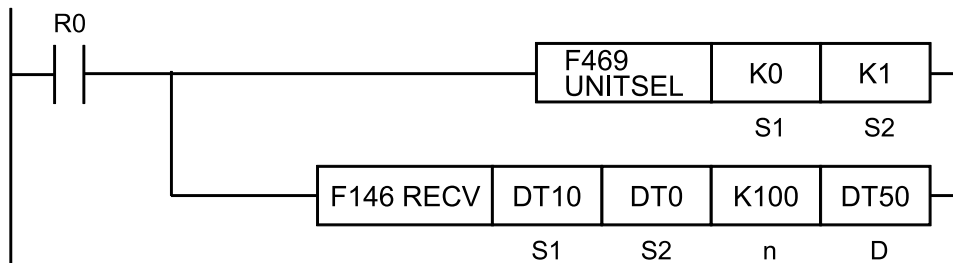

[S2] of F469 (UNITSEL)	K0	K1	K2
Port number	COM0	COM1	COM2

### **i** Info.

- This is convenient to read data from Panasonic PLC via MODBUS-RTU.
- For MODBUS reference Nos. and device Nos., see "[6.1.2 Device No. Correspondence Table](#)".

## 8.1 Serial Communication Instructions

### ■ MODBUS command specification example

#### Sending command 01 (Y/R coil read)

- Example 1) Sending command from COM1 to read 1 bit (Y17) of destination unit number 17 and to transfer read bit data to 5th bit of master unit DT100

#### [F146(RECV), DT10, WY0, K1, DT100]

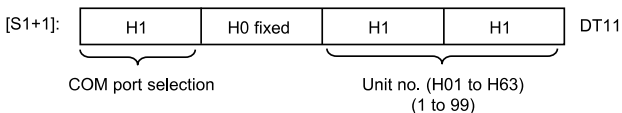
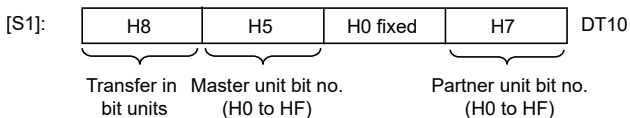

[S1]: DT10 (DT10=8507H, DT11=1011H)  
 [S2]: WY0  
 [n]: K1  
 [D]: DT100

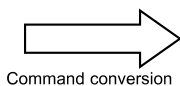

MODBUS command	
1	Slave address      11
2	Command (01H)      01
3	Read start number (H)      00
4	Read start number (L)      17
5	Read count (H)      00
6	Read count (L)      01
7	CRC16(H)      DC
8	CRC16(L)      59

(Note 1) When reading only 1 bit with command 01, set [S1] transfer method specification to bit units (H8).

(Note 2) The read start number specifies the read location coil number. (Destination unit: Y17)

(Note 3) The read number will be 1.

- Example 2) Sending command from COM1 to read 64 bits (4 words) (Y10–Y4F) from destination unit number 17 and to transfer read bit data to master unit starting at DT100

#### [F146(RECV), DT10, WY0, K1, DT100]

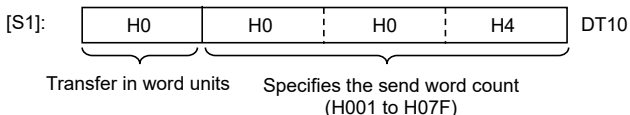

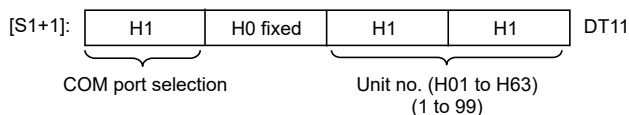

[S1]: DT10 (DT10=0004H, DT11=1011H)  
[S2]: WY0  
[n]: K1  
[D]: DT100

MODBUS command

1	Slave address	11
2	Command (01H)	01
3	Read start number (H)	00
4	Read start number (L)	10
5	Read count (H)	00
6	Read count (L)	40
7	CRC16(H)	3E
8	CRC16(L)	AF

Command conversion

(Note 1) When reading word units with command 01, set [S1] transfer method specification to bit units (H0).

(Note 2) The read start number specifies the read location coil number. (Destination unit: Y10)

(Note 3) The read number will be the specified number of words × 16. (64-bit reading)

### Sending command 02 (X contact reading)

- Example 3) Sending command from COM1 to read 1 bit (X17) from destination unit number 17 and to transfer read bit data to 5th bit of master unit DT100

#### [F146(RECV), DT10, WX0, K1, DT100]

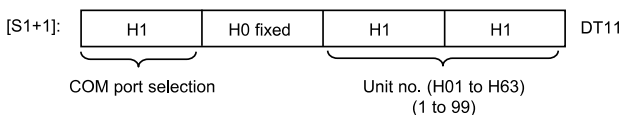
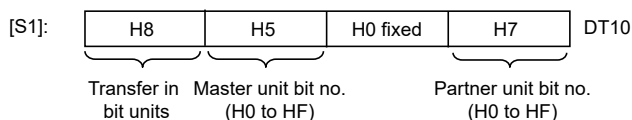

[S1]: DT10 (DT10=8507H, DT11=1011H)  
[S2]: WX0  
[n]: K1  
[D]: DT100

MODBUS command

1	Slave address	11
2	Command (02H)	02
3	Read start number (H)	00
4	Read start number (L)	17
5	Read count (H)	00
6	Read count (L)	01
7	CRC16(H)	0B
8	CRC16(L)	5E

Command conversion

(Note 1) When reading only 1 bit with command 02, set [S1] transfer method specification to bit units (H8).

(Note 2) The read start number specifies the read location coil number. (Destination unit: X17)

(Note 3) The read number will be 1.

- Example 4) Sending command from COM1 to read 64 bits (4 words) (X10–X4F) from destination unit number 17 and to transfer read bit data to master unit starting at DT100

## 8.1 Serial Communication Instructions

### [F146(RECV), DT10, WX0, K1, DT100]

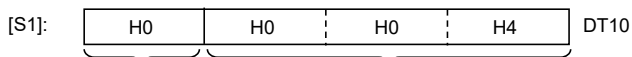

Transfer in word units      Specifies the send word count  
(H001 to H07F)

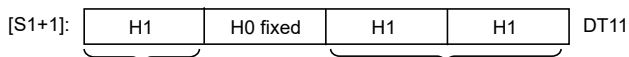

COM port selection      Unit no. (H01 to H63)  
(1 to 99)

[S1]: DT10 (DT10=0004H, DT11=1011H)

[S2]: WX0

[n]: K1

[D]: DT100

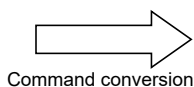

Command conversion

MODBUS command		
1	Slave address	11
2	Command (02H)	02
3	Read start number (H)	00
4	Read start number (L)	10
5	Read count (H)	00
6	Read count (L)	40
7	CRC16(H)	7A
8	CRC16(L)	A0

(Note 1) When reading word units with command 02, set [S1] transfer method specification to bit units (H0).

(Note 2) The read start number specifies the read location coil number. (Destination unit: X10)

(Note 3) The read number will be the specified number of words × 16. (64-bit reading)

### Sending command 03 (DT read)

- Example 5) Sending command from COM1 to read 6 words (DT500–DT505) from destination unit number 17 and to transfer read bit data to master unit starting at DT100

### [F146(RECV), DT10, DT0, K500, DT100]

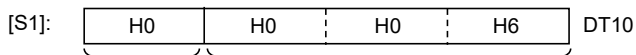

Transfer in word units      Specifies the send word count  
(H001 to H07F)

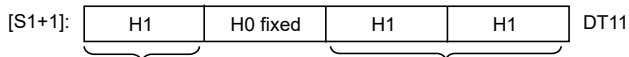

COM port selection      Unit no. (H01 to H63)  
(1 to 99)

[S1]: DT10 (DT10=0006H, DT11=1011H)

[S2]: DT0

[n]: K500

[D]: DT100

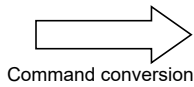

Command conversion

MODBUS command		
1	Slave address	11
2	Command (03H)	03
3	Read start number (H)	01
4	Read start number (L)	F4
5	Read count (H)	00
6	Read count (L)	06
7	CRC16(H)	87
8	CRC16(L)	56

(Note 1) When reading word units with command 03 set [S1] transfer method specification to word units (H0).

(Note 2) The read start number specifies the read location data number. (Destination unit: DT500)

(Note 3) The read number will be the specified number of words. (6-word reading)

### Sending command 04 (WL/LD read)

- Example 6) Sending command from COM1 to read 6 words (WL20–WL25) from destination unit number 17 and to transfer read bit data to master unit starting at DT100

#### [F146(RECV), DT10, WL0, K20, DT100]

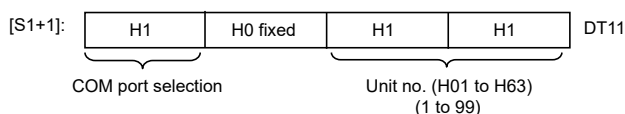
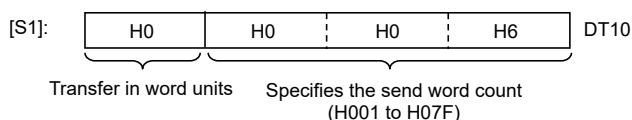

[S1]: DT10 (DT10=0006H, DT11=1011H)  
 [S2]: WL0  
 [n]: K20  
 [D]: DT100

MODBUS command

1	Slave address	11
2	Command (04H)	04
3	Read start number (H)	00
4	Read start number (L)	14
5	Read count (H)	00
6	Read count (L)	06
7	CRC16(H)	32
8	CRC16(L)	9C

Command conversion

(Note 1) When reading word units with command 04 set [S1] transfer method specification to word units (H0).

(Note 2) The read start number specifies the read location data number. (Destination unit: WL20)

(Note 3) The read number will be the specified number of words. (6-word reading)

- Example 7) Sending command from COM1 to read 6 words (LD100–LD105) from destination unit number 17 and to transfer read bit data to master unit starting at DT100

#### [F146(RECV), DT10, LD0, K100, DT100]

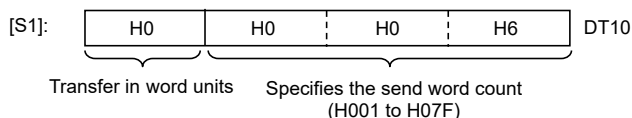

## 8.1 Serial Communication Instructions

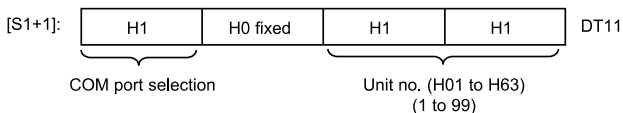

[S1]: DT10 (DT10=0006H, DT11=1011H)  
 [S2]: LD0  
 [n]: K100  
 [D]: DT100

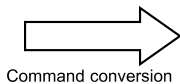

MODBUS command	
1	Slave address 11
2	Command (04H) 04
3	Read start number (H) 08
4	Read start number (L) 34
5	Read count (H) 00
6	Read count (L) 06
7	CRC16(H) 31
8	CRC16(L) 36

- (Note 1) When reading word units with command 04 set [S1] transfer method specification to word units (H0).
- (Note 2) The read start number specifies the read location data number. (Destination unit: LD100)
- (Note 3) The read number will be the specified number of words. (6-word reading)
- (Note 4) If LD is specified, it is 07D0H(LD0) onward.

### ■ Flag operations

Name	Description
R9007 R9008 (ER)	Turns ON when the [S1] / [S1+1] control data value is outside the specified range.
	Turns ON when the [S2] or [D] area is exceeded, if the number of words specified in [S1] is taken during transfer in word units.
	Turns ON when [S2]+[n] exceeds the [S2] area.
	Turns ON when the COM port specification of control data specified in [S1+1] is not MODBUS mode.
	Turns ON when the [S2] area is DT / WL / LD, during transfer in bit units.
	Turns ON when the [S2] device number is not 0.

### 8.1.8 F159 MTRN [General-purpose Communication Instructions (Serial Communication)]

#### ■ Instruction format

For Type without Ethernet Function

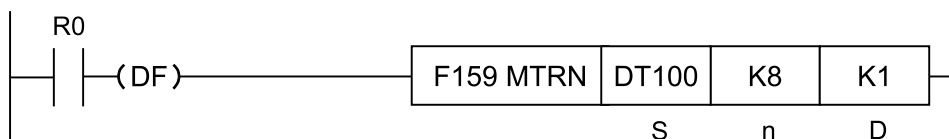



### For Type with Ethernet Function



- When using both the serial communication and Ethernet communication within a program, specify the serial communication port using the F469 (UNITSEL) instruction before executing the F159 (MTRN) instruction.

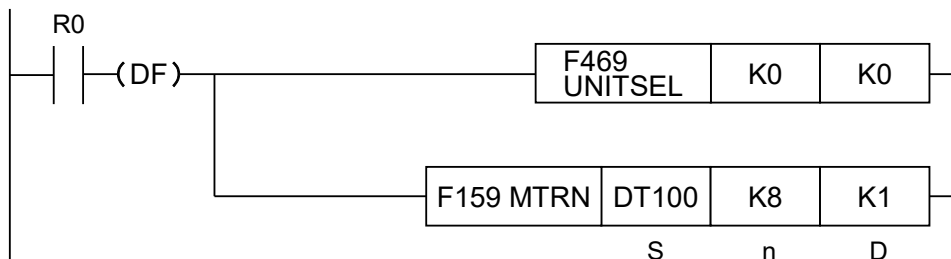

### ■ Operands

Items	Settings
S	Starting area (data register) of the data table
n	Area storing the number of bytes of data to be sent, or constant data <ul style="list-style-type: none"> <li>Add the terminator (end code) during transmission when the value is positive.</li> <li>Do not add the terminator (end code) during transmission when the value is negative.</li> <li>In the case of H8000, the purpose of COM port is switched.</li> </ul>
D	COM port number for sending data (K0/K1/K2/K14)

### ■ Devices that can be specified (indicated by ●)

Operands	WX	WY	WR	WL	SV	EV	DT	LD	I	Constant		Index modifier (Note 1)
										K	H	
S							●					●
n	●	●	●	●	●	●	●	●	●	●	●	●
D										●		●

(Note 1) A character constant cannot be specified.

### ■ Outline of operation

Data is sent or received with an external device connected to the COM port. F159 (MTRN) instruction has the following three functions.

Items	Description
Send	In the data register starting with [S], data to be sent to an external device is set as a table in advance. By executing the [F159 MTRN] instruction, data of [n] bytes is sent from the COM port to an external device.
Receive	Data sent to COM port is stored in the receive buffer (data register DT) specified by the system register. Once the reception is done, the “reception done flag” turns on, and disables further reception. When the [F159 MTRN] instruction is executed, the “reception done flag” turns OFF, and enables reception. The F159 (MTRN) instruction is used to turn OFF the reception done flag for general-purpose communication (i.e. to enable reception).

## 8.1 Serial Communication Instructions

Items	Description
Operation mode switching	Operation mode of COM port can be switched between “general-purpose communication mode” and “computer link mode”.

### ■ System register settings

- Using the system register, it is required to set to “general-purpose communication mode” in COM port.
- Using the system register, it is required to align the baud rate and transmission format with an external device.
- To secure an area for storing receive data in the data register (DT), it is required to specify “Receive buffer starting number in general-purpose communication” and “Receive buffer capacity in general-purpose communication” using the system register.

### ■ Related flag /system register No.

	Operation	COM0	COM1	COM2
Communication error flag	0: Normal 1: Error	R9130	R9138	R9140
Operation mode flag	0: Other than general-purpose communication 1: General-purpose communication	R9131	R9139	R9141
Reception done flag	0: Reception enabled 1: Reception disabled (reception done)	R9132	R913A	R9142
Transmission done flag	0: Transmission in progress 1: Transmission done (transmission enabled)	R9133	R913B	R9143
Receive buffer starting number	Specify the DT range to be used as a receive buffer, using the system register.	No.420	No.416	No.418
Receive buffer capacity		No.421	No.417	No.419

### ■ Specifying COM port number [D1]

Specify the COM port number as shown below.

Port specification with the F469 (UNITSEL) instruction is only applicable to the type with Ethernet Function.

[D]	K0	K1	K2	K14
Port number	COM0	COM1	COM2	Port number specified for the F469 (UNITSEL) instruction

### ■ Creation of send data table [S]

- Send data is stored as follows in a given memory area (e.g. data register DT). The number of send data bytes [n] is automatically added to the starting word. Send data should be stored in [S+1] and later.
- Do not include the terminator in the send data. The terminator is added automatically. When no terminator is to be added during transmission, specify a negative value for [n]. Alternatively, select “None” from the terminator setting in the system register.

- When the header (start code) is set to “STX” in system register, do not add the header to send data. The header is added automatically.

**Example: When 8-byte data “ABCDEFGH” is sent with [S] as DT100**

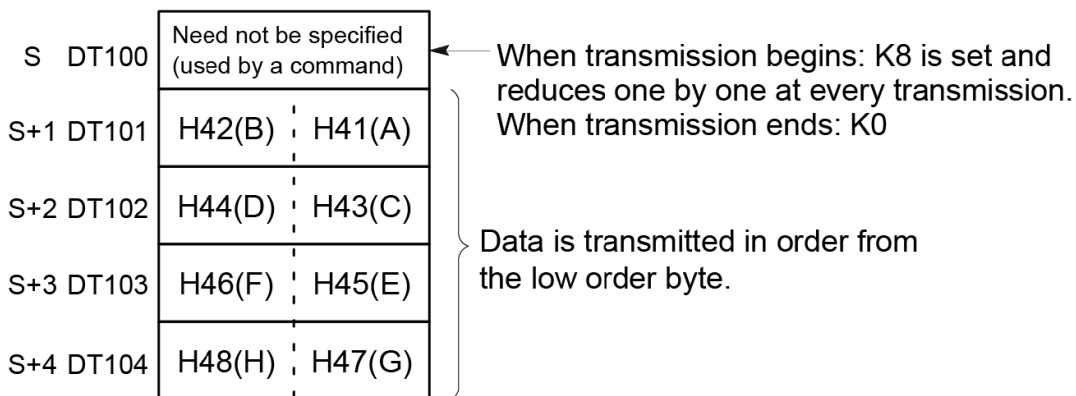

Data table before transmission

■ **Precautions during programming**

- F159 (MTRN) instruction should be executed after confirming that the transmission done flag for the target COM port has turned ON.
- The maximum data that can be sent in a single session is 2,048 bytes.

■ **Structure of receive data**

Receive data is stored in the receive buffer (data register DT) specified in the system register. The number of receive data bytes is stored in the starting word.

**Example: When 8-byte data “ABCDEFGH” is received**

Specify 200 for the “receive buffer starting number”, and 5 for the “receive buffer capacity”, in the system register.

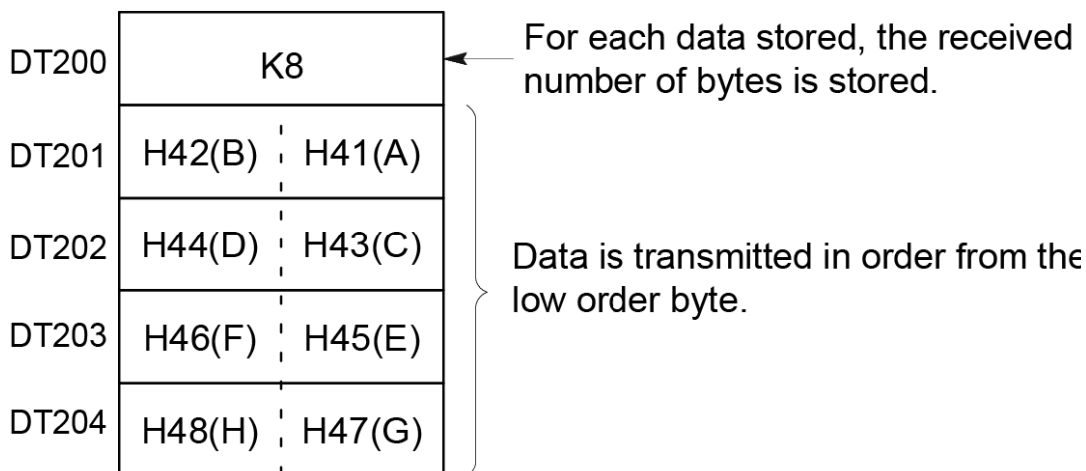

Receive buffer at the time of reception complete

## 8.1 Serial Communication Instructions

### ■ Operations when data is received

When the reception done flag is OFF, operation takes place as follows when data is sent from an external device.

	Items	Description
(1)	Storage of receive data	Incoming data is stored in ascending order from the lower-order byte of the 2nd-word area of the receive buffer. Header and terminator (start and end codes) are not stored.
(2)	Reception done flag ON	When the terminator (end code) is received, the reception done flag turns ON. Reception of any further data is prohibited.
(3)	Execute F159 (MTRN) instruction	When an F159 (MTRN) instruction is executed, the reception done flag turns OFF. The number of received bytes in the receive buffer starting number is cleared. Data in the receive buffer is not cleared.
(4)	Storage of the following receive data	Reception is enabled when the reception done flag turns OFF, and the storage of receive data is restarted.

### ■ Specifying a COM port number for the F469 (UNITSEL) instruction (only for the type with Ethernet Function)

Specifying K14 for [D] of F159 (MTRN) enables operand [S2] for F469 (UNITSEL). The following figure shows that the F469 (UNITSEL) instruction specifies S1=K0 (serial communication port) and S2=K1 (COM1).

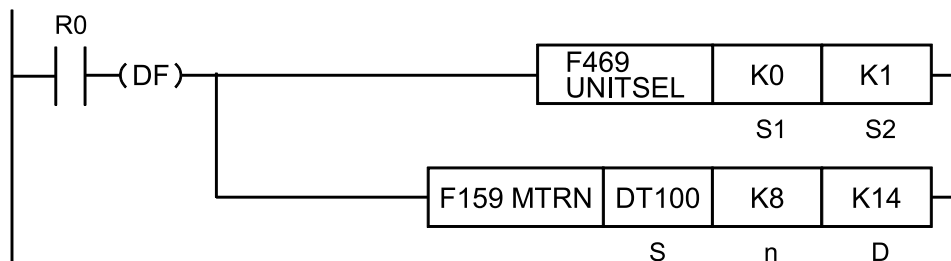

[S2] of F469 (UNITSEL)	K0	K1	K2
Port number	COM0	COM1	COM2

### ■ Flag operations

Name	Description
R9007	Turns ON when the area is exceeded in index modification
R9008	
(ER)	Turns ON when the data table exceeds the area in the specification of bytes in [n].

## 8.2 Character String Instructions

### 8.2.1 F253 SSET (Character Constant → ASCII Code Conversion: with Storage Area Size)

#### ■ Instruction format

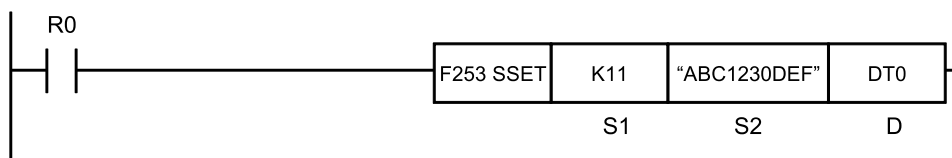

#### ■ Operands

Items	Settings
S1	Storage area size (permissible range: K1 to K32767, H8000)
S2	Character constant to be converted (permissible range: 0 to 256 characters)
D	Starting device address of the destination

#### ■ Devices that can be specified (indicated by ●)

Operands	WX	WY	WR	WL	SV	EV	DT	LD	I	SW R	SDT	Constant			Index modifier (Note 1)
												K	H	M	
S1	●	●	●	●	●	●	●	●	●			●	●		●
S2														●	
D		●	●	●	●	●	●	●	●						●

(Note 1) A character constant cannot be specified.

#### ■ Outline of operation

- When **S1** (storage area size) is K1 to K32767:  
The storage area size specified in **S1** is stored in **D**.  
The character constant specified by **S2** is converted into ASCII code. The number of characters (1 word) is stored in **D+1**, and ASCII converted character data is stored in **D+2** and the subsequent area, in ascending order from lower bytes.
- When **S1** (storage area size) is H8000:  
The character constant specified by **S2** is converted into ASCII code. The number of characters (1 word) is stored in **D**, and ASCII converted character data is stored in **D+1** and the subsequent area, in ascending order from lower bytes.
- A character constant is bracketed in "" (double quotation marks).
- Character constants can be set from 0 to 256 characters.
- A string that consists of "" (double quotation marks) only is regarded as NULL characters.
- NULL(00) is not added to the end of characters during setting.

## 8.2 Character String Instructions

### ■ Processing

**Example 1) When a string "ABC1230 DEF" (11 characters including a space) is to be converted**

S1...K12 S2... "ABC1230 DEF" D...DT0

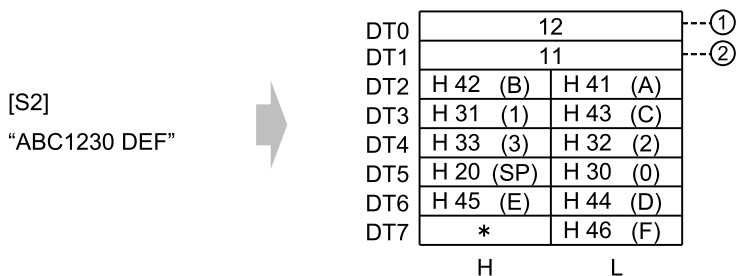

(Note 1) Data outside the range in the destination (\*) (bytes higher than DT7) does not change.

(1)	Storage area size	(2)	Number of characters
-----	-------------------	-----	----------------------

**Example 2) With the 16 characters from A to P as one set, when 16 sets (256 characters in total) are to be repeatedly converted**

S1...K256 S2... "ABCDEF...KLMNOP" D...DT0

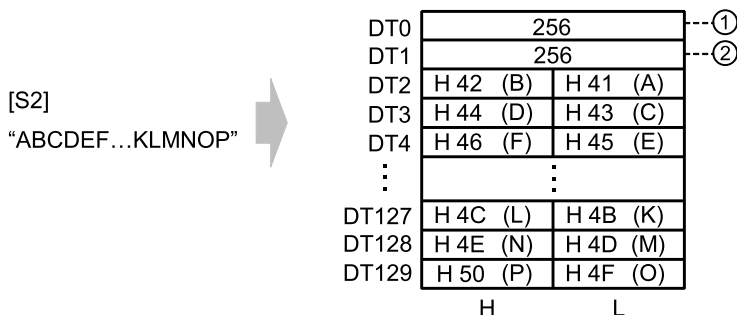

(1)	Storage area size	(2)	Number of characters
-----	-------------------	-----	----------------------

**Example 3) A string of zero character bracketed by "" (i.e. double quotation marks in sequel) is converted**

S1...K1 S2... "" D...DT0



(Note 1) Data outside the range in the destination (\*) (DT2 to DT7) does not change.

(1)	Storage area size	(2)	Number of characters
-----	-------------------	-----	----------------------

**Example 4) When a string “ABC1230 DEF” (11 characters including a space) is to be converted**

S1...H8000 S2... “ABC1230 DEF” D...DT0

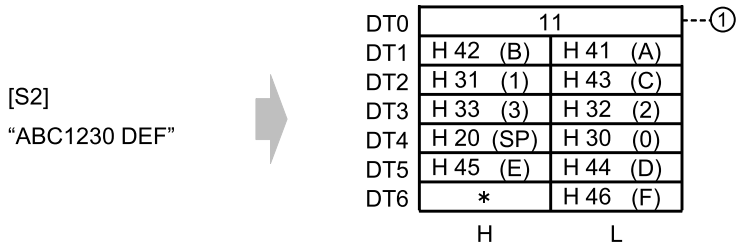

(Note 1) Data outside the range in the destination (\*) (bytes higher than DT6) does not change.

(1)	No. of characters
-----	-------------------

**Example 5) With the 16 characters from A to P as one set, when 16 sets (256 characters in total) are to be repeatedly converted**

S1...H8000 S2... “ABCDEF...KLMNOP” D...DT0

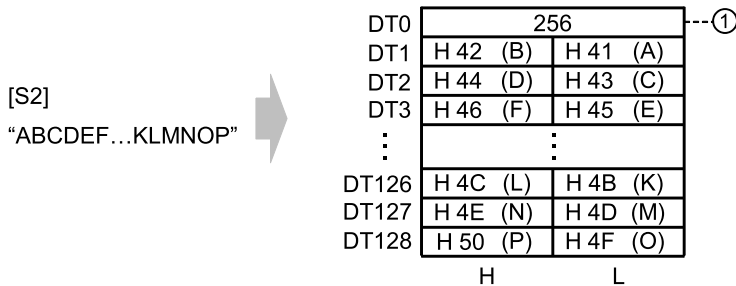

(1)	No. of characters
-----	-------------------

**Example 6) A string of zero character bracketed by “” (i.e. double quotation marks in sequel) is to be converted**

S1...H8000 S2... “” D...DT0

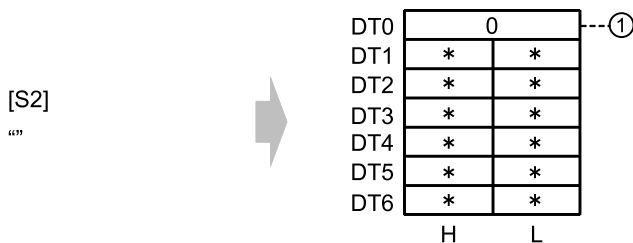

(Note 1) Data outside the range in the destination (\*) (DT1 to DT6) does not change.

(1)	No. of characters
-----	-------------------

## 8.2 Character String Instructions

---

### ■ Flag operations

Name	Description
R9007 R9008 (ER)	Turns ON when the area is exceeded in index modification.
	Turns ON when the accessible range is exceeded if the storage area size starting with <b>D</b> is secured.
	Turns ON when a value outside the permissible range is specified for <b>S1</b> .
	Turns ON when the number of characters is larger than the storage area size.



### 8.3 Ethernet Instruction (Only For Type with Ethernet Function)

#### 8.3.1 [F469 UNITSEL] (Communication Unit Slot Port Specification)

##### ■ Instruction format

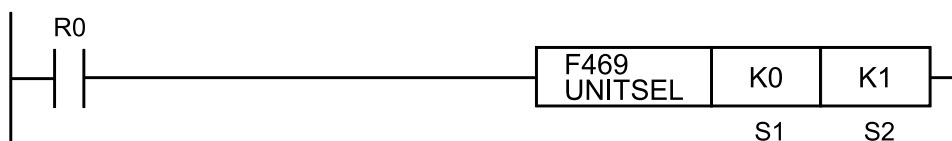

##### ■ Operands

Items	Settings
S1	Unit communication port (K0: Serial communication)
S2	Ignored when S1=K0 (Note 1)

(Note 1) If you use the F145 SEND, F146 RECV, or F159 MTRN instruction to enable port number specification in F469 UNITSEL, you can specify a COM port number for operand [S2].

##### ■ Devices that can be specified (indicated by ●)

Opera nds	WX	WY	WR	WL	SV	EV	DT	LD	FL	I	SWR	SDT	Constant			Index modifier (Note 1)
													K	H	M	
S1	●	●	●	●	●	●	●	●		●	●	●	●	●		●
S2	●	●	●	●	●	●	●	●		●	●	●	●	●		●

(Note 1) A character constant cannot be specified.

##### ■ Outline of operation

- For the type with Ethernet Function, specify this instruction immediately before one of the following communication instructions to specify the execution target of each instruction.  
F145 SEND, F146 RECV, and F159 MTRN
- For serial communication, specify a communication port (K0: serial communication port) for [S1].
- If you specify a communication port (K0: serial communication port) for [S1], the specification of [S2] will be disabled.

##### ■ Specifying [S1] and [S2]

- For [S1], specify the communication port of the unit. The setting value of [S1] is stored in special data register DT90890.
- For [S2], specify a port number. (This specification is invalid for serial communication.) The setting value of [S2] is stored in special data register DT90891.

### 8.3 Ethernet Instruction (Only For Type with Ethernet Function)

Unit type	[S1] Slot number	[S2]
Serial communication	K0	Invalid

#### ■ Program example

Example) Specification of serial communication

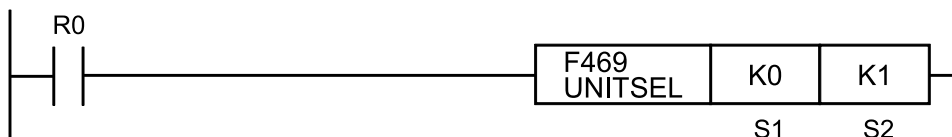

#### ■ Specifying a COM port number for F469 (UNITSEL) instruction

If you use the F145 SEND, F146 RECV, or F159 MTRN instruction to enable port number specification in F469 UNITSEL, you can specify a COM port number for operand [S2]. The following figure shows that the F469 (UNITSEL) instruction specifies S1=K0 (serial communication port) and S2=K1 (COM1).

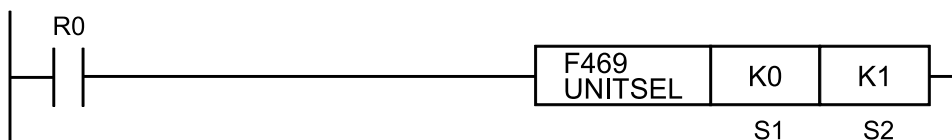

[S2] of F469 (UNITSEL)	K0	K1	K2
Port number	COM0	COM1	COM2

#### ■ Flag operations

Name	Description
R9007	This flag is set when the range is exceeded during indirect access (index modification).
R9008	When the slot specified by [S1] does not exist (slot number is outside the range)
(ER)	When the connection specified by [S2] does not exist (connection number is outside the range)

## 8.4 Special Instruction

### 8.4.1 SYS1 (Communication Condition Setting)

#### ■ Instruction format

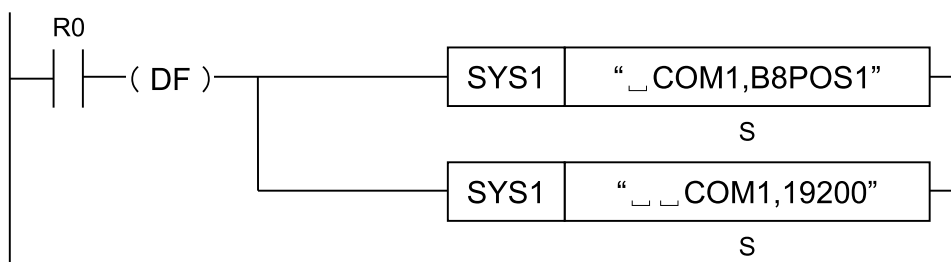

(Note 1) In the example shown in the figure above, the transmission format and baud rate of the COM1 port are set as below.

Character bit length: 8; Parity bit: Odd parity; Stop bit: 1

Baud rate: 19200 bps

#### ■ Operands

Items	Settings
S	Character constant

#### ■ Devices that can be specified (indicated by ●)

Operand s	WX	WY	WR	WL	SV	EV	DT	LD	I	SWR	SDT	Constant			Index modifier (Note 1)
												K	H	M	
S														●	

(Note 1) A character constant cannot be specified.

#### ■ Outline of operation

- This instruction changes the communication conditions of the port specified as the first keyword to the contents specified as the second keyword.
- The following functions can be changed.
  - Transmission format
  - Baud rate
  - Unit number setting (direct / indirect)
  - COM response control
  - Header and terminator
  - End time
  - RS (Request to Send) control

## 8.4 Special Instruction

### ■ Precautions on programming

- Enclose the first and second keywords in double quotation marks ("").
- Separate the first keyword and second keyword with a comma (,) without inserting a space.
- Insert space characters in front of the first keyword so that the total number of characters of the first and second keywords is 12. (The number of space characters to be inserted in front of the first keyword is 12 minus the total number of characters to be entered for the keywords.)

For FPWIN-GR7 Ver.2.23 or later, if the character constant consists of less than 12 characters, space characters will be automatically input (to compensate for the shortage of characters) when the project is converted.

Example: When entering COM1 as the first keyword and 19200 as the second keyword

Specified contents	"	␣	␣	C	O	M	1	,	1	9	2	0	0	"
No. of characters		1	2	3	4	5	6	7	8	9	10	11	12	

- Even if this instruction is executed, the contents of the system ROM in the main unit will not be rewritten. Therefore, when the power is turned OFF and then ON, the contents of the system ROM is rewritten with the contents of the system register specified in FPWIN GR7.
- We recommend that this instruction be executed as a differentiated instruction.
- Because the system register settings are changed, a verification error may occur when verification is performed with FPWIN GR7.

### ■ Specifying the communication conditions (transmission format)

- Specify transmission format (data length, parity check, and stop bit).

First keyword	Second keyword		
Ports to be used	Data length	Parity check	Stop bit
COM0: COM0 port COM1: COM1 port COM2: COM2 port TOOL: COM0 port	B7: 7 bits B8: 8 bits	PN: No parity PO: Odd parity PE: Even parity	S1: 1 S2: 2

### Setting examples

Example 1	S	"␣COM0,B7PNS1"
Settings	Port: COM0 / Data length: 7 bits / Parity check: None / Stop bit: 1	
Example 2	S	"␣COM1,B8PES2"
Settings	Port: COM1 / Data length: 8 bits / Parity check: Even parity / Stop bit: 2	
Example 3	S	"␣COM2,B8POS1"
Settings	Port: COM2 / Data length: 8 bits / Parity check: Odd parity / Stop bit: 1	

### ■ Specifying the communication conditions (baud rate)

- Specify a baud rate.

First keyword	Second keyword
Ports to be used	Baud rate
COM0: COM0 port	1200: 1200 bps      19200: 19200 bps      230400: 230400 bps
COM1: COM1 port	2400: 2400 bps      38400: 38400 bps
COM2: COM2 port	4800: 4800 bps      57600: 57600 bps
TOOL: COM0 port	9600: 9600 bps      115200: 115200 bps

(Note 1) If the baud rate is changed as below, communications passing through all COM ports will be reset.  
Baud rates of all COM ports: 4800 bps or higher ↔ Baud rate of any of the COM ports: 2400 bps or lower

(Note 2) If the baud rate of any of the COM ports is 2400 bps or lower, F-ROM access will slow down.  
Example) F12(ICRD) instruction, P13(ICWT) instruction, etc.

### Setting example

Example 1	S	"_COM0,19200"
Settings	Port: COM0 / 19200 bps	
Example 2	S	"_COM1,1200"
Settings	Port: COM1 / 1200 bps	
Example 3	S	"_COM2,115200"
Settings	Port: COM2 / 115200 bps	

### ■ Specifying the communication conditions (unit number)

- Specify a unit number directly or indirectly.

First keyword	Second keyword	
Ports to be used	Unit number (for direct specification)	Unit number (for indirect specification)
COM0: COM0 port COM1: COM1 port COM2: COM2 port TOOL: COM0 port	No1 to No99: Unit numbers 1 to 99	For a DT number that contains a unit number, specify D followed by a four-digit number, as below. D0000 to D9999: DT0 to DT9999

(Note 1) For direct specification of unit numbers, you can specify unit numbers 1 to 99. For indirect specification of unit numbers, specify a DT number that contains a unit number.

### Setting example

Example 1	S	"_COM0,No1"
Settings	(For direct specification of unit numbers) Port: COM0 / Unit number: No1	
Example 2	S	"_COM1,No99"
Settings	(For direct specification of unit numbers) Port: COM1 / Unit number: No99	
Example 3	S	"COM0No,D0000"

## 8.4 Special Instruction

Settings	(For indirect specification of unit numbers) Port: COM0 / Unit number: Value set in DT0
Example 4	S "COM2No,D0123"
Settings	(For indirect specification of unit numbers) Port: COM2 / Unit number: Value set in DT0123

### ■ Specifying the communication conditions (response time of COM port)

- Specify the response time of a COM port.

First keyword	Second keyword
Ports to be used	Response time
COM0: COM0 port COM1: COM1 port COM2: COM2 port TOOL: COM0 port	WAIT0 to WAIT999 (n=0 to 999) [When the communication mode is computer link or MODBUS RTU] Set time = Scan time x n [When the communication mode is PLC link] Set time = n μs

### Setting examples

Example 1	S	"_COM0, WAIT1"
Settings		Port: COM0 [When the communication mode computer link or MODBUS RTU] Scan time x 1 [When the communication mode is PLC link] 1 μs
Example 2	S	"COM1, WAIT999"
Settings		Port: COM1 [When the communication mode is computer link or MODBUS RTU] Scan time x 999 [When the communication mode is PLC link] 999 μs

### ■ Specifying the communication conditions (header / terminator)

- Specify a header or terminator.

First keyword	Second keyword	
Ports to be used	For header	For terminator
COM0: COM0 port COM1: COM1 port COM2: COM2 port TOOL: COM0 port	STX: With STX NOSTX: Without STX	ETX: ETX CR: CR CRLF: CR + LF NOTERM: No terminator TIME: Enables end time (Note 1)

(Note 1) The setting of TIME takes precedence over the settings of other terminators (EXT, CR, CRLF, and NOTERM).

### Setting example

Example 1	S	"_COM0, STX"
Settings		Port: COM0 / Header: With STX

Example 2	S	"____COM1,ETX"
Settings	Port: COM1 / Terminator: ETX	
Example 3	S	"____COM1,CR"
Settings	Port: COM1 / Terminator: CR	
Example 4	S	"_COM2,NOTERM"
Settings	Port: COM2 / Terminator: No terminator	
Example 5	S	"____COM2,TIME"
Settings	Port: COM2 / Terminator: Enables end time	

### ■ Specifying the communication conditions (end time)

- Specify an end time.

First keyword	Second keyword
<b>Ports to be used</b>	<b>End time</b>
COM0: COM0 port COM1: COM1 port COM2: COM2 port TOOL: COM0 port	Specify an end time in 0.01 ms increments between 0.01 and 100 ms. T0 to T10000: 0.01ms to 100ms

### Setting examples

Example 1	S	"____COM0,T0"
Settings	Port: COM0 / End time: Transfer time for approx. 4 bytes of data	
Example 2	S	"____COM1,T123"
Settings	Port: COM1 / End time: 1.23 ms	
Example 3	S	"_COM2,T10000"
Settings	Port: COM2 / End time: 100 ms	

### ■ Specifying the communication conditions (RS (Request to Send) control)

- RS control can be performed for 1-channel RS-232C type communication cassettes.
- RS control can only be set for the COM1 port.

First keyword	Second keyword
<b>Ports to be used</b>	<b>RS (Request to Send) control</b>
COM1: COM1 port	RTS1: Disables communication (turns ON the RS terminal) RTS0: Enables communication (turns OFF the RS terminal)

## 8.4 Special Instruction

### Setting example

Example 1	S	"COM1,RTS1"
Settings		Port: COM1 / RS (Request to Send) control: Disables communication
Example 2	S	"COM1,RTS0"
Settings		Port: COM1 / RS (Request to Send) control: Enables communication

### ■ Flag operations

Name	Description
R9007 R9008 (ER)	Set when non-keyword text or an out-of-range value is specified for the first and second keywords.
	Set when there is no comma between the first and second keywords.
	Set if no communication cassette is mounted when COM1 or COM2 is specified.
	Set if the baud rate or transmission format for COM1 is changed when COM1 is in PLC link mode.
	Set if the baud rate or transmission format is changed while the modem for the COM0, COM1, or COM2 port is being initialized.
	Set if the communication mode is set to any mode other than general-purpose communication mode when a header or terminator is set.
	Set if any communication cassette other than 1-channel RS-232C type communication cassettes is mounted when RS control is performed.
	Set if a unit number greater than the maximum unit number set in the system register is specified when COM1 is in PLC link mode.
Set if the communication speed is changed as below while F-ROM is being accessed. Baud rates of all COM ports: 4800 bps or higher ↔ Baud rate of any of the COM ports: 2400 bps or lower	



# 9 Troubleshooting

---

9.1 What to Do If an Error Occurs.....	9-2
9.1.1 Communication Error Occurs (RS-232C) .....	9-2
9.1.2 Communication Error Occurs (RS-485) .....	9-2

## 9.1 What to Do If an Error Occurs

### 9.1 What to Do If an Error Occurs

#### 9.1.1 Communication Error Occurs (RS-232C)

##### ■ Object

Product no.	Communication interface	Control unit	Cassette	
		COM0	COM1	COM2
Control Unit standard equipment	RS-232C (3-wire) x 1 channels	•		
AFP0HCCS1	RS-232C (5-wire) x 1 channel		•	
AFP0HCCS2	RS-232C (3-wire) x 2 channel		•	•
AFP0HCCS1M1	RS-485 x 1 channel		•	
	RS-232C (3-wire) x 1 channel			•

(Note 1) The RS-232C port of AFP0HCCS1 is a 5-wire type, and the RS/CS control can be performed.

(Note 2) The both 1-channel RS-485 and 1-channel RS-232C (3-wire type) can be used for AFP0HCCS1M1.

##### ■ Situation

The connection or setting may be incorrect.

##### ■ Solution

#### 1. Check the setting of the system register.

Check if the setting corresponding to the allocated communication port number is correct. When the PLC link, check if the link areas do not overlap.

#### 2. Check if the CS signal is on.

When the three-wire type is used, connect the RS signal and CS signal, and turn on the CS signal. When the five-wire type is used, check the communication cassette LED and the RS signal of the destination device

#### 3. Check the connection with the destination device.

Confirm that the SD terminal of the destination device is connected to the RD terminal of the PLC, and the RD terminal of the destination device is connected to the SD terminal of the PLC. Check that the both SG terminals are connected.

#### 9.1.2 Communication Error Occurs (RS-485)

##### ■ Object

Product no.	Communication interface	Allocated communication port no.		
		Control unit	Cassette mounting part	
		COM0	COM1	COM2
AFP0HCCM1	RS-485 x 1 channel		•	

Product no.	Communication interface	Allocated communication port no.		
		Control unit	Cassette mounting part	
		COM0	COM1	COM2
AFP0HCCS1M1	RS-485 x 1 channel		•	
	RC-232C x 1 channel			•

### ■ Situation

The connection or setting may be incorrect.

### ■ Solution

1. Check the setting of the system register.  
Check if the setting corresponding to the allocated communication port number is correct.  
When the PLC link, check if the link areas do not overlap.
2. Check if the terminal unit is correctly connected.  
Do not designate any unit other than those at both ends of the network as a terminal station.
3. Check if the transmission cables between the (+) transmission terminals and between the (-) transmission terminals of each device are securely connected.
4. Check if the transmission cables are within the specifications range.  
Use only one type of cable. Do not mix more than one type.

(MEMO)

# 10 Description

---

10.1	Communication Function Specifications .....	10-2
10.1.1	Communication Specifications of the Control Unit .....	10-2
10.1.2	Communication Cassette Specifications .....	10-2
10.2	List of System Registers .....	10-4
10.3	List of Special Relays (COM Communication) .....	10-12
10.4	List of Special Data Registers (COM Communication) .....	10-21
10.5	Error Codes Table .....	10-26
10.5.1	List of MEWTOCOL-COM/DAT Communication Error Codes .....	10-26
10.5.2	List of MODBUS Communication Error Codes .....	10-27
10.6	MEWTOCOL-COM Format .....	10-28
10.6.1	MEWTOCOL-COM Command Type .....	10-28
10.6.2	MEWTOCOL-COM Response Format .....	10-29
10.7	MODBUS RTU Format .....	10-31
10.7.1	MODBUS RTU Command Format .....	10-31
10.7.2	MODBUS RTU Response Format .....	10-31

## 10.1 Communication Function Specifications

### 10.1 Communication Function Specifications

#### 10.1.1 Communication Specifications of the Control Unit

##### ■ USB port (for tool software)

Items	Description
Standard	USB2.0 FULL SPEED
Communication function	MEWTOCOL-COM (slave)

##### ■ COM0 port

Items	Description
Interface	RS-232C (3-wire type)×1ch (non-insulated)
Transmission distance	15 m (Note 1)
Baud rate	1200, 2400, 4800, 9600, 19200, 38400, 57600, 115200, 230400 bit/s
Communication method	Half-duplex transmission
Synchronous method	Start stop synchronous system
Transmission format	Data length: 7 bits / 8 bits; Stop bit: 1 bit / 2 bits; Parity: None / Odd / Even; Header: STX / No STX; Terminator: CR / CR+LF / None / ETX / Time (0 to 100 ms)
Data transmission order	Transmits from bit 0 character by character.
Communication function	PLC link MEWTOCOL-COM (master / slave) MODBUS RTU (master / slave) General-purpose communication Modem initialization

(Note 1) When communication is performed at a baud rate of 38400 bit/s or higher, use a cable not longer than 3 m. When wiring RS-232C, a shielded wire must be used to increase noise suppression.

#### 10.1.2 Communication Cassette Specifications

##### ■ RS-232C / RS-485 interface

Item	Specifications			
	AFP0HCCS1	AFP0HCCS2	AFP0HCCM1	AFP0HCCS1M1
Interface	RS-232C (5-wire type) x 1 channel (Non-isolated) <sup>(Note 1)</sup>	RS-232C (3-wire type) x 2 channels (Non-isolated)	RS-485 x 1 channel (Isolated) <sup>(Note 2)</sup>	RS-485 x 1 channel (Isolated) RS-232C (3-wire type) x 1 channel (Non-isolated) <sup>(Note 2)</sup>

## 10.1 Communication Function Specifications

Item	Specifications			
	AFP0HCCS1	AFP0HCCS2	AFP0HCCM1	AFP0HCCS1M1
Transmission distance	RS-232C: Max. 15 m (Note 3) RS-485: Max. 1200 m (Note 4) (Note 5)			
Baud rate	1200, 2400, 4800, 9600, 19200, 38400, 57600, 115200, 230400 bit/s			
Communication method	Half-duplex transmission			
Synchronous method	Start stop synchronous system			
Communication format	Data length: 7 bits/8 bits, Stop bit: 1 bit/2 bits, Parity: None/Odd/Even, Start code: STX/No STX, End code: CR/CR+LF/None/ETX/Time (0 to 100.00 ms)			
Data transmission order	Transmits from bit 0 character by character.			
Communication function and no. of connected units	PLC Link: Max. 16 units MEWTOCOL-COM (Master/Slave): Max. 99 units MODBUS RTU (Master/Slave): Max. 99 units General-purpose communication: Max. 99 units			

(Note 1) When using it as a 3-wire type, short-circuit the RS-CS terminal.

(Note 2) When connecting a commercially available device that has an RS-485 interface, please confirm operation using the actual device. In some cases, the number of units, transmission distance, and baud rate vary depending on the connected device.

(Note 3) When communication is performed at a baud rate of 38400 bit/s or higher, use the cable not longer than 3 m. For wiring the RS-232C, a shielded wire must be used to increase noise suppression.

(Note 4) The transmission distance is limited by the baud rate and the number of connected units when setting RS-485 as follows. For the baud rate of 38400 bit/s or less, the distance is up to 1200 m, and the number of connected units is 99. When using in combination with the C-NET adapter, the maximum number of connected units is limited to 32, and the baud rate is limited to 19200 bit/s or less.

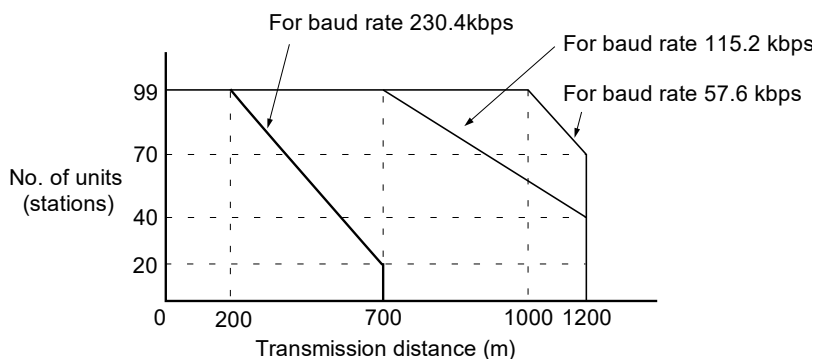

(Note 5) The converter SI-35 manufactured by Lineeye Co., Ltd. is recommendable for the RS-485 at the computer side.

## 10.2 List of System Registers

### 10.2 List of System Registers

#### ■ Memory allocation

No.	Name	Default	Setting range and description
0	Sequence program area size (Note 1) (Note 2)	32	[FP0H mode] C32: 24K, 32K words C32E: 24K, 32K, 40K, 64K words [FPsigma mode] 24K, 32K words
1	Internal relay area size (Note 1)	8192	C32: 4096, 8192 C32E: 8192 (Fixed)

(Note 1) The system register no. 0 (Sequence program area size) and no. 1 (Internal relay area size) can be set only in off-line editing. To make the setting effective, you need to download it to the control unit.

(Note 2) System register no.0: if you change the sequence program area capacity, the capacity of the data register DT will be changed.

For the FPsigma mode, only 24K or 32K words can be selected.

#### ■ Hold / Non-hold 1

No.	Name	Default	Setting range and description
5	Counter starting address	1008	0 to 1024
6	Hold type area starting address for timer/counter	1008	0 to 1024
7	Starting word No. of internal relay hold area (Note 1)	[FP0H mode]	
		248	0 to 256
		504	0 to 512
		[FPsigma mode]	
		248 (Fixed)	0 to 256, 0 to 512
8	Hold type area starting address for data registers (Note 2)	[FP0H mode] C32:	
		32450	0 to 32765
		65218	0 to 65533
		[FP0H mode] C32E:	
		11970	0 to 12285
		24258	0 to 24573
		32450	0 to 32765
65218	0 to 65533		
		[FPsigma mode]	
		32710 (Fixed)	0 to 32765 0 to 65533
14	Holding the step ladder	Non-hold	Hold/Non-hold
4	Leading edge detection of the differential instruction during MC holds the previous value	Hold	Hold/Non-hold



## 10.2 List of System Registers

(Note 1) The default and setting range of System register No. 7 differ depending on the value of System register No.1.

System register No.1	System register No.7		
	Default		Setting range
	FP0H mode	FPsigma mode	
4096 points	248	248 (Fixed)	0 to 256
8192 points	504		0 to 512

(Note 2) The default and setting range of System register No. 8 differ depending on the value of System register No.0.

System register No.0		System register No.8		
		Default		Setting range
		FP0H mode	FPsigma mode	
24Kstep		65218	32710 (Fixed)	0 to 65533
32Kstep		32450		0 to 32765
40Kstep	C32ET only	24258	No setting	0 to 24573
64Kstep		11970		0 to 12285

### ■ Hold / Non-hold 2

No.	Name	Default	Setting range and description
10	Hold type area starting word address setting for link relays for PLC link W0-0	64	0 to 64
11	Hold type area starting word address setting for link relays for PLC link W0-1	128	64 to 128
12	Hold type area starting word address setting for link data registers for PLC link W0-0	128	0 to 128
13	Hold type area starting word address setting for link data registers for PLC link W0-1	256	128 to 256

### ■ Action on Error

No.	Name	Default	Setting range and description
20	Disable settings for duplicated output	Disable	Disable/Enable
23	Stop operation when an I/O verification error occurs	Stop	Stop/Run
24	Stop operation when configuration data error/initialization request error occurs (C32ET/C32EP only)	Stop	Stop/Run
25	Stop operation when positioning operation error occurs	Run	Stop/Run

## 10.2 List of System Registers

No.	Name	Default	Setting range and description
26	Stop operation when calculating error occurs	Stop	Stop/Run
27	Stop operation when network error occurs (C32ET/C32EP only)	Stop	Stop/Run
4	Alarm the battery abnormality	No	No: The self-diagnostic error is not notified in case of battery error, and the "ERR/ALM" LED does not flash. Yes: The self-diagnostic error is notified in case of battery error, and the "ERR/ALM" LED flashes.

### ■ Time setting

No.	Name	Default	Setting range and description
31	Waiting time for managing multiple frame	6500 ms	10 to 81900 ms (In 2.5 ms unit)
32	SEND / RECV / RMRD / RMWT instruction waiting time	10000 ms	10 to 81900 ms (In 2.5 ms unit)
34	Constant scan time	Normal scan	0: Normal scan (in 0.5 ms unit) 0 to 600 ms: Scan at a specified time interval
37	Task time priority setting (Note 1)	Standard	Normal/Operation

(Note 1) It is available only in RUN mode. The setting is always "Normal" in PROG. mode.

By selecting "Operation", the time taken for the communication processing is reduced for one port per scan. The operation processing takes priority.

### ■ PLC link W0-0 setting

No.	Name	Default	Setting range and description
40	Size of link relays	0	0 to 64 words
41	Size of link data registers	0	0 to 128 words
42	Send area starting word address of link relay	0	0 to 63
43	Size of link relays used for send area	0	0 to 64 words
44	Send area starting address of link data register	0	0 to 127
45	Size of link data registers used for send area	0	0 to 127 words
46	PLC link switch flag	Normal	Normal/Reverse
47	MEWNET-W0 PLC link max. station no.	16	1 to 16
48	PLC link baud rate (Note 1)	115200bps	115200 bps/230400 bps

(Note 1) The system register no. 48 (PLC link baud rate) is set in the same dialog box for the COM0 port, COM1 port and COM2 port settings.

### ■ PLC link W0-1 setting

No.	Name	Default	Setting range and description
50	Size of link relays	0	0 to 64 words
51	Size of link data registers	0	0 to 128 words
52	Send area starting word address of link relay	64	64 to 127
53	Size of link relays used for send area	0	0 to 64 words
54	Send area starting address of link data register	128	128 to 255
55	Size of link data registers used for send area	0	0 to 127 words
57	MEWNET-W0 PLC link max. station no.	16	1 to 16

### ■ Controller input settings (HSC/PLS)

No.	Name	Default	Setting range and description
400	HSC operation mode settings (X0 to X2)	CH0: Not Set X0 as High Speed Counter	Not Set X0 as High Speed Counter 2 phase input (X0, X1) 2 phase input (X0, X1) Reset input (X2) Addition input (X0) Addition input (X0) Reset input (X2) Subtraction input (X0) Subtraction input (X0) Reset input (X2) One input (X0, X1) One input (X0, X1) Reset input (X2) Direction distinction (X0, X1) Direction distinction (X0, X1) Reset input (X2) J-point positioning start input of pulse output CH0 (X0)
		CH1: Not Set X1 as High Speed Counter	Not Set X1 as High Speed Counter Addition input (X1) Addition input (X1) Reset input (X2) Subtraction input (X1) Subtraction input (X1) Reset input (X2) J-point positioning start input of pulse output CH1 (X1)
401	HSC operation mode settings (X3 to X5)	CH2: Not Set X3 as High Speed Counter	Not Set X3 as High Speed Counter 2 phase input (X3, X4) 2 phase input (X3, X4) Reset input (X5) Addition input (X3) Addition input (X3) Reset input (X5) Subtraction input (X3) Subtraction input (X3) Reset input (X5) One input (X3, X4) One input (X3, X4) Reset input (X5) Direction distinction (X3, X4)

## 10.2 List of System Registers

No.	Name	Default	Setting range and description
			Direction distinction (X3, X4) Reset input (X5) J-point positioning start input of pulse output CH2 (X3)
		CH3: Not Set X4 as High Speed Counter	Not Set X4 as High Speed Counter Addition input (X4) Addition input (X4) Reset input (X5) Subtraction input (X4) Subtraction input (X4) Reset input (X5) J-point positioning start input of pulse output CH3 (X4)

(Note 1) "J-point positioning start input" for each channel can be selected only when "Table setting mode" is set in the system register no. 407.

### ■ Controller output settings (PLS/PWM) for FP0H mode

No.	Name	Default	Setting range and description
407	Positioning control mode setting	Table setting mode	Table setting mode, FPsigma compatible instruction mode
402 (Note 1) (Note 2)	Pulse/PWM output setting (Y0 to YC) When selecting "Table setting mode" in no. 407	CH0:	Normal output (Y0, Y1) WM output (Y0), Normal output (Y1) Pulse output [Table operation] (Y0, Y1)
		CH1:	Normal output (Y3, Y4) Normal output (Y3, Y4) PWM output (Y3), Normal output (Y4) Pulse output [Table operation] (Y3, Y4)
		CH2:	Normal output (Y8, Y9) Normal output (Y8, Y9) PWM output (Y8), Normal output (Y9) Pulse output [Table operation] (Y8, Y9)
		CH3:	Normal output (YB, YC) Normal output (YB, YC) PWM output (YB), Normal output (YC) Pulse output [Table operation] (YB, YC)
	Pulse/PWM output setting (Y0 to YC) When selecting "FPsigma compatible instruction mode" in no. 407	CH0:	Normal output (Y0, Y1) Normal output (Y0, Y1) Pulse output (Y0, Y1) PWM output (Y0), Normal output (Y1)
		CH1:	Normal output (Y3, Y4) Normal output (Y3, Y4) Pulse output (Y3, Y4) PWM output (Y3), Normal output (Y4)
		CH2:	Normal output (Y8, Y9) Normal output (Y8, Y9) Pulse output (Y8, Y9) PWM output (Y8), Normal output (Y9)
		CH3:	Normal output (YB, YC) Normal output (YB, YC) Pulse output (YB, YC) PWM output (YB), Normal output (YC)

### ■ Controller output settings (PLS/PWM) for FPsigma mode

No.	Name	Default	Setting range and description
407 (Note 1)	Positioning control mode setting	FPsigma compatible instruction mode	FPsigma compatible instruction mode (Fixed)
402	Pulse/PWM output settings (Y0 to YC) (Note 2)	-	Not selectable

(Note 1) If the no. 407 (Positioning control start setting) is changed, the selection of the no. 402 (Pulse/PWM output setting) will be switched.

(Note 2) For using the pulse output [Table setting mode] function, pulse output function and PWM output function, the controller output setting must be set. The output specified for the pulse output and PWM output cannot be used as normal output.

### ■ Interrupt / pulse catch settings

No.	Name	Default	Setting range and description																
403 (Note 1)	Pulse catch input setting	Not set	<table style="margin-left: auto; margin-right: auto;"> <tr> <td style="text-align: center;">X0</td><td style="text-align: center;">X1</td><td style="text-align: center;">X2</td><td style="text-align: center;">X3</td><td style="text-align: center;">X4</td><td style="text-align: center;">X5</td><td style="text-align: center;">X6</td><td style="text-align: center;">X7</td> </tr> <tr> <td colspan="8" style="text-align: center;">Controller input <input type="checkbox"/></td> </tr> </table> <p>The pressed contact is set as pulse catch input.</p>	X0	X1	X2	X3	X4	X5	X6	X7	Controller input <input type="checkbox"/>							
X0	X1	X2	X3	X4	X5	X6	X7												
Controller input <input type="checkbox"/>																			
404 (Note 1)	Interrupt input settings	Not set	<table style="margin-left: auto; margin-right: auto;"> <tr> <td style="text-align: center;">X0</td><td style="text-align: center;">X1</td><td style="text-align: center;">X2</td><td style="text-align: center;">X3</td><td style="text-align: center;">X4</td><td style="text-align: center;">X5</td><td style="text-align: center;">X6</td><td style="text-align: center;">X7</td> </tr> <tr> <td colspan="8" style="text-align: center;">Controller input <input type="checkbox"/></td> </tr> </table> <p>The pressed contact is set as interrupt input.</p>	X0	X1	X2	X3	X4	X5	X6	X7	Controller input <input type="checkbox"/>							
X0	X1	X2	X3	X4	X5	X6	X7												
Controller input <input type="checkbox"/>																			

(Note 1) If the same input is set to the high-speed counter, pulse catch, and interrupt input, the priority order is as follows; 1. High-speed counter, 2. Pulse catch, 3. Interrupt input.

### ■ Interrupt edge setting

No.	Name	Default	Setting range and description																																
405 (Note 1)	Effective interrupt edge setting for controller input	Leading edge	<table style="margin-left: auto; margin-right: auto;"> <tr> <td style="text-align: center;">X0</td><td style="text-align: center;">X1</td><td style="text-align: center;">X2</td><td style="text-align: center;">X3</td><td style="text-align: center;">X4</td><td style="text-align: center;">X5</td><td style="text-align: center;">X6</td><td style="text-align: center;">X7</td> </tr> <tr> <td colspan="8" style="text-align: center;">Leading edge <input type="checkbox"/></td> </tr> <tr> <td style="text-align: center;">X0</td><td style="text-align: center;">X1</td><td style="text-align: center;">X2</td><td style="text-align: center;">X3</td><td style="text-align: center;">X4</td><td style="text-align: center;">X5</td><td style="text-align: center;">X6</td><td style="text-align: center;">X7</td> </tr> <tr> <td colspan="8" style="text-align: center;">Trailing edge <input type="checkbox"/></td> </tr> </table> <p>The pressed contacts are set as leading and trailing edges.</p>	X0	X1	X2	X3	X4	X5	X6	X7	Leading edge <input type="checkbox"/>								X0	X1	X2	X3	X4	X5	X6	X7	Trailing edge <input type="checkbox"/>							
X0	X1	X2	X3	X4	X5	X6	X7																												
Leading edge <input type="checkbox"/>																																			
X0	X1	X2	X3	X4	X5	X6	X7																												
Trailing edge <input type="checkbox"/>																																			

(Note 1) If the same input is set to the high-speed counter, pulse catch, and interrupt input, the priority order is as follows; 1. High-speed counter, 2. Pulse catch, 3. Interrupt input.

### ■ Time constant setting of controller input 1 / 2

No.	Name	Default	Setting range and description
430	Input X0 to X3	[FP0H mode]	None / 0.1 ms / 0.2 ms / 0.5 ms / 1 ms / 2 ms / 4 ms / 8 ms / 16 ms / 32 ms / 64 ms / 128 ms / 256 ms
431	Input X4 to X7	1 ms	
432	Input X8 to XB	[FPsigma mode]	
433	Input XC to XF	None	
438	Update inputs status when the power is turned on (Note 1)	After a time constant	After a time constant Immediately

## 10.2 List of System Registers

(Note 1) Available on FP0H Ver.1.9 or later

### ■ COM0 / COM1 / COM2 port setting

No.	Name	Default	Setting range and description
410 411	Unit No.	1	1 to 99
412	Communication Mode	Computer Link	Computer Link General-purpose communication PLC Link MODBUS RTU
	Modem connection	Not execute	Execute/Not execute
413 414	Communication format	Data length: 8 bits Parity check: Odd Stop bit: 1	Character bit: 7 bits/8 bits Parity: None/Odd/Even Stop bit: 1/2 Terminator selection: Code/Time Terminator: CR/CR+LF/None/ETX Header: STX Not Exist./STX exists
415	Baud rate <sup>(Note 2)(Note 3)(Note 4)</sup>	9600 bps	2400 bps, 4800 bps, 9600 bps, 19200 bps, 38400 bps, 57600 bps, 115200 bps, 230400 bps
416	(COM1) Starting address for data received of serial data communication mode	0	0 to 65532 <sup>(Note 1)</sup>
417	(COM1) Buffer capacity setting for data received of serial data communication mode	2048	0 to 2048
418	(COM2) Starting address for data received of serial data communication mode	2048	0 to 65532 <sup>(Note 1)</sup>
419	(COM2) Buffer capacity setting for data received of serial data communication mode	2048	0 to 2048
420	(COM0) Starting address for data received of serial data communication mode	4096	0 to 65532 <sup>(Note 1)</sup>
421	(COM0) Buffer capacity setting for data received of serial data communication mode	2048	0 to 2048
424	(COM0) Terminator judgement time (x 0.01 ms)	0	0 or 1 to 10000 (0.01 ms to 100 ms) When terminator judgement time is 0, transmission time is that for approx. 4 bytes.
425	(COM1) Terminator judgement time (x 0.01 ms)	0	

No.	Name	Default	Setting range and description
426	(COM2) Terminator judgement time (x 0.01 ms)	0	

(Note 1) The range of the system register no. 416/418/420 varies according to the value of the system register no. 0.

System registerNo.0 Sequence program area size	System register no. 416/418/420/422 Receive buffer starting address in general-purpose communication
24Kstep	0 to 65532
32Kstep	0 to 32764
40Kstep	0 to 24572
64Kstep	0 to 12284

(Note 2) System register no. 415 cannot be used to set the baud rate to 1200 bps. To set the baud rate to 1200 bps, use the SYS1 instruction.

(Note 3) If the baud rate is changed as below, communications passing through all COM ports will be reset.

Baud rates of all COM ports: 4800 bps or higher ↔ Baud rates of any COM ports: 2400 bps or lower

(Note 4) If the baud rate of any of the COM ports is 2400 bps or lower, F-ROM access will slow down.

Example) F12(ICRD) instruction, P13(ICWT) instruction, etc.

### ■ SD card setting (Type with Ethernet function)

No.	Name	Default	Setting range and description
440	SD card cover open/close detection	Detect	Detect/Not detect Detect: When the cover of the control unit is open, accessing the SD memory card is not allowed. Or the access is stopped. Not detect: Even when the cover of the control unit is open, accessing the SD memory card is allowed. However, if an SD memory card is removed/ inserted during the SD memory card access, the SD memory card or data may be damaged.
441	Allowed time of SD card task operation	10 ms	0.5 to 100 ms (In 0.5 ms unit)

### ■ Compatible mode

No.	Name	Default	Setting range and description
3	Compatible mode setting <sup>(Note 1)</sup>	FP0H mode (Note 2)	FP0H mode FPsigma mode

(Note 1) System register no.3 (compatibility mode settings) can be set only in off-line editing. To make the setting effective, you need to download it to the control unit.

(Note 2) If the PLC has been changed from FPsigma to another model, FPsigma mode is used by default.

## 10.3 List of Special Relays (COM Communication)

### 10.3 List of Special Relays (COM Communication)

Only special relays related to communication by COM0 port of the main control unit and by COM port of a communication cassette are listed below.

#### WR900 (specification in word units)

Relay No.	Name	Description
R900E (R9130)	COM0 port communication error	Turns ON when a communication error is detected during the use of COM0 port

(Note 1) The same function is also allocated to the special internal relay indicated in brackets.

#### WR903 (specification in word units)

Relay No.	Name	Description
R9030 to R9031	Reserved for system	-
R9032 (R9139)	COM1 port communication mode flag	Turns ON when the general-purpose communication function is used. Turns OFF when functions other than general-purpose communication are used.
R9033	Print instruction execution flag	OFF: Instruction not active ON: Instruction in progress
R9034	Program edit flag during RUN mode	A special internal relay that only turns on the first single scan following the completion of rewriting during RUN.
R9035 to R9036	Reserved for system	-
R9037 (R9138)	COM1 port communication error flag	Turns ON when a transmission error occurs during data communication. Turns OFF when transmission is requested using an F159 (MTRN) instruction.
R9038 (R913A)	COM1 port reception done flag during general-purpose communication	Turns ON when the terminator (end code) is received during general-purpose communication Turns OFF when transmission is requested during general-purpose communication.
R9039 (R913B)	COM1 port transmission done flag during general-purpose communication	Turns ON when transmission is done during general-purpose communication. Turns OFF when transmission is requested during general-purpose communication.
R903A to R903D	Reserved for system	-
R903E (R9132)	COM0 port reception done flag during general-purpose communication	Turns ON when the terminator (end code) is received during general-purpose communication Turns OFF when transmission is requested during general-purpose communication.
R903F (R9133)	COM0 port transmission done flag during general-purpose communication	Turns ON when transmission is done during general-purpose communication. Turns OFF when transmission is requested during general-purpose communication.



## 10.3 List of Special Relays (COM Communication)

(Note 1) R9030 to R903F changes even while a scan is in progress. The same function is also allocated to the special internal relay indicated in brackets.

### WR904 (specification in word units)

Relay No.	Name	Description
R9040 (R9131)	COM0 port communication mode flag	Turns ON when the general-purpose communication function is used. Turns OFF when functions other than general-purpose communication are used.
R9041 (R913E)	COM1 port PLC link flag	Turns ON when the PLC link function is used.
R9042 (R9141)	COM2 port communication mode flag	Turns ON when the general-purpose communication function is used. Turns OFF when functions other than general-purpose communication are used.
R9043	Reserved for system	-
R9044 (R913C)	COM1 port SEND/RECV instruction execution flag	Indicates the executability of F145 (SEND) or F146 (RECV) instruction to COM1 port. OFF: Not executable (execution in progress) ON: Executable
R9045 (R913D)	COM1 port SEND/RECV instruction execution end flag	Indicates the state of execution of F145 (SEND) or F146 (RECV) instruction to COM1 port. OFF: Successful ON: Unsuccessful (communication error has occurred) Error codes are stored in DT90124.
R9046	Reserved for system	-
R9047 (R9140)	COM2 port communication error flag	Turns ON when a transmission error occurs during data communication. Turns OFF when transmission is requested using an F159 (MTRN) instruction.
R9048 (R9142)	COM2 port reception done flag during general-purpose communication	Turns ON when the terminator (end code) is received during general-purpose communication Turns OFF when transmission is requested during general-purpose communication.
R9049 (R9143)	COM2 port transmission done flag during general-purpose communication	Turns ON when transmission is done during general-purpose communication. Turns OFF when transmission is requested during general-purpose communication.
R904A (R9144)	COM2 port SEND/RECV instruction execution flag	Indicates the executability of F145 (SEND) or F146 (RECV) instruction to COM2 port. OFF: Not executable (execution in progress) ON: Executable
R904B (R9145)	COM2 port SEND/RECV instruction execution end flag	Indicates the state of execution of F145 (SEND) or F146 (RECV) instruction to COM2 port. OFF: Successful ON: Unsuccessful (communication error has occurred) Error codes are stored in DT90125.
R904C to R904F	Reserved for system	-

## 10.3 List of Special Relays (COM Communication)

(Note 1) R9040 to R904F changes even while a scan is in progress. The same function is also allocated to the special internal relay indicated in brackets.

### WR905 (specification in word units)

Relay No.	Name	Description
R9050	MEWNET-W0 PLC link transmission error flag	Turns ON when transmission error occurs in PLC link during the use of MEWNET-W0. Turns ON when there is an error in the setting for the PLC link area.
R9051 to R905F	Reserved for system	-

### WR906 (specification in word units)

Relay No.	Name	Description
R9060	MEWNET-W0 PLC link 0 transmission assurance relay	Unit No.1 When Unit No.1 is normally communicating in PLC link mode: ON When the unit is stopped, an error has occurred, or PLC link is not established: OFF
R9061		Unit No.2 When Unit No.2 is normally communicating in PLC link mode: ON When the unit is stopped, an error has occurred, or PLC link is not established: OFF
R9062		Unit No.3 When Unit No.3 is normally communicating in PLC link mode: ON When the unit is stopped, an error has occurred, or PLC link is not established: OFF
R9063		Unit No.4 When Unit No.4 is normally communicating in PLC link mode: ON When the unit is stopped, an error has occurred, or PLC link is not established: OFF
R9064		Unit No.5 When Unit No.5 is normally communicating in PLC link mode: ON When the unit is stopped, an error has occurred, or PLC link is not established: OFF
R9065		Unit No.6 When Unit No.6 is normally communicating in PLC link mode: ON When the unit is stopped, an error has occurred, or PLC link is not established: OFF
R9066		Unit No.7 When Unit No.7 is normally communicating in PLC link mode: ON When the unit is stopped, an error has occurred, or PLC link is not established: OFF
R9067		Unit No.8 When Unit No.8 is normally communicating in PLC link mode: ON When the unit is stopped, an error has occurred, or PLC link is not established: OFF
R9068		Unit No.9 When Unit No.9 is normally communicating in PLC link mode: ON

## 10.3 List of Special Relays (COM Communication)

Relay No.	Name	Description
		When the unit is stopped, an error has occurred, or PLC link is not established: OFF
R9069		Unit No.10 When Unit No.10 is normally communicating in PLC link mode: ON When the unit is stopped, an error has occurred, or PLC link is not established: OFF
R906A		Unit No.11 When Unit No.11 is normally communicating in PLC link mode: ON When the unit is stopped, an error has occurred, or PLC link is not established: OFF
R906B		Unit No.12 When Unit No.12 is normally communicating in PLC link mode: ON When the unit is stopped, an error has occurred, or PLC link is not established: OFF
R906C		Unit No.13 When Unit No.13 is normally communicating in PLC link mode: ON When the unit is stopped, an error has occurred, or PLC link is not established: OFF
R906D		Unit No.14 When Unit No.14 is normally communicating in PLC link mode: ON When the unit is stopped, an error has occurred, or PLC link is not established: OFF
R906E		Unit No.15 When Unit No.15 is normally communicating in PLC link mode: ON When the unit is stopped, an error has occurred, or PLC link is not established: OFF
R906F		Unit No.16 When Unit No.16 is normally communicating in PLC link mode: ON When the unit is stopped, an error has occurred, or PLC link is not established: OFF

### WR907 (specification in word units)

Relay No.	Name	Description
R9070	MEWNET-W0 PLC link 0 operation mode relay	Unit No.1 Turns ON when Unit No.1 is in RUN mode. Turns OFF in PROG. mode.
R9071		Unit No.2 Turns ON when Unit No.2 is in RUN mode. Turns OFF in PROG. mode.
R9072		Unit No.3 Turns ON when Unit No.3 is in RUN mode. Turns OFF in PROG. mode.
R9073		Unit No.4 Turns ON when Unit No.4 is in RUN mode. Turns OFF in PROG. mode.
R9074		Unit No.5 Turns ON when Unit No.5 is in RUN mode. Turns OFF in PROG. mode.
R9075		Unit No.6 Turns ON when Unit No.6 is in RUN mode. Turns OFF in PROG. mode.
R9076		Unit No.7 Turns ON when Unit No.7 is in RUN mode.

## 10.3 List of Special Relays (COM Communication)

Relay No.	Name	Description
		Turns OFF in PROG. mode.
R9077		Unit No.8 Turns ON when Unit No.8 is in RUN mode. Turns OFF in PROG. mode.
R9078		Unit No.9 Turns ON when Unit No.9 is in RUN mode. Turns OFF in PROG. mode.
R9079		Unit No.10 Turns ON when Unit No.10 is in RUN mode. Turns OFF in PROG. mode.
R907A		Unit No.11 Turns ON when Unit No.11 is in RUN mode. Turns OFF in PROG. mode.
R907B		Unit No.12 Turns ON when Unit No.12 is in RUN mode. Turns OFF in PROG. mode.
R907C		Unit No.13 Turns ON when Unit No.13 is in RUN mode. Turns OFF in PROG. mode.
R907D		Unit No.14 Turns ON when Unit No.14 is in RUN mode. Turns OFF in PROG. mode.
R907E		Unit No.15 Turns ON when Unit No.15 is in RUN mode. Turns OFF in PROG. mode.
R907F		Unit No.16 Turns ON when Unit No.16 is in RUN mode. Turns OFF in PROG. mode.

### WR908 (specification in word units)

Relay No.	Name	Description
R9080		Unit No.1 When Unit No.1 is normally communicating in PLC link mode: ON When the unit is stopped, an error has occurred, or PLC link is not established: OFF
R9081		Unit No.2 When Unit No.2 is normally communicating in PLC link mode: ON When the unit is stopped, an error has occurred, or PLC link is not established: OFF
R9082	MEWNET-W0 PLC link 1 transmission assurance relay	Unit No.3 When Unit No.3 is normally communicating in PLC link mode: ON When the unit is stopped, an error has occurred, or PLC link is not established: OFF
R9083		Unit No.4 When Unit No.4 is normally communicating in PLC link mode: ON When the unit is stopped, an error has occurred, or PLC link is not established: OFF
R9084		Unit No.5 When Unit No.5 is normally communicating in PLC link mode: ON When the unit is stopped, an error has occurred, or PLC link is not established: OFF
R9085		Unit No.6 When Unit No.6 is normally communicating in PLC link mode: ON

## 10.3 List of Special Relays (COM Communication)

Relay No.	Name	Description
		When the unit is stopped, an error has occurred, or PLC link is not established: OFF
R9086	Unit No.7	When Unit No.7 is normally communicating in PLC link mode: ON When the unit is stopped, an error has occurred, or PLC link is not established: OFF
R9087	Unit No.8	When Unit No.8 is normally communicating in PLC link mode: ON When the unit is stopped, an error has occurred, or PLC link is not established: OFF
R9088	Unit No.9	When Unit No.9 is normally communicating in PLC link mode: ON When the unit is stopped, an error has occurred, or PLC link is not established: OFF
R9089	Unit No.10	When Unit No.10 is normally communicating in PLC link mode: ON When the unit is stopped, an error has occurred, or PLC link is not established: OFF
R908A	Unit No.11	When Unit No.11 is normally communicating in PLC link mode: ON When the unit is stopped, an error has occurred, or PLC link is not established: OFF
R908B	Unit No.12	When Unit No.12 is normally communicating in PLC link mode: ON When the unit is stopped, an error has occurred, or PLC link is not established: OFF
R908C	Unit No.13	When Unit No.13 is normally communicating in PLC link mode: ON When the unit is stopped, an error has occurred, or PLC link is not established: OFF
R908D	Unit No.14	When Unit No.14 is normally communicating in PLC link mode: ON When the unit is stopped, an error has occurred, or PLC link is not established: OFF
R908E	Unit No.15	When Unit No.15 is normally communicating in PLC link mode: ON When the unit is stopped, an error has occurred, or PLC link is not established: OFF
R908F	Unit No.16	When Unit No.16 is normally communicating in PLC link mode: ON When the unit is stopped, an error has occurred, or PLC link is not established: OFF

### WR909 (specification in word units)

Relay No.	Name	Description
R9090	MEWNET-W0 PLC link 1	Unit No.1 Turns ON when Unit No.1 is in RUN mode. Turns OFF in PROG. mode.

## 10.3 List of Special Relays (COM Communication)

Relay No.	Name	Description
R9091	operation mode relay	Unit No.2 Turns ON when Unit No.2 is in RUN mode. Turns OFF in PROG. mode.
R9092		Unit No.3 Turns ON when Unit No.3 is in RUN mode. Turns OFF in PROG. mode.
R9093		Unit No.4 Turns ON when Unit No.4 is in RUN mode. Turns OFF in PROG. mode.
R9094		Unit No.5 Turns ON when Unit No.5 is in RUN mode. Turns OFF in PROG. mode.
R9095		Unit No.6 Turns ON when Unit No.6 is in RUN mode. Turns OFF in PROG. mode.
R9096		Unit No.7 Turns ON when Unit No.7 is in RUN mode. Turns OFF in PROG. mode.
R9097		Unit No.8 Turns ON when Unit No.8 is in RUN mode. Turns OFF in PROG. mode.
R9098		Unit No.9 Turns ON when Unit No.9 is in RUN mode. Turns OFF in PROG. mode.
R9099		Unit No.10 Turns ON when Unit No.10 is in RUN mode. Turns OFF in PROG. mode.
R909A		Unit No.11 Turns ON when Unit No.11 is in RUN mode. Turns OFF in PROG. mode.
R909B		Unit No.12 Turns ON when Unit No.12 is in RUN mode. Turns OFF in PROG. mode.
R909C		Unit No.13 Turns ON when Unit No.13 is in RUN mode. Turns OFF in PROG. mode.
R909D		Unit No.14 Turns ON when Unit No.14 is in RUN mode. Turns OFF in PROG. mode.
R909E		Unit No.15 Turns ON when Unit No.15 is in RUN mode. Turns OFF in PROG. mode.
R909F		Unit No.16 Turns ON when Unit No.16 is in RUN mode. Turns OFF in PROG. mode.

### WR913 (specification in word units)

Relay No.	Name	Description
R9130 (R900E)	COM0 port communication error flag	Turns ON when a transmission error occurs during data communication. Turns OFF when transmission is requested using an F159 (MTRN) instruction.
R9131 (R9040)	COM0 port communication mode flag	Turns ON when the general-purpose communication function is used. Turns OFF when functions other than general-purpose communication are used.
R9132 (R903E)	COM0 port transmission done flag during general-purpose communication	Turns ON when the terminator (end code) is received during general-purpose communication

## 10.3 List of Special Relays (COM Communication)

Relay No.	Name	Description
R9133 (R903F)	COM0 port transmission done flag during general-purpose communication	Turns ON when transmission is done during general-purpose communication. Turns OFF when transmission is requested during general-purpose communication.
R9134	COM0 port SEND/RECV instruction execution flag	Indicates the executability of F145 (SEND) or F146 (RECV) instruction to COM0 port. OFF: Not executable (execution in progress) ON: Executable
R9135	COM0 port SEND/RECV instruction execution end flag	Indicates the state of execution of F145 (SEND) or F146 (RECV) instruction to COM0 port. OFF: Successful ON: Unsuccessful (communication error has occurred) Error codes are stored in DT90123.
R9136	COM0 port PLC link flag	Turns ON when the PLC link function is used.
R9137	Reserved for system	-
R9138 (R9037)	COM1 port communication error flag	Turns ON when a transmission error occurs during data communication. Turns OFF when transmission is requested using an F159 (MTRN) instruction.
R9139 (R9032)	COM1 port communication mode flag	Turns ON when the general-purpose communication function is used. Turns OFF when functions other than general-purpose communication are used.
R913A (R9038)	COM1 port reception done flag during general-purpose communication	Turns ON when the terminator (end code) is received during general-purpose communication
R913B (R9039)	COM1 port transmission done flag during general-purpose communication	Turns ON when transmission is done during general-purpose communication. Turns OFF when transmission is requested during general-purpose communication.
R913C (R9044)	COM1 port SEND/RECV instruction execution flag	Indicates the executability of F145 (SEND) or F146 (RECV) instruction to COM1 port. OFF: Not executable (execution in progress) ON: Executable
R913D (R9045)	COM1 port SEND/RECV instruction execution end flag	Indicates the state of execution of F145 (SEND) or F146 (RECV) instruction to COM1 port. OFF: Successful ON: Unsuccessful (communication error has occurred) Error codes are stored in DT90124.
R913E (R9041)	COM1 port PLC link flag	Turns ON when the PLC link function is used.
R913F	Reserved for system	-

(Note 1) R9130 to R913F changes even while a scan is in progress. To maintain compatibility with the existing FPsigma control unit, the same function is also allocated to the special internal relay indicated in brackets.

## 10.3 List of Special Relays (COM Communication)

### WR914 (specification in word units)

Relay No.	Name	Description
R9140 (R9047)	COM2 port communication error flag	Turns ON when a transmission error occurs during data communication. Turns OFF when transmission is requested using an F159 (MTRN) instruction.
R9141 (R9042)	COM2 port communication mode flag	Turns ON when the general-purpose communication function is used. Turns OFF when functions other than general-purpose communication are used.
R9142 (R9048)	COM2 port reception done flag during general-purpose communication	Turns ON when the terminator (end code) is received during general-purpose communication
R9143 (R9049)	COM2 port transmission done flag during general-purpose communication	Turns ON when transmission is done during general-purpose communication. Turns OFF when transmission is requested during general-purpose communication.
R9144 (R904A)	COM2 port SEND/RECV instruction execution flag	Indicates the executability of F145 (SEND) or F146 (RECV) instruction to COM2 port. OFF: Not executable (execution in progress) ON: Executable
R9145 (R904B)	COM2 port SEND/RECV instruction execution end flag	Indicates the state of execution of F145 (SEND) or F146 (RECV) instruction to COM2 port. OFF: Successful ON: Unsuccessful (communication error has occurred) Error codes are stored in DT90125.
R9146 to R914F	Reserved for system	-

(Note 1) R9140 to R914F changes even while a scan is in progress. To maintain compatibility with the existing FPsigma control unit, the same function is also allocated to the special internal relay indicated in brackets.





## 10.4 List of Special Data Registers (COM Communication)

Register No.	Name	Description	R	W
DT90140	MEWNET-W0 PLC link 0 status	Number of receptions of PLC link 0	•	
DT90141		PLC link 0 reception interval (current value) (x 2.5 ms)		
DT90142		PLC link 0 reception interval (min. value) (x 2.5 ms)		
DT90143		PLC link 0 reception interval (max. value) (x 2.5 ms)		
DT90144		Number of transmission of PLC link 0		
DT90145		PLC link 0 transmission interval (current value) (x 2.5 ms)		
DT90146		PLC link 0 transmission interval (min. value) (x 2.5 ms)		
DT90147		PLC link 0 transmission interval (max. value) (x 2.5 ms)		
DT90148	MEWNET-W0 PLC link 1 status	Number of receptions of PLC link 1	•	
DT90149		PLC link 1 reception interval (current value) (x 2.5 ms)		
DT90150		PLC link 1 reception interval (min. value) (x 2.5 ms)		
DT90151		PLC link 1 reception interval (max. value) (x 2.5 ms)		
DT90152		Number of transmission of PLC link 0		
DT90153		PLC link 1 transmission interval (current value) (x 2.5 ms)		
DT90154		PLC link 1 transmission interval (min. value) (x 2.5 ms)		
DT90155		PLC link 1 transmission interval (max. value) (x 2.5 ms)		
DT90156	MEWNET-W0	PLC link 0 work for measuring reception interval	•	
DT90157	PLC link 0 status	PLC link 0 work for measuring transmission interval		
DT90158	MEWNET-W0	PLC link 1 work for measuring reception interval	•	
DT90159	PLC link 1 status	PLC link 1 work for measuring transmission interval		
DT90160	MEWNET-W0 PLC link 0 unit number	PLC link 0 unit number is stored.	•	
DT90161	MEWNET-W0 PLC link 0 error flag	The content of error of PLC link 0 is stored.	•	
DT90162 to DT90169	Reserved for system	-		
DT90170	MEWNET-W0 PLC link 0 status	PLC link address duplicate destination	•	
DT90171		No. of missing tokens		
DT90172		No. of duplicate tokens		
DT90173		No. of no signal states		
DT90174		No. of receptions of undefined commands		
DT90175		No. of sum check errors for reception		
DT90176		No. of receive data format errors		

## 10.4 List of Special Data Registers (COM Communication)

Register No.	Name	Description	R	W
DT90177		No. of transmission errors		
DT90178		No. of procedure errors		
DT90179		No. of duplicate master units		
DT90180 to DT90218	Reserved for system	-		

Register No.	Name	Description	R	W
DT90219	Unit No. switch from DT90220 to DT90251	0: Unit Nos. 1 to 8; 1: Unit Nos. 9 to 16	•	
DT90220	PLC link unit no. 1 or 9	System registers 40 and 41		
DT90221		System registers 42 and 43		
DT90222		System registers 44 and 45		
DT90223		System registers 46 and 47		
DT90224	PLC link unit no. 2 or 10	System registers 40 and 41		
DT90225		System registers 42 and 43		
DT90226		System registers 44 and 45		
DT90227		System registers 46 and 47		
DT90228	PLC link unit no. 3 or 11	System registers 40 and 41		
DT90229		System registers 42 and 43		
DT90230		System registers 44 and 45		
DT90231		System registers 46 and 47		
DT90232	PLC link unit no. 4 or 12	System registers 40 and 41		

System register settings related to the PLC link function of each unit number are stored as below.

< Example >  
DT90219 is 0

DT90220~DT90223 (Unit No. 1)

Higher byte      Lower byte

Settings for System registers 40, 42, 44 and 46

Settings for System registers 41, 43, 45 and 47

When standard settings are applied to System register 46 of a master unit, the values of the master unit are copied to 46 and 47 on the left.

When reverse settings are applied to System register 46 of a master unit, 40 to 45 and 47 (portion that corresponds to the master unit on the left) are applied to 50 to 55 and 57, and 46 is directly specified.

Received values are corrected and applied to 40 to 45 (portion that corresponds to another unit), while 46 and 57 of the master unit are applied to 46 and 47.

## 10.4 List of Special Data Registers (COM Communication)

Register No.	Name	Description	R	W
DT90233		System registers 42 and 43		
DT90234		System registers 44 and 45		
DT90235		System registers 46 and 47		

Register No.	Name	Description	R	W
DT90236	PLC link unit no. 5 or 13	System registers 40 and 41		
DT90237		System registers 42 and 43		
DT90238		System registers 44 and 45		
DT90239		System registers 46 and 47		
DT90240	PLC link unit no. 6 or 14	System registers 40 and 41	<p>System register settings related to the PLC link function of each unit number are stored as below.</p> <p>&lt; Example &gt; DT90219 is 0</p>	
DT90241		System registers 42 and 43		
DT90242		System registers 44 and 45		
DT90243		System registers 46 and 47		
DT90244		System registers 40 and 41		
DT90245	PLC link unit no. 7 or 15	System registers 42 and 43	<p>When standard settings are applied to System register 46 of a master unit, the values of the master unit are copied to 46 and 47 on the left.</p> <p>When reverse settings are applied to System register 46 of a master unit, 40 to 45 and 47 (portion that corresponds to the master unit on the left) are applied to 50 to 55 and 57, and 46 is directly specified.</p> <p>Received values are corrected and applied to 40 to 45 (portion that corresponds to another unit), while 46 and 57 of the master unit are applied to 46 and 47.</p>	
DT90246		System registers 44 and 45		
DT90247		System registers 46 and 47		
DT90248	PLC link unit no. 8 or 16	System registers 40 and 41		

## 10.4 List of Special Data Registers (COM Communication)

Register No.	Name	Description	R	W
DT90249		System registers 42 and 43		
DT90250		System registers 44 and 45		
DT90251		System registers 46 and 47		
DT90252 to DT9029	Reserved for system	-		
DT90890	Slot number	The slot number specified for the F469 (UNITSEL) instruction is stored. Built-in serial port: K0, built-in Ethernet port: K100(64h)	•	•
DT90891	Channel number	The channel number specified for the F469 (UNITSEL) instruction is stored. Built-in serial port: K0 to K2 (COM0 to COM2) Built-in Ethernet port: K1 to K9 (user connections 1 to 9)	•	•

## 10.5 Error Codes Table

### 10.5 Error Codes Table

#### 10.5.1 List of MEWTOCOL-COM/DAT Communication Error Codes

Code	Name	Description of error
!26	Abnormal unit number setting	A command was received that cannot be used globally (station number FF).
!40	BCC error	A transmission error has occurred in the received data.
!41	Format error	A command was received that does not match the format.
!42	No support error	An unsupported command was received.
!43	Multiple frames procedure error	Another command was received while multiple frame processing was in progress.
!60	Parameter error	The specified parameter content does not exist or cannot be used.
!61	Data error	There are errors in contact, data area, specification of data No., size specification, range, or format specification.
!62	Registration over error	The number of registrations has been exceeded or the unit has been operated in an unregistered state.
!63	PC mode error	A command that cannot be processed was executed in "RUN mode" or while SD memory card copy was in progress.
!64	Defective external memory error	The hardware is defective. It is likely an abnormality in the built-in ROM (F-ROM). The specified content exceeded the capacity during ROM transfer. A reading/writing error has occurred.
!65	Protect error	A program or system register write operation was executed while the device was in the protected state (password set).
!66	Address error	There is an error in the address data code format, or if the address data was excessive or insufficient, there was an error in the range setting.
!67	No program error and No data error	Message read and sampling trace start/read was executed on unregistered data.
!68	Cannot write during RUN error	While RUN was in progress, an attempt was made to edit an instruction that cannot be rewritten (ED, SUB, RET, INT, IRET, SSTP, STPE). Nothing can be written to the control unit.
!71	Exclusive access control error	A command was executed that cannot be processed at the same time as the command in progress.
!78	No SD card error	No SD card is installed.
!80	Abnormal guarantee data error	The guarantee data (CRC code) is abnormal.
!81	No valid data error	No valid data exists.
!90	Error during logging trace	A command was executed that cannot be processed during logging trace.
!92	Unsupported SD card error	The SD card is not an industrial SD card made by Panasonic.
!93	Invalid server error	A command was executed when the target server was invalid.
!94	Certificate write error	Certificate write was executed using an incorrect procedure.
!97	Server connected error	A command was executed when the target server was connected.

**10.5.2 List of MODBUS Communication Error Codes**

■ **Error code details**

1. Function code error
2. Device number error (out of range)
3. Device quantity error (out of range)

**10.6 MEWTOCOL-COM Format**

**10.6.1 MEWTOCOL-COM Command Type**

■ **Command message**

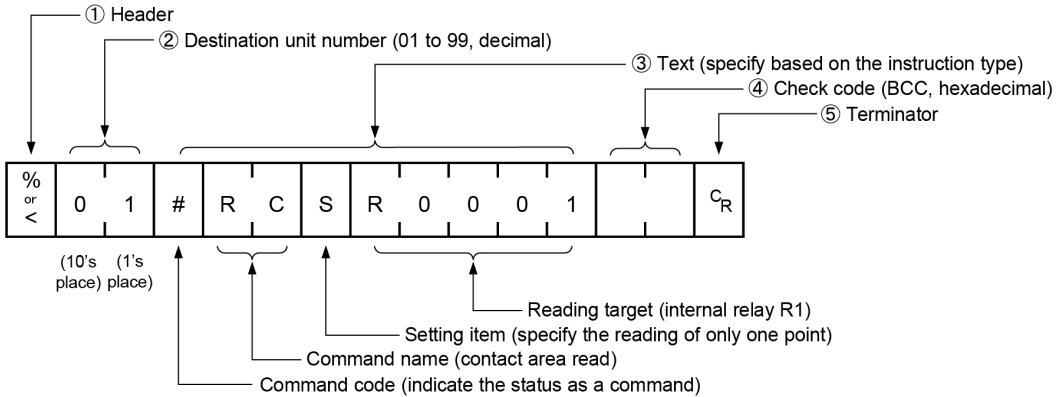

**(1) Header (start code)**

- Commands must always have a “%” (ASCII code: H25) or a “<” (ASCII code: H3C) at the beginning of a message.

**i Info.**

- An expansion header “<” is supported to send a single frame of up to 2048 characters, as well as general “%”.

Type of header	No. of characters that can be sent in 1 frame
%	Max. 118 characters
<	Max. 2048 characters

**(2) Unit number**

- The unit No. of PLC to which you want to send a command should be specified. The unit number of PLC is specified by the system register.
- In 1:1 communication, the unit number “EE” (ASCII code: H4545) can be specified.

**i Info.**

- When the PLC receives a command with “EE” specified for the unit number returns a response regardless of the unit number setting.  
If “EE” is specified in the 1:1 communication, communication can be performed regardless of the unit number setting of the partner PLC.

**(3) Text**

- The content varies depending on the type of instruction. The content should be noted in all upper-case characters, in accordance with the specified format.



**(4) Check code**

- This is a BCC (block check code) for error detection using horizontal parity. The BCC should be created so that it targets all of the text data from the header (start code) to the last text character.
- BCC starts from the header and checks each character in sequence, using the exclusive OR operation, and replaces the final result with character text (ASCII code). It is normally created automatically through calculation program.
- BCC can be skipped by entering “\* \*” (ASCII code: H2A2A) in place of BCC.

**(5) Terminator (end code)**

- Messages must always end with a “CR” (ASCII code: H0D).

**!**

- The method for writing text segments in a message varies depending on the type of command.
- If there are a large number of characters in a message to be sent, divide and send them in several commands.
- If there are a large number of characters in a message, they are divided into several responses.

**10.6.2 MEWTOCOL-COM Response Format**

■ **Response message**

The PLC that received the command returns the processing result.

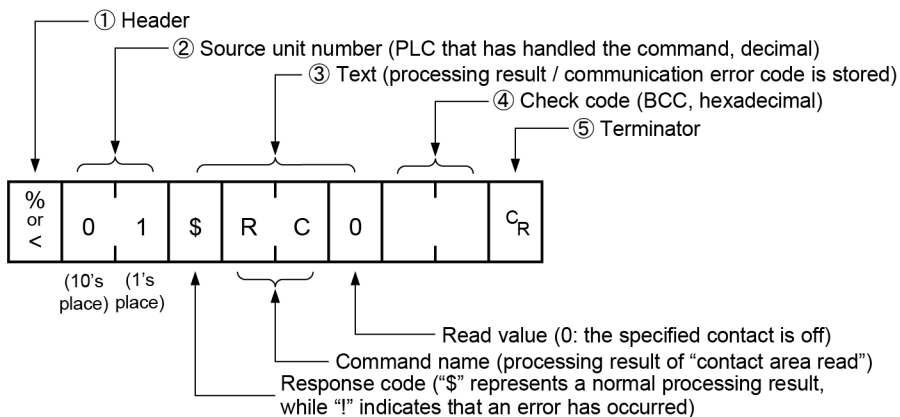

**(1) Header (start code)**

- Commands must always have a “%” (ASCII code: H25) or a “<” (ASCII code: H3C) at the beginning of a message.
- The response must start with the same header that was at the beginning of the command.

**(2) Unit number**

- The unit number of the PLC that processed the command

**(3) Text**

- The content varies depending on the type of instruction. If the processing is not completed successfully, an error code will be stored here, so that the content of the error can be checked.

## 10.6 MEWTOCOL-COM Format

---

### (4) Check code

- This is a BCC (block check code) for error detection using horizontal parity.
- BCC starts from the header and checks each character in sequence, using the exclusive OR operation, and replaces the final result with character text.

### (5) Terminator (end code)

- Messages must always end with a "CR" (ASCII code: H0D).

- If no response is returned, the transmission format may not be correct, the command may not have arrived at the PLC, or the PLC may not be functioning. Check to make sure all of the communication specifications (e.g. baud rate, data length, parity) are aligned.
- If the response contains an "!" instead of a "\$", the command was not processed successfully. The response will contain a communication error code. Check the meaning of the error code.
- Unit number and command name are always identical in a command and its corresponding response, as indicated below. This makes correspondence between a command and a response clear.

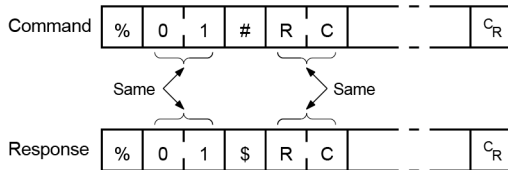

## 10.7 MODBUS RTU Format

### 10.7.1 MODBUS RTU Command Format

#### ■ MODBUS RTU command format

START	ADDRESS	FUNCTION	DATA	CRC CHECK	END
3.5-Character time	8 bits	8 bits	n*8 bits	16 bits	3.5-Character time

ADDRESS (Unit No.): 8 bits, 0 to 247 (decimal)  
Note) 0 = Broadcast address

FUNCTION: 8 bits

DATA: Varies depending on commands.

CRC: 16 bits

END: 3.5-character time (Varies by baud rate. Refer to reception judgment time.)

#### ■ Reception judgment time

The process for receiving a message completes when the time that is exceeding the time mentioned below has passed after the final data was received. Reception done judgment time is time for approx. 32 bits.

Baud rate	Reception done judgment time
1200	Approx. 26.7 ms
2400	Approx. 13.3 ms
4800	Approx. 6.7 ms
9600	Approx. 3.3 ms
19200	Approx. 1.7 ms
38400	Approx. 0.8 ms
57600	Approx. 0.6 ms
115200	Approx. 0.3 ms
230400	Approx. 0.14 ms

### 10.7.2 MODBUS RTU Response Format

#### ■ Response in normal status

- The same message as a command is returned for a single write command or for a loop back test.
- A part of a command message (6 bytes from the beginning) is returned for multiple write command.

## 10.7 MODBUS RTU Format

---

### ■ Response in abnormal status

In case a parameter disabled to be processed is found in a command (except transmission error)

Slave address (Unit No.)	1, 2, or 3
Function code + 80H	
Error code	
CRC	

### ■ Error code contents

- |   |
|---|
| <ol style="list-style-type: none"><li>1. Function code error</li><li>2. Device No. error (outside the range)</li><li>3. Device quantity error (outside the range)</li></ol> |
|---|

## Record of Changes

Manual number can be found at the bottom of the cover page.

Date	Manual No.	Record of Changes
Sep. 2017	WUME-FP0HCOM-01	1st Edition
Nov. 2017	WUME-FP0HCOM-02	2nd Edition Version upgrade of the unit firmware (Ver. 1.1) <ul style="list-style-type: none"> <li>COM port numbers can be specified with a combination of the F469 (UNITSEL) instruction and F145 (SEND) / F146 (RECV) / F159 (MTRN) instructions.</li> </ul>
Jun. 2018	WUME-FP0HCOM-03	3rd Edition Version upgrade of the unit firmware (Ver. 1.2) <ul style="list-style-type: none"> <li>Baud rates (1200 and 2400 bps) added</li> <li>SYS1 instruction added to instruction references</li> </ul>
Nov. 2019	WUME-FP0HCOM-04	4th Edition Changed formatting Amended errors
Jun. 2021	WUME-FP0HCOM-05	5th Edition Version upgrade of the unit firmware (Ver. 1.8) <ul style="list-style-type: none"> <li>Add MEWTOCOL master communication destination unit specification</li> </ul> Amended errors
May 2022	WUME-FP0HCOM-06	6th Edition <ul style="list-style-type: none"> <li>Added information about the MEWTOCOL-COM command and 1:1 communication.</li> </ul>
Apr. 2024	WUME-FP0HCOM-07	7th Edition Change in Corporate name

## Order Placement Recommendations and Considerations

The Products and Specifications listed in this document are subject to change (including specifications, manufacturing facility and discontinuing the Products) as occasioned by the improvements of Products. Consequently, when you place orders for these Products, Panasonic Industry Co., Ltd. asks you to contact one of our customer service representatives and check that the details listed in the document are commensurate with the most up-to-date information.

### [Safety precautions]

Panasonic Industry Co., Ltd. is consistently striving to improve quality and reliability. However, the fact remains that electrical components and devices generally cause failures at a given statistical probability. Furthermore, their durability varies with use environments or use conditions. In this respect, check for actual electrical components and devices under actual conditions before use. Continued usage in a state of degraded condition may cause the deteriorated insulation. Thus, it may result in abnormal heat, smoke or fire. Carry out safety design and periodic maintenance including redundancy design, design for fire spread prevention, and design for malfunction prevention so that no accidents resulting in injury or death, fire accidents, or social damage will be caused as a result of failure of the Products or ending life of the Products.

The Products are designed and manufactured for the industrial indoor environment use. Make sure standards, laws and regulations in case the Products are incorporated to machinery, system, apparatus, and so forth. With regard to the mentioned above, confirm the conformity of the Products by yourself.

Do not use the Products for the application which breakdown or malfunction of Products may cause damage to the body or property.

- i) usage intended to protect the body and ensure security of life
- ii) application which the performance degradation or quality problems, such as breakdown, of the Products may directly result in damage to the body or property

It is not allowed the use of Products by incorporating into machinery and systems indicated below because the conformity, performance, and quality of Products are not guaranteed under such usage.

- i) transport machinery (cars, trains, boats and ships, etc.)
- ii) control equipment for transportation
- iii) disaster-prevention equipment / security equipment
- iv) control equipment for electric power generation
- v) nuclear control system
- vi) aircraft equipment, aerospace equipment, and submarine repeater
- vii) burning appliances
- viii) military devices
- ix) medical devices (except for general controls)
- x) machinery and systems which especially require the high level of reliability and safety

### [Acceptance inspection]

In connection with the Products you have purchased from us or with the Products delivered to your premises, please perform an acceptance inspection with all due speed and, in connection with the handling of our Products both before and during the acceptance inspection, please give full consideration to the control and preservation of our Products.

### [Warranty period]

Unless otherwise stipulated by both parties, the warranty period of our Products is three years after the purchase by you or after their delivery to the location specified by you. The consumable items such as battery, relay, filter and other supplemental materials are excluded from the warranty.

### [Scope of warranty]

In the event that Panasonic Industry Co., Ltd. confirms any failures or defects of the Products by reasons solely attributable to Panasonic Industry Co., Ltd. during the warranty period, Panasonic Industry Co., Ltd. shall supply the replacements of the Products, parts or replace and/or repair the defective portion by free of charge at the location where the Products were purchased or delivered to your premises as soon as possible.

However, the following failures and defects are not covered by warranty and we are not responsible for such failures and defects.

- (1) When the failure or defect was caused by a specification, standard, handling method, etc. which was specified by you.
- (2) When the failure or defect was caused after purchase or delivery to your premises by an alteration in construction, performance, specification, etc. which did not involve us.
- (3) When the failure or defect was caused by a phenomenon that could not be predicted by the technology at purchasing or contracted time.
- (4) When the use of our Products deviated from the scope of the conditions and environment set forth in the instruction manual and specifications.
- (5) When, after our Products were incorporated into your products or equipment for use, damage resulted which could have been avoided if your products or equipment had been equipped with the functions, construction, etc. the provision of which is accepted practice in the industry.
- (6) When the failure or defect was caused by a natural disaster or other force majeure.
- (7) When the equipment is damaged due to corrosion caused by corrosive gases etc. in the surroundings.

The above terms and conditions shall not cover any induced damages by the failure or defects of the Products, and not cover your production items which are produced or fabricated by using the Products. In any case, our responsibility for compensation is limited to the amount paid for the Products.

### [Scope of service]

The cost of delivered Products does not include the cost of dispatching an engineer, etc. In case any such service is needed, contact our sales representative.

Panasonic Industry Co., Ltd.

(MEMO)

---

## Panasonic Industry Co., Ltd.

1006, Oaza Kadoma, Kadoma-shi, Osaka 571-8506, Japan  
<https://industry.panasonic.com/>

Please visit our website for inquiries and about our sales network.

© Panasonic Industry Co., Ltd. 2017-2024

April, 2024

WUME-FP0HCOM-07