

Thank you for purchasing Panasonic products.
Read this Instruction Manual carefully and thoroughly for the correct and optimum use of this product.
Kindly keep this manual in a convenient place for quick reference.

⚠ WARNING

- Never use this product as device for personnel protection.
- In case of using devices for personnel protection, use products which meet laws or standards, such as OSHA, ANSI or IEC etc., for personnel protection applicable in each region or country.

1 FOR SAFETY USE

⚠ WARNING

- This product produces high voltages.
- Do not use this product in places where there may be a danger of flammable or combustible items being present.
- To prevent electric shock and to conduct proper discharge, be sure to ground a frame ground (F.G.) terminal of a controller.
- Do not place hands near the discharge needle. Doing so may cause electric shock.
- Since the tip of the discharge needle is sharp, take sufficient care in handling the discharge needle, or injuries may result.
- The high-voltage cable between the head and the high-voltage unit must be fixed and the minimum bend radius is R30 mm or more.
- In case of using at the bend radius R30 mm or less and using at moving part may cause fire and break down, etc. of the high-voltage cable.
- Clean the discharge needle regularly (about once a week). Otherwise, optimum charge removal performance may not be achieved, and accidents or operating problems may occur.
- If this product is used in a confined space, ozone emitted from this product may be detrimental. Be sure to provide ventilation.
- Do not direct ionized air toward the face. Ozone may cause irritation to places such as the nose and throat.

⚠ CAUTION

- This product has been developed / produced for industrial use only.
- Do not use this product for purposes other than electric charge removal.
- Do not use this product in environments which are outside the specification range, otherwise operating problems or damage may occur. In addition, the operating life of the product may become significantly reduced.
- This product is a precision device. Do not apply a shock to it by dropping, for example. Accidents or operating problems may occur.
- Never disassemble, repair or modify this product. Accidents or operating problems may occur.
- Do not throw this product in fire. It may explode or toxic fumes may be generated.
- Do not run the wires together with high-voltage lines or power lines or put them in the same raceway. This can cause malfunction due to induction.
- When connecting/removing the head or performing wiring or inspection work, be sure to turn off the power first. Not doing so may result in accidents, electric shock or operating problems.
- After connecting the cables, check that the connections are correct before turning on the power. If the cables are connected incorrectly, operating problems or accidents may occur.
- Verify that the supply voltage variation is within the rating.
- In case using switching regulator, be sure to connect F.G. terminal.
- Do not use any cables which have any damage (such as splitting or cracking), otherwise operating problems or accidents may occur.
- Avoid using the product in places where there are high levels of steam or dust in the air or where it might be directly exposed to water, oil or welding spatter.
- Do not touch the discharge needle with hard objects such as tools. If the discharge needle becomes broken, it will not provide sufficient charge removal performance, and moreover operating problems or accidents may occur.
- During installation, fasten the product securely. If it is not securely fastened or it is subjected to continuous vibration or shock, accidents or operating problems may result.
- Power cable that are 0.15mm² or more and 30m or less in total length for wiring. Also, keep the wiring as short as possible in order to prevent noise.
- When disposing of this product, treat it appropriately as industrial waste.
- After starting discharge, it takes approximately 30 minutes for charge removal performance to stabilize. Therefore, wait 30 minutes before adjusting ion balance.
- Use the correct combination of head, discharge needle unit and controller.

2 PART DESCRIPTION

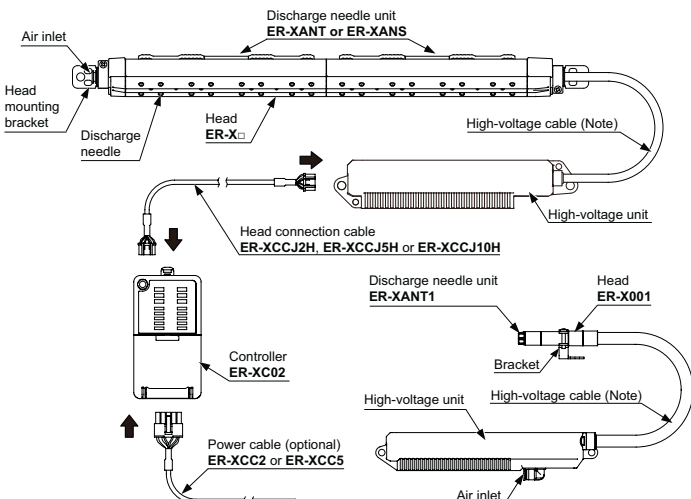

Note: The minimum bend radius of the high-voltage cable is R30 mm.

<Controller>

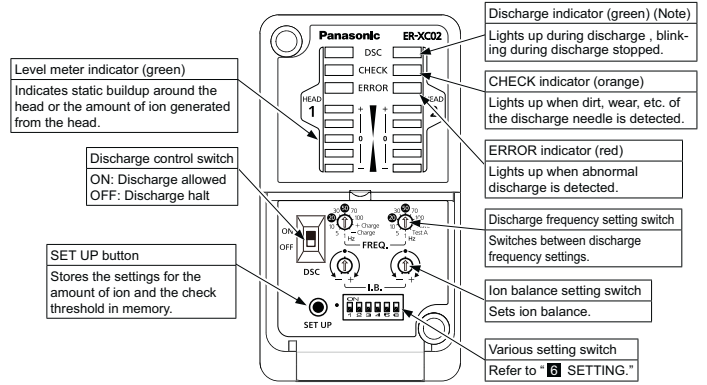

Note: An abbreviation of DISCHARGE.

3 INSTALLATION

<Head installation>

- Using 2 M4 screws or 1 M6 screw, mount the head onto the equipment housing. In case using this product in where there is vibration, use spring washers etc. as a countermeasure.
- Loosen the angle adjustment screw, adjust the head angle, and then fasten the head with the tightening torque of 0.5 N·m or less.
- The position of the head mounting bracket of the ER-X001 should be at least 20 mm from the end of the head. The tightening torque of the screw for head fixation should be 0.5 N·m or less.
- After mounting the head, set the controller according to the procedures in "6 SETTING" in order to appropriately remove static electricity.

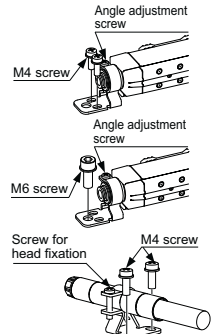

- Notes: 1) Be sure to ground the equipment housing onto which the head is mounted.
2) The distance between the head and the charge removing object should be 30 mm or more. If the static buildup of the charge removing object is 30 kV or more, set the distance to 50 mm or more.
3) If there is metal near the head or between the head and the charge removing object, ion is absorbed, hindering appropriate static removal. Install the head based on the above.
4) In case using the side mounting, the discharge frequency should be 10Hz or more.

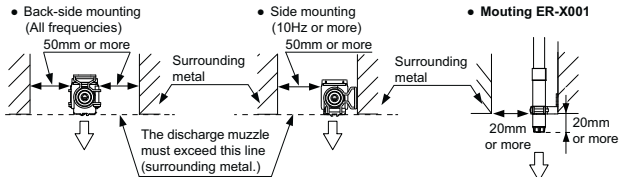

- 5) When installing two or more heads in face to face or parallel using different frequency, keep the distance between the heads 400mm or more.
When installing the heads face to face, install heads in distance that the heads can perform the charge removal of a side of the object individually.

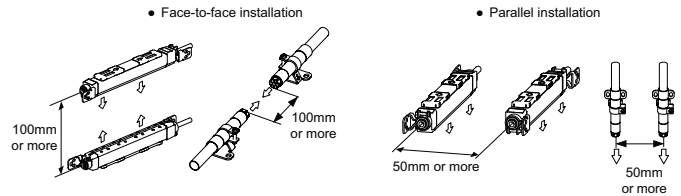

<High-voltage unit installation>

- Use 2 M4 screws or 2 M6 screws to fasten the head. The tightening torques for fastening, are as follows.
When using M4 screws: 1.2N·m
When using M6 screws: 2.5N·m

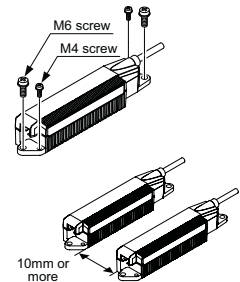

- Notes: 1) Do not place any objects on top of the high-voltage unit.
2) When using multiple heads, keep the distance of at least 10 mm between the high-voltage units.
3) When fastening the high-voltage unit using M6 screws, fasten before connecting the head connection cable.
4) Please fix the high-voltage unit of ER-X001 with M6 screw.

<Controller installation>

- Mount the controller on a 35 mm wide DIN rail or using M4 screws. For mounting dimensions, refer to "15 DIMENSIONS"

When mounting on a DIN rail

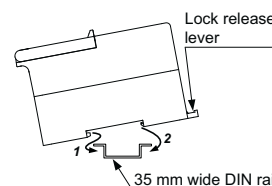

When mounting using M4 screws

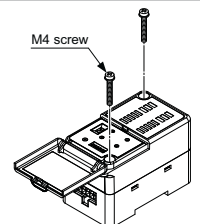

- Pull the lock release lever to remove this product from the DIN rail.
- The tightening torque should be 1.2 N·m or less.

4 WIRING

Power connector Pin arrangement



(Front view)

Housing: 5569-10A
[Manufactured by Molex Inc.]

Terminal No.	Terminal name	Color code
1	0V	Blue
2	COM(-)	—
3	Discharge control input	Pink
4	COM(OUT)	Violet
5	F.G. terminal	Green/Yellow
6	24V	Brown
7	COM(+)	—
8	COM(IN)	White
9	Alarm output	Orange
10	Error output	Black

Note: Wire colors are colors of power supply cable of option.

When connecting the output to negative common

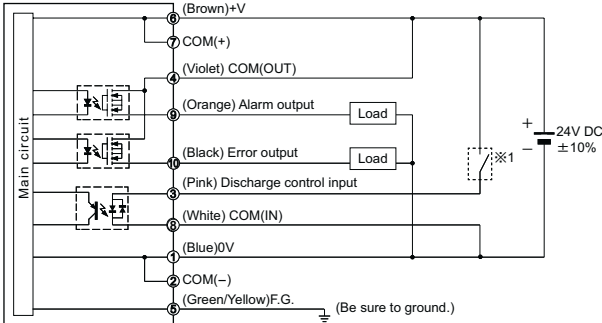

When connecting the output to positive common

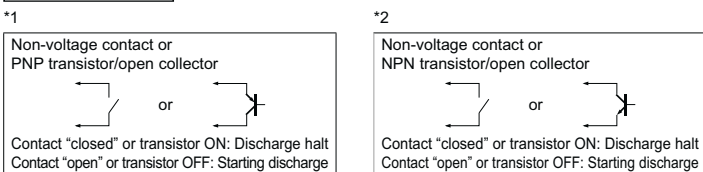
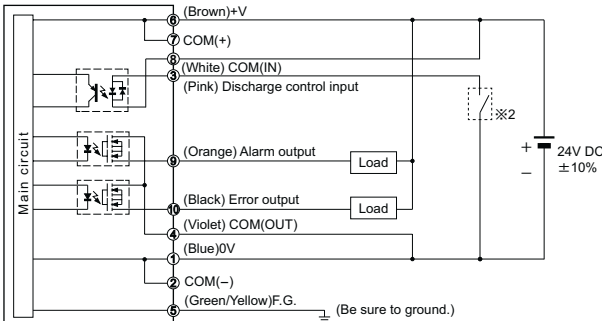

Notes 1) In order to prevent electric shock and perform proper discharge, be sure to ground the F.G. terminal. In addition, the head of ER-X001 and the F.G. terminal of a controller are common.
2) To stop discharge, turn ON the discharge control input for 20 ms or longer. To start discharge, turn OFF (open) the discharge control input. Discharge will start in 20 ms.

5 PIPING

- Air supplied to this product will reduce contamination of the discharge needle and improve the charge removal speed.
- The outer diameter of the air tube to fit to the air inlet portion of this product should be $\phi 6$ mm.
- Make sure that clean air (air containing no water, no oil and no dust) should be supplied.
- Since the pressure will drop when the air piping from the main pressure supply is extended or pneumatic components (e.g., needle valve, speed controller, mini filter) are added, keep an eye on the pressure supply to the ionizer making sure it is not in short supply. For the pneumatic components, select those that can accommodate the air supply flow rate.

<Except ER-X001>

Piping in the head

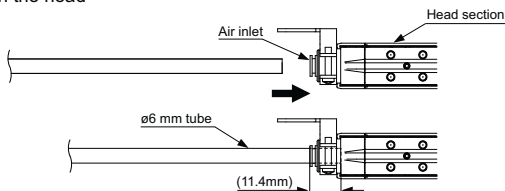

<ER-X001>

Piping in the High-voltage unit

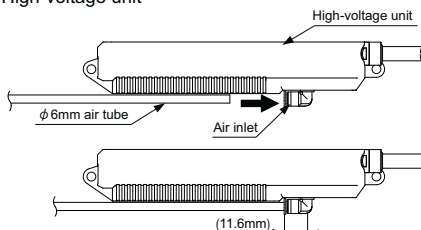

Note: After inserting the tube into the joint of this product, always make sure that the tube is all the way in and securely inserted.

Insufficient tube insertion will cause air leakage.

6 SETTING

- The amount of ion generation is set to enable appropriate charge removal.
- After mounting the head, follow the procedures below to configure the setting.
- When air is used, configure the setting while supplying air.
- Start the setting after 30 minutes of the discharge starting.

How to set the amount of ion generation

1. Turn the discharge control switch ON and the discharge control input "open" to start discharge. Make sure that the discharge indicator (green) lights up.

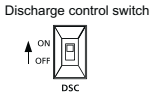

2. Depending on the installation distance, set the frequency using the discharge frequency setting switch.

Guideline when air is not supplied

Installation distance	Discharge frequency setting switch	Frequency
30~50mm	100	100Hz
	70	70Hz
50~200mm	50	50Hz
	30	30Hz
200~500mm	20	20Hz
	10	10Hz
500~1,000mm	5	5Hz
	1	1Hz

- When air is supplied, Set the frequency higher than when air is not supplied. Try 50 Hz (factory default setting) first to see if it removes static electricity. Since using air, discharge distance from the object can be longer.

- If the amount of static build up on the charge removing object is large, Set the frequency lower or make the installation distance shorter.

- In case the voltage resistance of the object is low, Set the frequency higher or make the installation distance longer.

Note: Depending on the head, different frequencies are accepted. If it is set to a wrong frequency, the discharge stops and the discharge indicator blinks. For accepted frequencies, refer to **TABLE SPECIFICATIONS**.

3. After mounting the head, adjust ion balance using the ion balance setting switch.

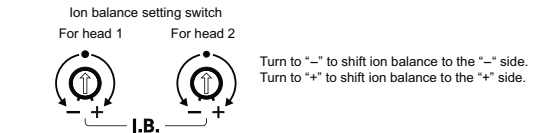

Note: Generally, ion reaching the charge removing object is affected by installation environment (nearby metals, temperature, humidity, etc.). Although this product has been adjusted for ion balance at the factory, the preadjusted ion balance may differ, depending on the customer's installation environment. For more appropriate static removal, please adjust ion balance according to your installation environment.

4. Press the SET UP button to lock in the setting. After the setting is completed, level meter indicators change from blinking to lighting up.



- Notes: 1) Conduct the maintenance before setting.
2) Before the setting up, be sure that the check indicator is turned OFF. In case the check indicator lights up or blinks, the set up is not started. For detail, refer to **TABLE TROUBLE SHOOTING**.
3) This product works at factory setting before finishing setup (level meter indicator blinks.) And ion balance control function works at OFF in despite of setting of ion balance control switch. After press down the set up button and finishing the setting (level meter indicator lights up), starts ion balance control and Check detection (detecting function of ion generation depression) amount based on your environment.
4) It takes 30 seconds to 1 minute to complete a setup procedure. Do not change the ambient environment at the time. In case ambient environment is changed, the set up is not conducted and level meter indicator may blink.
5) In case the discharge frequency setting switch or the ion balance control switch is changed or installed environment is changed, conduct the setup again.
6) The set up is conducted to two heads. Do not wire head that you do not use.
7) Setting the ion balance setting switch shown right, level meter indicators blink. And pushing down the SET UP button for 3 seconds in this setting, the setting will be the factory setting.

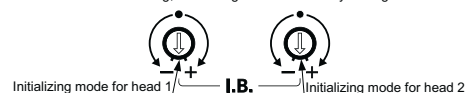

Various setting switch

Various setting switch	Name	Function
	Check level changeover switch	Switches between ion generation levels to output an alarm. ON: Lights up the CHECK indicator and outputs an alarm, when ion generation is reduced to a level that affects static removal. OFF: Set this if you wish to be alerted soon after ion generation is reduced.
	Ion balance control switch	Switches between automatic ion balance control function settings. ON: Enables automatic ion balance control function. Senses the amount of ion generation and automatically controls it to match the setting of the ion balance setting switch. OFF: Disables automatic ion balance control function. Ion continues to generate at the discharge ratio setting of the ion balance setting switch.
	Indicator changeover switch	Switches between indications of the level meter indicator (green). ON: Indicates the static buildup state of immediate head. It shifts to the "+" or "-" side depending on the amount of buildup. (Example) When the charge removing object is positively charged. OFF: Indicates the amount of ion the head generates. Plus ion generated is indicated on the "+" side and minus ion on the "-" side. (Example) When a sufficient amount of plus and minus ions are generated.
	2 heads control switch	Sets ion generation timing for two heads. If the two heads have different discharge frequency, this setting will be invalid, and ion will be generated at the frequency timing of each head. ON: When head 1 is generating plus ion, head 2 also generates plus ion. (synchronous mode) OFF: When head 1 is generating plus ion, head 2 generates minus ion. (inversion mode)
	—	Not used.

Notes: 1) All factory default settings are ON.
2) Checking function (detecting function of ion generation depression) is based on amount of ion generation which was set in the set up.

7 Charging function

- By setting the discharge frequency setting switch for head 1 to "+ Charge" or "- Charge", head 1 can be used as charger.
- In the + charging mode, the upper 3 lamps of the level meter indicator light, while in the - charging mode, the lower 3 lamps light.

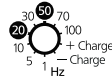

Notes: 1) Immediately after changing the discharging frequency setting switch, discharging stops and the level meter indicator lamps go out. To enable the charging function, turn charging OFF and then ON again.
2) Head 2 performs normal removal of static electricity.
3) The charging function cannot be used in the ER-X001. (The discharging stops.)

8 OUTPUT FUNCTIONS

<Alarm output>

- Normally OFF
- The alarm output switches from OFF to ON at the occurrence of a reduction in ion generation, installation error, excessive discharge to nearby metals and abnormal setup data, etc.
- During an alarm, discharge (charge removal) continues.

<Error output>

- Normally ON (Turning ON after 3 seconds of power supplying)
- The error output switches from ON to OFF at the occurrence of abnormal discharge, output short circuit, etc.
- During an error, discharge (charge removal) stops.
- The error will not be cleared until its cause is eliminated and the power or discharge control switch is turned on again.

Note: Refer to "TROUBLE SHOOTING" for actions to be taken at the occurrence of an alarm and error.

<Forced output functions>

- With this product, alarm output and error output can be forcedly-outputted by setting the discharge frequency setting switch for head 2 to "Test A" or "Test E", respectively.

Discharge frequency setting switch for head 2	Output	Description
	Alarm output	Set the discharge frequency setting switch for head 2 to "Test A". CHECK indicator turns up, and alarm output will be forced to switch from OFF to ON, generating an output.
	Error output	Set the discharge frequency setting switch for head 2 to "Test E". ERROR indicator turns up, and error output will be forced to switch from ON to OFF, generating an output.

Note: During the enforced output, discharging of head 2 will be stopped.

9 TROUBLE SHOOTING

- Always be sure to turn off the power before checking the discharge part.

Output	Indicator	Cause	Remedy
-	Discharge indicator (Green) flashes	Discharge stopped.	Check whether the discharge control switch is ON, the discharge control input is not shorted or discharge frequency setting switch is not at "Test A" or "Test E".
Alarm ON	CHECK indicator (orange) lights up	The discharge needle unit is not in place.	Check whether all the discharge needle unit is properly fitted to the main body.
		Discharge needle is dirty	Clean the discharge needle and its surroundings. Refer to "11 MAINTENANCE" for details.
		Discharge needle is worn	If the CHECK indicator (orange) does not turn off even after cleaning, replace the discharge needle unit, as it may be worn.
	F.G. is not connected	Check whether the F.G. terminal is connected.	
Alarm ON	CHECK indicator (orange) flashes	Excessive discharge to nearby metals	Referring to "3 INSTALLATION" place the head away from nearby metals. Higher discharge frequency may help reduce excessive discharge.
	ERROR indicator (red) flashes	Communication error between head and controller	Turn on the power again. If this error occurs as a result of power shutoff during setup, press the SET UP button again to complete setup.
Error OFF	ERROR indicator (red) lights up	Abnormal discharge to nearby metals.	Check whether the head is installed in appropriate environment. Also, check whether any metal may come close to the discharge needle.
		Abnormal discharge from the charge removing object.	A large amount of static buildup on the charge removing object may cause abnormal discharge. Increase the installation distance and the speed of charge removal with air.
		Foreign objects attached to the discharge needle.	Foreign objects may cause abnormal discharge. Clean the discharge needle and its surroundings before use.
		Dew condensation around the discharge needle.	If the temperature environment changes rapidly, abnormal discharge may result due to dew condensation. Clean the discharge needle and its surroundings, and use it under a stable environment.
		Air is dirty.	Water or oil content in the air attached to the discharge needle may cause abnormal discharge. When air is used, use clean dry air only.
		Incorrect head connection	Use the correct combination of head and controller.
		Head not connected.	Check whether the head is connected to the controller.
		Damage	If the error does not clear after turning on the power again and taking the above actions, contact us.
-	Level meters (green) flash	Setup is not completed.	Press the SET UP button to lock in the setting.
-	Level meters (green) light up in order	Performing setup	It takes 30 seconds to 1 minute to complete the setup.
-	Level meters (green) flashes	Initializing mode	Check that the position of the ion balance setting switch is in Initializing setting mode. Refer to "6 SETTING" for details.
-	All indicator flash momentarily	Output short circuit.	Check whether the output is shorted or whether the output load is too high.

- In case you got electric shock except discharge needle, F.G. terminal of controller is not connected properly. Be sure that the F.G. terminal is connected properly at the end.

10 RoHS Directive

This product is in compliance with the RoHS Directive (EU).

11 MAINTENANCE

- Be sure to turn off the power and air before performing maintenance work.
- Since the tip of the discharge needle is pointed, take sufficient care when cleaning.
- Take care not to damage the tip of the discharge needle.
- Clean the discharge needle and its surroundings, where dirt or dust accumulates after long use.
- Clean it regularly, about once a week. Otherwise optimum charge removal performance may not be achieved, and accidents or operating problems may occur.
- The discharge needle is a consumable part. If charge removal performance does not return to normal after the discharge needle has been cleaned, then the needle unit should be replaced.
- When replacing the discharge needle unit because of natural wear and use, replace all units at the same time.

How to clean the discharge part

- Always make sure that the discharge control switch or the power is OFF.
- Remove any dirt from the discharge needle and its surroundings using a brush, cotton swab, etc. moistened with alcohol.

<Except ER-X001 >

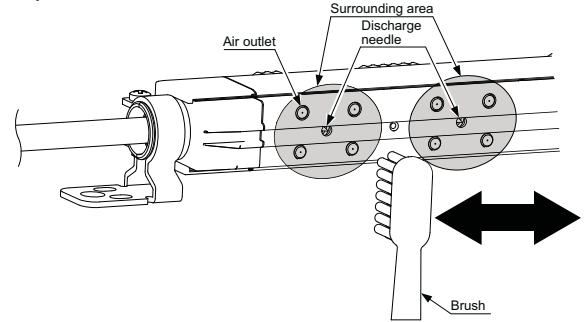

<ER-X001 >

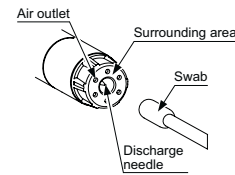

- In case of supplying air, there is possibility that around discharge needle or entire discharge unit get dirty by oil or moisture included in the supplying air. Before replacing the discharge unit, check the blot around discharge needle and clean the entire unit and check the dischargeability is recovered. (the discharge needle unit can be cleaned up easily with commercial super sonic washer.)

How to replace discharge needle unit

<Except ER-X001 >

- Slide the lock release lever of the discharge needle unit in the arrow 1 direction shown in the illustration below.
- Pull out the discharge needle unit toward the arrow 2 direction.

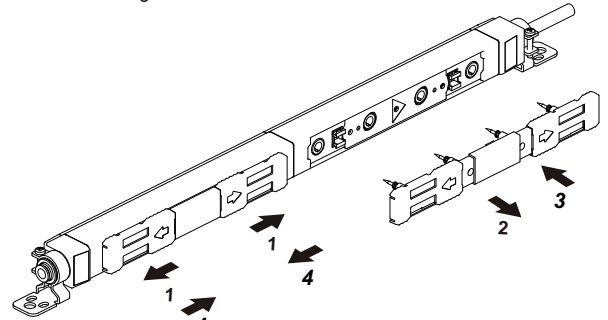

- Insert the discharge needle unit (sold separately) in the arrow direction.
- Slide the lock release lever of the discharge needle unit in the arrow 4 direction to lock in the discharge needle unit.

Notes: 1) Do not touch the interior of the main body when the discharge needle unit is removed. Doing so will cause accidents or operating problems.
2) An O-ring is used at the base of the discharge needle. When replacing the discharge needle unit, make sure that the O-ring is in place.

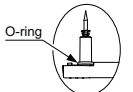

<ER-X001 >

- Turn the discharge needle unit counterclockwise (CCW) and pull out.
- Insert the discharge needle unit (sold separately) vertically into the main body, and turn clockwise (CW) all the way to the back.

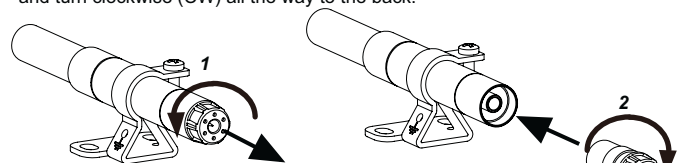

Notes: 1) Do not use this product if the discharge needle unit is not inserted all the way to the back. It may cause an accident or failure.
2) If the discharge needle unit is inserted at a slant and turned forcibly, the screw threads may strip and the unit may not be inserted all the way to the back.

Good

Not Good

12 SPECIFICATIONS

Type	Head					
	ER-X001	ER-X008	ER-X016	ER-X032	ER-X048	ER-X064
Model No.	ER-X001	ER-X008	ER-X016	ER-X032	ER-X048	ER-X064
Effective charge removal width	50mm	80mm	160mm	320mm	480mm	640mm
Charge removal time	0.3 second or less (Note 1) 0.5 second or less (Note 2)	1 second or less (Note 3)				
Ion balance	±30V or less (Note 2) (Note 3) (Note 4)					
Discharge method	Pulse AC method (Note 5)					
Discharge output voltage	Approx. 7.000V					
Ozone generation	0.01ppm or less (Note 2) (Note 3)					
Maximum air pressure	0.5MPa					
Applicable fluid	Air (dried clean air) (Note 6)					
Ambient temperature	0 to +50°C (ER-X001: 0 to +40°C) (with no dew condensation). For storage: -10 to +65°C					
Ambient humidity	35 to 65%RH. For storage: 35 to 85%RH					
Vibration resistance	10 to 55Hz frequency (ER-X001: 10 to 150Hz frequency), 0.75mm amplitude for 2 hours in each of XYZ directions (when the power is off)					
Shock resistance	Resistance 100 m/s ² (approx. 10G), 3 times in each of XYZ directions (when the power is off)					
Enclosure grounding method	Floating					
Material	Main unit enclosure: PPS, Stainless steel (SUS). Head mounting bracket: Stainless steel (SUS). Discharge needle: PFA, PC, PPS, Tungsten (Note 7).					
High-voltage cable length	1.2m	0.5m (Note 8)				
Weight	Approx. 370g	Approx. 330g	Approx. 410g	Approx. 530g	Approx. 650g	Approx. 780g

- Notes: 1) In condition of discharge distance 50mm, center of the product, discharge wavelength 50Hz and air supply 60l/min(0.3MPa).
2) In condition of discharge distance 50mm, center of the product, discharge wavelength 50Hz and no air supply.
3) In condition of discharge distance 100mm, center of the product, discharge wavelength 50Hz and no air supply.
4) Ion balance is average of plus and minus. Also, the specification value is typical value in condition of less than ±10°C ambient temperature change, set the ion balance after 30 minutes of the discharge starting, switching on the ion balance control function.
5) For ER-X001 the discharge frequencies of 50Hz, 20Hz are accepted. For ER-X008 and high-voltage cables 1m/2m, the discharge frequencies of 50Hz, 30Hz, 20Hz, 10Hz, 5Hz, and 1Hz are accepted. For other heads, 100Hz, 70Hz, 50Hz, 30Hz, 20Hz, 10Hz, 5Hz, and 1Hz are accepted.
6) The dried clean air is dried (dew point: equivalent of -20°C) and filtered (mesh-size: equivalent of 0.01µm) air.
7) Silicon needles are also available. Please contact us for details.
8) High-voltage cables are also available in 1m and 2m lengths. Please contact us for details.

Type	Controller
Model No.	ER-XC02
Number of charge removal heads connected	Maximum 2 units
Supply voltage	24V DC±10%
Current consumption	450mA or less when connecting 1 head. 800mA or less when connecting 2 heads.
Indicator	Displays status of Head 1 and 2
DSC (Discharge)	Green LED [Lights up during discharge, blinking during discharge stopped.]
CHECK	Orange LED [Lights up when dirt, wear, etc. of the discharge needle is detected.]
ERROR	Red LED [Lights up when abnormal discharge is detected.]
Level meter	Green LED [5 levels, Lights up depending on amount of the charge or ion generation.]
Output	PhotomOS relay output • Maximum load current: 100mA • Applied voltage: 30VDC or less (between output-output common) • Residual voltage: 1.5V or less (at load current of 100mA)
ALARM, ERROR COM (COM OUT)	ALARM: ON when dirt or wear of the discharge needle is detected; OFF when operation is normal. ERROR: OFF when abnormal discharge is detected; ON when operation is normal.
Output operation	Equipped (automatic reset type)
Short-circuit operation	Equipped (automatic reset type)
Input	Photo coupler input • Input current: 4.5mA or less • Input voltage: 30VDC or less (between input-input common) • Input impedance: about 7kΩ.
Discharge control input (DSC OFF) COM (COM IN)	Discharge allowed: Open. Discharge halt: 24V or 0V shorted.
Input operation	Discharge allowed: Open. Discharge halt: 24V or 0V shorted.
Ambient temperature	0 to +50°C (with no dew condensation). For storage: -10 to +65°C
Ambient humidity	35 to 65%RH. For storage: 35 to 85%RH
Voltage resistance	AC 1000V, 1 minute, completely charged part/between enclosures AC 500V, 1 minute, charged part/between F.G.
Insulation resistance	20 MΩ or more at DC 250V, completely charged part/between enclosures
Vibration resistance	10 to 150 Hz frequency, 0.75mm amplitude for 2 hours in each of XYZ directions (when power is off)
Shock resistance	Resistance 100 m/s ² (approx. 10G), 3 times in each of XYZ directions (when the power is off)
Enclosure grounding method	Floating
Material	Enclosure: ABS
Weight	Approx. 130g
Accessories	Power supply / I/O connector: 1 set (Housing 5557-10R, terminal 5556TL [manufactured by Molex Inc.]) Ground wire approx. 3.7m: 1pc.

Type	Head connection cable		
Model No.	ER-XCCJ2H	ER-XCCJ5H	ER-XCCJ10H
Length	2m	5m	10m
Cable	Cabletyre cable with connectors at both ends		
Weight	Approx. 120g	Approx. 290g	Approx. 560g

13 OPTIONS (sold separately)

• Spare discharge needle unit

For ER-X016 to X064
ER-XANT, ER-XANS (Note)

For ER-X008
ER-XANT2

For ER-X001
ER-XANT1

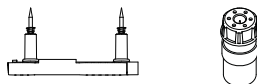
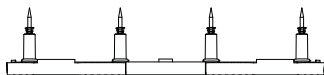

• AC adapter ER-XAPS-EX



• Power cables ER-XCC2 (2m) ER-XCC5 (5m)



• For ER-X016 to X064 Discharge part protective cover ER-XACVR

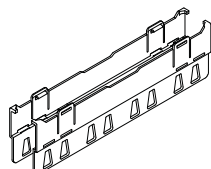

Note: ER-XANT of the spare discharge needle unit is a tungsten needle, and ER-XANS is a silicon needle. Use it combined correctly with the head.

14 CE MARKED PRODUCT

- This product is CE marked product.
- Contact for CE**
Panasonic Marketing Europe GmbH Panasonic Testing Center
Winsbergring 15, 22525 Hamburg, Germany



15 DIMENSIONS (Unit: mm)

<Head part> ※ Please refer to the instruction manual of the head part for the form dimensions of ER-X001.

• Head

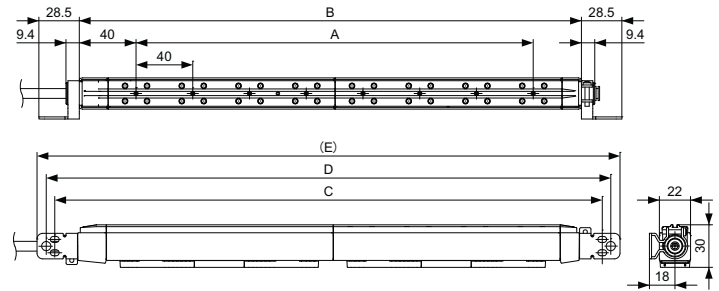

型式名	ER-X008	ER-X016	ER-X032	ER-X048	ER-X064
A	40	120	280	440	600
B	106	194	354	514	674
C	138	226	386	546	706
D	150	238	398	558	718
(E)	163	251	411	571	731

• High-voltage unit

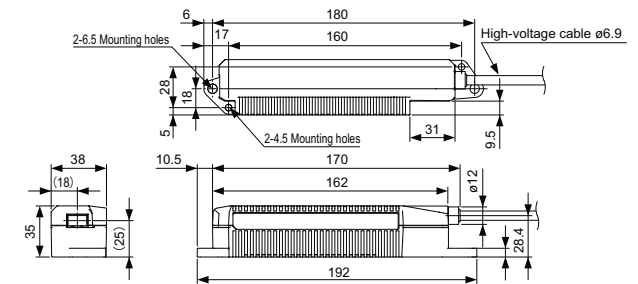

<Controller>

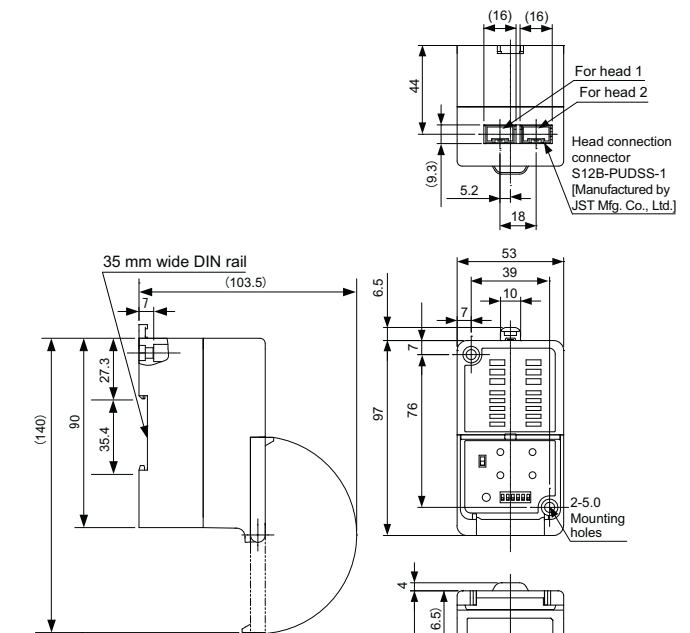

<Head connection cable>

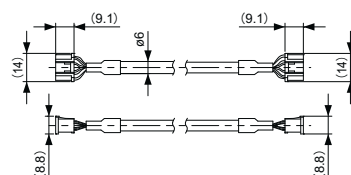

<Power cable>

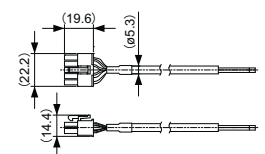

Panasonic Industrial Devices SUNX Co., Ltd.

<http://panasonic.net/id/pidsx/global>

Overseas Sales Division (Head Office)

2431-1 Ushiyama-cho, Kasugai-shi, Aichi, 486-0901, Japan
Phone: +81-568-33-7861 FAX: +81-568-33-8591

About our sale network, please visit our website.

PRINTED IN JAPAN

© Panasonic Industrial Devices SUNX Co., Ltd. 2014