



DIGITAL LASER SENSOR

LS-400 SERIES

PRO Mode Operation Guide

INDEX

1. Functional Description	
1-1. Functional Description.....P. 1	
1-2. Setting ProcedureP. 1	
2. Diagram of Functions and Settings	
2-1. Diagram of Functions and Settings.....P. 2	
3. Others	
3-1. Precautions When Selecting Settings...P. 3	
3-2. Factory SettingsP. 4	
3-3. Error Display Indicator ReadingsP. 5	
4. Settings for NAVI Mode	
4-1. NAVI Mode Functions and SettingsP. 6	
4-2. Teaching Mode	
(when using normal mode).....P. 11	
4-3. Teaching Mode	
(when using window comparator mode)...P. 14	
4-4. Teaching Mode	
(when using hysteresis mode)P. 18	
4-5. Output Operation Setting ModeP. 22	
4-6. Timer Setting ModeP. 23	
5. PRO1 Mode	
5-1. PRO1 Mode Functions and Settings...P. 24	
5-2. Response Time Change Function.....P. 25	
5-3. Hysteresis Function.....P. 26	
5-4. Shift FunctionP. 27	
5-5. M.G.S. FunctionP. 28	
5-6. Emission Halt FunctionP. 29	
6. PRO2 Mode	
6-1. PRO2 Mode Functions and Settings...P. 30	
6-2. Display Switching FunctionP. 32	
6-3. Display Turning Function.....P. 33	
6-4. ECO Mode Function.....P. 34	
6-5. Period Holding Function.....P. 35	
6-6. Current Value Storage Function.....P. 36	
6-7. Stored Value Comparison Function ...P. 37	
7. PRO3 Mode	
7-1. PRO3 Mode Functions and Settings...P. 38	
7-2. Data Bank Load FunctionP. 39	
7-3. Data Bank Save FunctionP. 40	
8. PRO4 Mode	
8-1. PRO4 Mode Functions and Settings...P. 41	
8-2. Copy FunctionP. 42	
8-3. Selection for Transmission Change	
to Permit / Not to PermitP. 43	
8-4. External Input Switch Setting Function...P. 44	
8-5. Backup Setting FunctionP. 45	
9. PRO5 Mode	
9-1. PRO5 Mode Functions and Settings...P. 46	
9-2. Code Setting Function.....P. 48	
9-3. 0-Adjust Setting FunctionP. 49	
9-4. Setting Reset Function.....P. 50	
9-5. CUSTOM Mode Display FunctionP. 51	
10. PRO6 Mode	
10-1. PRO6 Mode Functions and Settings...P. 52	
10-2. Output 1 Sensing Mode SettingsP. 53	
10-3. Output 2 Sensing Mode SettingsP. 55	
11. Others	
11-1. Key Lock Function.....P. 56	

1 Functional Description

1-1. Functional Description

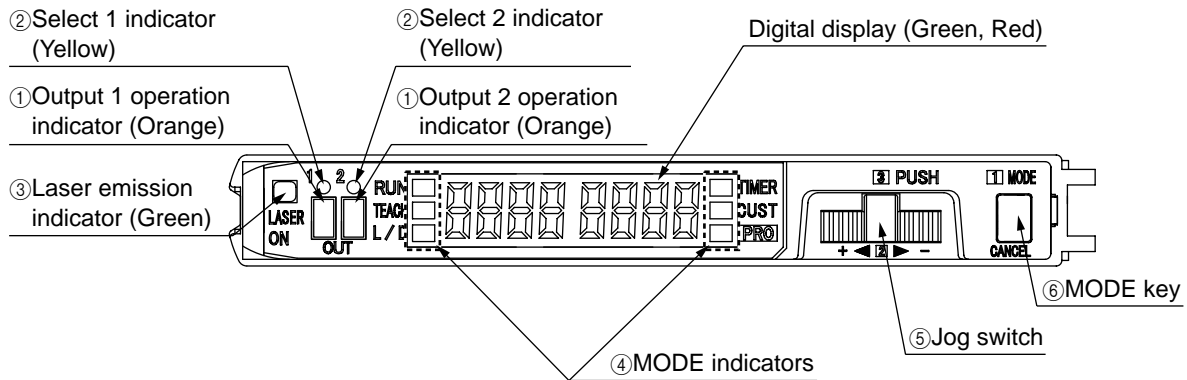

1, **2** and **3** are in the correct order for selecting settings.

- ① Output 1, 2 operation indicator (Orange)..... Lights up when output 1 or output 2 is ON.
- ② Select 1, 2 indicator (Yellow)..... Lights up when output 1 or output 2 is selected.
- ③ Laser emission indicator (Green)..... Lights up when laser is emitted.
- ④ MODE indicators.....
 - RUN (Green) : Lights up during normal sensing operation.
 - TEACH (Yellow) : When this indicator lights up, in normal mode, the 'threshold value' can be set by utilizing either '2-level teaching', 'limit teaching' or 'full-auto teaching'. In window comparator mode and hysteresis mode, the 'threshold value' can be set by either '1-level teaching', '2-level teaching' or '3-level teaching' whenever this indicator lights up. Span adjustment can be carried out when using rising differential and trailing differential modes.
 - L/D ON (Yellow) : When this indicator lights up, the output operation setting can be done.
 - TIMER (Yellow) : When this indicator lights up, timer operation and timer period setting can be done.
 - CUST (Yellow) : When this indicator lights up, function is stored in the CUSTOM mode, can be set.
 - PRO (Yellow) : When this indicator lights up, further advanced functions, such as the copying and memory functions, can be set.
- ⑤ Jog switch..... Moving this switch in the '+' or '-' direction, allows different items to be viewed for selection and pressing the switch then confirms the selected setting.
- ⑥ MODE key..... This key is used to select operating modes and to cancel settings while they are being configured.

1-2. Setting Procedure

The use [MODE key] and [Jog switch] are utilized to configure various settings.

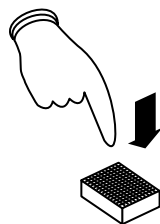
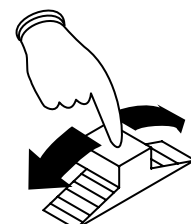
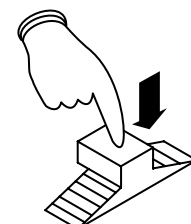
- | | | |
|--|---|--|
| <p>1 Press the [MODE key] (mode selection / cancellation)</p>  | <p>2 Turn the [Jog switch] in the '+' or '-' direction (chooses setting for selection)</p>  | <p>3 Press the [Jog switch] (confirms the selected setting)</p>  |
|--|---|--|

Cancel: If the [MODE key] is pressed, the amplifier will return to the previous settings status, immediately before the [Jog switch] was pressed (the selected setting has been confirmed).

Selection and confirmation of settings are performed according to the order of the numbers, as shown on the amplifier: **1**, **2** and **3**.

2 Diagram of Functions and Settings

2-1. Diagram of Functions and Settings

The amplifier of **LS-400** series features and settings are generally classified into two main modes; the 'NAVI' mode for items and settings that are frequently reconfigured, and the 'PRO' mode that contains more detailed settings.

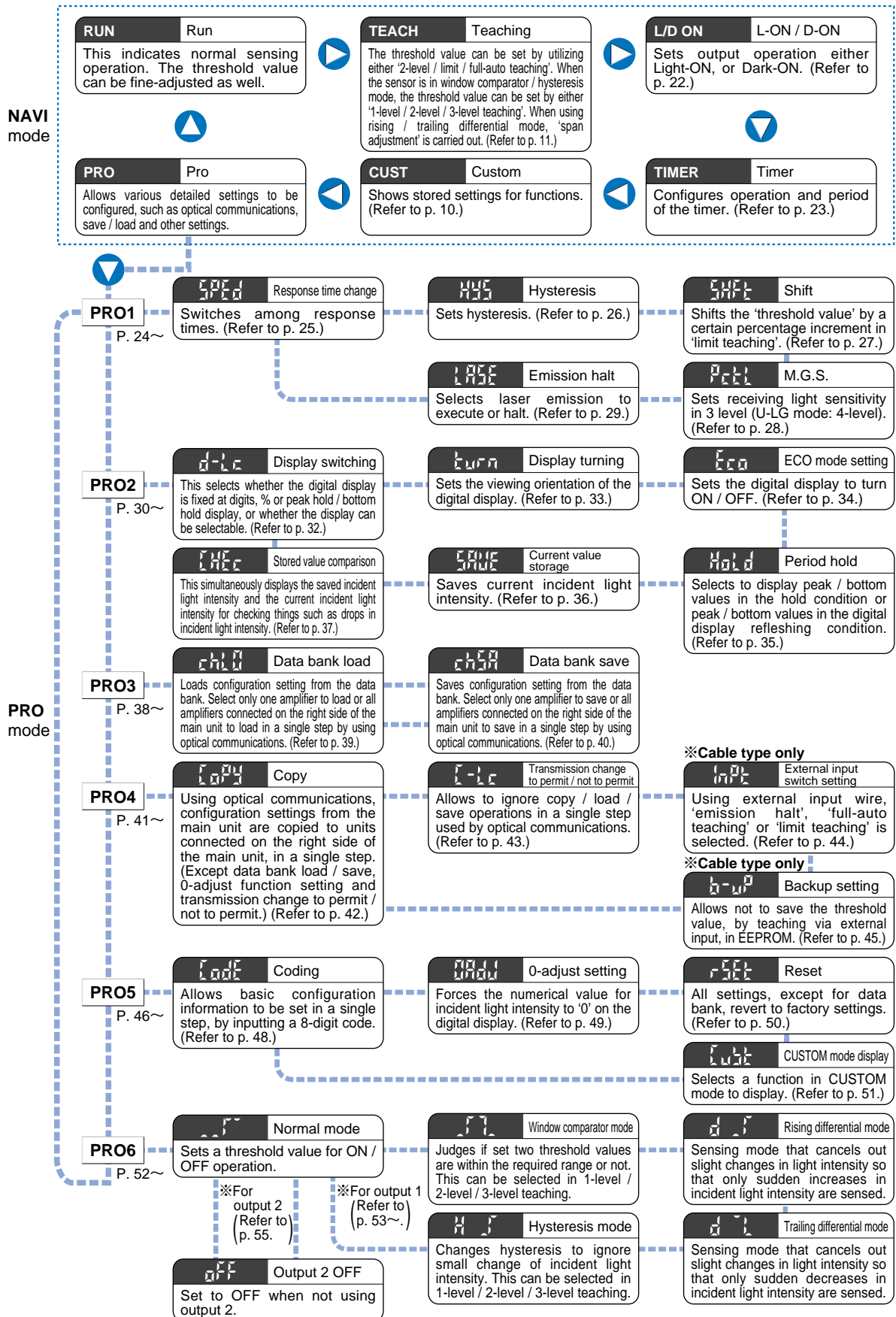

3 Others

3-1. Precautions When Selecting Settings

- Be sure to set each item after selecting output 1 or output 2.
- The items that can be set in output 1 and output 2 respectively are only ① Threshold value, ② Output operation, ③ Timer operation and Timer period, and ④ Sensing mode (Output 2 can only be selected in normal mode). The items other than those are common. (However, in case of setting with the direct code, a combination of the output 1 / 2 can be set only for output operation. The items other than output operation are valid only for the output 1.)

Canceling operations

- To cancel any operation, press the [MODE key]. If the [MODE key] is pressed once, the amplifier will return to the previous settings status, immediately before the [Jog switch] was pressed and the selected setting has been confirmed.

Example: When operating in PRO mode.

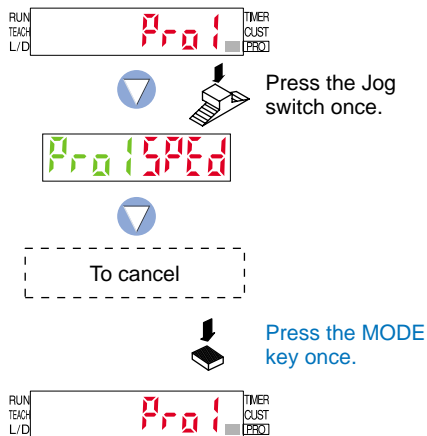

- ① Select 'PRO mode'.
- ② If the [Jog switch] is pressed once, the amplifier enters the 'response time change' state. [PRO] { move left side (Green)}
- ③ To cancel the 'response time change' operation, press the [MODE key] once.
- ④ The display will return to the previous [PRO1 mode] selection screen.

Confirming settings

- When changing the status of any setting, ensure that the selected setting is subsequently confirmed. If confirmation is not performed, the new setting will not take effect.

Example: When setting response time change.

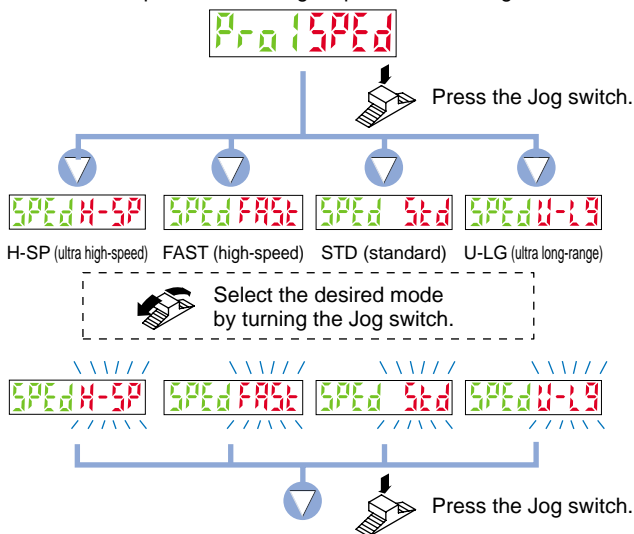

The digital display will quickly blink to confirm the setting.

- ① Select 'response time change'.
- ② If the [Jog switch] is pressed, the current mode (red) will be displayed. * The factory setting is 'STD (standard)'.
- ③ If the [Jog switch] is turned, the digital display (red) will blink. Select the desired mode.
- ④ If the [Jog switch] is pressed, the digital display (red) will quickly blink, confirming the setting. (The digital display will not blink if the setting has not been changed.)

Operation protection

- You can use the 'key lock function' to protect these operations. (Refer to p. 56.)

Key lock function

This function can be used to prevent the operator from accidentally changing the sensor settings.

Output switching

- Set the sensing mode (PRO6) for output 1 to normal mode beforehand.
In modes other than normal mode, this is fixed at output 1.
- Press the MODE key for more than 2 seconds when in NAVI mode. If Output 1 has been selected, the Select 1 indicator (yellow) lights up. If Output 2 is being selected, the Select 2 indicator (yellow) lights up.

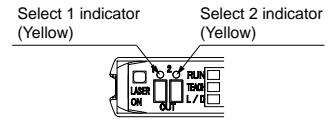

Automatic interference prevention function

- To operate the automatic interference prevention function, you need to install the amplifiers so that they are directed against each other and carry out optical communication.
The automatic interference prevention function allows up to four sensor heads to be installed so that they are directed against each other.
(However, the automatic interference prevention function cannot be used in H-SP mode.)

3-2. Factory Settings

Factory settings for the **LS-400** series are indicated below:

If the amplifier is reset using the '**9-4 Setting Reset Function**' from 'PRO5 Mode' on p. 50, the resulting settings will be those indicated below:

NAVI mode

Item	Settings	Digital display
Threshold value	Output 1: 40, Output 2: 60	Output 1: 40, Output 2: 60
Output operation	L-ON·L-ON (Output 1·Output 2)	L-ON
Timer operation	Without timer (Output 1·Output 2)	000
CUSTOM mode display	Response time change	5000

PRO mode

Item	Settings	Digital display
Response time	STD (standard)	500
Hysteresis	H-02 (standard)	H-02
Amount of shift during limit teaching	15 %	150
M.G.S.	Level 3	1001
Emission halt	Laser emission ON	ON
Display switching	Incident light intensity display only	ON
Display turning	Digital display turning OFF	OFF
ECO mode	ECO OFF	OFF
Period hold	Hold OFF	OFF
Selection for transmission change to permit / not to permit	Lock OFF	OFF
External input switch setting (Note)	Emission halt	L-ON
Backup setting (Note)	OFF	OFF
Code setting	00000000	0000 0000
0-adjust setting	OFF	OFF
Output 1 / 2 sensing mode	Normal mode	L-ON

Note: Equipped with cable type only.

3-3. Error Display Indicator Readings

In case of errors, attempt the following measures:

Digital display	Error description	Measures
E-1	The load has short-circuited and excess current is flowing.	Turn off the power, then check the load.
E-4	Disconnected sensor head wire error.	Check the sensor head connection status.
E-5	Communication error has occurred at time of connection.	Confirm that all amplifiers are properly connected to each other.

4 Settings for NAVI Mode

4-1. NAVI Mode Functions and Settings

In [NAVI mode], frequently changed settings can be easily configured. Settings for four functions can be configured.

RUN : Normal Sensing Operation

This indicates normal sensing operation. Threshold value (green) and incident light intensity (red) are displayed in real time. Manual fine adjustment of the 'threshold value' can be performed during normal sensing operation.

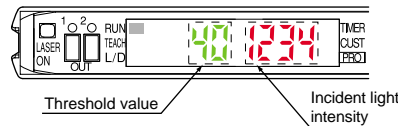

*The incident light intensity display can display a maximum value of 4,000 in H-SP (ultra high-speed) mode and FAST (high-speed) mode. In STD (standard) mode and U-LG (ultra long-range) mode, it can display up to a maximum value of 9,999.

Threshold value fine adjustment function

Turn the jog switch to either '+' (left) or '-' (right) to increase / decrease the threshold value.

If there are no key operations after a certain period of time or if the MODE key is pressed (to change to TEACH), the digital display (green) will blink and the setting will be confirmed.

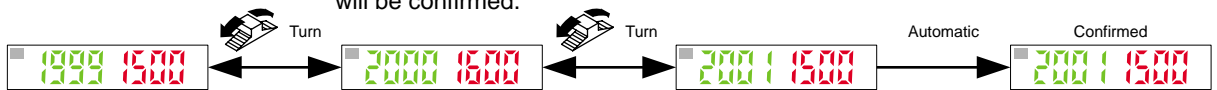

* When you turn the jog switch to '+' or '-' in window comparator mode or hysteresis mode, the threshold value will increase or decrease after the threshold value 1 '1.5k' or the threshold value 2 '2.5k' is displayed. Each time the jog switch is pressed, the display switches between the '1.5k' threshold value 1 and '2.5k' threshold value 2.

After '1.5k' or '2.5k' is displayed, the respective threshold value will be displayed.

If you turn the jog switch to '+' when the output 1 '1.5k' is displayed, the following will be displayed.

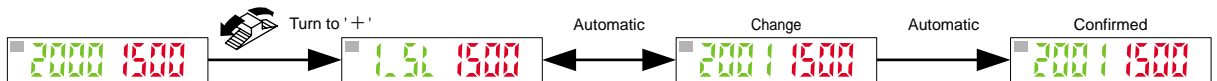

TEACH : Teaching Mode

Refer to p. 11 ~ for setting procedure

This mode sets the 'threshold value' by utilizing teaching.

When using normal mode

The 'threshold value' can be set with any of the 3 teaching methods, '2-level teaching', 'limit teaching' and 'full-auto teaching'.

2-level Teaching P. 11

2-level teaching is a method of setting the threshold value by teaching the amplifier two different status conditions - sensing object present and sensing object absent.

The 'threshold value' is usually set using this method.

Retroreflective type



Reflective type



Limit Teaching P. 12

Teaches only the status condition in which no sensing object is within sensing range (status in which incident light intensity is stable). This method is used to set a 'threshold value' for conducting sensing in the presence of a background, or when extremely small objects are to be detected.

Retroreflective type

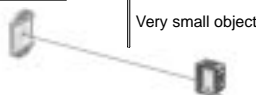

Reflective type



Full-auto Teaching P. 13

This method is used to set the threshold value while the sensing objects are still moving on the production line, without stopping the production line.

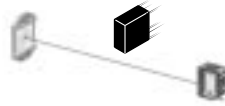

TEACH : Teaching Mode

Refer to p. 14 ~ for setting procedure

When using window comparator mode

The 'threshold value' can be set with any of the 3 teaching methods ('1-level teaching', '2-level teaching' and '3-level teaching'). By setting two 'threshold values', both ON and OFF can occur between the two threshold value levels.

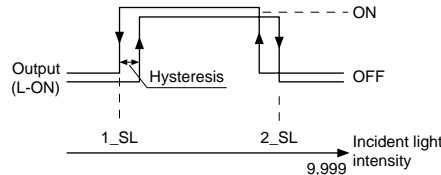

1-level Teaching P. 14

This sets the shift value to any desired value, and sets the threshold values (1_SL, 2_SL) by means of 1-level teaching.

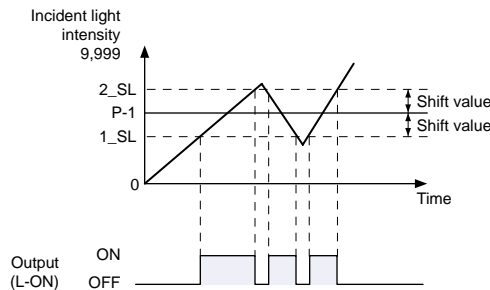

2-level Teaching P. 15

This carries out 2-level teaching (P-1, P-2) and sets the threshold values (1_SL, 2_SL).

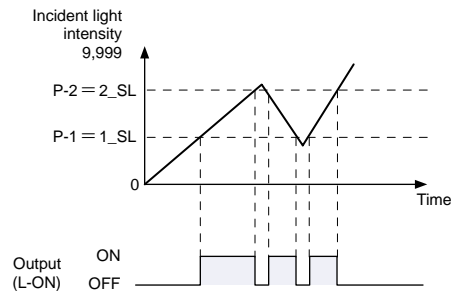

* In this figure, the incident light intensity of P-1 is less than that of P-2.

3-level Teaching P. 16 ~

This carries out 3-level teaching (P-1, P-2, P-3) and sets the threshold value (1_SL) between A and B and the threshold value (2_SL) between B and C as shown in the diagram below.

After teaching, P-1, P-2 and P-3 are automatically assigned in ascending order to 'A', 'B', and 'C'.

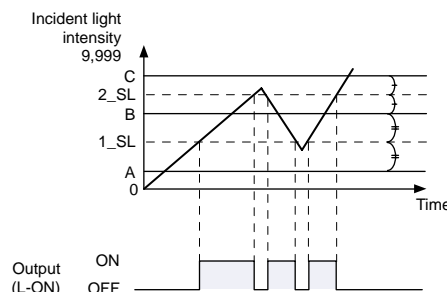

TEACH : Teaching Mode

Refer to p. 18 ~ for setting procedure

When using hysteresis mode

This sets the ON / OFF levels with any of the 3 teaching methods ('1-level teaching', '2-level teaching' and '3-level teaching') and sets the hysteresis. By adjusting the hysteresis, the irregular sections of sensing objects with irregularities are canceled out so that stable sensing is possible.

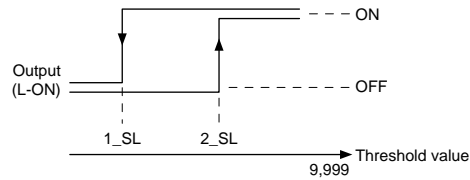

1-level Teaching P. 18

This sets the shift value to any desired value, and sets the ON level / OFF level (1_SL, 2_SL) by means of 1-level teaching (P-1).

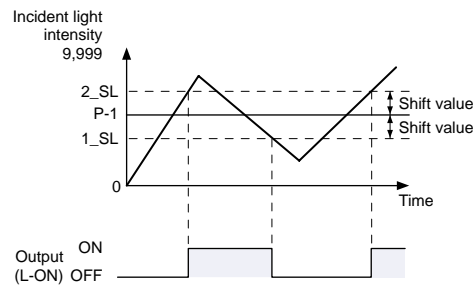

2-level Teaching P. 19

This carries out 2-level teaching (P-1, P-2) and sets the ON level / OFF level (1_SL, 2_SL).

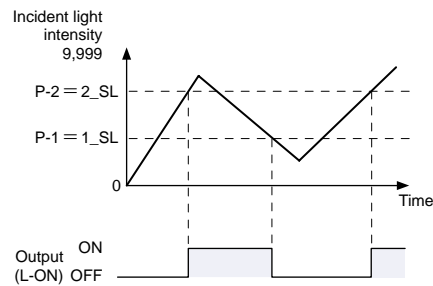

* In this figure, the incident light intensity of P-1 is less than that of P-2.

3-level Teaching P. 20 ~

This carries out 3-level teaching (P-1, P-2, P-3) and sets the ON level / OFF level (1_SL, 2_SL) between A and B as shown in the diagram below.

After teaching, P-1, P-2 and P-3 are automatically assigned in ascending order to 'A', 'B', and 'C'.

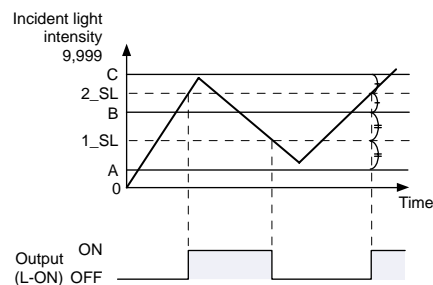

TEACH : Teaching Mode

When using differential (rising or trailing) mode

Only sudden changes in the light intensity are sensed, so that objects such as glass edges can also be sensed with stability.

Span adjustment during differential mode

When setting differential mode in PRO mode, the maximum sensitivity (minimum threshold value) is set.

If the response time is changed in differential mode, the maximum sensitivity (minimum threshold value) for that response time is set automatically.

Span adjustment for differential mode can be set as follows in teaching mode. The threshold value can be changed using the threshold value fine adjustment function. Refer to 'threshold value fine adjustment function (P. 6)' for details.

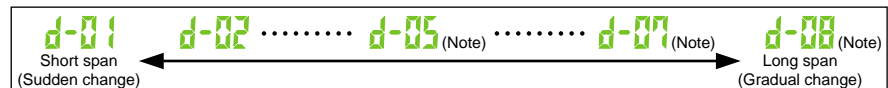
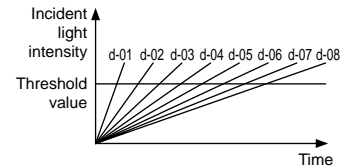

* Products manufactured up until June 2004 (~ Lot No.: 4F□) are set in 5 steps (d-01 to d-05).



L/D ON : Output Operation Setting Mode

Refer to p. 22 for setting procedure

This mode allows the selection of output operation from either Light-ON, or Dark-ON.

When using normal mode

When set to 'L-ON', the output will be ON if the incident light intensity becomes greater than the 'threshold value'.

When set to 'D-ON', the output will be ON if the incident light intensity becomes less than the 'threshold value'.

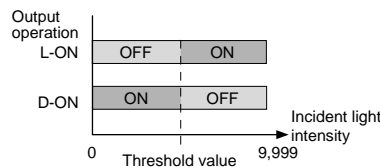

When using window comparator mode

When set to 'L-ON', if the incident light intensity is between the two 'threshold value' levels, the output will be ON. If the incident light intensity is outside of the two threshold value levels, the output will be OFF.

When set to 'D-ON', if the incident light intensity is between the two 'threshold value' levels, the output will be OFF. If the incident light intensity is outside of the two threshold value levels, the output will be ON.

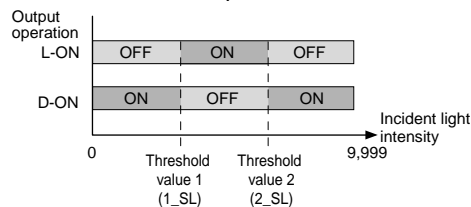

* The factory setting is 'L-ON (Light-ON)'.

When using hysteresis mode

For L-ON, the output turns ON when the incident light intensity is greater than the ON level (2_SL), and the output turns OFF when the incident light intensity is less than the OFF level (1_SL).

For D-ON, the output turns OFF when the incident light intensity is greater than the OFF level (2_SL), and the output turns ON when the incident light intensity is less than the ON level (1_SL).

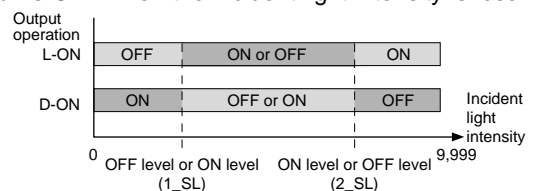

When using rising differential mode

For L-ON, output is ON for a constant period of time when the incident light intensity is rising.

For D-ON, output is OFF for a constant period of time when the incident light intensity is rising.

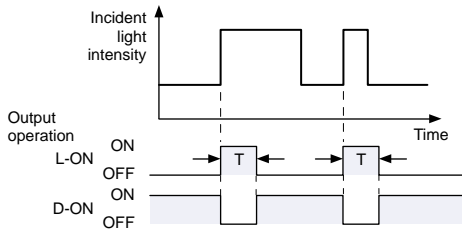

When using trailing differential mode

For L-ON, output is ON for a constant period of time when the incident light intensity is trailing.

For D-ON, output is OFF for a constant period of time when the incident light intensity is trailing.

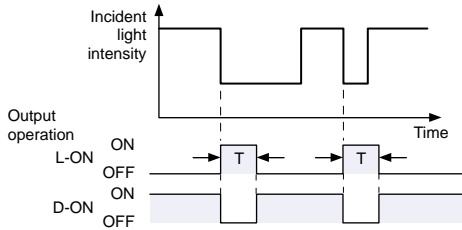

TIMER : Timer Setting Mode

Refer to p. 23 for setting procedure

This sets timer operation and the timer period. The setting can be selected from Without timer / OFF-delay / ON-delay / ONE-SHOT timer. The factory setting is 'Without timer'.

Timer period: Approx. 1 to 9,999 ms

* When using rising / trailing differential mode, the timer is set automatically to ONE-SHOT timer.

* For products manufactured up until June 2004 (~ Lot No.: 4F□) timer modes other than ONE-SHOT timer cannot be used in differential modes.

Time chart

Timer operation	Output operation	Sensing condition	Beam-received / Beam-interrupted
Without Timer	Light-ON	[Sensing condition diagram]	ON / OFF
	Dark-ON	[Sensing condition diagram]	ON / OFF
ON-delay	Light-ON	[Sensing condition diagram]	ON / OFF
	Dark-ON	[Sensing condition diagram]	ON / OFF
OFF-delay	Light-ON	[Sensing condition diagram]	ON / OFF
	Dark-ON	[Sensing condition diagram]	ON / OFF
ONE-SHOT	Light-ON	[Sensing condition diagram]	ON / OFF
	Dark-ON	[Sensing condition diagram]	ON / OFF

Timer period T₁ = Approx. 1 ms to 9,999 ms

* OFF-delay: Extends the output signal for a fixed period of time. This function is useful if the output signal is so short that the connected device cannot respond.

ON-delay: Neglects short output signals. As only long signals are extracted, this function is useful for detecting if a line is clogged, or for sensing only objects taking a long time to travel.

ONE-SHOT: Outputs a fixed width signal upon sensing. This function is useful when the input specifications of the connected device require a signal of fixed width. Of course, it is also useful for extending a short width signal to a desired width.

CUST : CUSTOM Mode

This is used to make detailed settings for functions selected in PRO5 mode. Out of the response time change function, M.G.S. function, emission halt function, data bank function and code setting function, one of these functions selected in PRO5 mode can be set in detail. Refer to the pages for each function for details on the setting methods.

4-2. Teaching Mode (when using normal mode)

The 'threshold value' can be set by utilizing three kinds of teaching, whichever '2-level teaching', 'limit teaching' or 'full-auto teaching'.

* Select output 1 and output 2 and the sensing mode beforehand.

2-level Teaching

2-level teaching is a method of setting the 'threshold value' by teaching the amplifier two different status conditions - sensing object present and sensing object absent. The 'threshold value' is usually set using this method.

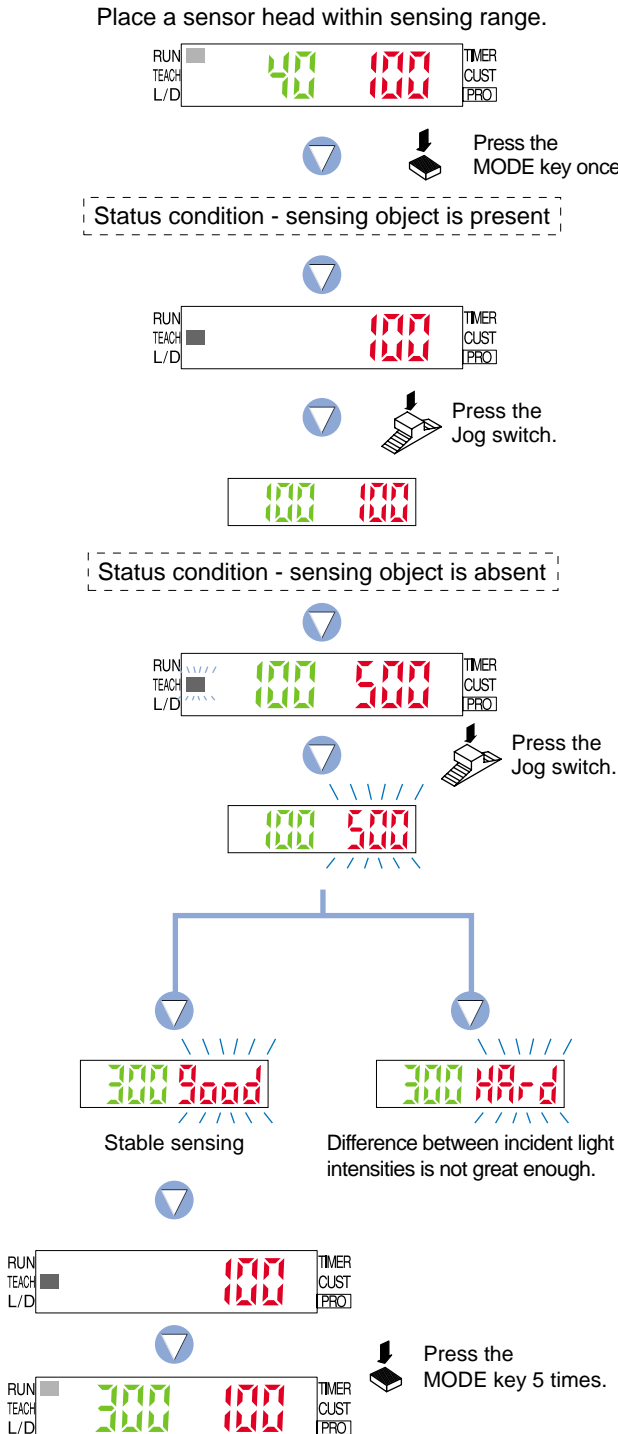

- ① Select 'TEACH mode' by pressing the [MODE key] once.
- ② Press the [Jog switch] when in the status condition of - sensing object is present.
- ③ The digital display will indicate the incident light intensity reading (green), then the MODE indicator / TEACH (yellow) will blink.
(This indicates that the second point item is now ready for input.)
- ④ Press the [Jog switch] when in the status condition of - sensing object is absent.
- ⑤ The digital display will again blink the incident light intensity reading (red) and the 'threshold value' will be set to a value midway between the incident light intensities when the sensing object is present and when it is absent. The blinking MODE indicator / TEACH will stop blinking and continuously light up.
* Fine adjustment of the 'threshold value' can be performed in the RUN mode.
- ⑥ The set 'threshold value' (green) will indicate and the sensing stability status will be displayed.
 - When stable sensing can be performed
→ The digital display will blink the word 'Good' (red).
 - When stable sensing cannot be performed
→ The digital display will blink the word 'Bad' (red).
- ⑦ The incident light intensity (red) will again be displayed, indicating that configuration is now complete.
- ⑧ By pressing the [MODE key] 5 times, the amplifier will return to 'RUN mode' (normal sensing operation).

Limit Teaching

Teaches only the status condition in which no sensing object is within sensing range (status in which incident light intensity is stable). This method is used to set a 'threshold value' for conducting sensing in the presence of a background, or when extremely small objects are to be detected.

Place a sensor head within sensing range.



Press the MODE key once.

Status condition - sensing object is absent



Press the Jog switch.



Turn the Jog switch in the '+' or '-' direction.



The digital display will scroll.

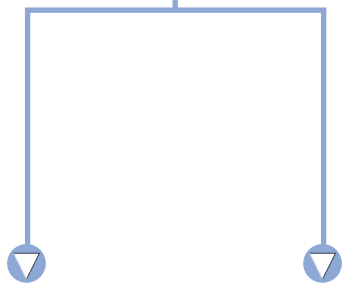

Shifting can be performed.

Shifting cannot be performed.



Press the MODE key 5 times.



① Select 'TEACH mode' by pressing the [MODE key] once.

② Press the [Jog switch] when in the status condition of - sensing object is absent.

③ The digital display will indicate the incident light intensity reading (green), then the MODE indicator / TEACH (yellow) will blink.

④ Turn the [Jog switch] in either the '+' or '-' direction.

When using retroreflective type sensor head

- If the switch is turned toward the '-' direction, the digital display will scroll from the left to the right and the threshold value will be shifted down by approx. 15 %, to a value lower than the incident light intensity displayed (high sensitivity).

When using reflective type sensor head

- If the switch is turned toward the '+' direction, the digital display will scroll from the right to the left and the threshold value will be shifted up by approx. 15 %, to a value higher than the incident light intensity displayed (low sensitivity).

* The initial factory-set value of the shift amount is approx. 15 %.

The shift amount can be changed by utilizing the '5-4. Shift Function' from 'PRO1 Mode', described on p. 27. (The percentage adjustment is variable from approx. 5 % to 200 %, in increments of 1 %.)

⑤ The set 'threshold value' (green) will indicate and the judgement on whether the shift amount can be shifted or not will be displayed.

- When the shifting can be performed

→ The digital display will blink the word 'Good'.

- When the shift amount cannot be changed because the setting exceeds the upper or lower display limit (the value is reset to within the upper and lower limits)

→ The digital display will blink the word 'H-d'.

⑥ The incident light intensity (red) will again be displayed, indicating that configuration is now complete.

⑦ By pressing the [MODE key] 5 times, the amplifier will return to 'RUN mode' (normal sensing operation).

Full-Auto Teaching

Full-auto teaching is used to set the threshold value while the sensing objects are still moving on the production line, without stopping the production line.

Place a sensor head within sensing range.



Press the MODE key once.



Status condition-moving the production line

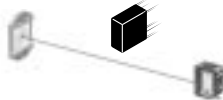

Hold down the Jog switch.

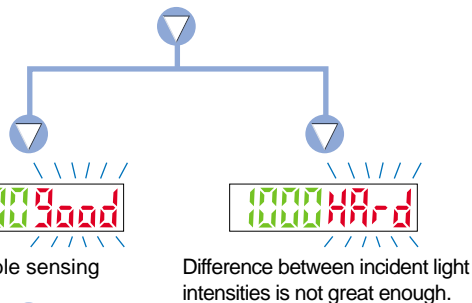

Press the MODE key 5 times.



① Select 'TEACH mode' by pressing the [MODE key] once.

② Hold down the [Jog switch] for 0.5 sec. or more when in the status condition when the object moving on the production line.

③ 'Auto' (green) is displayed on the digital display, then the MODE indicator / TEACH (yellow) will blink. Release the jog switch when the object has passed.

④ Incident light intensity (red) will blink on the digital display, and the 'threshold value' will be set to a value midway between the incident light intensities when the sensing object is present and when it is absent.

⑤ The set 'threshold value' (green) will indicate and the judgement on the stability of sensing will be displayed.

- When stable sensing can be performed
→ The digital display will blink the word '900' (red).
- When stable sensing cannot be performed
→ The digital display will blink the word 'H-d' (red).

⑥ The incident light intensity (red) will again be displayed, indicating that configuration is now complete.

⑦ By pressing the [MODE key] 5 times, the amplifier will return to 'RUN mode' (normal sensing operation).

4-3. Teaching Mode (when using window comparator mode)

The 'threshold value' can be set using '1-level teaching', '2-level teaching' or '3-level teaching'. In window comparator mode, teaching is performed using the teaching methods described in the section entitled '10-2. Output 1 Sensing Mode Settings' from 'PRO6 Mode' on p. 53.

Change the teaching method using '10-2. Output 1 Sensing Mode Settings' from 'PRO6 Mode' on p. 53 beforehand.

* Window comparator mode can be set done for output 1 only.

* The factory setting is '1-level teaching'.

1-level Teaching

This is the method of setting the threshold values (1_SL, 2_SL) by one level (P-1) teaching. The shift value can be set as desired.

* The shift value units can be selected from two units: 'digit' or '%'.

* The shift value of the factory setting is set to '100' of 'digit' units.

To set the shift value, refer to the section entitled '10-2. Output 1 Sensing Mode Settings' from 'PRO6 Mode' on p. 53.

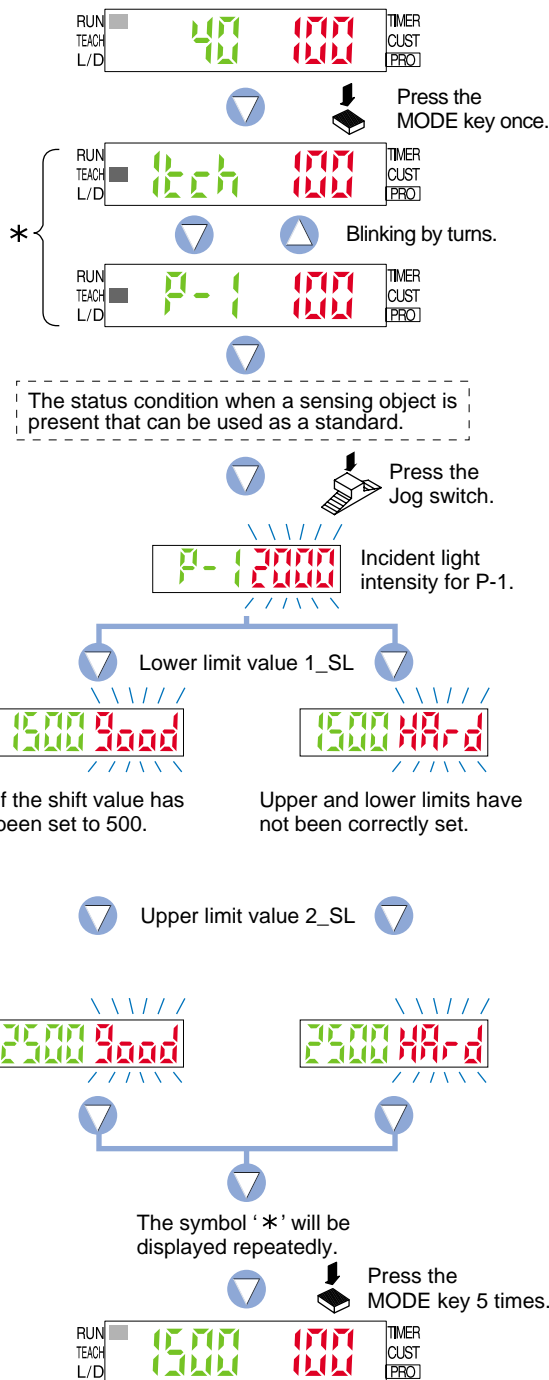
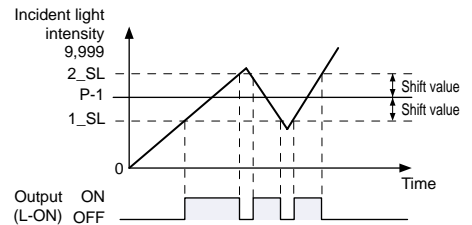

- ① Select 'TEACH mode' by pressing the [MODE key] once.
- ② The current teaching method (green) and incident light intensity (red) will be displayed and the amplifier will enter the 'P-1' setting state.
- ③ If the [Jog switch] is pressed while in the status condition when a sensing object is present that can be used as a standard, then the display will blink the incident light intensity reading (red).
- ④ The display will indicate whether the upper and lower threshold value limits have been correctly set and the setting for 'lower limit value 1_SL' (green) will be displayed.
 - If 'Good' (red) is blinking...the upper and lower limits have been set correctly.
 - If 'Bad' (red) is blinking...the upper and lower limits have not been set correctly.

* The shift value of the factory setting is set to '100' of 'digit' units.
To set the shift value, refer to the section entitled '10-2. Output 1 Sensing Mode Settings' from 'PRO6 Mode' on p. 53.
- ⑤ Then the setting for 'upper limit value 2_SL' (green) will be displayed.
- ⑥ By pressing the [MODE key] 5 times, the amplifier will return to 'RUN mode' (normal sensing operation). 'Lower limit value 1_SL' (green) and incident light intensity (red) will be displayed.

2-level Teaching

This is a method of setting the threshold values (1_SL, 2_SL) by two levels (P-1, P-2) teaching.

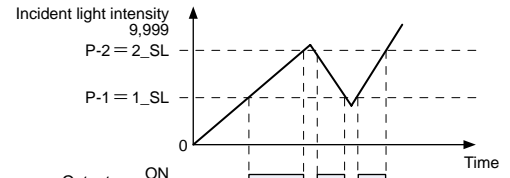
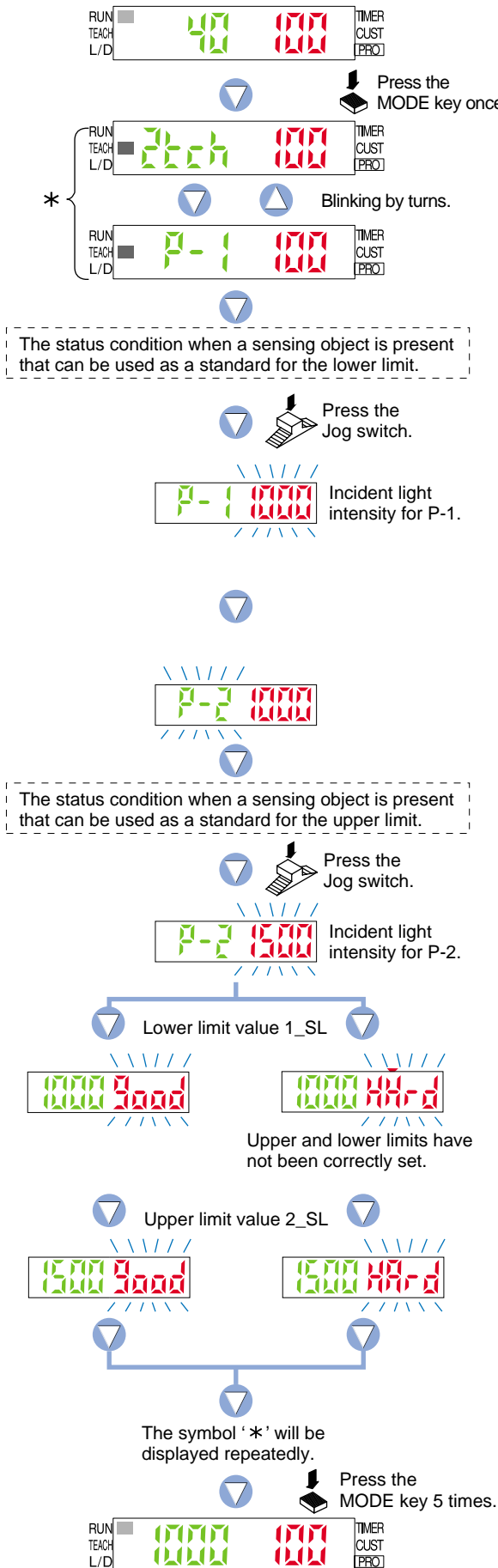

- ① Select 'TEACH mode' by pressing the [MODE key] once.
- ② The current teaching method (green) and incident light intensity (red) will be displayed and the amplifier will enter the 'P-1' setting state.
 - When using retroreflective type sensor head
 - Press the [Jog switch] for the sensing object that has the greatest amount of interrupted light.
 - When using reflective type sensor head
 - Press the [Jog switch] for the sensing object with the lowest intensity of incident light.
- Note) Even if procedures ③ and ⑤ are reversed, teaching for a sensing object with low intensity incident light will automatically cause the setting of 'lower limit value 1_SL'.
- ③ If the [Jog switch] is pressed while in the status condition when a sensing object is present that can be used as a standard for the lower limit, then the display will blink and indicate the incident light intensity reading (red).
- ④ The amplifier has entered the 'P-2' setting state and 'P-2' (green) will blink.
- ⑤ If the [Jog switch] is pressed while in the status condition when a sensing object is present that can be used as a standard for the upper limit, then the display will blink the incident light intensity reading (red).
 - When using retroreflective type sensor head
 - Press the [Jog switch] for the sensing object that has the least amount of interrupted light.
 - When using reflective type sensor head
 - Press the [Jog switch] for the sensing object with the greatest incident light intensity.
- ⑥ The display will indicate whether the upper and lower limits have been correctly set and the setting for 'lower limit value 1_SL' (green) will be displayed.
 - If '9000' (red) is blinking...the upper and lower limits have been set correctly.
 - If 'HH-d' (red) is blinking...the upper and lower limits have not been set correctly.
- ⑦ Then the setting for 'upper limit value 2_SL' (green) will be displayed.
- ⑧ By pressing the [MODE key] 5 times, the amplifier will return to 'RUN mode' (normal sensing operation). 'Lower limit value 1_SL' (green) and incident light intensity (red) will be displayed.

3-level Teaching

This is a method of setting the threshold range by three levels (P-1, P-2, P-3) teaching and set the threshold values at the middle of 'A' and 'B' (1_SL) and 'B' and 'C' (2_SL).

After teaching, P-1, P-2 and P-3 are automatically assigned in ascending order to 'A', 'B', and 'C'.

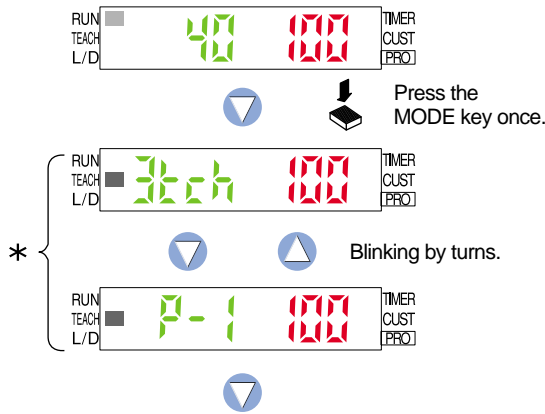
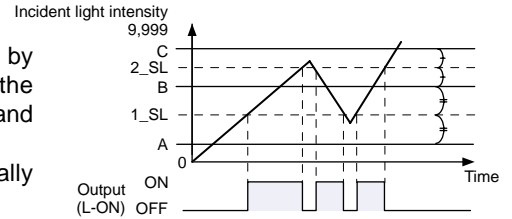

The status condition when sensing object 'A' is present that has the lowest intensity of incident light.

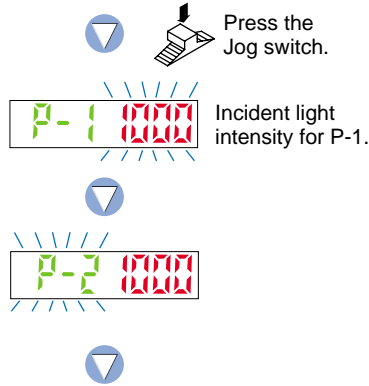

The status condition when sensing object 'B' is present that has an incident light intensity in between that of sensing object 'A' and sensing object 'C'.

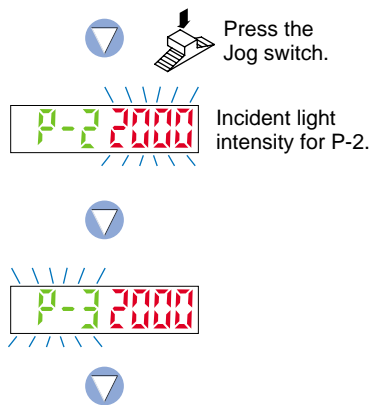

- ① Select 'TEACH mode' by pressing the [MODE key] once.
- ② The current teaching method (green) and incident light intensity (red) will be displayed and the amplifier will enter the 'P-1' setting state.
- ③ If the [Jog switch] is pressed while in the status condition when sensing object 'A' is present that has the lowest intensity of incident light, then the display will blink the incident light intensity reading (red).
- ④ The amplifier has entered the 'P-2' setting state and 'P-2' (green) will blink.
- ⑤ If the [Jog switch] is pressed while in the status condition when sensing object 'B' is present that has an incident light intensity in between that of sensing object 'A' and sensing object 'C', the display will blink the incident light intensity reading (red).
- ⑥ The amplifier has entered the 'P-3' setting state and 'P-3' (green) will blink.

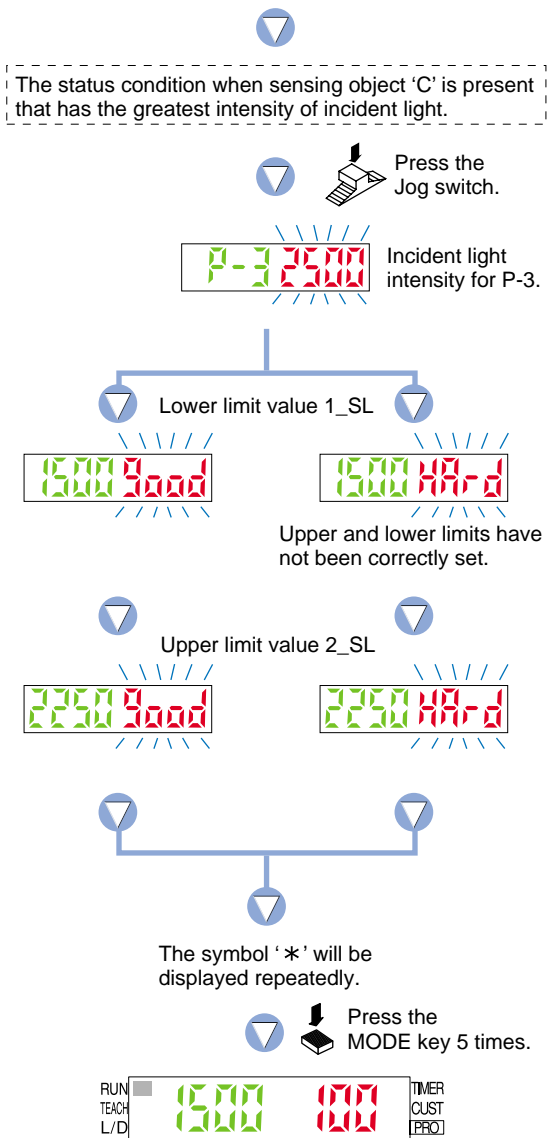

- ⑦ If the [Jog switch] is pressed while in the status condition when sensing object 'C' is present that has the greatest intensity of incident light, the display will blink the incident light intensity reading (red).

- ⑧ The display will indicate whether the upper and lower limits have been correctly set and the setting for 'lower limit value 1_SL' (green) will be displayed.
 - If '9000' (red) is blinking...the upper and lower limits have been set correctly.
 - If 'HA-d' (red) is blinking...the upper and lower limits have not been set correctly.

- ⑨ Then the setting for 'upper limit value 2_SL' (green) will be displayed.

- ⑩ By pressing the [MODE key] 5 times, the amplifier will return to 'RUN mode' (normal sensing operation). 'Lower limit value 1_SL' (green) and incident light intensity (red) will be displayed.

4-4. Teaching Mode (when using hysteresis mode)

The 'ON Level / OFF Level' can be set using '1-level teaching', '2-level teaching' or '3-level teaching'. In hysteresis mode, teaching is performed using the teaching methods described in the section entitled '10-2. Output 1 Sensing Mode Settings' from 'PRO6 Mode' on p. 53

Change the teaching method using '10-2. Output 1 Sensing Mode Settings' from 'PRO6 Mode' on p. 53 beforehand.

* Hysteresis mode can be set for output 1 only.

* The factory setting is '1-level teaching'.

1-level Teaching

This is the method of setting the ON Level / OFF Level (1_SL, 2_SL) by one level (P-1) teaching. The shift value can be set as desired.

* The shift value units can be selected from two units: 'digit' or '%'.
 * The shift value of the factory setting is set to '100' of 'digit' units.

To set the shift value, refer to the section entitled '10-2. Output 1 Sensing Mode Settings' from 'PRO6 Mode' on p. 53.

To set the shift value, refer to the section entitled '10-2. Output 1 Sensing Mode Settings' from 'PRO6 Mode' on p. 53.

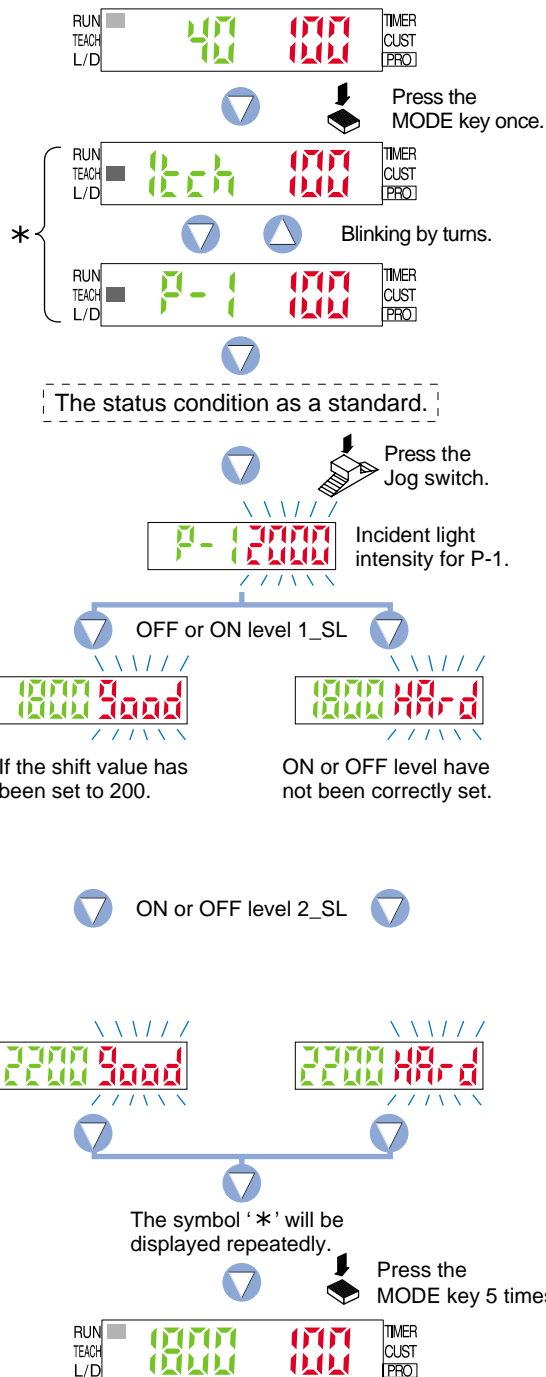
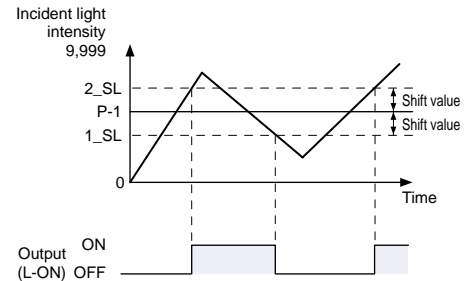

- ① Select 'TEACH mode' by pressing the [MODE key] once.
- ② The current teaching method (green) and incident light intensity (red) will be displayed and the amplifier will enter the 'P-1' setting state.
- ③ If the [Jog switch] is pressed while in the status condition as a standard, then the display will blink the incident light intensity reading (red).
- ④ The display will indicate whether the ON and OFF level have been correctly set and the setting for 'OFF or ON level 1_SL' (green) will be displayed.
 - If '000' (red) is blinking...the ON and OFF level have been set correctly.
 - If '9999' (red) is blinking...the ON and OFF level have not been set correctly.

* The shift value of the factory setting is set to '100' of 'digit' units.
 To set the shift value, refer to the section entitled '10-2. Output 1 Sensing Mode Settings' from 'PRO6 Mode' on p. 53.
- ⑤ Then the setting for 'ON or OFF level 2_SL' (green) will be displayed.
- ⑥ By pressing the [MODE key] 5 times, the amplifier will return to 'RUN mode' (normal sensing operation). 'OFF or ON level 1_SL' (green) and incident light intensity (red) will be displayed.

2-level Teaching

This is a method of setting the ON level / OFF level (1_SL, 2_SL) by two levels (P-1, P-2) teaching.

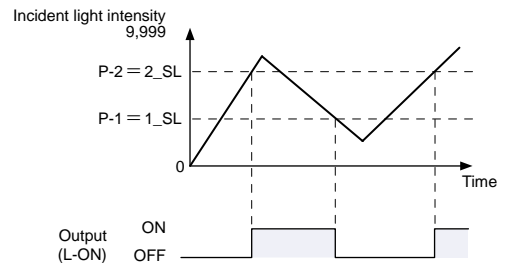
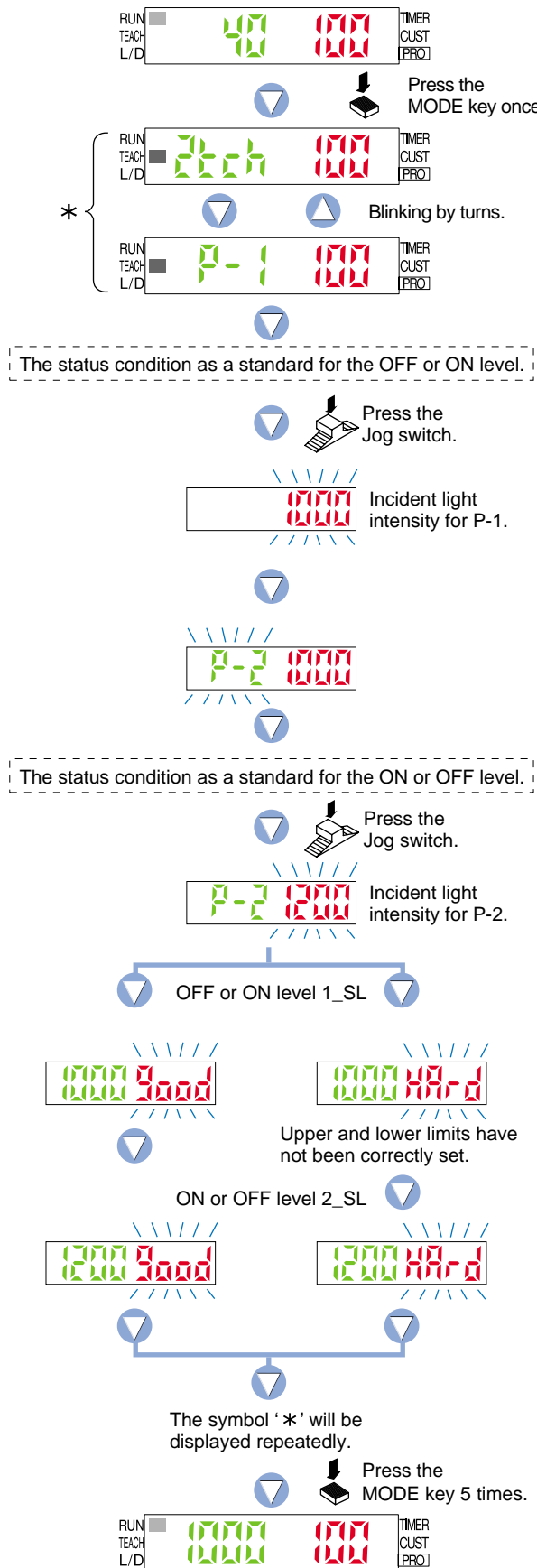

- ① Select 'TEACH mode' by pressing the [MODE key] once.
- ② The current teaching method (green) and incident light intensity (red) will be displayed and the amplifier will enter the 'P-1' setting state.
- ③ If the [Jog switch] is pressed while in the status condition as a standard for the OFF level or ON level, then the display will blink the incident light intensity reading (red).
 - When using retroreflective type sensor head
 - Press the [Jog switch] when the interrupted light is the greatest amount.
 - When using reflective type sensor head
 - Press the [Jog switch] when the incident light is the lowest intensity.

Note) Even if procedures ③ and ⑤ are reversed, teaching in condition of low intensity of incident light will automatically cause the setting of 'OFF level or ON level 1_SL'.
- ④ The amplifier has entered the 'P-2' setting state and 'P-2' (green) will blink.
- ⑤ If the [Jog switch] is pressed while in the status condition as a standard for the ON level or OFF level, then the display will blink the incident light intensity reading (red).
 - When using retroreflective type sensor head
 - Press the [Jog switch] when the interrupted light is the least amount.
 - When using reflective type sensor head
 - Press the [Jog switch] when the incident light is the greatest intensity.
- ⑥ The display will indicate whether the ON and OFF level have been correctly set and the setting for 'OFF or ON level 1_SL' (green) will be displayed.
 - If '9.00' (red) is blinking...the ON and OFF level have been set correctly.
 - If '99.9' (red) is blinking...the ON and OFF level have not been set correctly.
- ⑦ Then the setting for 'ON or OFF level 2_SL' (green) will be displayed.
- ⑧ By pressing the [MODE key] 5 times, the amplifier will return to 'RUN mode' (normal sensing operation). 'OFF or ON level 1_SL' (green) and incident light intensity (red) will be displayed.

3-level Teaching

This is a method of setting the ON and OFF range by three levels (P-1, P-2, P-3) teaching and set the OFF level or ON level at the middle of 'A' and 'B' (1_SL) and set the ON level or OFF level at the middle of 'B' and 'C' (2_SL).

After teaching, P-1, P-2 and P-3 are automatically assigned in ascending order to 'A', 'B', and 'C'.

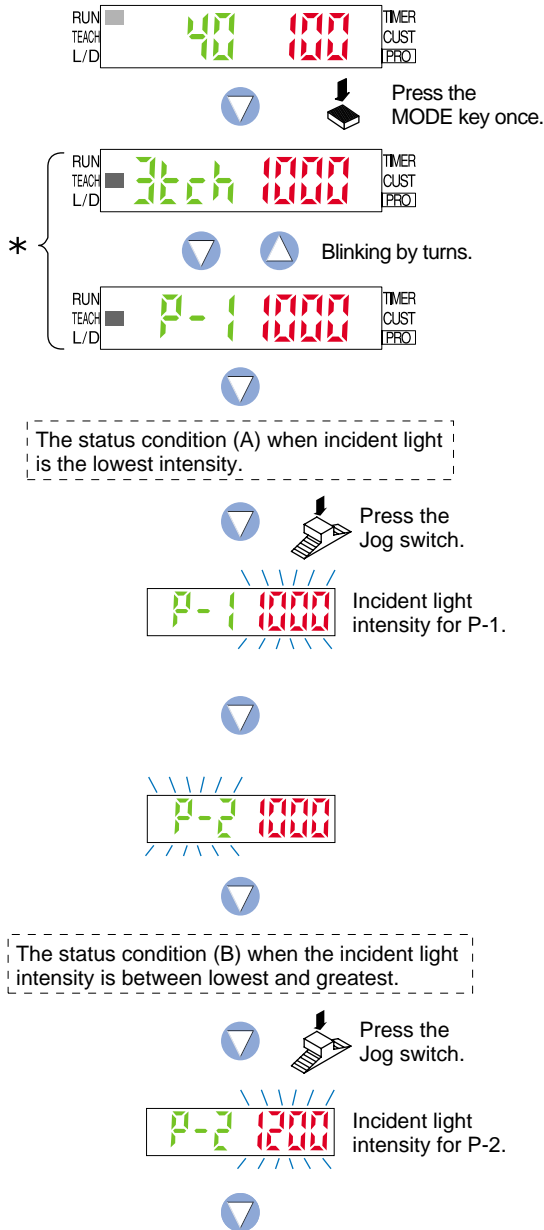
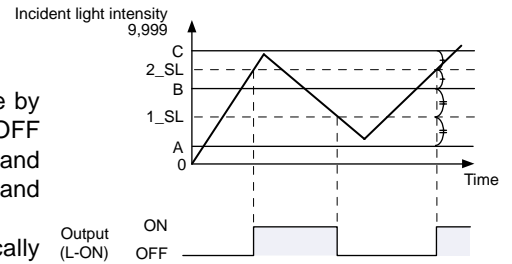

- ① Select 'TEACH mode' by pressing the [MODE key] once.
- ② The current teaching method (green) and incident light intensity (red) will be displayed and the amplifier will enter the 'P-1' setting state.
- ③ If the [Jog switch] is pressed while in the status condition (A) when the incident light is the lowest intensity, then the display will blink the incident light intensity reading (red).
- ④ The amplifier has entered the 'P-2' setting state and 'P-2' (green) will blink.
- ⑤ If the [Jog switch] is pressed while in the status condition (B) when the incident light intensity is between lowest and greatest, the display will blink the incident light intensity reading (red).

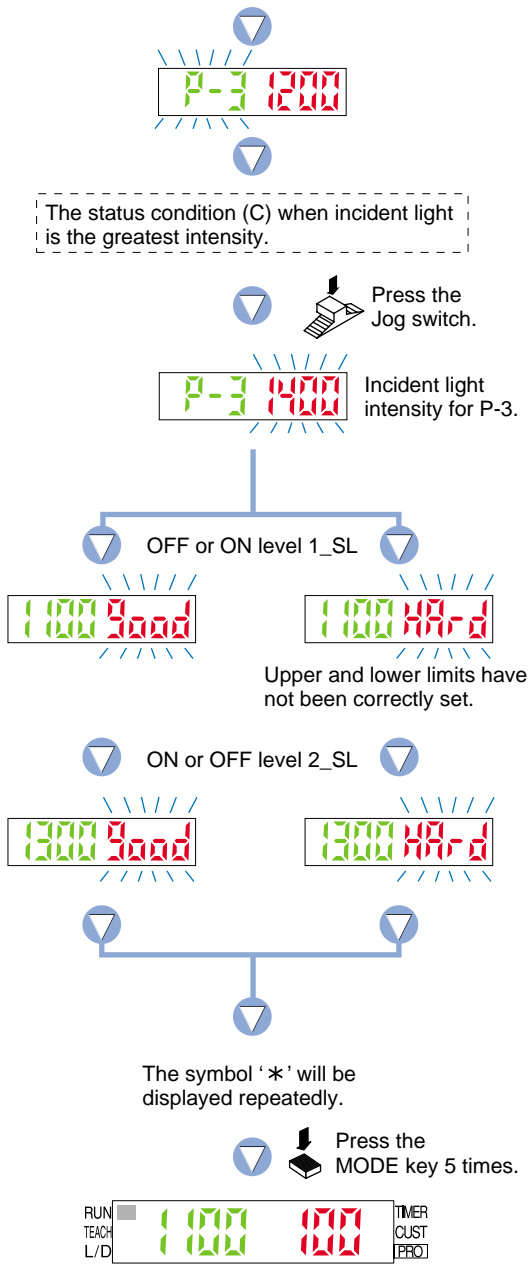

- ⑥ The amplifier has entered the 'P-3' setting state and 'P-3' (green) will blink.
- ⑦ If the [Jog switch] is pressed while in the status condition (C) when the incident light is the greatest intensity, then the display will blink and indicate the incident light intensity reading (red).
- ⑧ The display will indicate whether the ON and OFF level have been correctly set and the setting for 'OFF or ON level 1_SL' (green) will be displayed.
 - If '900d' (red) is blinking...the ON and OFF level have been set correctly.
 - If 'HA-d' (red) is blinking...the ON and OFF level have not been set correctly.
- ⑨ Then the setting for 'ON or OFF level 2_SL' (green) will be displayed.
- ⑩ By pressing the [MODE key] 5 times, the amplifier will return to 'RUN mode' (normal sensing operation). 'OFF or ON level 1_SL' (green) and incident light intensity (red) will be displayed.

4-5. Output Operation Setting Mode

This mode allows the selection of output operation from either L-ON (Light-ON), or D-ON (Dark-ON).

* Select the output 1 or output 2 beforehand.

Output operation

Normal mode

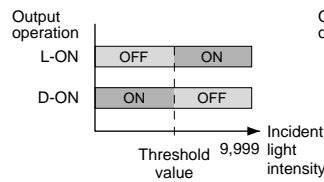

Window comparator mode

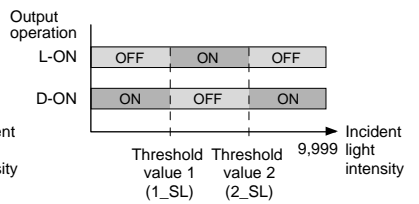

Hysteresis mode

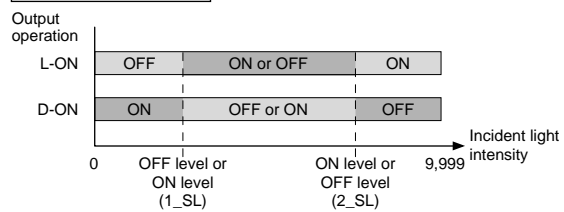

When setting rising differential mode

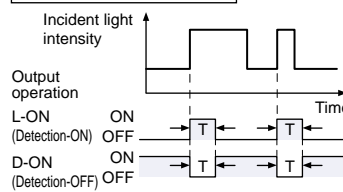

When setting trailing differential mode

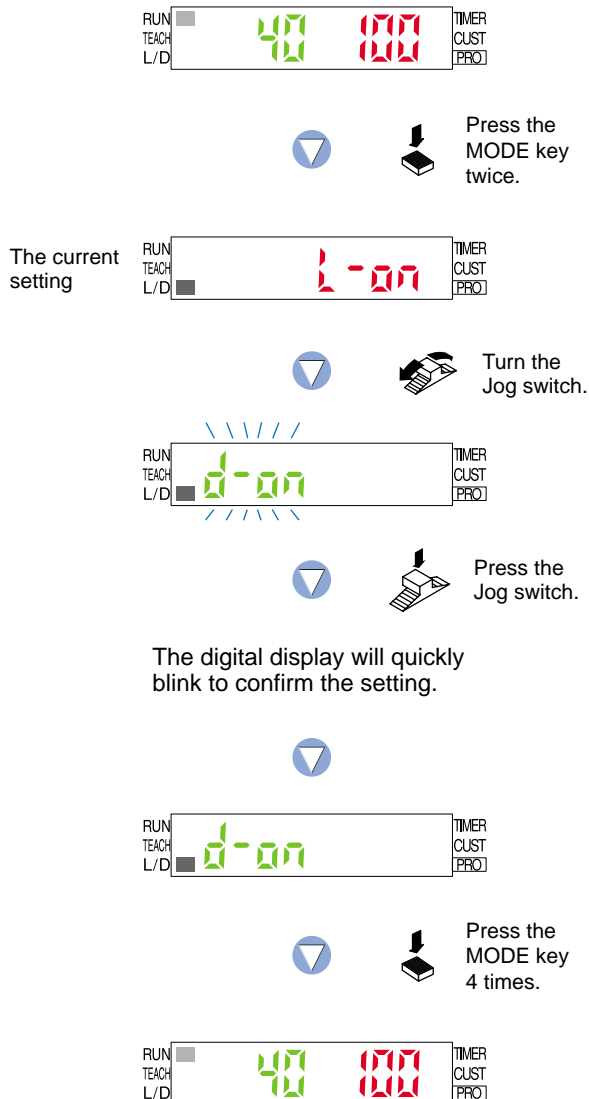
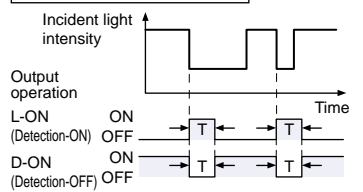

- ① Press the [MODE key] twice to select the 'output operation setting mode'.
- ② The current setting for output operation will be displayed.
* The factory setting is 'L-ON (Light-ON)'.
- ③ If the [Jog switch] is turned, the setting for output operation ('+' side... 00-00 '-' side... 1-00) will blink on the digital display.
- ④ If the [Jog switch] is pressed, output operation will quickly blink on the digital display and the selected 'output operation' will be confirmed.
(The digital display will not blink if the setting has not been changed).
- ⑤ Press the [MODE key] 4 times, the amplifier will return to 'RUN mode' (normal sensing operation).

4-6. Timer Setting Mode

This mode sets the timer operation and timer period.
The factory setting is 'Without timer'.

The setting can be selected from Without timer / OFF-delay / ON-delay / ONE-SHOT timer.

Timer period: Can be set to between approx. 1 to 9,999 ms in units of 1 ms.

* Select the output 1 and output 2 beforehand.

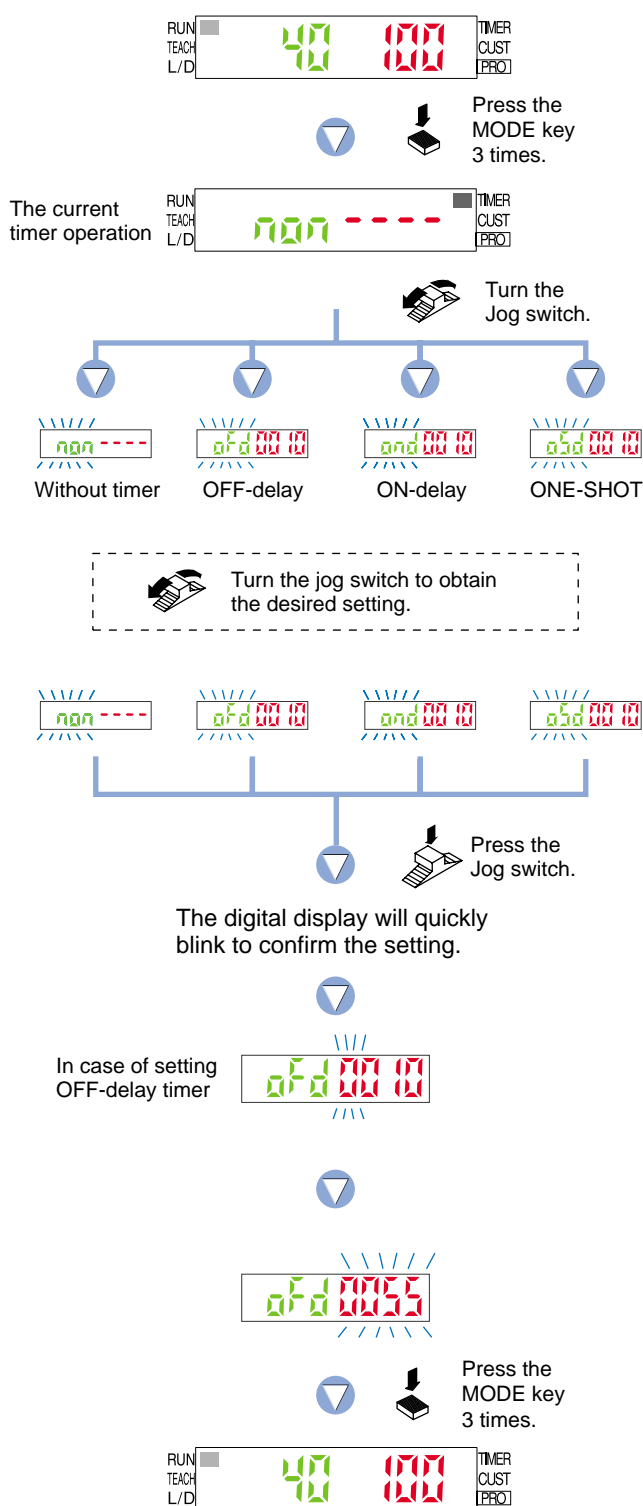

- ① Press the [MODE key] 3 times to select the 'timer setting mode'.
- ② The current setting will be displayed.
If the [Jog switch] is turned, the digital display will blink.
* The factory setting is 'Without timer'.
* If timer operation has already been set (except for Without timer), the display moves to the timer period setting (⑤) when you press the jog switch.
- ③ Turn the [Jog switch] to obtain the desired setting for timer operation.
* When using rising / trailing differential mode, the timer is set automatically to ONE-SHOT timer.
* For products manufactured up until June 2004 (~ Lot No.: 4F□) timer modes other than ONE-SHOT timer cannot be used in rising / trailing differential modes.
- ④ If the [Jog switch] is pressed, timer operation (green) will quickly blink on the digital display and the selected 'timer operation' will be confirmed.
(The digital display will not blink (green) if the setting has not been changed.)
- ⑤ Set the timer period starting from the 1st digit.
Turn the [Jog switch] to set the timer period for the digit that is blinking.
* The factory setting is '10 ms'.
* If you do not want to change the timer period, you can press the MODE key to cancel the setting. (Timer operation is enabled.)
- ⑥ When all digits have been set, if the jog switch is pressed, the timer period that has been set will quickly blink (red) and the timer period will be confirmed.
- ⑦ Press the [MODE key] 3 times, the amplifier will return to 'RUN mode' (normal sensing operation).

5 PRO1 Mode

5-1. PRO1 Mode Functions and Settings

PRO1 mode is used mainly for configuring the details of basic settings.

* Output 1 and output 2 will both be changed to the same settings.

The settings can be carried out in either output 1 mode or output 2 mode.

SPED : Response Time Change Function

Refer to p. 25 for setting procedure

The response times for the **LS-400** series can be switched among four levels: H-SP (ultra high-speed), FAST (high-speed), STD (standard) and U-LG (ultra long-range). The switching of response times among these four levels will cause corresponding changes to the sensing range.

* The factory setting is 'STD (standard)'.

Setting	Response time
H-SP (ultra high-speed)	80 μ s (0.08 ms) or less
FAST (high-speed)	150 μ s (0.15 ms) or less
STD (standard)	500 μ s (0.5 ms) or less
U-LG (ultra long-range)	4 ms or less

HYS : Hysteresis Function

Refer to p. 26 for setting procedure

The hysteresis can be switched to one of three settings (small / standard / large) in all sensing modes except for hysteresis mode.

* The factory setting is 'H-02 (standard)'.

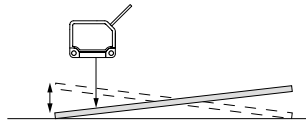

- * H-01 (small) : The optimal limit of detection range
- H-02 (standard) : Standard
- H-03 (large) : Capability of detecting sensing objects having a vibratory motion

SHFT : Shift Function

Refer to p. 27 for setting procedure

Limit Teaching

Shifts the 'threshold value' by a certain percentage increment during 'limit teaching'. (The percentage adjustment is variable from approx. 5 % to 200 %, in increments of 1 %).

* The factory setting is '15 % approx'.

When utilizing reflective type sensor head:

If the threshold value is shifted toward the '+' direction, minute and severe detections become possible.

When utilizing retroreflective type sensor head:

If the threshold value is shifted toward the '-' direction, minute and severe detections become possible.

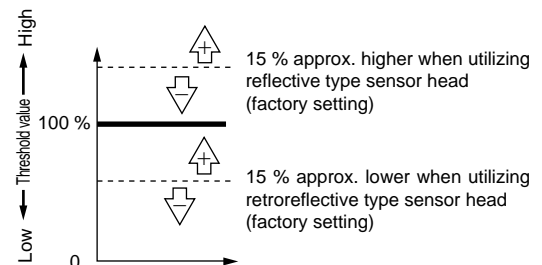

The threshold value is variable from approx. 5 % to 200 % (in increments of 1 %).

REEL : M.G.S. Function

Refer to p. 28 for setting procedure

The receiving light sensitivity can be set in three steps (four steps for U-LG mode only).

LASE : Emission Halt Function

Refer to p. 29 for setting procedure

This selects whether the laser is emitted or not.

5-2. Response Time Change Function

Response time can be switched among four levels: H-SP (ultra high-speed) / FAST (high-speed) / STD (standard) / U-LG (ultra long-range).

* The incident light intensity display can display a maximum value of 4,000 in H-SP (ultra high-speed) mode and FAST (high-speed) mode. In STD (standard) mode and U-LG (ultra long-range) mode, it can display up to a maximum value of 9,999.

* In H-SP mode, the interference prevention / copy / single step load / single step save functions cannot be used. After making settings in H-SP mode and using the copy function or another function in a different mode, turn the power off and then back on again.

Setting	Response time
H-SP (ultra high-speed)	80 μ s (0.08 ms) or less
FAST (high-speed)	150 μ s (0.15 ms) or less
Std (standard)	500 μ s (0.5 ms) or less
U-LG (ultra long-range)	4 ms or less

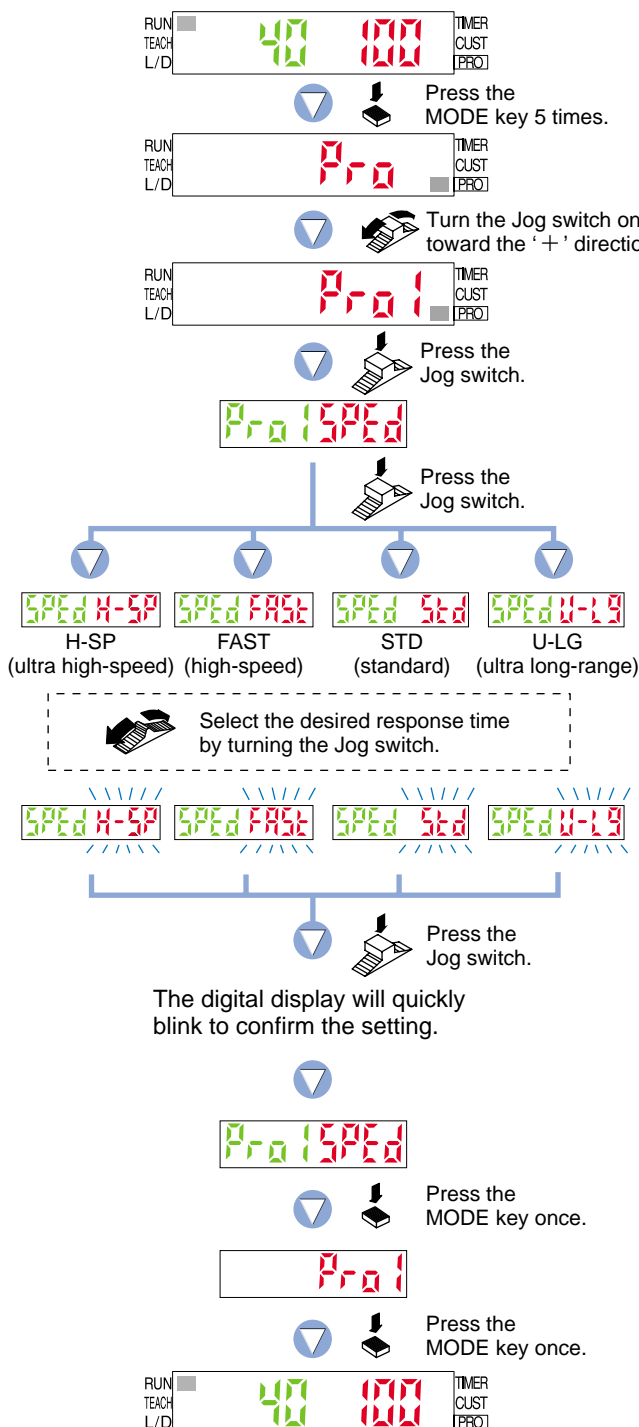

- ① Press the [MODE key] 5 times to select 'PRO mode'.
- ② Turn the [Jog switch] once toward the '+' direction, to select 'PRO1 mode'.
- ③ Press the [Jog switch] to enter the 'response time change' state.
- ④ If the [Jog switch] is pressed, the current response time (red) will be displayed.
* The factory setting is 'STD (standard)'.
- ⑤ If the [Jog switch] is turned, response time (red) will blink on the digital display.
Select the desired response time.
- ⑥ If the [Jog switch] is pressed, response time (red) will quickly blink on the digital display and the selected 'response time' will be confirmed.
[The digital display will not blink (red) if the setting has not been changed.]
* The receiving light sensitivity will be set to the maximum setting for the mode being set.
- ⑦ If the [MODE key] is pressed once, the amplifier will return to 'PRO1 mode'.
- ⑧ Press the [MODE key] once, the amplifier will return to 'RUN mode' (normal sensing operation).

5-3. Hysteresis Function

The hysteresis can be switched to one of three settings (small / standard / large) in all sensing modes except for hysteresis mode.

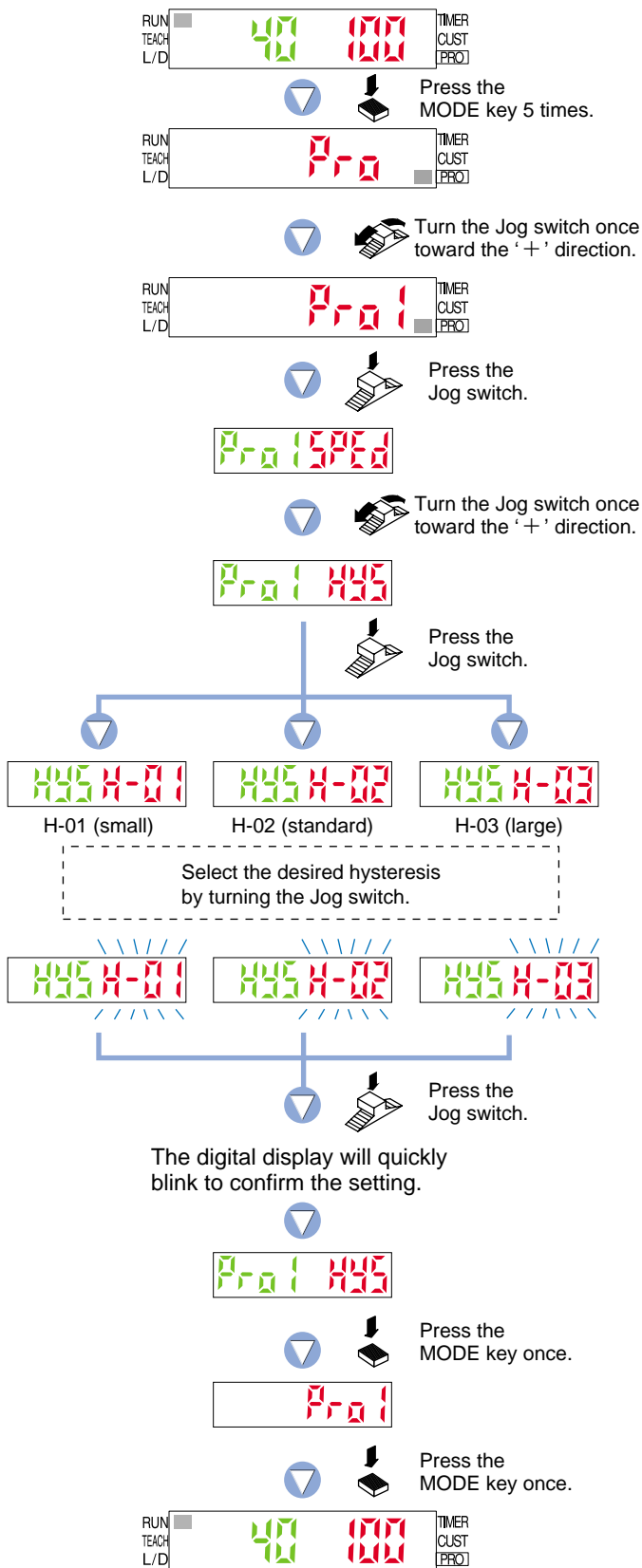

- ① Press the [MODE key] 5 times to select 'PRO mode'.
- ② Turn the [Jog switch] once toward the '+' direction, to select 'PRO1 mode'.
- ③ Press the [Jog switch] to enter the 'response time change' state.
- ④ Turn the [Jog switch] once toward the '+' direction, to enter the 'hysteresis setting' state.
- ⑤ If the [Jog switch] is pressed, the current 'hysteresis' level (red) will be displayed.
* The factory setting is 'H-02 (standard)'.
- ⑥ If the [Jog switch] is turned, hysteresis level (red) will blink on the digital display.
Select the desired 'hysteresis' level.
- ⑦ If the [Jog switch] is pressed, hysteresis level (red) will quickly blink on the digital display, confirming the 'hysteresis' level.
[The digital display will not blink (red) if the setting has not been changed.]
- ⑧ If the [MODE key] is pressed once, the amplifier will return to 'PRO1 mode'.
- ⑨ Press the [MODE key] once, the amplifier will return to 'RUN mode' (normal sensing operation).

5-4. Shift Function

Shifts the 'threshold value' by a certain percentage increment during 'limit teaching'.
 (The percentage adjustment is variable from approx. 5 % to 200 %, in increments of 1 %.)

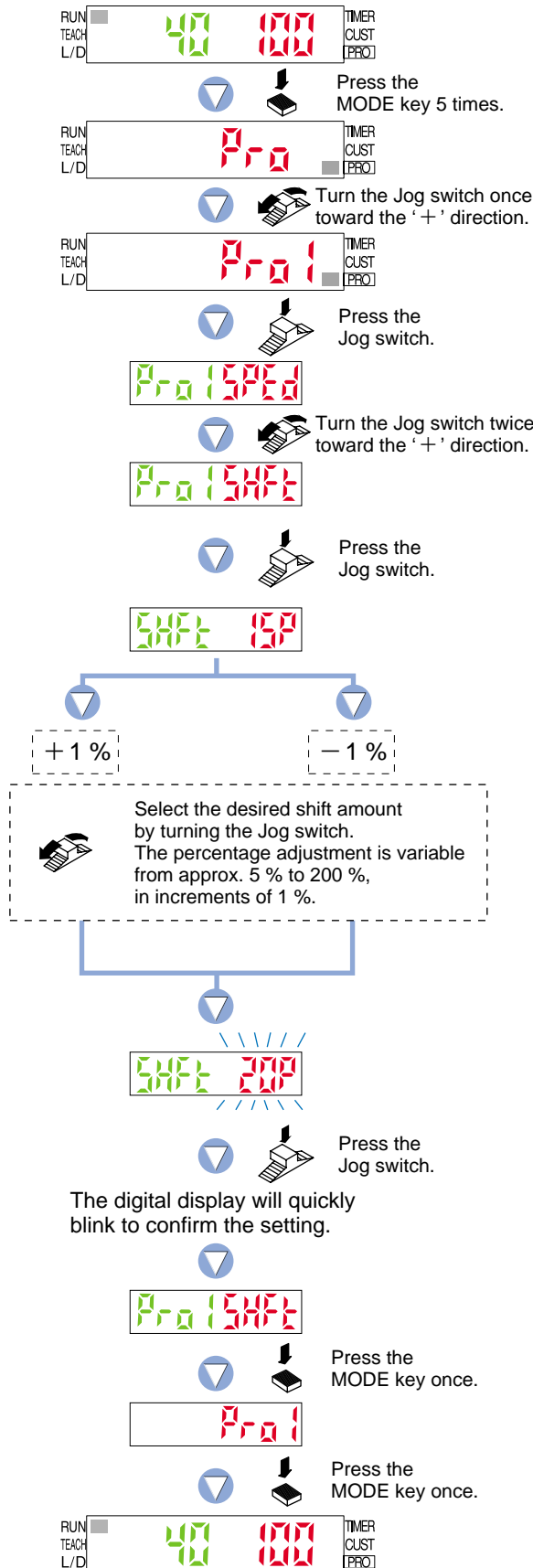

- ① Press the [MODE key] 5 times to select 'PRO mode'.
- ② Turn the [Jog switch] once toward the '+' direction, to select 'PRO1 mode'.
- ③ Press the [Jog switch] to enter the 'response time change' state.
- ④ Turn the [Jog switch] twice toward the '+' direction, to enter the 'shift setting' state.
- ⑤ If the [Jog switch] is pressed, the current 'shift amount' (red) will be displayed.
 * The factory setting is '15 %'.
- ⑥ If the [Jog switch] is turned, shift amount (red) will blink on the digital display.
 Select the desired 'shift amount'.
 (If the [Jog switch] is turned once toward the '+' direction, the shift amount will be + 1 %.
 If the [Jog switch] is turned once toward the '-' direction, the shift amount will be - 1 %.
 The available range for the shift amount:
 The percentage adjustment is variable from approx. 5 % to 200 %, in increments of 1 %.
- ⑦ If the [Jog switch] is pressed, shift amount (red) will quickly blink on the digital display, confirming the 'shift amount' setting.
 [The digital display will not blink (red) if the setting has not been changed.]
- ⑧ If the [MODE key] is pressed once, the amplifier will return to PRO1 mode'.
- ⑨ Press the [MODE key] once, the amplifier will return to 'RUN mode' (normal sensing operation).

5-5. M.G.S. Function

The receiving light sensitivity can be set to one of four levels (Level 4 (Note) / Level 3 / Level 2 / Level 1).

Note: Level 4 can only be set in ultra long-range (U-LG) mode.

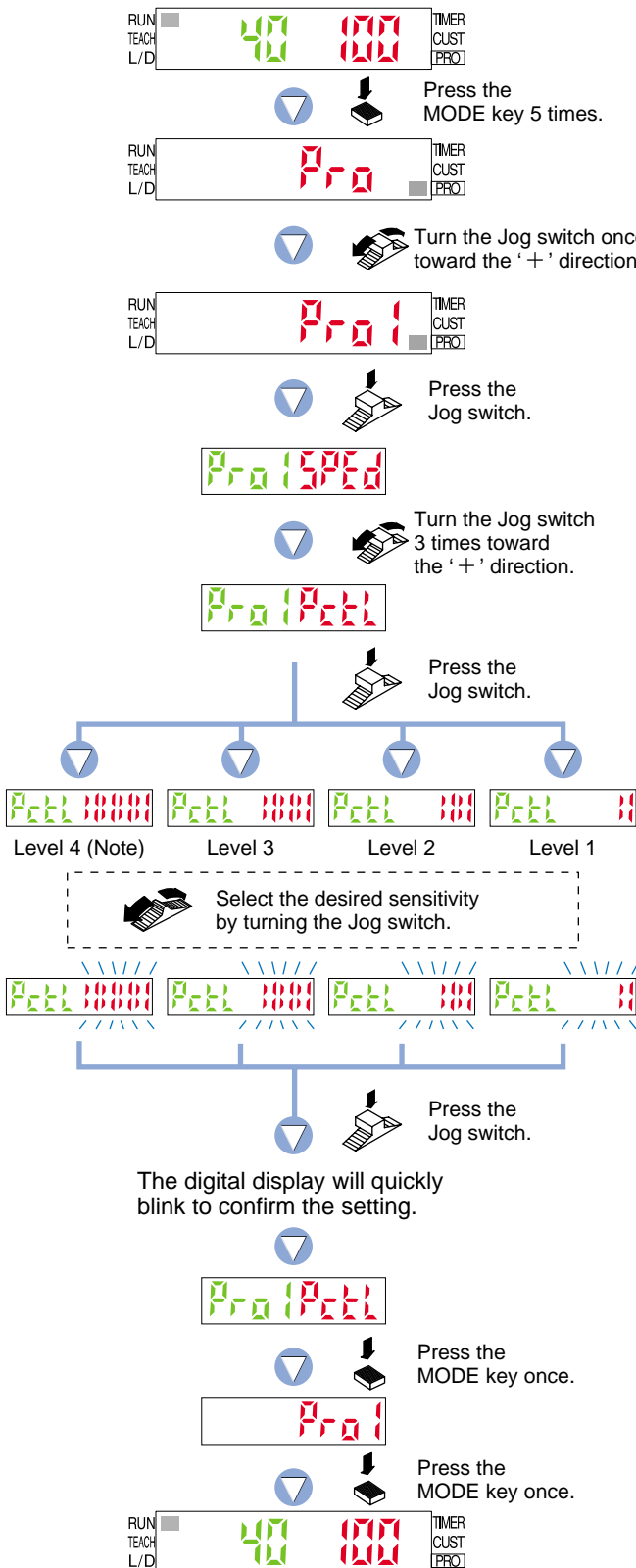

5-6. Emission Halt Function

This selects whether the laser is emitted or not.

* This only stops laser emission, and other operations (such as output operation and timer operation) continue functioning.

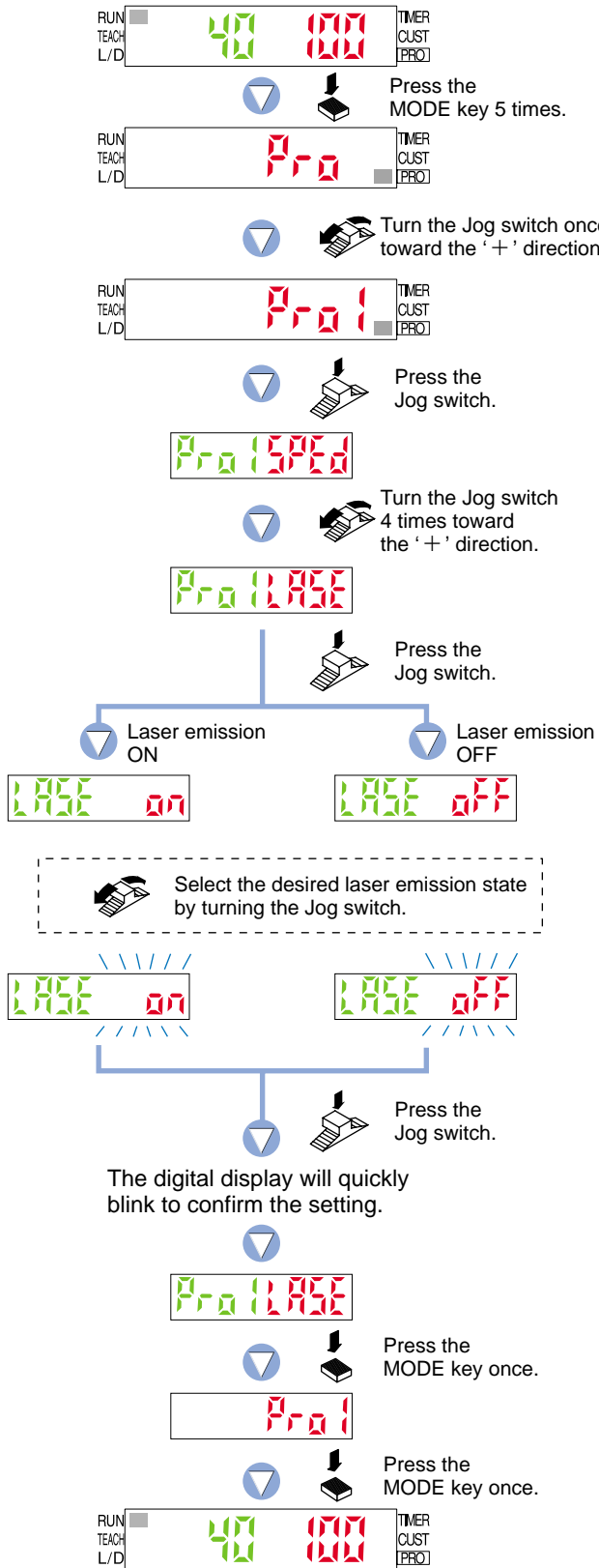

- ① Press the [MODE key] 5 times to select 'PRO mode'.
- ② Turn the [Jog switch] once toward the '+' direction, to select 'PRO1 mode'.
- ③ Press the [Jog switch] to enter the 'response time change' state.
- ④ Turn the [Jog switch] 4 times toward the '+' direction, to select 'emission halt setting'.
- ⑤ If the [Jog switch] is pressed, the current 'laser emission state' (red) will be displayed.
* When the power is turned on, laser emission is set to ON. (The setting is not stored.)
- ⑥ If the [Jog switch] is turned, laser emission state (red) will blink on the digital display. Select the desired 'laser emission state'.
- ⑦ If the [Jog switch] is pressed, laser emission state (red) will quickly blink on the digital display, and the selected 'laser emission state' will be confirmed.
[The digital display will not blink (red) if the setting has not been changed.]
- ⑧ If the [MODE key] is pressed once, the amplifier will return to 'PRO1 mode'.
- ⑨ Press the [MODE key] once, the amplifier will return to 'RUN mode' (normal sensing operation).

6 PRO2 Mode

6-1. PRO2 Mode Functions and Settings

PRO2 mode is used mainly for selecting the detailed configuration of the digital display and incident light intensity data processing.

* Output 1 and output 2 will both be changed to the same settings.

The settings can be carried out in either output 1 mode or output 2 mode.

: Display Switching Function

Refer to p. 32 for setting procedure

In RUN mode, the digital display is fixed to either incident light intensity, % or peak hold / bottom hold display, but you can select it to be a variable display. (Rising / trailing differential mode allows only incident light intensity display.)

* The factory setting is for 'no digital display switching'.

* Window comparator mode and hysteresis mode are the only modes that do not have digital display switching, so that display switching cannot be used in these modes. (1_SL and 2_SL can be switched.)

No digital display switching

When fixed at the incident light intensity display, the incident light intensity (changed intensity in rising / trailing differential mode) is displayed within the range of 0 to 9,999. (Note)



Note: The incident light intensity display can display a maximum value of 4,000 in H-SP (ultra high-speed) mode and FAST (high-speed) mode. In STD (standard) mode and U-LG (ultra long-range) mode, it can display up to a maximum value of 9,999.

Digital display switching

Normal mode

- Incident light intensity display

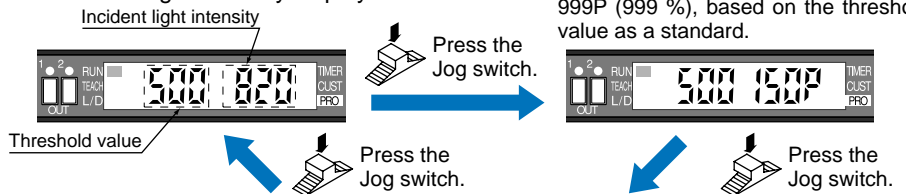

- Percentage display
This function displays the incident light intensity within a range of 0P (0 %) to 999P (999 %), based on the threshold value as a standard.

- Peak hold / Bottom hold display
This function displays the peak and bottom numerical value of the incident light intensity.



Blinking by turns.



Rising / Trailing differential mode

- Incident light intensity display

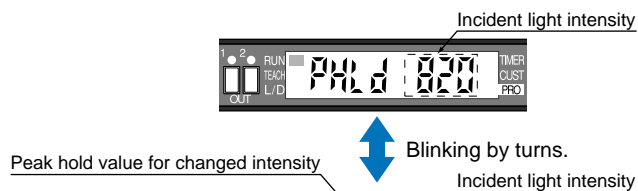
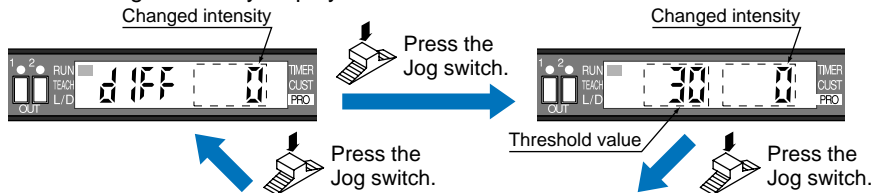

Display Timing for Peak Hold and Bottom Hold

Please note that the peak hold and bottom hold values will be resampled consecutively.

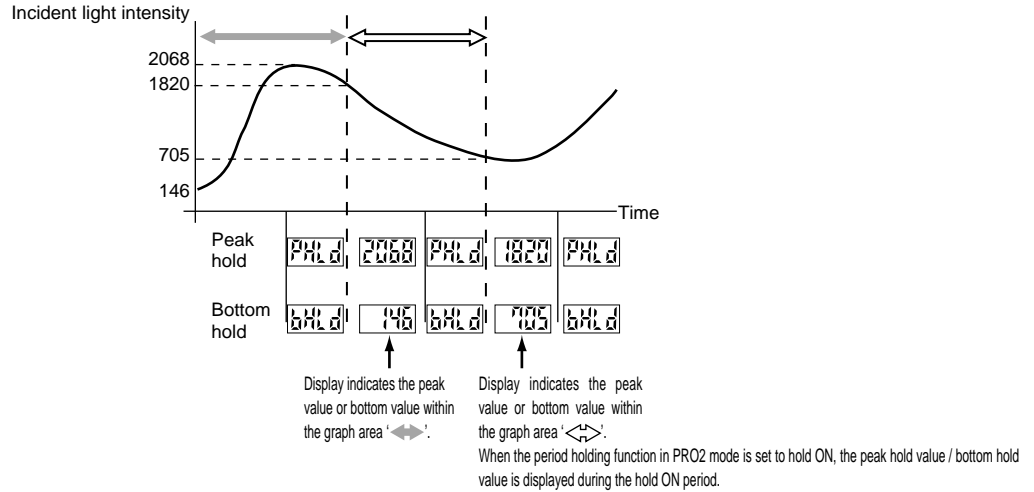

TURN : Display Turning Function

Refer to p. 33 for setting procedure

This function can be used to invert the display orientation, according to the direction of amplifier installation.

* The factory setting is 'Turn OFF'.

● When set to Turn OFF



● When set to Turn ON



ECO : ECO Mode Function

Refer to p. 34 for setting procedure

This function turns off the digital display to reduce current consumption.

If no operations are performed for 20 sec., the letters 'ECO' will blink and then the digital display will turn off.

If the [MODE key] or the [Jog switch] are operated, the digital display will light up again.

* The factory setting is 'ECO OFF'.

● When set to ECO OFF



● When set to ECO ON



Current Consumption

When ECO mode is OFF:

40 mA or less (at 24 V supply voltage)

When ECO mode is ON:

33 mA or less (at 24 V supply voltage)

HOLD : Period Holding Function

Refer to p. 35 for setting procedure

This selects whether the peak hold value / bottom hold value during the hold ON period or the peak hold value / bottom hold value within the digital display refresh period is displayed.

* The hold function starts operating from the value at the point when operation returns to RUN mode.

SAVE : Current Value Storage Function

Refer to p. 36 for setting procedure

The current incident light intensity value can be stored.

COMPARE : Stored Value Comparison Function

Refer to p. 37 for setting procedure

This displays the stored incident light intensity value and the present incident light intensity value at the same time so that you can check for things such as drops in incident light intensity.

6-2. Display Switching Function

In RUN mode, the digital display is fixed to either incident light intensity, % or peak hold / bottom hold display, but you can select it to be a variable display.

* The factory setting is for 'no digital display switching'.

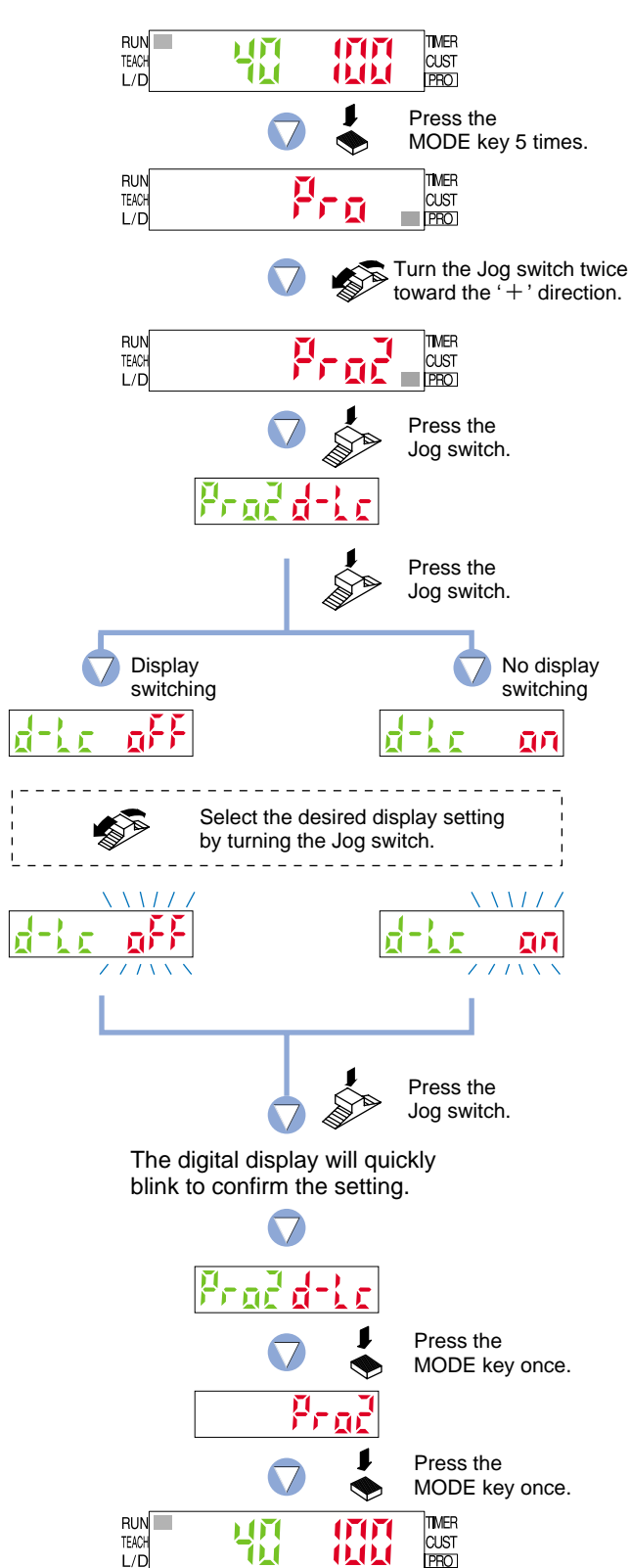

- ④ If the [Jog switch] is pressed, the current 'display switching
- ① Press the [MODE key] 5 times to select 'PRO mode'.
- ② Turn the [Jog switch] twice toward the '+' direction, to select 'PRO2 mode'.
- ③ Press the [Jog switch] to enter the 'display switching' state.
- ④ If the [Jog switch] is pressed, the current 'display switching setting' (red) will be displayed.
* The factory setting is 'No display switching'.
- ⑤ If the [Jog switch] is turned, display switching setting (red) will blink on the digital display.
Select the desired 'display switching setting'.
- ⑥ If the [Jog switch] is pressed, display switching setting (red) will quickly blink on the digital display, and the selected 'display switching setting' will be confirmed.
[The digital display will not blink (red) if the setting has not been changed.]
- ⑦ If the [MODE key] is pressed once, the amplifier will return to 'PRO2 mode'.
- ⑧ Press the [MODE key] once, the amplifier will return to 'RUN mode' (normal sensing operation).

6-3. Display Turning Function

This function can be used to invert the display orientation, according to the direction of amplifier installation.

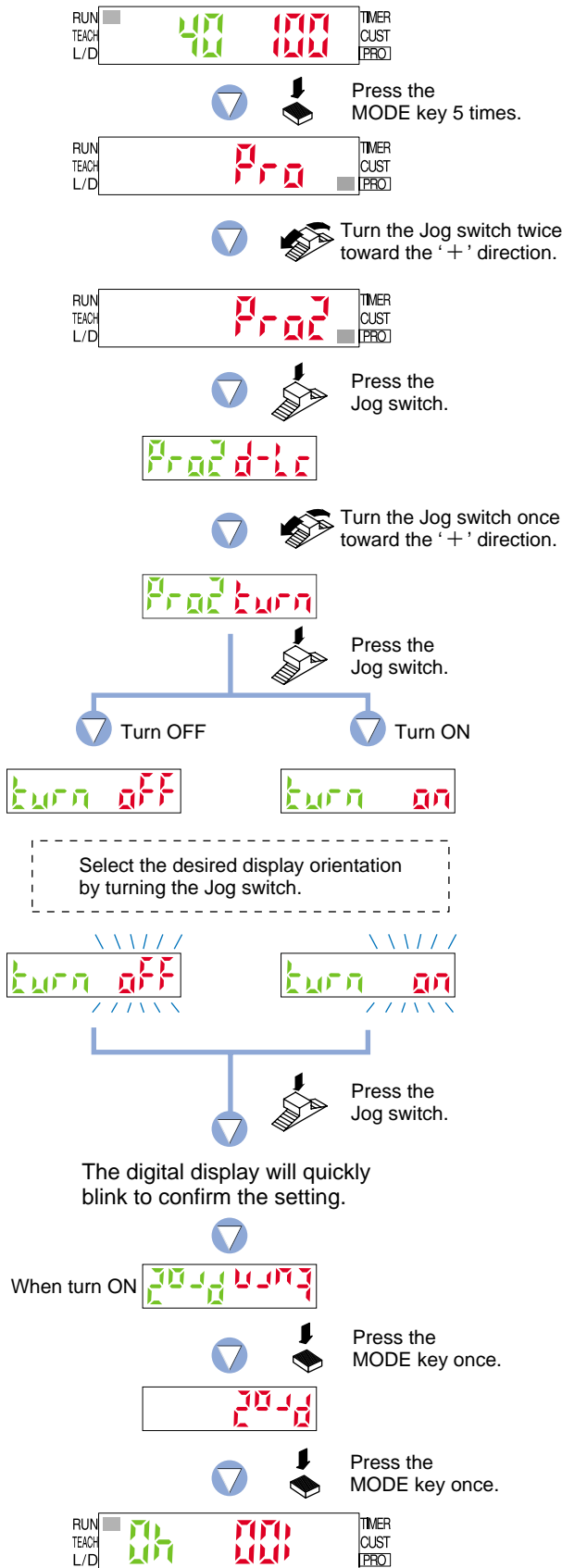

- ① Press the [MODE key] 5 times to select 'PRO mode'.
- ② Turn the [Jog switch] twice toward the '+' direction, to select 'PRO2 mode'.
- ③ Press the [Jog switch] to enter the 'display switching' state.
- ④ Turn the [Jog switch] once toward the '+' direction, to enter the 'display turning setting' state.
- ⑤ If the [Jog switch] is pressed, the current 'display orientation' (red) will be displayed.
* The factory setting is Turn OFF.
- ⑥ If the [Jog switch] is turned, display orientation (red) will blink on the digital display.
Select the desired 'display orientation'.
- ⑦ If the [Jog switch] is pressed, display orientation (red) will quickly blink on the digital display, and the selected 'display orientation' will be confirmed.
[The digital display will not blink (red) if the setting has not been changed.]
- ⑧ If the [MODE key] is pressed once, the amplifier will return to 'PRO2 mode'.
- ⑨ Press the [MODE key] once, the amplifier will return to 'RUN mode' (normal sensing operation).
To return the display to the original state, select the setting 'Turn OFF'.

6-4. ECO Mode Function

This function turns off the digital display to reduce power consumption.

If no operations are performed for 20 sec., the letters 'Eco' (green) will blink and then the digital display will turn off. If the [MODE key] or the [Jog switch] are operated, the digital display will light up again.

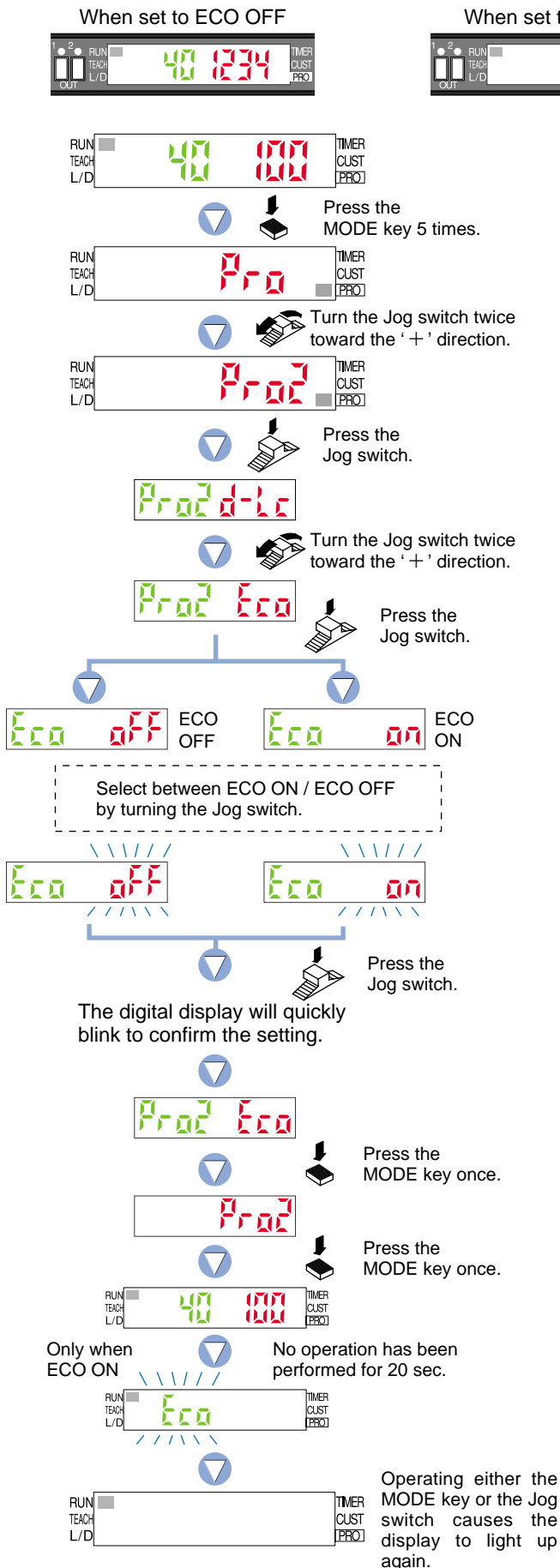

6-5. Period Holding Function

This selects whether the peak hold value / bottom hold value during the hold ON period or the peak hold value / bottom hold value within the digital display refresh period is displayed. When hold ON is set, holding starts from the point when the peak / bottom display appears in RUN mode.

* Before using this function, set the display switching function to 'Display switching'. (Refer to p. 32.)

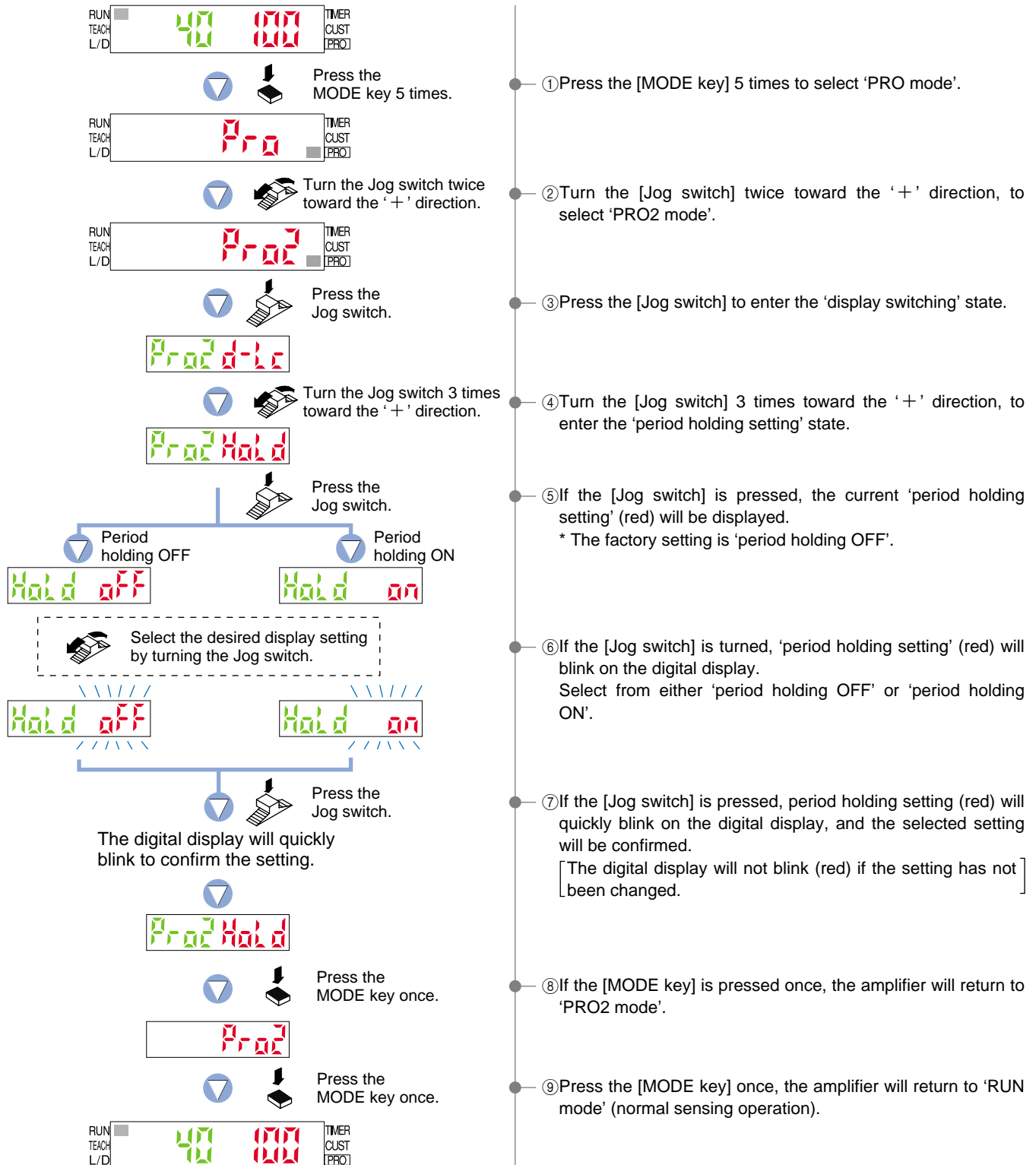

6-6. Current Value Storage Function

The current incident light intensity value can be stored.

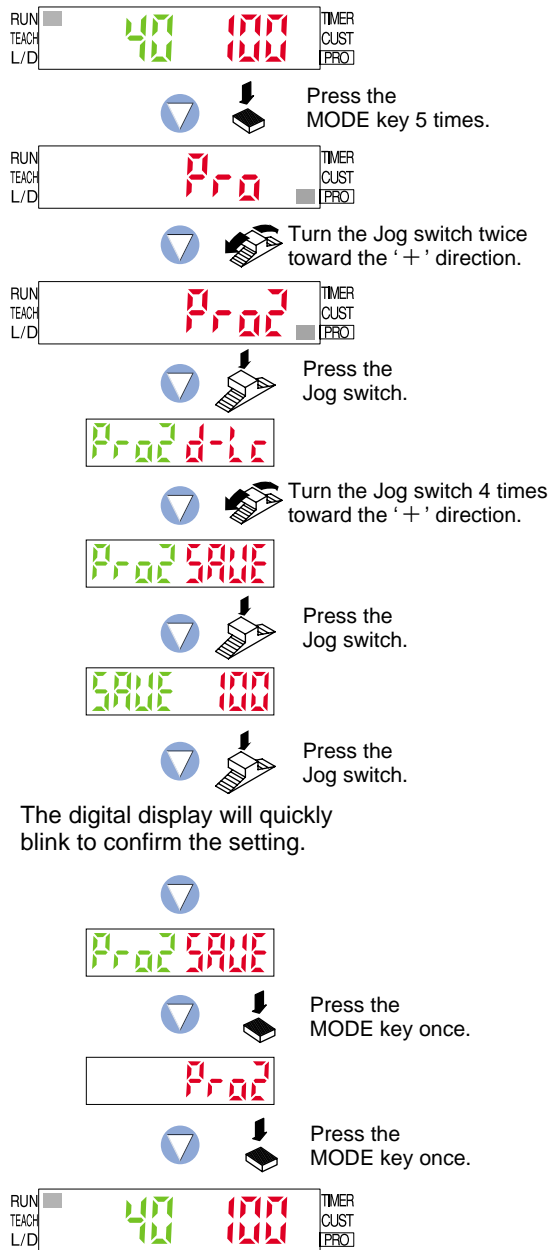

- ① Press the [MODE key] 5 times to select 'PRO mode'.
- ② Turn the [Jog switch] twice toward the '+' direction, to select 'PRO2 mode'.
- ③ Press the [Jog switch] to enter the 'display switching' state.
- ④ Turn the [Jog switch] 4 times toward the '+' direction, to enter the 'current value storage setting' state.
- ⑤ If the [Jog switch] is pressed, the current 'incident light intensity' (red) will be displayed.
- ⑥ If the [Jog switch] is pressed, incident light intensity (red) will quickly blink on the digital display, and the data will be stored.
- ⑦ If the [MODE key] is pressed once, the amplifier will return to 'PRO2 mode'.
- ⑧ Press the [MODE key] once, the amplifier will return to 'RUN mode' (normal sensing operation).

6-7. Stored Value Comparison Function

This displays the stored incident light intensity value and the present incident light intensity value at the same time so that you can check for things such as drops in incident light intensity.

* Before using the stored value comparison function, you need to store the present incident light intensity.

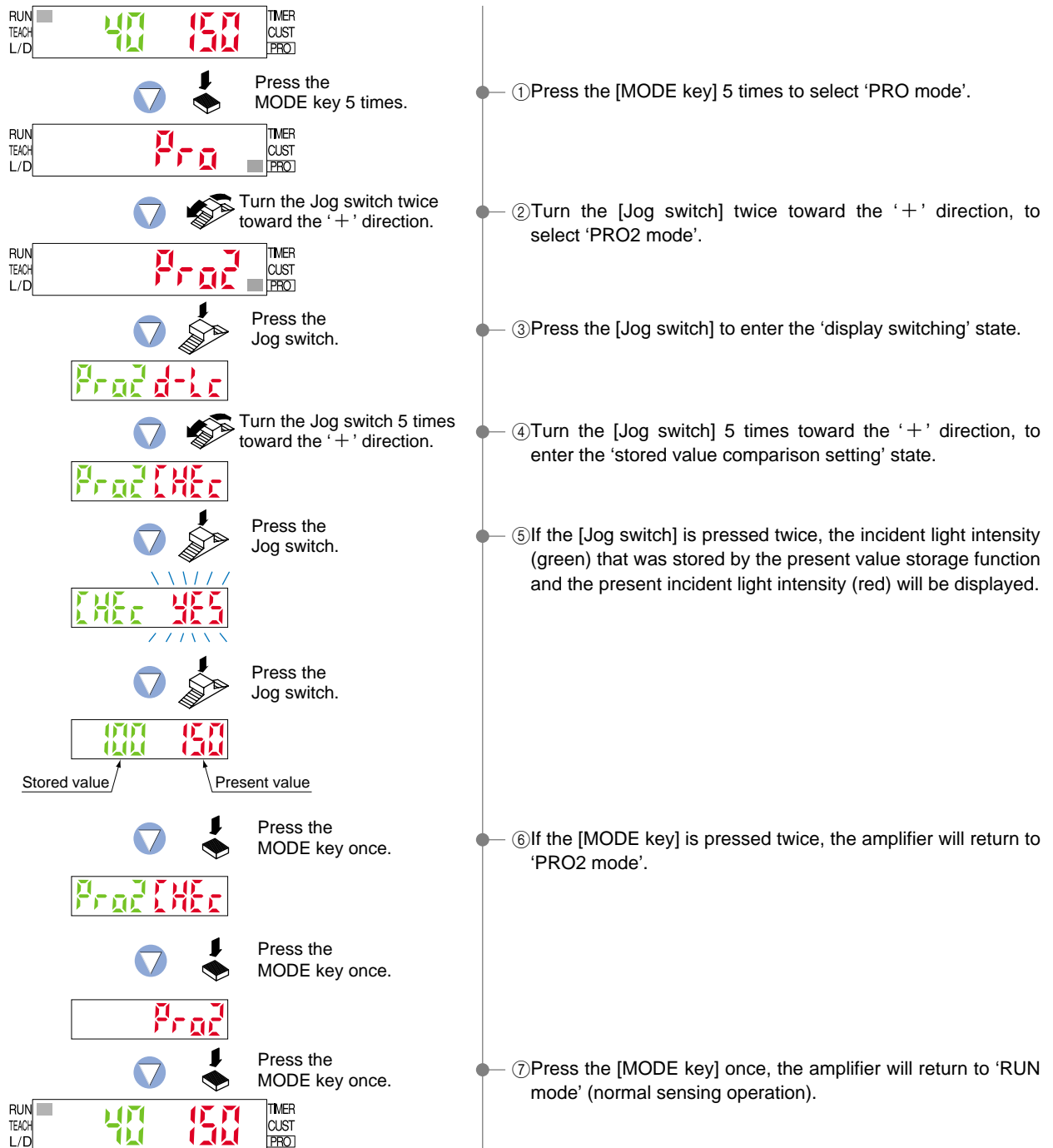

7 PRO3 Mode

7-1. PRO3 Mode Functions and Settings

PRO3 mode can load settings from the data bank and can save settings to the data bank.

Data bank

The **LS-400** series incorporates an internal memory for storing setting.

Three different sets of settings can be stored within the data banks, in channels 1 (1CH) to 3 (3CH).

These settings will not be deleted, unless they are intentionally overwritten by the data bank save setting function.

(Setting within the data bank will not be deleted, even when a reset is performed using the '9-4. Setting Reset' Function' from 'PRO5 Mode' on p. 50.)

4CH : Data Bank Load Function

Refer to p. 39 for setting procedure

This function allows settings from the data bank to be selected and then loaded.

This feature allows settings to be changed quickly at times of reconfiguration, etc.

You can select whether the settings for only one amplifier are loaded or the settings for all amplifiers on the right side that are connected via optical communication are loaded all in a single step.

4CH : Data Bank Save Function

Refer to p. 40 for setting procedure

This function saves amplifier settings.

Up to 3 sets of settings can be saved in '1CH', '2CH' and '3CH'.

You can select whether the settings for only one amplifier are saved or the settings for all amplifiers on the right side that are connected via optical communication are saved all in a single step.

Optical communication

When the collective data bank load / save function or copy function is used via optical communication, loading / saving or copy of the setting can be carried out only to the amplifiers (sub units) connected on the right side of the amplifier (main unit). However, if the amplifier (sub unit) is being connected (the indicator blinks), PRO mode is being set or the transmission change to permit / not to permit function is set to 'not to permit', loading / saving or copy is not carried out. Furthermore, the sensing operation stops during optical communication.

Example: When 16 amplifiers are connected in the side-by-side configuration

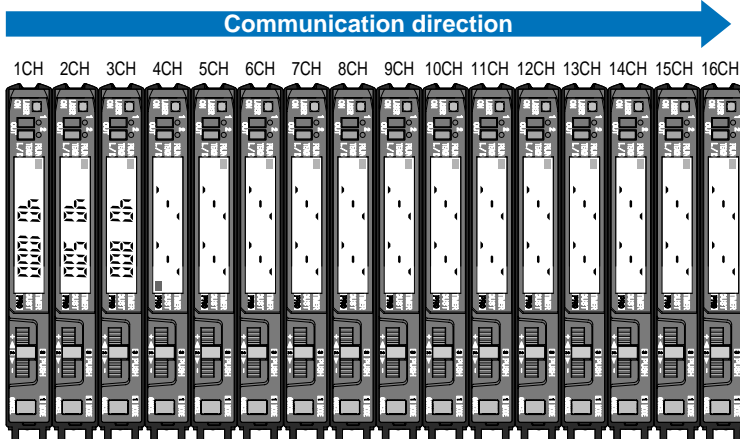

To copy the same settings to the 4th and subsequent channels:
Use the 4-channel data bank load / save function and the copy function.

To copy the same settings to the 1st and subsequent channels:
Use the 1-channel single step data bank load / save function and the copy function.

* The incident light intensity display changes while optical communication is in progress.

7-2. Data Bank Load Function

This function allows settings from the data bank to be selected and then loaded.

This feature allows settings to be changed quickly at times of reconfiguration, etc.

You can select whether the settings for only one amplifier are loaded or the settings for all amplifiers on the right side that are connected via optical communication are loaded all in a single step.

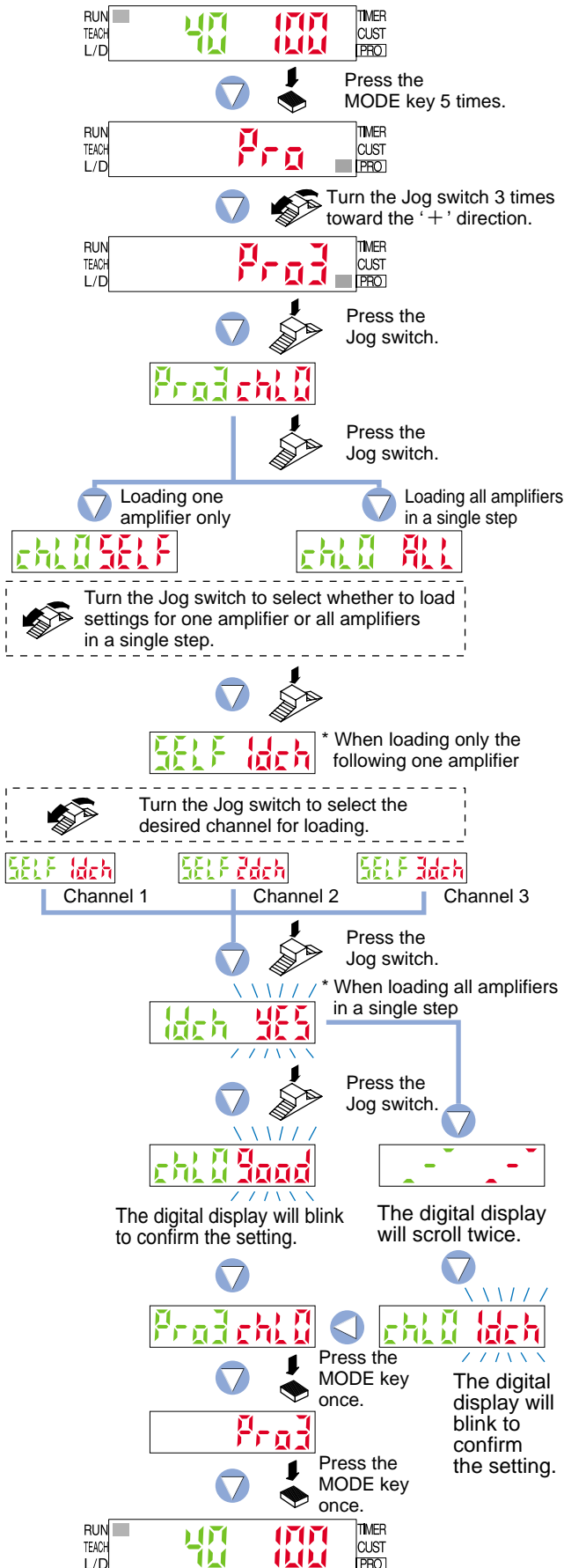

7-3. Data Bank Save Function

This function saves amplifier settings.

Up to 3 sets of settings can be saved using '1dch', '2dch' and '3dch'.

You can select whether the settings for only one amplifier are saved or the settings for all amplifiers on the right side that are connected via optical communication are saved all in a single step.

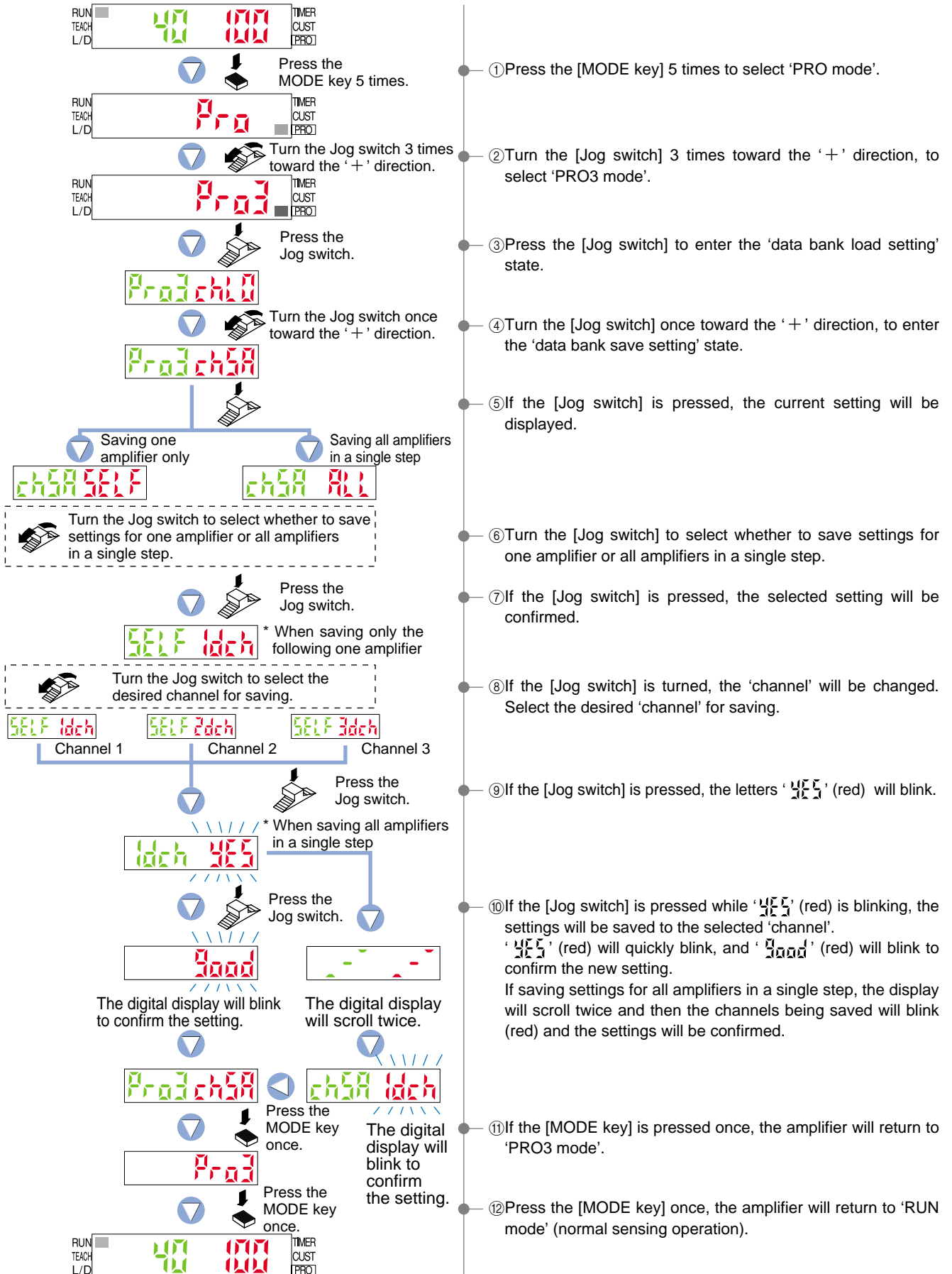

8 PRO4 Mode

8-1. PRO4 Mode Functions and Settings

PRO4 mode is mainly used for configuring communication with sub units and external input modes.

Copy Function

Refer to p. 42 for setting procedure

By utilizing the optical communications function, the settings information from the operating amplifier can be copied to other connected amplifiers. (Except for data bank contents) However, the 0-Adjust setting function and transmission change to permit / not to permit function will not be copied. As well, in amplifiers in which the optical communications settings change function has been locked, copying will not occur.

Selection for transmission change to permit / not to permit

Refer to p. 43 for setting procedure

When attempting to perform single step load / save / copy operations using the data bank load function and data bank save function from PRO3 mode, and copy function from PRO4 mode, if the transmission change has not been permitted, then only the specified amplifier will be locked. Therefore single step load / save / copy operations will be disabled.

* The factory setting is 'Lock OFF'.

External Input Switch Setting Function

Refer to p. 44 for setting procedure
Equipped with cable type only.

Selects 'emission halt', 'full-auto teaching' or 'limit teaching' using external input wires.

Time chart

In case of selecting emission halt ()

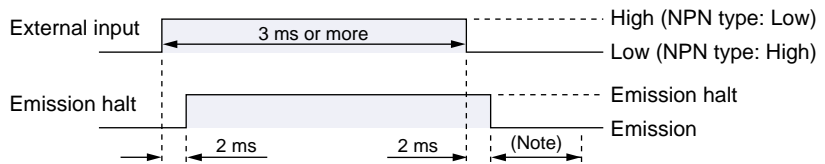

Note: Output operations are undefined only for the response time.

When the output signal is being received by a PLC or other device, set the timer to 2 ms + sensor response time or longer.

Example: For the response time in STD mode (500 μ s)

Timer period: 2 ms + 0.5 ms (500 μ s) = 2.5 ms

Signal conditions: High... +5 V to +V, or open (NPN type), +4 V to +V (PNP type)

Low...0 to +2 V (NPN type), 0 to +0.6 V, or open (PNP type)

In case of selecting limit teaching ()

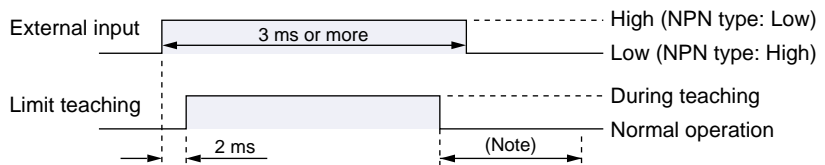

Note: After teaching is finished, output operations are undefined only for the response time.

When the output signal is being received by a PLC or other device, set the timer to the sensor response time or longer.

The incident light intensity at the instant teaching is recognized is set as the standard threshold value.

In case of selecting full-auto teaching ()

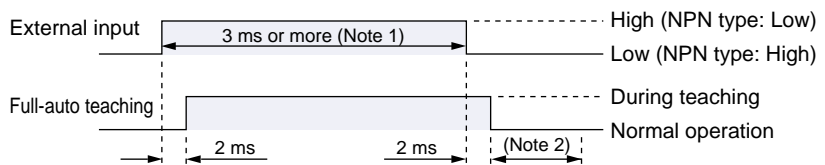

Notes: 1) Pass the sensing object past the sensor once while an input signal is being input.

2) After teaching is finished, output operations are undefined only for the response time.

When the output signal is being received by a PLC or other device, set the timer to the sensor response time or longer.

Backup Function

Refer to p. 45 for setting procedure
Equipped with cable type only.

This function is used for not storing the threshold value obtained from external input teaching into the EEPROM.

It prevents unnecessary writing to the EEPROM.

* Note that when the power is turned off, the threshold value becomes the value that was last stored in memory.

8-2. Copy Function

By utilizing the optical communications function, the settings information from the operating amplifier can be copied to other connected amplifiers. (Except for data bank contents) However, the 0-Adjust function and transmission change to permit / not to permit function will not be copied. However, in amplifiers in which the transmission change has not been permitted, copying will not occur.

Please refer to p. 38 [Optical communications](#) for the direction of optical communication.

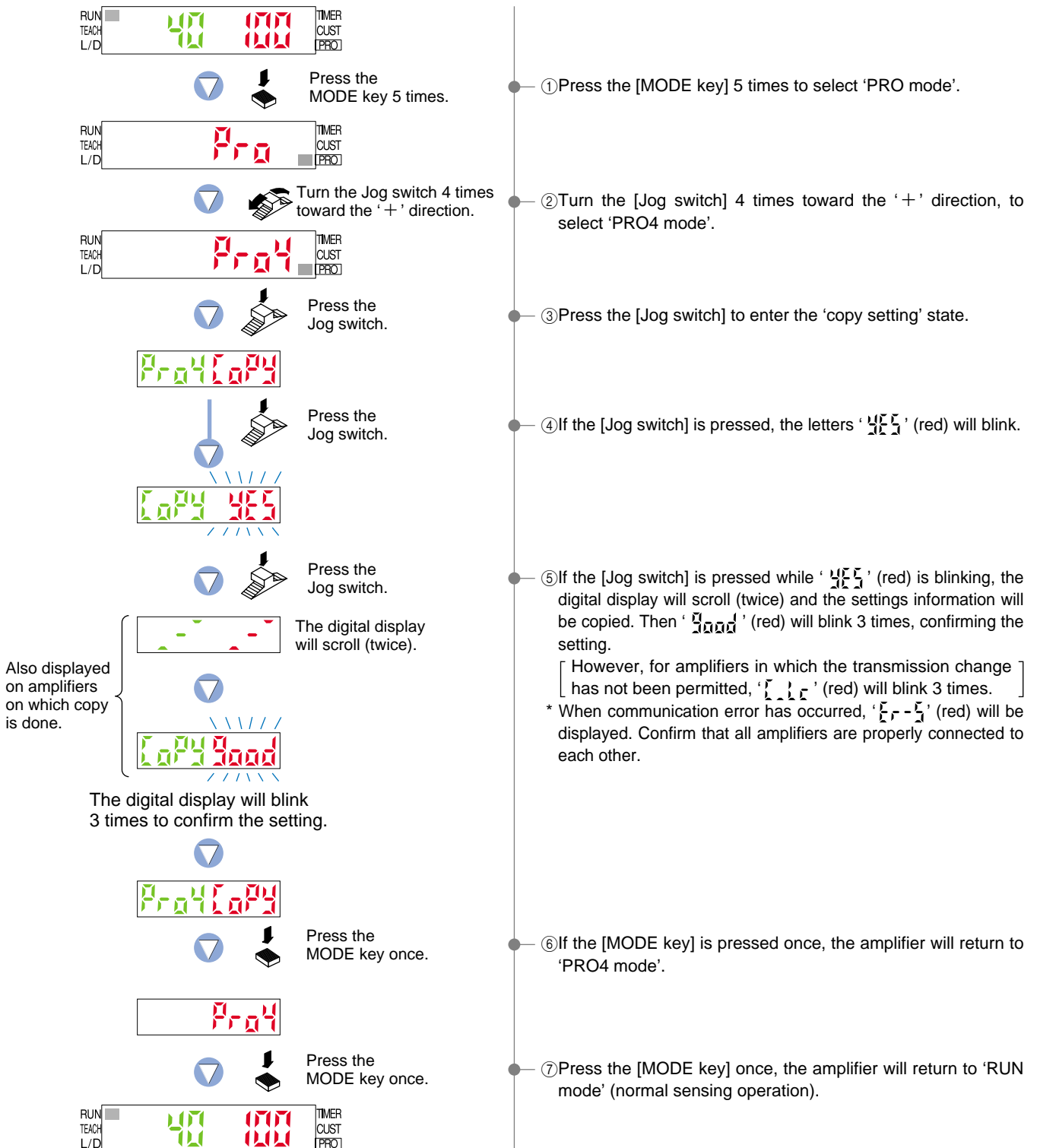

8-3. Selection for Transmission Change to Permit / Not to Permit

When attempting to perform single step load / save / copy operations using the setting condition data bank load function and data bank save function from PRO3 mode, and copy function from PRO4 mode, if the transmission change has not been permitted, then only the specified amplifier will be locked. Therefore single step load / save / copy operations will be disabled.

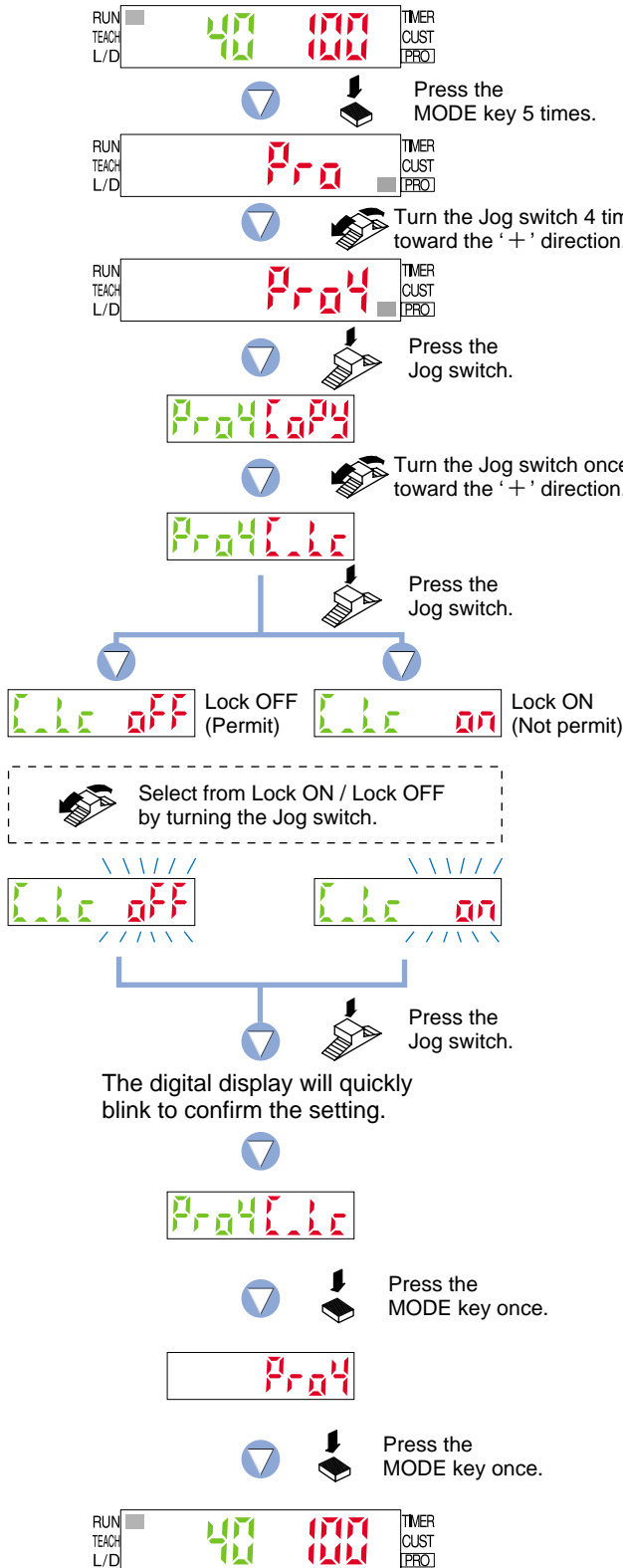

- ① Press the [MODE key] 5 times to select 'PRO mode'.
- ② Turn the [Jog switch] 4 times toward the '+' direction, to select 'PRO4 mode'.
- ③ Press the [Jog switch] to enter the 'copy setting' state.
- ④ Turn the [Jog switch] once toward the '+' direction, to enter the 'selection for transmission change to permit / not to permit' state.
- ⑤ If the [Jog switch] is pressed, the current setting (red) will be displayed.
* The factory setting is 'Lock OFF (permit)'.
- ⑥ If the [Jog switch] is turned, the setting (red) will blink. Select from either 'Lock ON' or 'Lock OFF'.
- ⑦ If the [Jog switch] is pressed, the setting (red) will quickly blink on the digital display, and 'Lock ON / OFF' will be confirmed.
[The digital display will not blink (red) if the setting has not been changed.]
- ⑧ If the [MODE key] is pressed once, the amplifier will return to 'PRO4 mode'.
- ⑨ Press the [MODE key] once, the amplifier will return to 'RUN mode' (normal sensing operation).

8-4. External Input Switch Setting Function

Selects 'emission halt', 'full-auto teaching' or 'limit teaching' using external input wires.

* Equipped with cable type only.

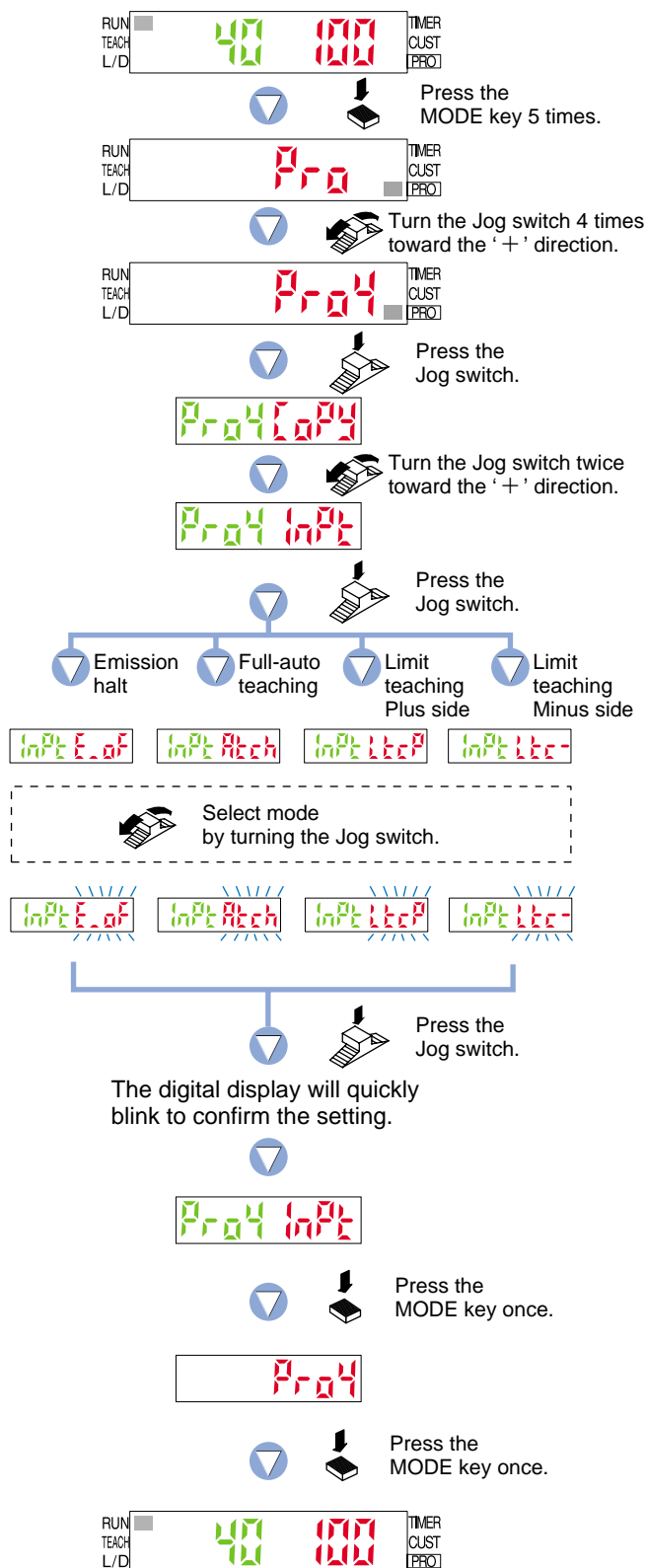

- ① Press the [MODE key] 5 times to select 'PRO mode'.
- ② Turn the [Jog switch] 4 times toward the '+' direction, to select 'PRO4 mode'.
- ③ Press the [Jog switch] to enter the 'copy setting' state.
- ④ Turn the [Jog switch] twice toward the '+' direction, to enter the 'external input switch setting' state.
- ⑤ If the [Jog switch] is pressed, the current setting (red) will be displayed.
* The factory setting is 'emission halt'.
- ⑥ If the [Jog switch] is turned, external input mode (red) will blink on the digital display.
Select mode.
- ⑦ If the [Jog switch] is pressed, external input mode (red) will quickly blink on the digital display, confirming the mode.
[The digital display will not blink (red) if the setting has not been changed.]
- ⑧ If the [MODE key] is pressed once, the amplifier will return to 'PRO4 mode'.
- ⑨ Press the [MODE key] once, the amplifier will return to 'RUN mode' (normal sensing operation).

8-5. Backup Function

This function is used for not storing the threshold value obtained from external input teaching into the EEPROM. It prevents unnecessary writing to the EEPROM.

* Equipped with cable type only.

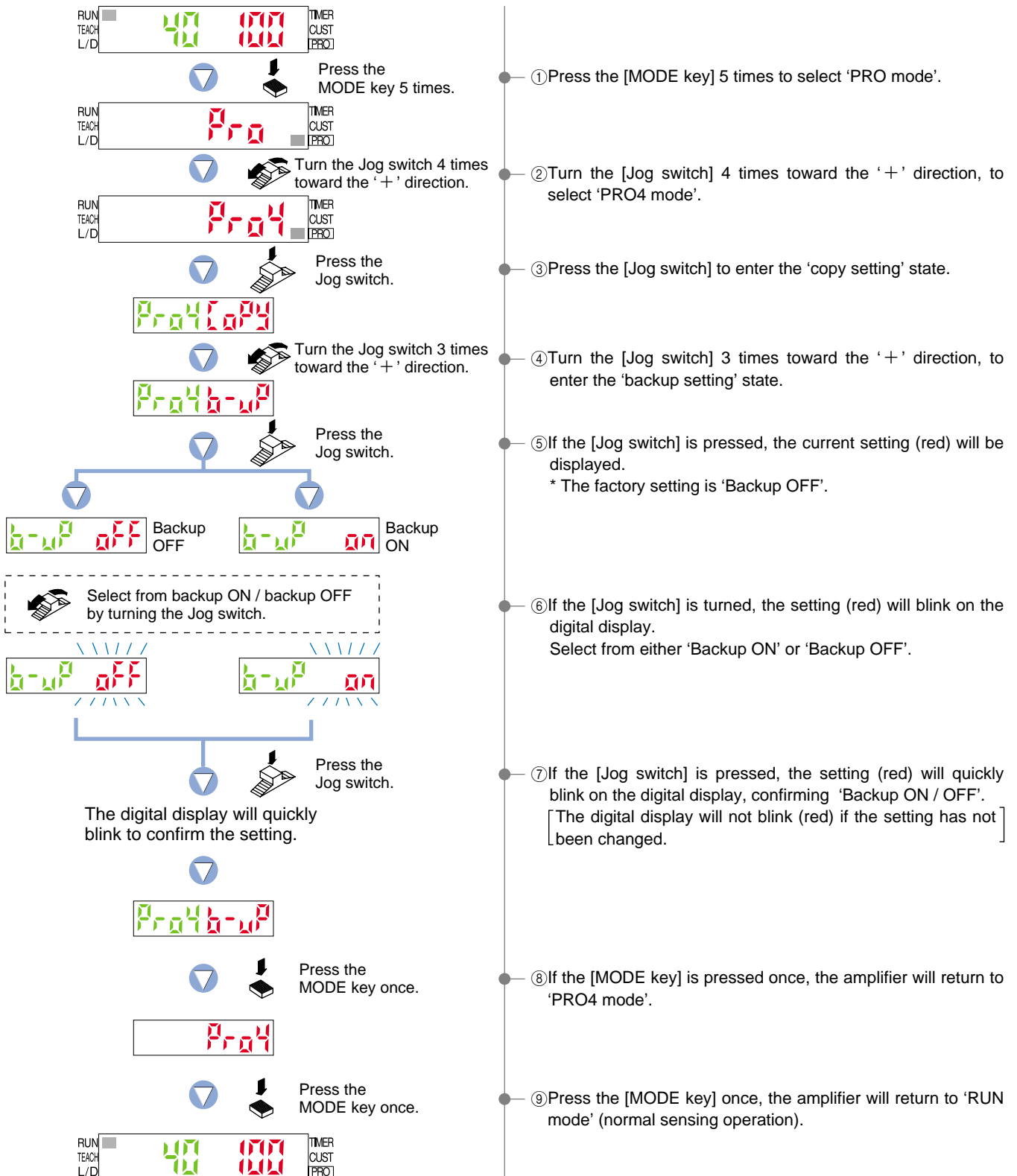

9 PRO5 Mode

9-1. PRO5 Mode Functions and Settings

PRO5 mode allows code setting, 0-adjust, setting reset (re-initialized), and setting of CUSTOM mode display.

Code Setting

The **LS-400** series contain certain encoded basic information that can be set by inputting a 8-digit code. The functions that may be set using direct coding are: Response time, Hysteresis, Output operation, M.G.S., External input mode, Timer operation and CUSTOM mode display.

* Output 1 and output 2 settings are possible for output operation only.

[Code Setting Table]

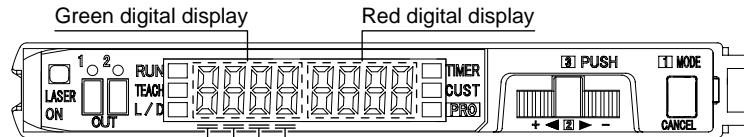

● Green digital display

First digit		Second digit		Third digit		Fourth digit	
Direct code	Output operation (Output 1-Output 2)	Direct code	Timer operation	Direct code	Response time	Direct code	M.G.S.
0	L-ON·L-ON	0	NON	0	STD	0	Level 3
1	L-ON·D-ON	1	ON-delay	1	H-SP	1	Level 2
2	D-ON·L-ON	2	OFF-delay	2	FAST	2	Level 1
3	D-ON·D-ON	3	ONE-SHOT	3	U-LG	3	Level 4
4	—	4	—	4	—	4	—
5	—	5	—	5	—	5	—
6	—	6	—	6	—	6	—
7	—	7	—	7	—	7	—
8	—	8	—	8	—	8	—
9	—	9	—	9	—	9	—

0: The highlighted line indicates the default code (factory setting).

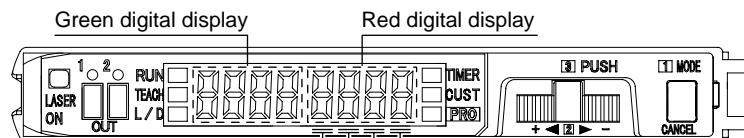

● Red digital display

First digit		Second digit		Third digit		Fourth digit			
Direct code	Hysteresis	Transmission change lock	Direct code	External input mode	Backup	Direct code	CUSTOM	Direct code	Sensing mode
0	H-02	OFF	0	Emission halt	ON	0	Response time	0	Normal 2 output
1	H-02	ON	1	Emission halt	OFF	1	M.G.S.	1	Window comparator
2	H-03	OFF	2	Full-auto	ON	2	Emission halt	2	Rising differential
3	H-03	ON	3	Full-auto	OFF	3	Data bank load	3	Trailing differential
4	H-01	OFF	4	Limit +	ON	4	Code setting	4	Hysteresis
5	H-01	ON	5	Limit +	OFF	5	—	5	Output 2 OFF
6	—	—	6	Limit -	ON	6	—	6	—
7	—	—	7	Limit -	OFF	7	—	7	—
8	—	—	8	—	—	8	—	8	—
9	—	—	9	—	—	9	—	9	—

0: The highlighted line indicates the default code (factory setting).

Note: Connector type **LS-401(P)** shows only '0'.

Note

- If function settings (Response time, Hysteresis, Output operation, M.G.S., External input mode, Timer operation, CUSTOM mode display, etc.) are changed, the changes will be reflected in the configuration and the numerical value of the code will be automatically updated.

Code : Code Setting Function

Refer to p. 48 for setting procedure

The input of a 8-digit code allows the configuration to be set directly, without the need to set each individual function.

0Adj : 0-Adjust Setting Function

Refer to p. 49 for setting procedure

This function allows for automatic zeroing of the incident light intensity.

SEt : Setting Reset Function

Refer to p. 50 for setting procedure

This function will cause all configuration settings to revert to factory settings. However, any settings that have been saved within the data bank will not be changed.

Please refer to the '3-2. Factory Settings' on p. 4.

CuSt : CUSTOM Mode Display Function

Refer to p. 51 for setting procedure

This selects one function that you would like to display in the navigation display in CUSTOM mode.

9-2. Code Setting Function

The input of a 8-digit code allows the configuration to be set directly, without the need to set each individual function.

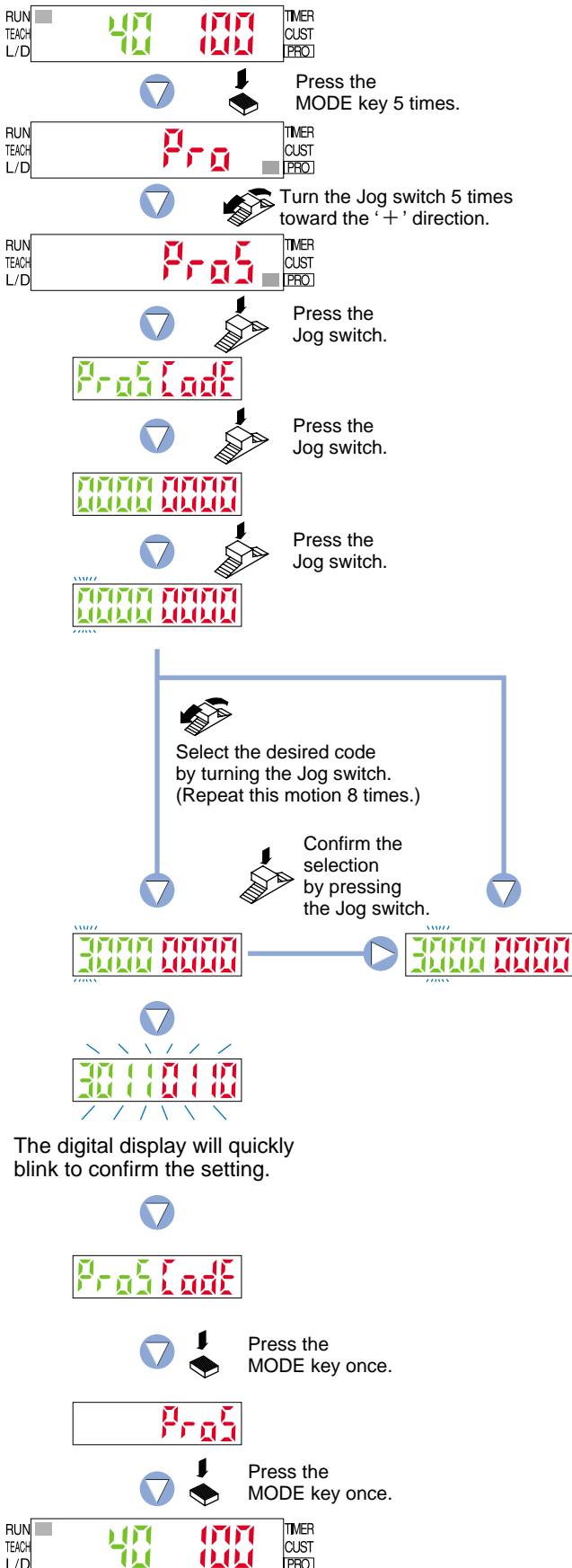

- ① Press the [MODE key] 5 times to select 'PRO mode'.
- ② Turn the [Jog switch] 5 times toward the '+' direction, to select 'PRO5 mode'.
- ③ Press the [Jog switch] to enter the 'code setting' state.
- ④ If the [Jog switch] is pressed, the current setting will be displayed.
* The factory setting is '0000 0000'.
- ⑤ If the [Jog switch] is pressed, the first green digit will blink.
- ⑥ Repeat the following motions: select the code by turning the [Jog switch], then confirm each selection by pressing the [Jog switch].
Once 8-digit have been input, the digital display (green and red) will quickly blink, confirming the 'code' setting.
[The digital display will not blink (green and red) if the setting has not been changed.]
Refer to the 'Code Setting Table' on p. 46 for code setting.
- ⑦ If the [MODE key] is pressed once, the amplifier will return to 'PRO5 mode'.
- ⑧ Press the [MODE key] once, the amplifier will return to 'RUN mode' (normal sensing operation).

9-3. 0-Adjust Setting Function

This function allows for automatic zeroing of the incident light intensity.

* The threshold value is not linked to this function, so that after carrying out zero adjustment, be sure to reset the threshold value.

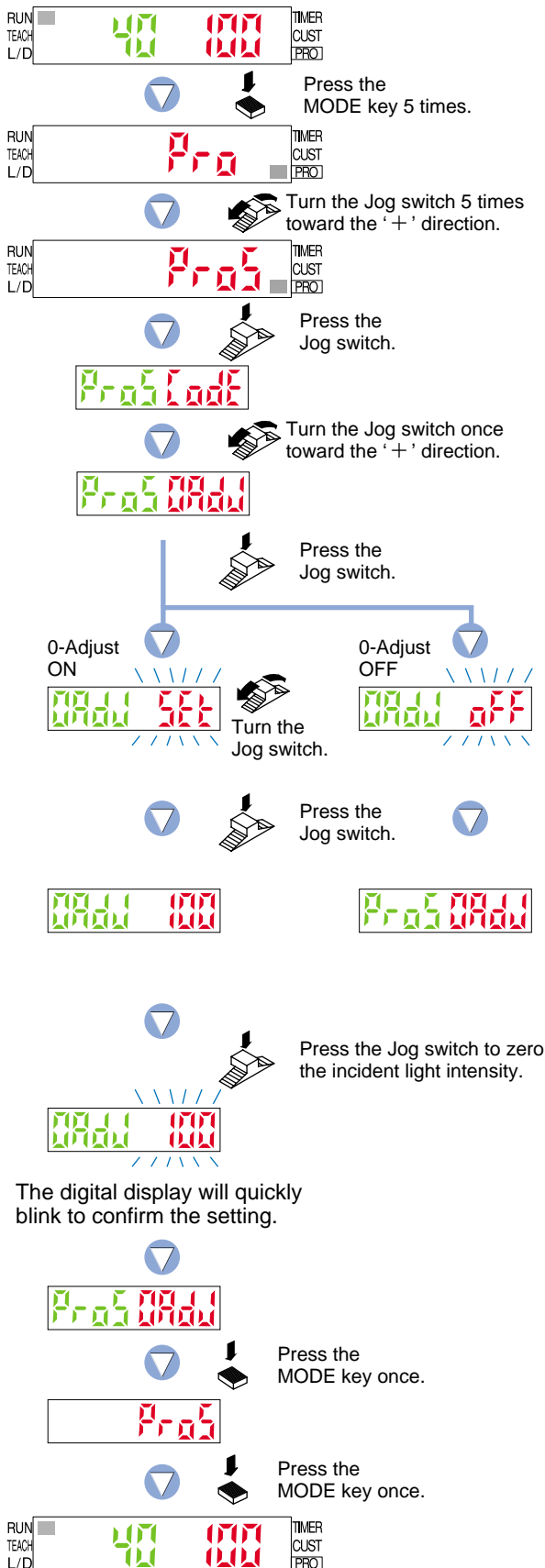

9-4. Setting Reset Function

This function will cause all settings to revert to factory settings. However, any settings that have been saved within the data bank will not be changed.

If the information stored within the data bank is to be changed, then data bank settings must be overwritten with new settings by using the '7-3. Data Bank Save Function' from 'PRO3 Mode', described on p. 40.



Press the MODE key 5 times.



Turn the Jog switch 5 times toward the '+' direction.



Press the Jog switch.



Turn the Jog switch twice toward the '+' direction.



Press the Jog switch.



Press the Jog switch.



- ① Press the [MODE key] 5 times to select 'PRO mode'.
- ② Turn the [Jog switch] 5 times toward the '+' direction, to select 'PRO5 mode'.
- ③ Press the [Jog switch] to enter the 'code setting' state.
- ④ Turn the [Jog switch] twice toward the '+' direction, to enter the 'reset setting' state.
- ⑤ If the [Jog switch] is pressed, the letters '565' (red) will be displayed.
- ⑤ If the [Jog switch] is pressed, the letters '565' (red) will quickly blink to reset all setting to factory setting. After that, the amplifier will automatically return to 'RUN mode' (normal sensing operation).

9-5. CUSTOM Mode Display Function

This selects one function that you would like to display in the navigation display in CUSTOM mode.

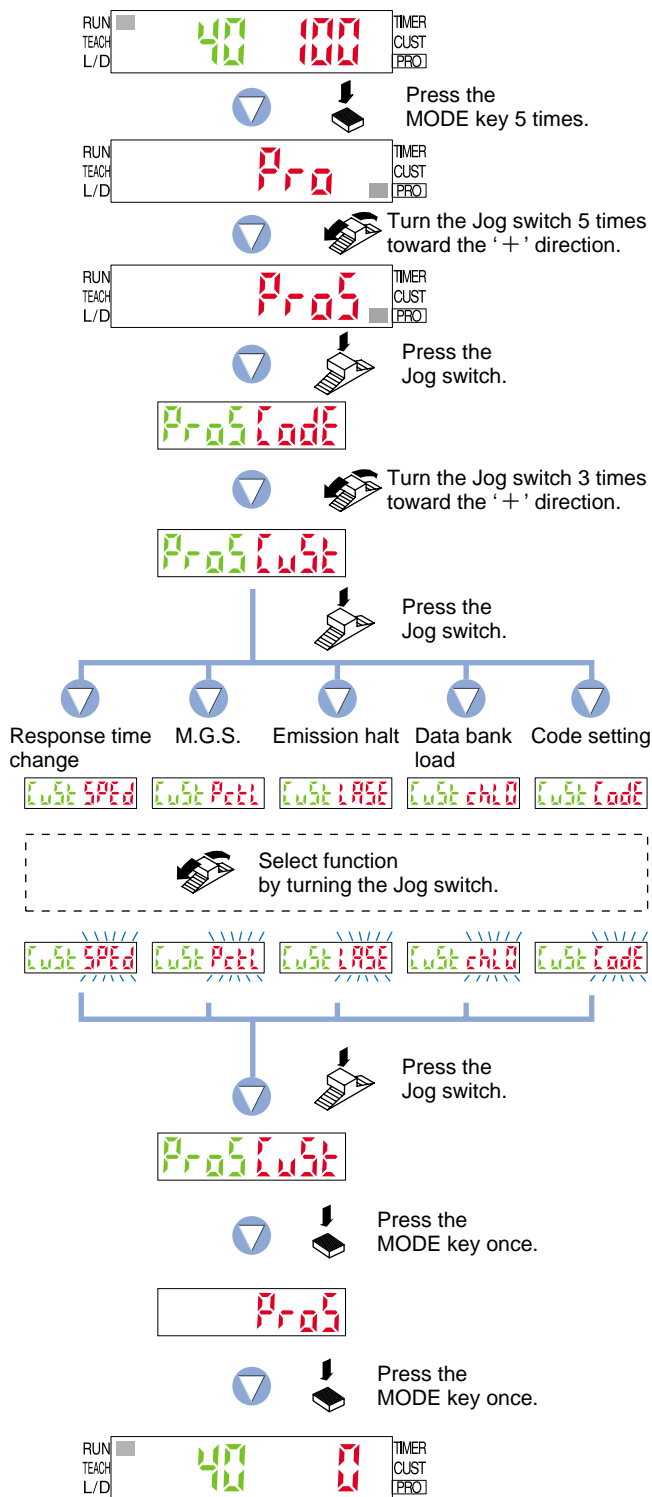

- ① Press the [MODE key] 5 times to select 'PRO mode'.
- ② Turn the [Jog switch] 5 times toward the '+' direction, to select 'PRO5 mode'.
- ③ Press the [Jog switch] to enter the 'code setting' state.
- ④ Turn the [Jog switch] 3 times toward the '+' direction, to enter the 'CUSTOM mode display selection' state.
- ⑤ If the [Jog switch] is pressed, the current CUSTOM mode setting (red) will be displayed.
* The factory setting is 'Response time change'.
- ⑥ If the [Jog switch] is turned, the CUSTOM mode (red) will blink on the digital display.
Select the desired function to display in CUSTOM mode.
- ⑦ If the [Jog switch] is pressed, the setting will be confirmed.
- ⑧ If the [MODE key] is pressed once, the amplifier will return to 'PRO5 mode'.
- ⑨ Press the [MODE key] once, the amplifier will return to 'RUN mode' (normal sensing operation).

10 PRO6 Mode

10-1. PRO6 Mode Functions and Settings

PRO6 mode is used to set sensing mode (normal / window comparator / rising differential / trailing differential / hysteresis) and also to set the shift amounts in window comparator mode and hysteresis mode.

 : **Normal Mode**

Refer to p. 53 for setting procedure

This is a sensing mode for setting a single 'threshold value' and turning output ON or OFF.

 : **Window Comparator Mode**

Refer to p. 53 for setting procedure
Output 1 can only be set.

This is a sensing mode for setting two threshold values and tuning output ON or OFF within the set range.

The teaching method can be selected from 1-level teaching, 2-level teaching or 3-level teaching.

 : **Rising differential /
Trailing differential Mode**

Refer to p. 53 for setting procedure
Output 1 can only be set.

This is a mode for canceling out gradual changes in light intensity, so that only sudden changes are sensed when the incident light intensity increases or decreases.

 : **Hysteresis Mode**

Refer to p. 53 for setting procedure
Output 1 can only be set.

This is a sensing mode for varying the hysteresis in order to cancel out minute changes in light intensity.

The teaching method can be selected from 1-level teaching, 2-level teaching or 3-level teaching.

10-2. Output 1 Sensing Mode Settings

Output 1 can be set to one of five sensing modes (normal / window comparator / rising differential / trailing differential / hysteresis).

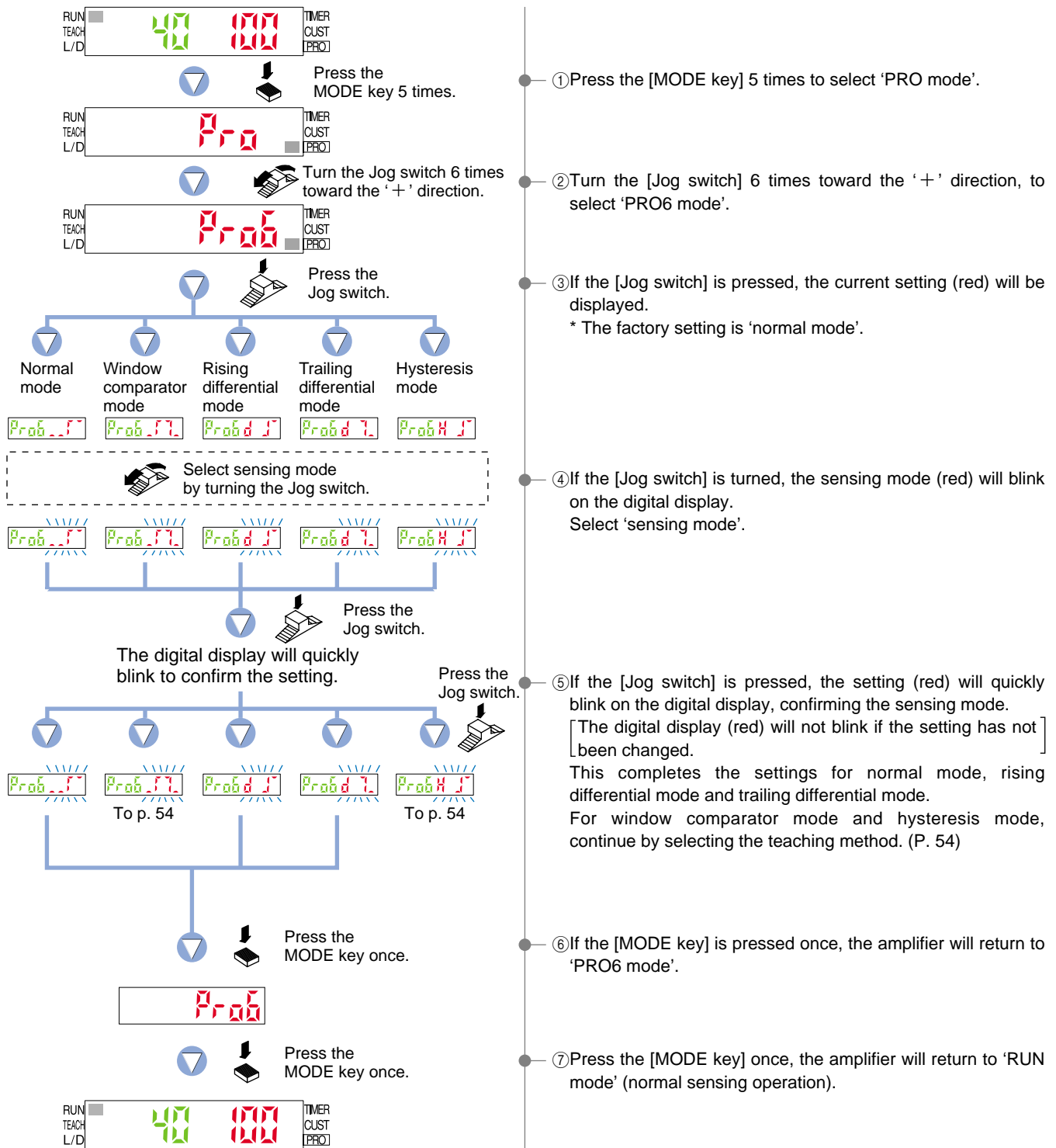

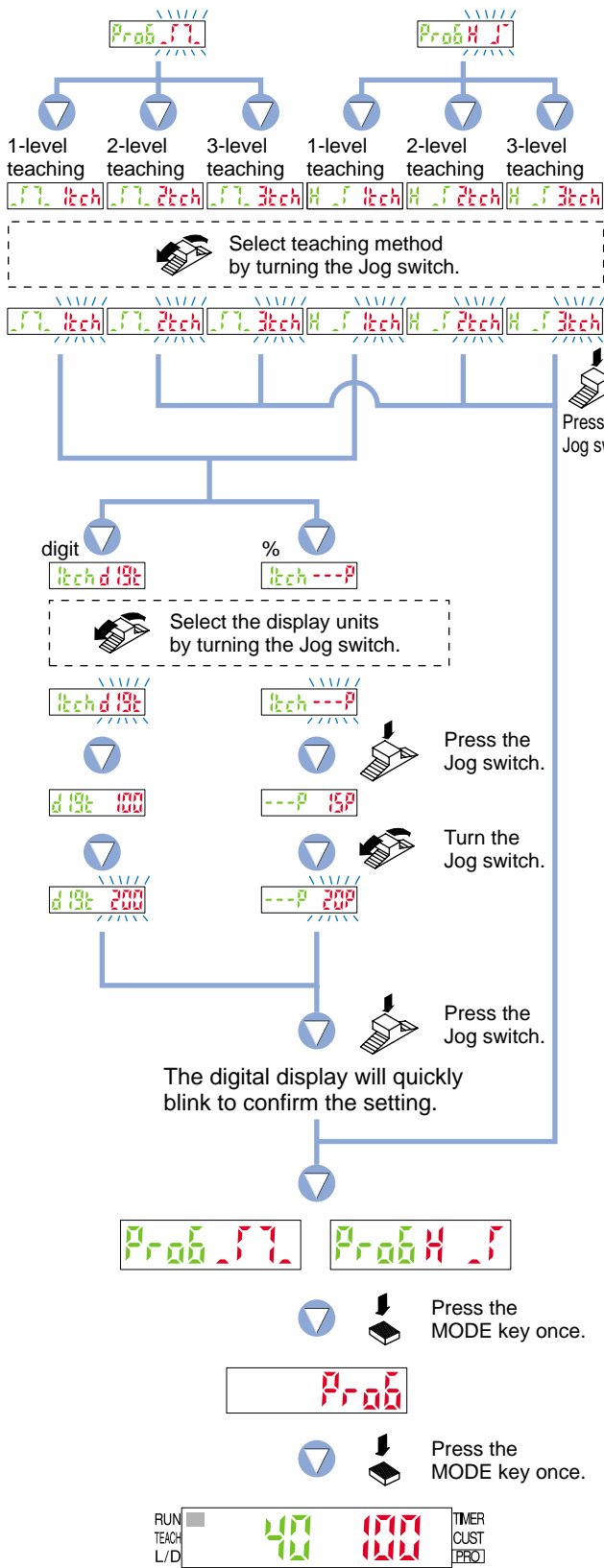

- ⑧ If the [Jog switch] is turned, the teaching method (red) will blink.
- ⑨ If the [Jog switch] is pressed, the teaching method will be confirmed. For 1-level teaching, continue by selecting the shift amount.
- ⑩ Turn the [Jog switch] to select the display units. (1-level teaching only)
- ⑪ If the [Jog switch] is pressed, the display units will be confirmed. (1-level teaching only)
- ⑫ Turn the [Jog switch] to set the shift amount. (1-level teaching only)
- ⑬ If the [Jog switch] is pressed, the shift amount setting value (red) will quickly blink, confirming the setting.
- ⑭ If the [MODE key] is pressed once, the amplifier will return to 'PRO6 mode'.
- ⑮ Press the [MODE key] once, the amplifier will return to 'RUN mode' (normal sensing operation).

10-3. Output 2 Sensing Mode Settings

Output 2 can only be set to normal mode.

Press the MODE key for 2 seconds or more to make the Select 2 indicator illuminate beforehand.

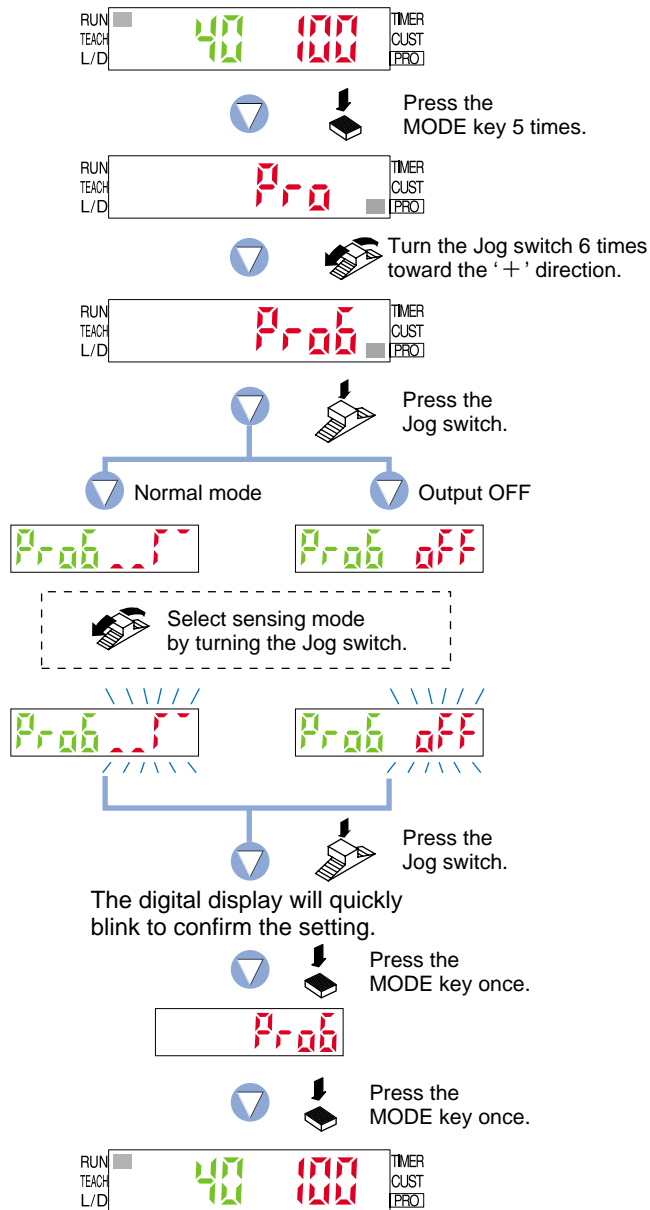

- ① Press the [MODE key] 5 times to select 'PRO mode'.
- ② Turn the [Jog switch] 6 times toward the '+' direction, to select 'PRO6 mode'.
- ③ If the [Jog switch] is pressed, the current setting (red) will be displayed.
* The factory setting is 'normal mode'.
- ④ Turn the [Jog switch], the sensing mode (red) will blink on the digital display.
Select from either 'normal mode' or 'output OFF'.
- ⑤ If the [Jog switch] is pressed, sensing mode (red) will quickly blink on the digital display, confirming the sensing mode.
- ⑥ If the [MODE key] is pressed once, the amplifier will return to 'PRO6 mode'.
- ⑦ Press the [MODE key] once, the amplifier will return to 'RUN mode' (normal sensing operation).

11 Others

11-1. Key Lock Function

The 'key lock function' prevents operators from changing the sensor settings by mistake.

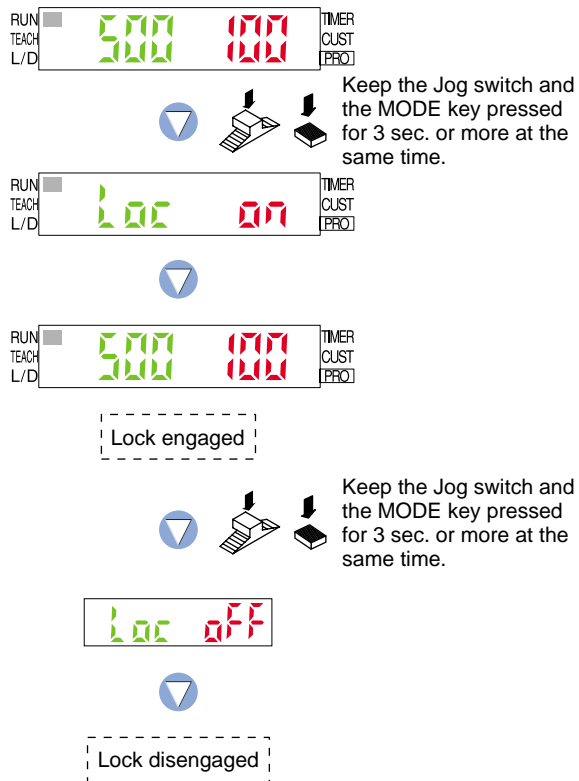

- ① Keep the [MODE key] and the [Jog switch] pressed for 3 sec. or more at the same time in 'RUN mode' condition.
- ② 'Loc ON' will be displayed, and the key lock function will be set to ON.
- ③ Key operations will be locked.
- ④ To disengage the lock function, keep the [MODE key] and the [Jog switch] pressed for 3 sec. or more at the same time once again.
- ⑤ 'Loc OFF' will be displayed, and the key lock function will be set to OFF.