

# Panasonic INSTRUCTION MANUAL

Digital Fiber Sensor

**FX-100-Z Series**

MEUEN-FX100Z V1.0

Thank you for purchasing products from Panasonic Electric Works SUNX Co., Ltd. Please read this Instruction Manual carefully and thoroughly for the correct and optimum use of this product. Kindly keep this manual in a convenient place for quick reference.

## WARNING

- Never use this product as a sensing device for personnel protection.
- In case of using sensing devices for personnel protection, use products which meet laws and standards, such as OSHA, ANSI or IEC etc., for personnel protection applicable in each region or country.

## 1 CAUTIONS

- This product has been developed / produced for industrial use only.
- Make sure that the power supply is off while wiring.
- If a voltage exceeding the rated range is applied, or if an AC power supply is directly connected, the product may get burnt or damaged.
- Short-circuiting the load or incorrect wiring may burn or damage the product.
- Do not run the wires together with high-voltage lines or power lines or put them in the same raceway. This can cause malfunction due to induction.
- Verify that the supply voltage variation is within the rating.
- If power is supplied from a commercial switching regulator, ensure that the frame ground (F.G.) terminal of the power supply is connected to an actual ground.
- If noise generating equipment (switching regulator, inverter motor, etc.) is used in the vicinity of this product, connect the frame ground (F.G.) terminal of the equipment to an actual ground.
- Do not use during the initial transient time (0.5s) after the power supply is switched on.
- You can extend the cable up to 100m max. with 0.3mm<sup>2</sup> or more cable. However, in order to reduce noise, make the wiring as short as possible.
- Make sure that stress is not applied to the sensor cable joint, e.g. by forcible bending or pulling.
- Take care that the product is not directly exposed to fluorescent lamp from a rapid-starter lamp, a high frequency lighting device or sunlight, etc. as it may affect the sensing performance.
- This product is suitable for indoor use only.
- Avoid dust, dirt, and steam.
- Take care that the product does not come in contact with oil, grease, organic solvents, such as thinner, etc., strong acid or alkalines.
- This product cannot be used in an environment containing inflammable or explosive gases.
- Never disassemble or modify the product.
- EEPROM is adopted to this product. Teaching is limited to 100,000 times because of the EEPROM's lifetime.

## 2 PART DESCRIPTION

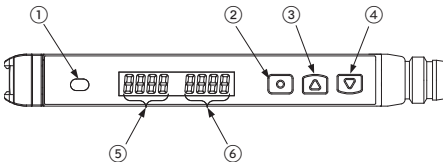

No.	Part	Description
①	Output indicator (orange)	Lit when output is active.
②	Mode key	<ul style="list-style-type: none"> <li>• Select mode</li> <li>• Confirm settings</li> </ul>
③	ON key / Set value UP key	<ul style="list-style-type: none"> <li>• Select settings in teaching mode</li> <li>• Increase set value</li> <li>• Select various other settings</li> </ul>
④	OFF key / Set value DOWN key	<ul style="list-style-type: none"> <li>• Select settings in teaching mode</li> <li>• Decrease set value</li> <li>• Select various other settings</li> </ul>
⑤	Green digital display	Threshold value

No.	Part	Description
⑥	Red digital display	Incident light intensity

## 3 MOUNTING

### When using a DIN rail

You may break the spring hook if you do not follow the mounting instructions carefully.

#### How to mount the amplifier

- ① Fit the spring hook on a 35mm DIN rail and push forward.
- ② Slip the front part of the mounting section over the DIN rail and release.

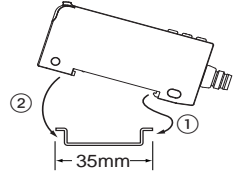

#### How to remove the amplifier

- ① Push the amplifier forward.
- ② Lift up the front part of the amplifier.

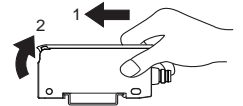

### When using screws with washers

Use M3 screws with washers to mount the amplifier.

Do not use a tightening torque of more than 0.5 N·m or you may break the housing.

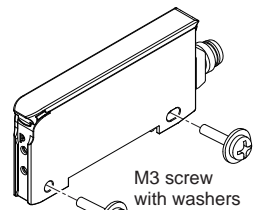

### How to connect the fiber cable

Be sure to fit the attachment to the fibers first before inserting the fibers into the amplifier. For details, refer to the Instruction Manual enclosed with the fibers.

- ① Snap the fiber lock lever down until it stops completely.
- ② Slowly insert the fiber cables into the inlets until they stop (see note).  
If the fiber cables are not inserted until they stop, the sensing range reduces.  
**Since a flexible fiber is easily bent, be careful when inserting it.**
- ③ Return the fiber lock lever to the original position.

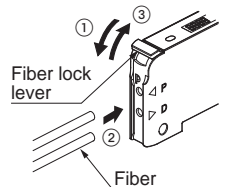

If the cable is a coaxial reflective type fiber, e.g. FD-G4 or FD-FM2, insert the single-core fiber cable into the beam-emitting inlet "P" and the multi-core fiber cable into the beam-receiving inlet "D." If they are inserted in reverse, the sensing performance will deteriorate.

## 4 WIRING

- Use the cable with the connector **CN-24A-C□** (optional) when connecting this product.
- Tighten the fixing ring of the cable with connector completely by hand when mounting. The tightening torque: 0.3 to 0.4N·m.
- Make sure to hold the side surface of this product when tightening or loosening the fixing ring of the cable with connector.
- If the fixing ring is tightened by a tool such as pliers, the connector may be damaged.
- If the tightening torque is not enough, the fixing ring may loosen due to vibration, etc.

### Attaching the connector cable

#### Connection method

Insert the cable with connector **CN-24A-C□** as shown. Tighten the fixing ring.

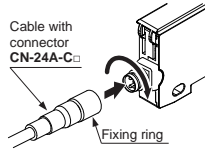

#### Disconnection method

Loosen the fixing ring, and, holding the fixing ring, pull to separate the connector.

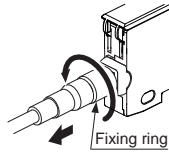

- **Before disconnecting the cable, loosen the fixing ring completely. If the cable is pulled by excessive force (15N or more) when the fixing ring is tightened, the cable may break.**

### Connector pin arrangement

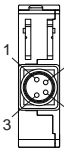

Connector pin No.	Terminal name
1	+V
2	External input
3	0V
4	Output

## 5 I/O CIRCUIT DIAGRAMS

### NPN output type

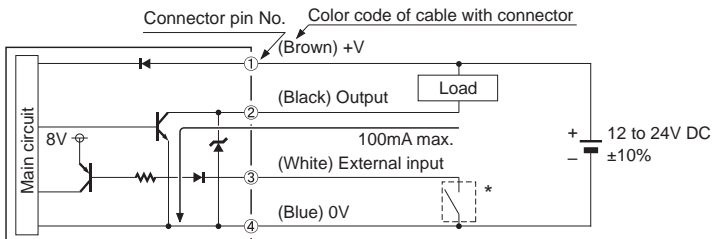

\* Non-voltage contact or NPN open-collector transistor

- High (+8V to +V DC or Open): Invalid
- Low [0 to +2V DC (source current 0.5mA or less)]: Valid

### PNP output type

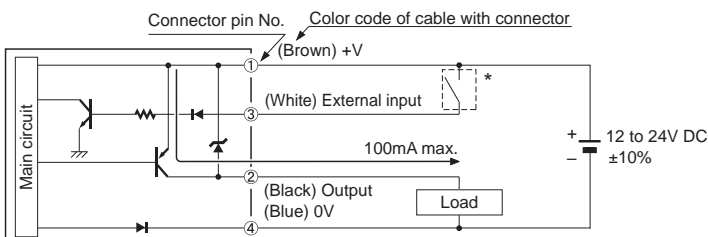

\* Non-voltage contact or PNP open-collector transistor

- High [+4V to +V DC (Sink current 0.5 to 3mA or less)]: Valid
- Low (0 to +0.6V DC or Open): Invalid

## 6 RUN MODE

### Digital display

When you turn ON the power, the product name is indicated in green and the emission frequency is indicated in red. Then the device automatically switches into RUN mode, in which the threshold value is displayed in green and the incident light intensity in red.

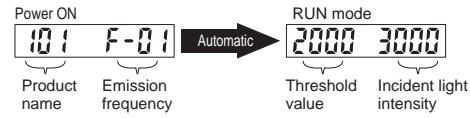

- **What appears on the display is effected by the settings for the external input and ECO mode. For details, see PRO MODE on page 4.**

### Threshold value fine adjustment function

Change the threshold value in RUN mode by pressing <UP> or <DOWN>. Hold down the key to make the value change faster. The threshold value is stored after 3s.

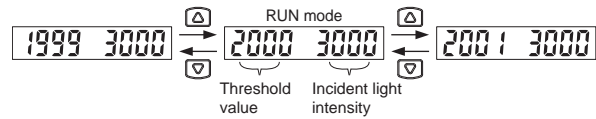

### Key lock function

The key lock function prevents settings from being changed inadvertently. Loc on is displayed if you press a key when the key lock function is set.

Press <MODE> + <DOWN> for at least 2s to set or release the key lock function.

#### Set key lock

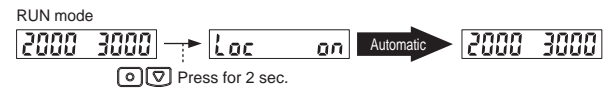

#### Release key lock

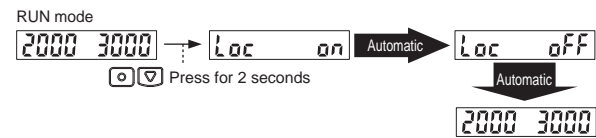

## 7 SETTING MODE

To enter SETTING mode, press <MODE> for 2s in RUN mode. While in SETTING mode, press <MODE> briefly to move from one selection to the

Item	Factory setting	Description
Teaching	Teach	A threshold value can be set in 2-point teaching, limit teaching or full-auto teaching. For details, see <b>TEACHING MODE</b> on page 7.
Output operation	Light-on	Light-ON or Dark-ON can be set. <ul style="list-style-type: none"> <li>• <b>Light-ON</b> means the output will turn ON when the incident light intensity is in the brighter of the two 2 sensing states (object present/object absent).</li> <li>• <b>Dark-ON</b> means the output will turn ON when the incident light intensity is in the darker of the two 2 sensing states (object present/object absent).</li> </ul>
Timer selection	Delay non	Three settings are possible: no timer, ON delay timer, or OFF delay timer.
Timer delay	On 10 Off 10	You can specify the delay for the ON delay timer or OFF delay timer. If no timer is set, this mode is not displayed.

Item	Factory setting	Description
Emission level	PcLl 11111	If the incident light intensity is saturated, which makes sensing impossible or unreliable, you can reduce the emission level. <ul style="list-style-type: none"> <li>Level 3 (11111): Normal</li> <li>Level 2 (1111): Approx. 40% of normal</li> <li>Level 1 (11): Approx. 20% of normal</li> </ul> When you select Auto (A), proper light intensity is automatically set only during limit teaching. <p>➤ For differences between the conventional and modified units, see <b>UNIT VERSIONS</b> on page 7.</p>
Emission frequency	FX-101□-Z FrE9 F-0 FX-102□-Z FrE9 F-01	When using fiber heads in parallel, interference can be prevented by setting different emission frequencies. When emission frequency 0 is set, interference cannot be prevented. Response time corresponds to emission frequency. For details, see <b>SPECIFICATIONS</b> on page 8.

### Flowchart for SETTING mode

#### RUN mode

2000 3000

↓ [ON] Press for 2s.

#### SETTING mode

SEt

Automatic

#### Teaching

LRch 2000

↓ [ON]

#### Output operation

L.d d.on → L.d L.on  
Dark-ON → Light-ON

↓ [ON]

#### Timer operation

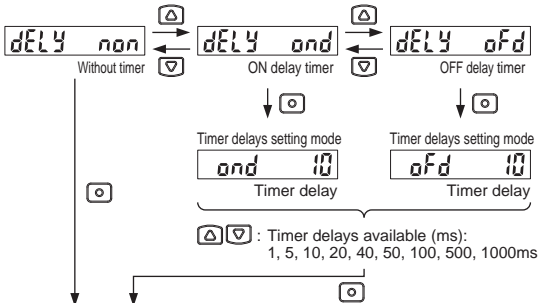

#### Emission level

PcLl 11111 → PcLl 111 → PcLl 11 → PcLl 1111A  
Level 3 → Level 2 → Level 1 → Auto + Level 3

↓ [ON]

#### Emission frequency

FX-101□-Z: FrE9 F-0 (Emission frequency 0)

FX-102□-Z: FrE9 F-01 (Emission frequency 1)

FX-101□-Z: FrE9 F-01, F-02, F-03 (Emission frequencies available)

FX-102□-Z: FrE9 F-01, F-02, F-03, F-04 (Emission frequencies available)

➤ The operation indicator and the beam-emitting inlet blink while the emission frequency is being set. When the emission frequency is set to 0, they light up. The blinking cycle depends on each emission frequency (emission frequency 1: fast ↔ emission frequency 4: slow).

↓ [ON]

#### RUN mode

2000 3000

## 8 TEACHING MODE

➤ Beware that detection may become unstable if too little margin between the threshold value and incident light intensity is allowed for the environment when teaching.

### 2-point teaching

2-point teaching is the most common teaching method and means the threshold value is taught using two points that correspond to the object present and object absent conditions.

Light-ON or Dark-ON is determined automatically for the output operation setting.

#### Output indicator ON when object is present

LRch 2000

In teaching mode, press <ON> when object is present to set the first incident light intensity.



Thru-beam type  
Light interrupted condition

Reflective type  
Mark Base  
Light received condition

2000

The first incident light intensity is set and is displayed in green. The red LED display blinks and is ready to be set to the object absent condition.

Automatic

To cancel, press <MODE>.

2000 3000



Remove the object and press <OFF> to complete 2-point teaching.

Thru-beam type  
Light received condition

Reflective type  
Mark Base  
Light interrupted condition

2500 25P

The margin between the first and second incident is displayed in red (P=%). When the margin is 200% or more, Full is displayed.

Automatic

LRch 3000

#### Output indicator ON when object is absent

LRch 3000

In teaching mode, press <ON> when object is absent to set the first incident light intensity.



Thru-beam type  
Light received condition

Reflective type  
Mark Base  
Light interrupted condition

3000

The first incident light intensity is set and is displayed in green. The red LED display blinks and is ready to be set to the object present condition.

Automatic

To cancel, press <MODE>.

3000 2000



Place the object so that it is sensed and press <OFF> to complete 2-point teaching.

Thru-beam type  
Light interrupted condition

Reflective type  
Mark Base  
Light received condition

2500 25P

The margin between the first and second incident is displayed in red (P=%). When the margin is 200% or more, Full is displayed.

Automatic

LRch 2000

## Limit teaching

Limit teaching is used to set the threshold value for the **object absent condition only**, i.e. for a stable incident light condition.

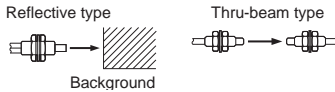

This method is used to detect objects in the presence of a background body or to detect small objects.

In teaching mode:

- For the **thru-beam type**, press <OFF>. Press <OFF> again after the reference intensity light is displayed in green and the red LED is blinking. The shift amount is fixed above this value.
- For the **reflective type**, press <ON>. Press <ON> again after the reference intensity light is displayed in green and the red LED is blinking. The shift amount is fixed below this value.

When you complete these settings, the threshold value is displayed in green, and the shift amount is displayed briefly in red, e.g. 15P = 15%. When the margin is 200% or more, FULL is displayed. You can specify the shift amount in **PRO MODE**.

When you select "Auto" (R) for the emission level, proper light intensity will be set automatically.

## Full auto-teaching

Full auto-teaching is used when you want to set the threshold value without stopping the assembly line.

In teaching mode, press and hold <ON> or <OFF>. After 2s, "Auto" is displayed in green and the sensor starts sampling incident light intensity. The threshold value is set when you release <ON> or <OFF>.

## 9 PRO MODE

In RUN mode, press <MODE> for 4s to select PRO mode.

Item	Factory setting	Description
Shift	SHIFT 15P	For limit teaching (+, -) or the threshold value follow-up cycle, you can shift, i.e. offset, the threshold value by 0 to 80%. When shift value is set to 0%, the present incident light intensity = threshold value.
External input	input E-off	For external input you can select: <ul style="list-style-type: none"> <li>Emission halt</li> <li>2-point teaching</li> <li>Limit teaching</li> <li>Full-auto teaching</li> <li>ECO (note 1)</li> <li>Incident light intensity test</li> </ul> For differences between the conventional and modified units, see <b>UNIT VERSIONS</b> on page 7. If you have selected incident light intensity test TEST, the output turns ON/OFF every 100ms when the difference between the incident light intensity and threshold value is less than half of the shift amount. For example, the shift amount is set to 20%. The difference between incident light intensity (e.g. 1000) and threshold value (e.g. 1050) is less than 10%.
Threshold value-storage (note 2)	b-up OFF	The threshold value set during 2-point teaching, limit teaching, full-auto teaching by external input is stored. If you select "Auto" for the emission level, the emission level is also stored.
Threshold value follow-up cycle (note 3)	cycle OFF	The incident light intensity can be monitored for the cycle specified, for example when variations in incident light intensity are expected. When the threshold value follow-up cycle is set, the threshold value is adjusted according to the shift based on the incident light intensity detected. However, the threshold value is not stored.
GETA function (note 4, 5)	GETA OFF	Variations can be reduced by setting the present incident light intensity for each amplifier to a certain value. For example, if this value is set to 2,000 and the incident light intensity is 1,500, activating the GETA function sets the incident light intensity to 2,000. You can set values in steps of 100 from 0 to 2,000.

Item	Factory setting	Description
ECO mode	ECO OFF	When ECO mode is ON, the display turns off after 20s in RUN mode. To reactivate the display, press any key for 2s.
Invert digital display	turn OFF	Invert the digital display.
Alert for insufficient threshold margin	RLrt OFF	The amplifier can issue an alert if the margin between the threshold value and the incident light intensity is too small. <ul style="list-style-type: none"> <li>urEn, green blinks.</li> <li>red, red blinks.</li> <li>RLt, red and green blink.</li> <li>int, when conducting limit teaching or 2-point teaching by external input, the output turns ON/OFF every 100ms if: <ul style="list-style-type: none"> <li>the ratio between the reference incident light intensity and threshold value is less than half of the shift amount</li> <li>the threshold value is out of range, i.e. above 4000 or below 0 (note 6).</li> </ul> For differences between the conventional and modified units, see <b>UNIT VERSIONS</b> on page 7.</li> </ul>
Copy function	copy no	The settings of the master amplifier can be copied to the slave amplifier. See <b>COPY FUNCTION</b> on page 6.
Reset	reset no	Resets to default (factory) settings.

- When ECO is selected for the external input setting, key operation on the main body is invalid during external input.
- TEST, Ltc-, Ruto or Z-pt must be set for the external input in order to select threshold value storage.
- If the incident light intensity becomes 300 or less, the follow-up operation stops and the threshold value (green) blinks. Do not use the reflective type fiber for this function.
- When the GETA function is set, pressing <MODE> in RUN mode indicates the actual incident light intensity in red for 2s.
- The GETA function will not take effect if the incident light intensity is saturated (4,000). HRRd is indicated in red.
- LtcP, Ltc- or Z-pt must be set for the external input in order to select this option.

## Flowchart for PRO mode

### RUN mode

2000 3000

Press for 4s.

### PRO mode

Pro



### Shift setting

SHIFT 15P (15%)

Shift range, 0 to 80%

Press for 4s.

### External input

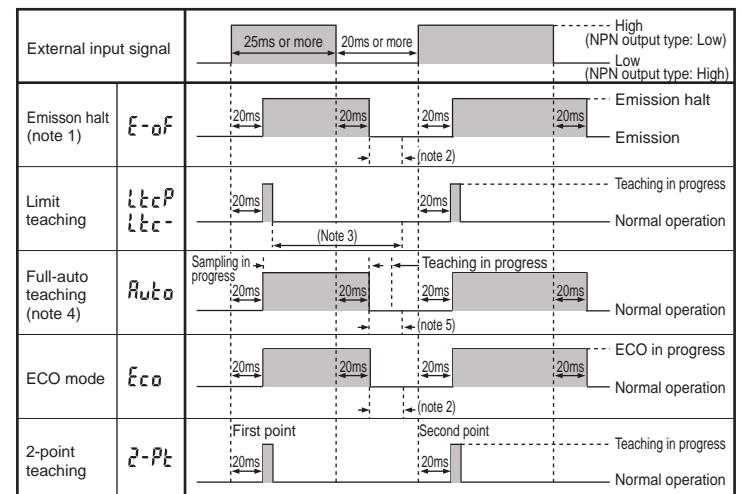

## Threshold follow-up cycle

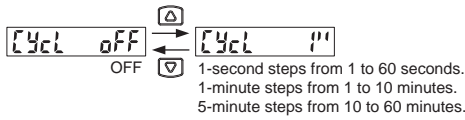

## GETA function

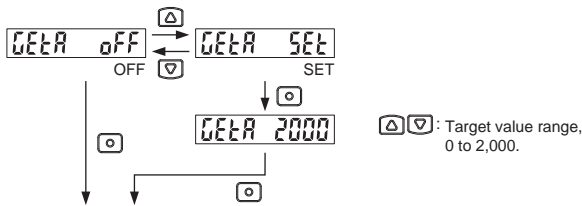

## ECO mode

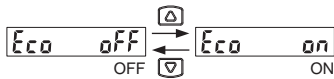

## Invert digital display

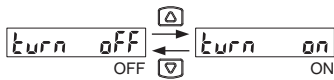

## Alert for too little margin between threshold value and incident light intensity

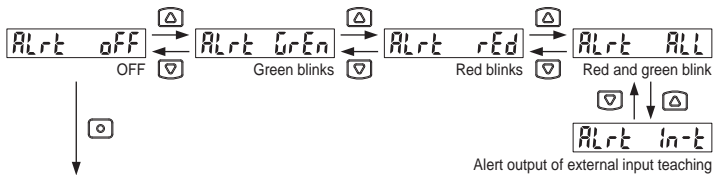

Alert output for external input teaching does not operate unless limit or 2-point teaching is set for the external input.



## Copy function

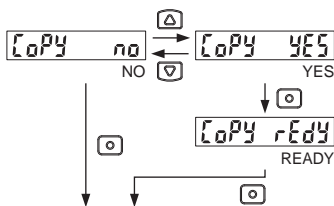

Press <MODE> for 2s to cancel copying.



## Reset



## RUN mode



## 10 EXTERNAL INPUT

- When you have selected emission halt for the external input setting and an external signal is received,  $E-aF$  is displayed in red.
- When you have selected ECO for the external input setting, you cannot operate the keys <MODE>, <ON> or <OFF>.
- When you have selected 2-point teaching for the external input setting,  $2-Pt$  is displayed in green after the first point is input.
- To make settings for the external input, see **PRO MODE** on page 4.
- To issue an alert for an insufficient margin between the threshold value and incident light intensity, see **PRO MODE** on page 4.

### Time chart

External input signal		25ms or more	20ms or more	High (NPN output type: Low)	Low (NPN output type: High)
Emission halt (note 1)	$E-aF$	20ms	20ms	Emission halt	Emission
Limit teaching	$LtCP$ $LtC-$	20ms	(Note 3)	Teaching in progress	Normal operation
Full-auto teaching (note 4)	$AutO$	Sampling in progress	20ms	Teaching in progress	Normal operation
ECO mode	$ECO$	20ms	20ms	ECO in progress	Normal operation
2-point teaching	$2-Pt$	20ms	20ms	First point	Second point

1. Depending on the threshold value, output may turn ON/OFF when emission is halted or released.
2. When emission starts, output operation is undetermined during the response time. If the output signal is received by a PLC, for example, set the amplifier's timer to 20ms response time or greater. **Example:** For the FX-101□-Z with emission frequency 0 (response time 250μs or less), **total timer period** = 20ms + 0.25ms (250μs) = 20.25ms.
3. After teaching is complete, output operation is undetermined during the response time. If the output signal is received by a PLC, for example, set the amplifier's timer to the amplifier response time or greater. The threshold value will be set based on the incident light intensity at the instant when teaching is verified.
4. Move the object to be sensed past the sensor once while the external input signal is ON.
5. After teaching is complete, output operation is undetermined during the response time. If the output signal is received by a PLC, for example, set the amplifier's timer to the amplifier response time or greater.

External input signal		25ms or more	20ms or more	High (NPN output type: Low)	Low (NPN output type: High)
Limit teaching		20ms	20ms	Teaching in progress	Normal operation
Operation when alert output is selected for external input teaching: $in-t$		100ms	100ms	ON	OFF
2-point teaching		20ms	20ms	First point	Second point
Operation when alert output is selected for external input teaching: $in-t$			100ms	ON	OFF

1. If the margin is not sufficient, the output turns ON/OFF every 100ms while the external input signal is ON after teaching.
2. If the margin is not sufficient, the output turns ON/OFF every 100ms while the external input signal is ON after the second point is taught.



## 11 COPY FUNCTION

Use the copy function to copy settings from 1 master amplifier to 1 slave amplifier. The models must be **identical!**

The following settings can be copied: threshold value, output operation, timer operation, timer delay, emission level, shift, external input, threshold value storage, ECO, invert digital display, and threshold value margin.

### Procedure, set copy function

In **PRO MODE** of the master amplifier, turn on the setting copy function by pressing <MODE> until **Copy ready** is displayed. The sensor is in the copy ready state.

- Turn off the master amplifier.
- Connect the master amplifier and the slave amplifier as shown.

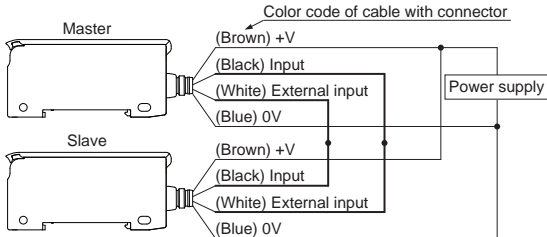

- Turn on the master amplifier and the slave amplifier at the same time (see note)!
- On the master amplifier, **Copy** is displayed in green and the 4-digit code in red. Copying starts.
- When copying is completed, **Good** is displayed in green on the slave amplifier and the same 4-digit code as the master amplifier is displayed in red.
- Turn off the power of the master amplifier and the slave amplifier and disconnect the wire.

**To copy settings to another amplifier, repeat steps 3 to 7.**

**If the power is not turned on at the same time, the setting contents may not be copied.**

### To cancel the setting copy function of the master amplifier

- While the slave side amplifier is disconnected, turn on the power of the master side amplifier.
- Press <MODE> for 2s.

## 12 QUICK SETTING FUNCTION

Simply by selecting a quick setting number, which are listed in the table at the end of this section, you can set: output operation, emission level, timer, and emission frequency.

### RUN mode

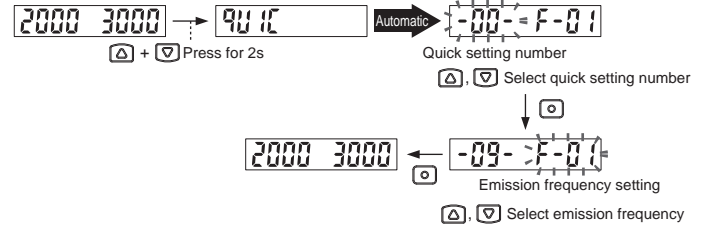

During the setting process, press <MODE> for 2s to cancel and return to RUN mode.

When the present setting does not correspond to a quick setting number, **-88-** is displayed and the set content is not changed.

Table of quick setting numbers

No.	Output operation	Emission amount setting		Timer
		FX-100□-Z modified Level	FX-100□-Z conventional ON/OFF	
-00-	D-on	3	OFF	non
-01-	D-on	2	ON	non
-02-	D-on	3	OFF	ofd 10ms
-03-	D-on	2	ON	ofd 10ms
-04-	D-on	3	OFF	ofd 40ms
-05-	D-on	2	ON	ofd 40ms
-06-	D-on	3	OFF	ond 10ms
-07-	D-on	2	ON	ond 10ms
-08-	D-on	3	OFF	ond 40ms
-09-	D-on	2	ON	ond 40ms
-10-	L-on	2	ON	ond 40ms
-11-	L-on	3	OFF	ond 40ms
-12-	L-on	2	ON	ond 10ms
-13-	L-on	3	OFF	ond 10ms
-14-	L-on	2	ON	ofd 40ms
-15-	L-on	3	OFF	ofd 40ms
-16-	L-on	2	ON	ofd 10ms
-17-	L-on	3	OFF	ofd 10ms
-18-	L-on	2	ON	non
-19-	L-on	3	OFF	non

## 13 CODE SETTING FUNCTION

Selecting codes allow you to set: output operation, timer, emission level, emission frequency, ECO, external input, and shift amount.

The factory setting is 0002.

### RUN mode

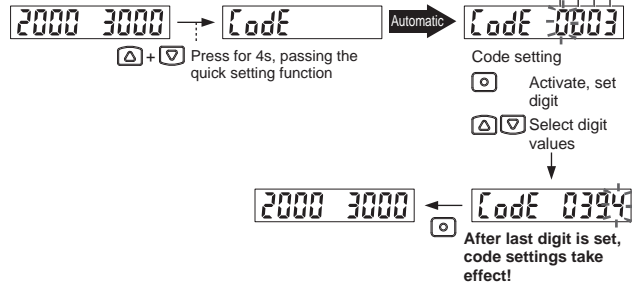

During the setting process, press <MODE> for 2s to cancel and return to RUN mode. After the last digit is set, code settings take effect!

### Code table, modified unit

Code	1st digit		2nd digit		3rd digit		4th digit	
	Output operation	Timer (see note)	Emission amount level	Emission frequency		ECO	External input	Shift (see note)
				FX-101□-Z	FX-102□-Z			
0	D-on	non	3	0	1	OFF	E_oF	5%
1		ond 10ms		1	2		LtcP	10%
2		ond 40ms		2	3		Ltc-	15%
3		ofd 10ms		3	4		Auto	20%
4	L-on	ofd 40ms	2	0	1	ON	Eco	25%
5		non		1	2		E_of	30%
6		ond 10ms		2	3		LtcP	35%
7		ond 40ms		3	4		Ltc-	40%
8	Auto	ofd 10ms	1	0	1	OFF	Auto	45%
9		ofd 40ms		1	2		Eco	50%
A		2		3	2-Pt		Incident light intensity test	
b		3		4				
c	Auto	0	1	ON	2-Pt	Incident light intensity test		
d		1	2					
E		2	3					
F		3	4					

### Code table, conventional unit

Code	1st digit		2nd digit		3rd digit		4th digit	
	Output operation	Timer (see note)	Emission amount setting	Emission frequency		ECO	External input	Shift (see note)
				FX-101□-Z	FX-102□-Z			
0	D-on	non	OFF	0	1	OFF	E_oF	5%
1		ond 10ms		1	2		LtcP	10%
2		ond 40ms		2	3		Ltc-	15%
3		ofd 10ms		3	4		Auto	20%
4	L-on	ofd 40ms	ON	0	1	ON	Eco	25%
5		non		1	2		E_of	30%
6		ond 10ms		2	3		LtcP	35%
7		ond 40ms		3	4		Ltc-	40%
8	Auto	ofd 10ms					Auto	45%
9		ofd 40ms					Eco	50%

For differences between the conventional and modified units, see UNIT VERSIONS on page 7.

## 14 ERROR INDICATION

If the follow error codes are displayed, please take appropriate measures.

Display	Error description	Measures
Er-0	EEPROM writing error	Contact our office.
Er-1	The load is short-circuited causing overcurrent.	Turn off the power, then check the load.
Er-5	Communication error Disconnection, connection failure, etc.	Check the wiring before using the setting copy function.

## 15 UNIT VERSIONS

Please note the difference between the modified unit and the conventional unit: the modified unit has a "P" mark near the beam emitting inlet. The conventional unit has no "P" mark.

### Modified unit

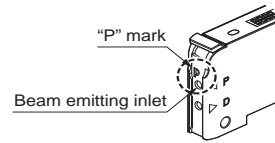

### Conventional unit

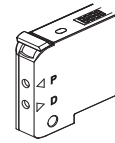

The modified unit has some additional functionality.

- The emission level has 4 possible settings. For the conventional unit, the emission level can only be turned ON (35%) or OFF.
- For the external input, an incident light intensity test is available.
- For teaching by external input, an additional option is available to turn ON/OFF the output every 100ms. See **PRO MODE** on page 4.
- Due to more functionality, more codes are available. See **CODE SETTING FUNCTION** on page 7.

## 16 SPECIFICATIONS

Item	Standard	Long sensing range
	FX-101-Z (NPN output)	FX-102-Z (NPN output)
	FX-101P-Z (PNP output)	FX-102-PZ (PNP output)
Supply voltage	12 to 24V DC±10% Ripple P-P 10% or less (within the rated range)	
Power consumption	Normal operation: 720mW or less (Current consumption 30mA or less at 24V supply voltage) ECO mode: 600mW or less (Current consumption 25mA or less at 24V supply voltage)	
Output	<b>NPN output type</b> NPN open-collector transistor <ul style="list-style-type: none"> <li>• Maximum sink current: 100mA</li> <li>• Applied voltage: 30V DC or less (between output and 0V)</li> <li>• Residual voltage: 1.5V or less (at 100mA sink current)</li> </ul>	<b>PNP output type</b> PNP open-collector transistor <ul style="list-style-type: none"> <li>• Maximum source current: 100mA</li> <li>• Applied voltage: 30V DC or less (between output and +V)</li> <li>• Residual voltage: 1.5V or less (at 100mA source current)</li> </ul>
Output operation	Light-ON or Dark-ON, selectable	
Short-circuit protection	Incorporated	
External input	<b>NPN output type</b> NPN non-contact input <ul style="list-style-type: none"> <li>• Signal condition: High: +8V to +V DC or Open Low: 0 to +2V DC (Source current 0.5mA or less)</li> <li>• Input impedance: Approx. 10kΩ</li> </ul>	<b>PNP output type</b> PNP non-contact input <ul style="list-style-type: none"> <li>• Signal condition High: +4V to +V DC(Sink current 0.5 to 3mA or less) Low: 0 to +0.6V DC or Open</li> <li>• Input impedance: Approx. 10kΩ</li> </ul>
Response time	<ul style="list-style-type: none"> <li>• Emission frequency 0: 250μs or less</li> <li>• Emission frequency 1: 450μs or less</li> <li>• Emission frequency 2: 500μs or less</li> <li>• Emission frequency 3: 600μs or less</li> </ul>	<ul style="list-style-type: none"> <li>• Emission frequency 1: 2.5ms or less</li> <li>• Emission frequency 2: 2.8ms or less</li> <li>• Emission frequency 3: 3.2ms or less</li> <li>• Emission frequency 4: 5.0ms or less</li> </ul>
Ambient temperature	-10 to +55°C (No dew condensation or icing allowed, see note) Storage: -20 to +70°C	
Ambient humidity	35 to 85% RH, Storage: 35 to 85% RH	
Emitting element	Red LED (peak wavelength = 632nm)	
Material	Enclosure: Polycarbonate, Fiber lock lever: PBT	
Weight	Approx. 15g (Main body only)	

When using the products in parallel, the ambient temperature is as follows: 4 to 7 units: -10 to +50°C, 8 to 16 units: -10 to +45°C

Panasonic Electric Works SUNX Co., Ltd.

<http://panasonic-electric-works.net/sunx>

**Overseas Sales Division (Head Office)**

2431-1 Ushiyama-cho, Kasugai-shi, Aichi, 486-0901, Japan

Phone: +81-568-33-7861 FAX: +81-568-33-8591

**Europe Headquarter: Panasonic Electric Works Europe AG**

Rudolf-Diesel-Ring 2, D-83607 Holzkirchen, Germany

Phone: +49-8024-648-0

**US Headquarter: Panasonic Electric Works Corporation of America**

629 Central Avenue, New Providence, New Jersey 07974, USA

Phone: +1-908-464-3550