

Both compact & robust

## SF4D Series

Safety light curtain

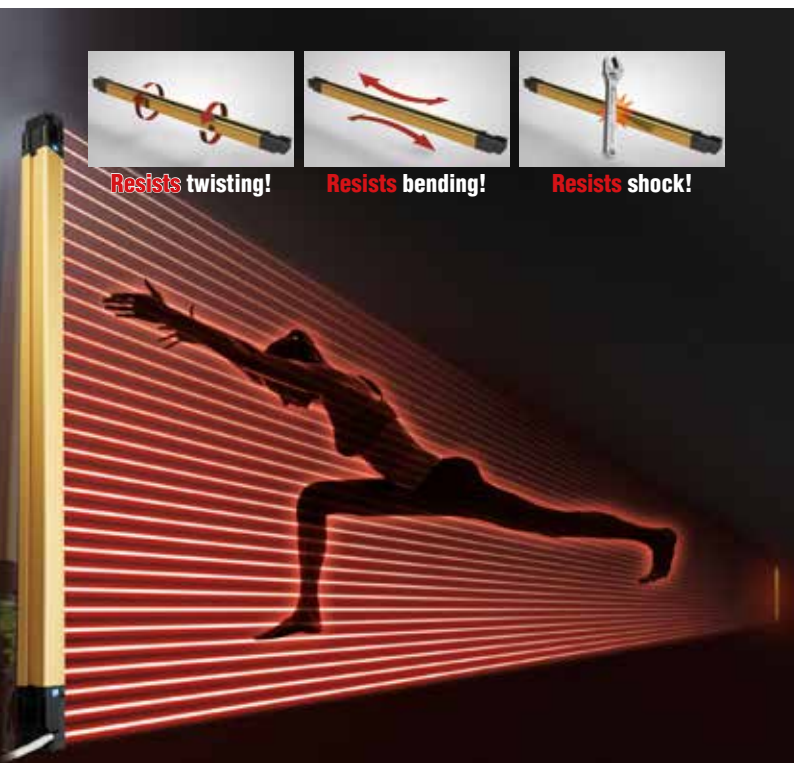

- › Type 4 with very robust aluminum housing
- › Extreme long sensing range up to 15m
- › Integrated PNP and NPN outputs
- › Complies with all common norms and standards
- › No blind zones
- › Finger, hand and arm protection type available in heights of up to 1.9m

Higher stability than SF4B thanks to changes to the interior design

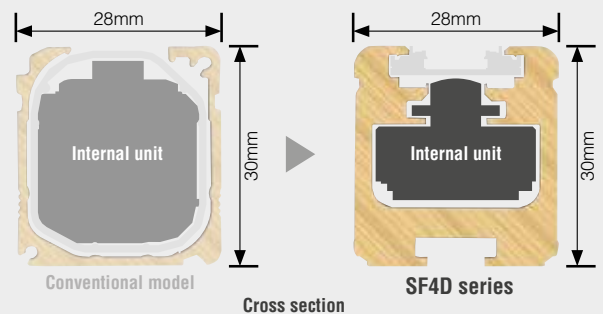

- › OFF response time of one light curtain 10ms
- › Multiple safety light curtains OFF response time 18ms

**➔ Closer mounting to dangerous area possible**

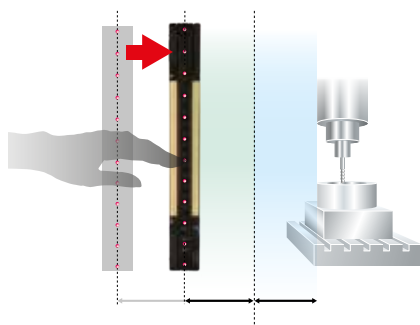



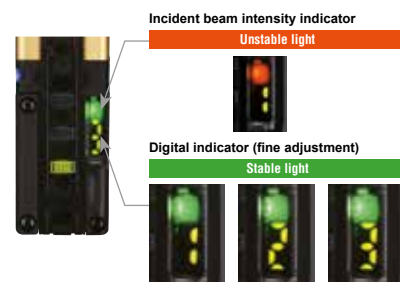

- › Incident beam intensity indicator helps to check if the safety light curtain is well aligned
- › Digital indicator supports fine adjustment for stable or unstable light receiving
- › Errors caused by dirt can be visualized

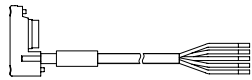
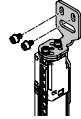
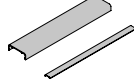

## Specifications

	Finger protection type	Hand protection type	Arm / Foot protection type
Model no.	SF4D-F□	SF4D-H□	SF4D-A□
Safety category	Type 4, Ple, SIL3		
Protective height	150 – 1910mm		
Sensing range	0 – 12m	0 – 15m	
Resolution	10mm	20mm	40mm
Minimum sensing object	Min. Ø 14mm (opaque)	Min. Ø 25mm (opaque)	Min. Ø 45mm (opaque)
Power supply voltage	24V DC +20% -30%		
Response time	ON → OFF: max. 10ms / OFF → ON: max. 50ms		
Control outputs	OSSD1 and OSSD2 (2 x PNP or 2 x NPN open-collector transistor), max. 350mA		
Protection	IP65 (IEC), IP67, NEMA Type 13 (NEMA 250)		
Connection method	Connector (please see our homepage for the complete cable range)		
Dimensions (HxWxD)	Hx28x30mm (H= protective height)		

## Options

Cable	Connection cable (5/8/12 core)	
Mounting bracket	Mounting brackets for various installation possibilities	
Front protection cover	Front protection cover (slim and wide)	 Material: Polycarbonate
Corner mirror	For L- / U-shaped installations with only one safety light curtain	
Communication unit	SFD-TM1 to set and copy settings	
Software	Setting software to be downloaded for free from our homepage	
Safety control unit	SF-C21 Safety control unit with integrated logic functions	

# Panasonic®

## Panasonic Electric Works Europe AG

Robert-Koch-Straße 100 · 85521 Ottobrunn  
 Tel. +49 89 45354-1000 · Fax +49 89 45354-2111  
 info.peweu@eu.panasonic.com  
 www.panasonic-electric-works.com

Copyright © 2017 • Printed in Germany  
 3233 euen 03/17