

# Panasonic

CMOS Type

Micro Laser Distance Sensor

## HG-C SERIES

Application Case Studies

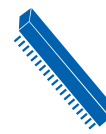

# HG-C Series CMOS Type Micro Laser Distance Sensor Featuring Stable Detection with 10 µm Accuracy

Repeatability



POINT

## Accurate height difference detection

High-precision detection in the 1/100 mm 0.0004 in order.  
High-precision height difference detection and shape detection are now possible.

POINT

## Standard equipped analog output

Analog output is provided in addition to control output. It can be used as a simple measurement sensor.

Analog voltage output 0 to 5 V  
Linearity  $\pm 0.1\%$  F.S., temperature characteristics 0.03 % F.S./°C

POINT

## Ultra compact with built-in amp

POINT

## Robust against color changes

Because the sensor is a distance type, detection is not affected by the color or gloss of workpieces.

The amount of light emission is automatically adjusted according to the sensing object. Detection is stable and accurate regardless of the color.

POINT

## Physical value display

Unlike relative value displays, the display is intuitive and easy to understand!

The name plate shows the mm in unit.



POINT

## A Good Design Award winner



**GOOD DESIGN AWARD  
2014 award winner**

The sensor won the 2014 Good Design Award not just for its physical design but also for its functional design.

POINT

## Lineup of simple mounting brackets

Material SUS304. Possible to fine-adjust the detection direction!  
Model: MS-HG-01

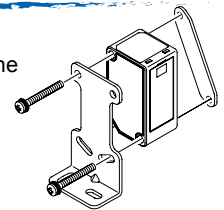

## Type and price

Type	Appearance	Measurement center distance and measuring range	Repeatability	Beam diameter	Model No.
Measurement center 30 mm 1.181 in type		30 mm $\pm 5$ mm 1.181 in $\pm 0.196$ in	10 µm 0.394 mil	Approx. $\phi 50$ µm 1.969 mil	HG-C1030(-P)
Measurement center 50 mm 1.969 in type		50 mm $\pm 15$ mm 1.969 in $\pm 0.590$ in	30 µm 1.181 mil	Approx. $\phi 70$ µm 2.756 mil	HG-C1050(-P)
Measurement center 100 mm 3.937 in type		100 mm $\pm 35$ mm 3.937 in $\pm 1.377$ in	70 µm 2.756 mil	Approx. $\phi 120$ µm 4.724 mil	HG-C1100(-P)

# Rich functions condensed in a compact body!

## Zero-set function

A function for forcing the measured value to zero. This enables the zero point to be set to any value. This is useful when measuring tolerances in reference to the height of the sensing object or when measuring height differences.

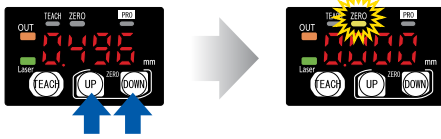

Hold down simultaneously for 3 seconds

## External input setting function

"Zero-set function," "teaching function," "emission halt function," or "trigger function" can be assigned to the external input line.

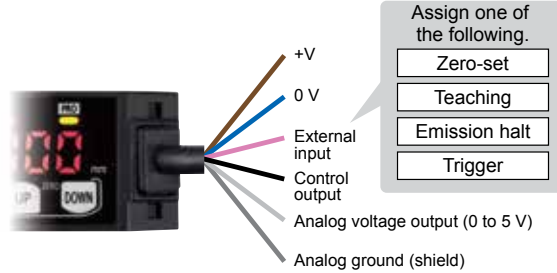

## Peak hold or bottom hold function

Peak hold or bottom hold function is available. The peak hold function, when enabled, holds the maximum measured value for displaying and output. And the bottom hold function, when enabled, holds the minimum measured value for displaying and output.

## Timer setting function

The timer operation can be set to "off delay timer," "on delay timer," "one shot timer," or "no timer." The timer period is fixed at 5 ms.

## Teaching and window comparator mode

Simply press the "TEACH" key when the sensing object is in a certain state to set threshold values. Also, a single output can be used to indicate values within a range bounded by two threshold values to be OK and values that are not to be NG.

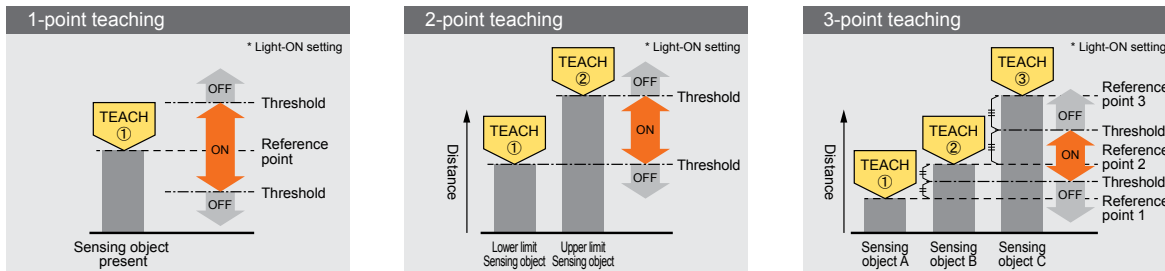

## Display setting function

The display mode for the traveling direction of the sensing object can be set to Standard, Inverted, or Offset.

Example: HG-C1050	Near measurement point	Measurement center	Far measurement point
Standard	56.8 mm	0.00 mm	-15.00 mm
Inverted	14.2 mm	0.00 mm	15.00 mm
Offset	0.56 mm	15.00 mm	0.00 mm

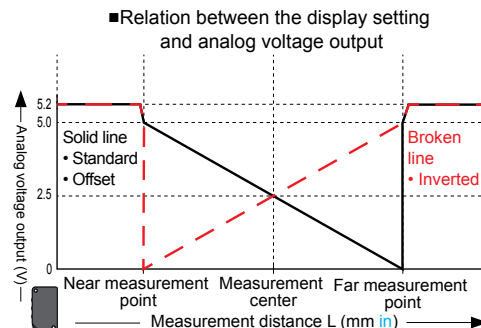



### Determining front/back of cast parts

HG-C1100

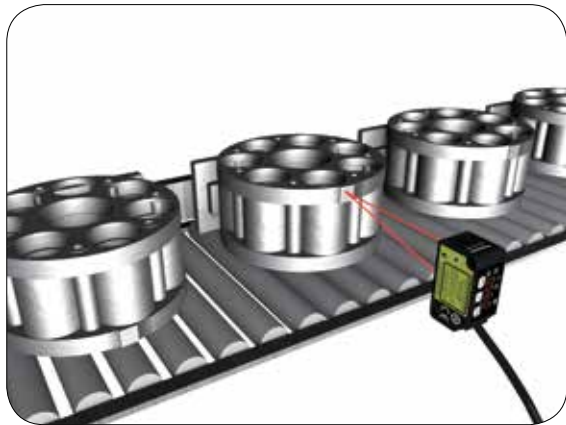

#### Conventional method

Using a convergent reflective sensor, detect the 3 mm 0.118 in height difference on the side of the cast part to determine the front or back.

#### Problems with conventional method

- The detection is unstable depending on the surface condition of the workpiece.
- Only front/back determination is possible. Expensive laser displacement sensors cannot be used.

#### Benefits

- Reliably detects the 3 mm 0.118 in height difference without being affected by the surface condition of the workpiece.
- Implementation was possible at a lower cost compared to the conventional laser displacement sensor.
- Configuration is easy with 2-point teaching.

### Measuring tire wheel strain

HG-C1100

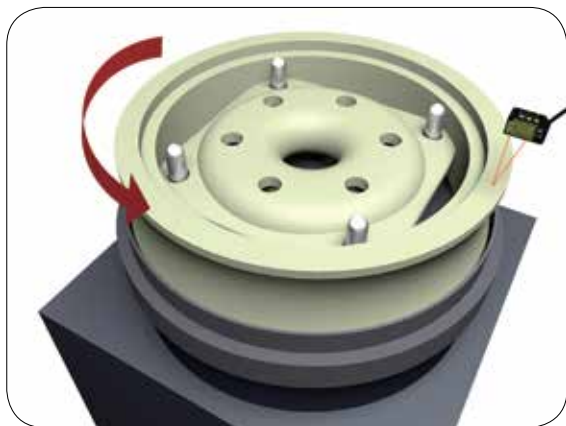

#### Conventional method

Measure the tractor tire wheel distortion using a dial indicator.

#### Problems with conventional method

- It takes a long time because there are many measurement points.
- The indicator is difficult to read, and errors occur depending on who is reading it.

#### Benefits

- The whole circumference can be measured without contact at high precision.
- The numerical display of actual measurements makes it easy to read, and analog output can be used to manage data.
- Zero-set is easy using external input.

### Detecting notches in automotive components

HG-C1100

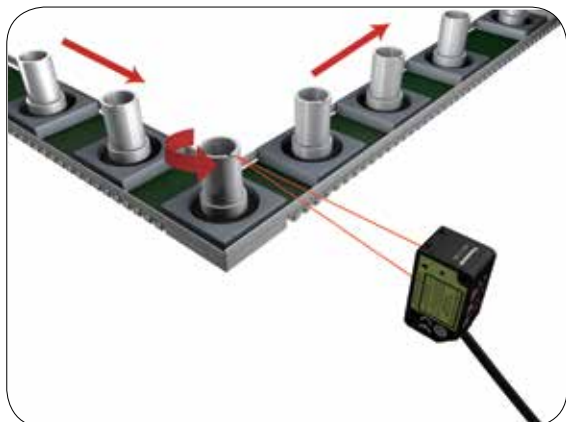

#### Conventional method

Rotate the metallic part, detect the notch at the top section with a convergent reflective sensor, position it, and then re-transport.

#### Problems with conventional method

- The detection is unstable using a convergent reflective sensor depending on the surface condition of the workpiece.
- Because the spot is large, resetting after maintenance takes a long time.

#### Benefits

- Reliably detects the presence/absence of notches using  $\phi 120 \mu\text{m}$  4.724 mil minute spotting.
- It is not affected by the gloss or uneven coloring of the surface.
- The bright laser spot makes it easy to reset after maintenance.





## Shaft placement in the rotation direction

HG-C1100



### Conventional method

Rotate the shaft and detect the vertical groove (2 mm 0.079 in) using a LED type spot-beam sensor for placement.

### Problems with conventional method

- Because the LED spot is large, it is affected by shapes other than the groove, which leads to operation errors.

### Benefits

- The groove is detected by a minute laser spot, so it is unaffected by complicated shapes.
- Even when the workpiece diameter changes, teaching is possible through external input.

## Determining the inner diameter of metallic parts

HG-C1050

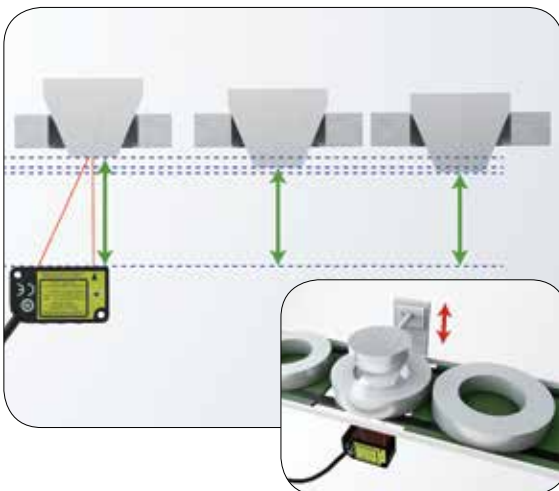

### Conventional method

Image data processing was used to distinguish workpieces whose outer diameter is the same but the inner diameter is different.

### Problems with conventional method

- Image data processing setup is difficult, and only some people can use it.
- Image data processing is expensive.

### Benefits

- Inner diameter can be distinguished by the difference in the distance to the attachment.
- Installation and determination can be performed at a lower cost and more easily than image data processing.

## Detecting the distance between a robot hand and steel plate

HG-C1100

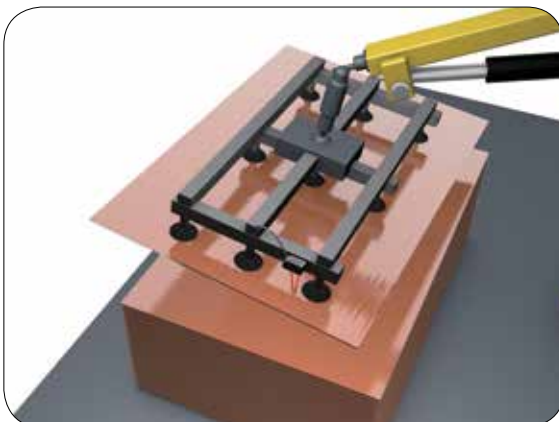

### Conventional method

Measure the distance between the steel plate and transfer robot using an amplifier-separated CMOS laser sensor.

### Problems with conventional method

- The head is large and makes installation and adjustment difficult.
- Securing space for the amplifier is difficult.

### Benefits

- Installation is easy because the sensor is compact and the amplifier is built in.
- Being light (only about 85 g), it can be safely attached to the moving robot arm.
- Since the physical distance is displayed, it is easy to adjust the distance between the steel and suction pad.

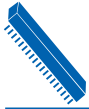

## Determining the button height of electric components

HG-C1050



### Conventional method

Detect whether the height of push buttons is in the upper limit or lower limit range using two sensors.

### Problems with conventional method

- Adjusting the two sensors separately takes a long time.
- Two PLC input ports are necessary.

### Benefits

- The comparator function makes determination possible using a single sensor. The time needed for adjustment is shortened.
- Only a single PLC input port is necessary, which reduces cost.
- Obviously, this means that only a single sensor is necessary, and this also reduces cost.

## Detecting bulges on bonded metallic parts

HG-C1030

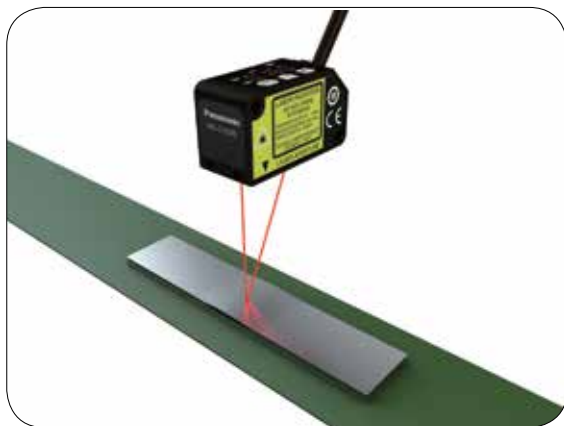

### Conventional method

Detect 0.2 mm **0.008 in** bulges using CMOS laser analog sensors for measurement.

### Problems with conventional method

- An expensive measurement sensor is used to detect 0.2 mm **0.008 in** bulges.
- No problems in accuracy but comes at a high cost.

### Benefits

- Accurately detects 0.2 mm **0.008 in** bulges even at a low cost.
- Thanks to its compactness and built-in amplifier, a separate amplifier is not necessary, and installation is easy.
- The sensor is simpler and easier to handle than measurement sensors.

## Determining front/back of electronic component covers

HG-C1030



### Conventional method

Detect the difference between the front and back dimensions of 0.1 mm **0.003 in** from the bottom using a fiber sensor.

### Problems with conventional method

- Stains on the fiber end cause operation errors.

### Benefits

- Accurately detects the height difference of 0.1 mm **0.003 in** from above.
- The minute spot of approximately  $\varnothing 50 \mu\text{m}$  makes it easy to adjust.
- The sensor is hardly affected by the surface condition of the workpiece.

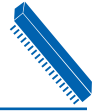

## Detecting smartphone cover seals

HG-C1030

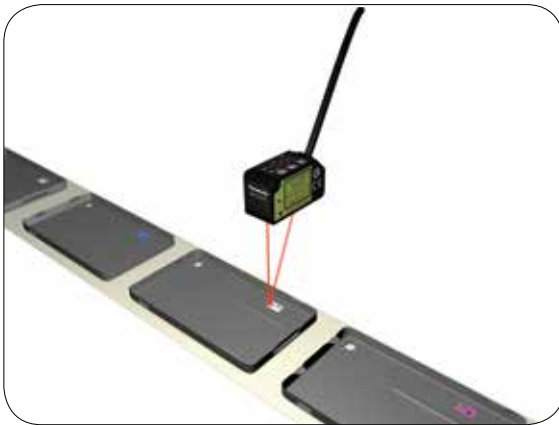

### Conventional method

An integrated image data processing system is used to detect the presence or absence of differently colored seals.

### Problems with conventional method

- An integrated image data processing system is used to support different colors. This makes the system expensive.
- Installation and adjustment of the integrated image data processing system are difficult.

### Benefits

- Accurately detects the presence or absence of 0.2 mm 0.008 in seals.
- Since the height difference is detected, there is no effect even if the seal color changes.

## Detecting overlap of shim washers

HG-C1030



### Conventional method

Measure the thickness using a contact sensor to detect overlap.

### Problems with conventional method

- Unable to change to a non-contact sensor because the laser displacement sensor is too expensive.

### Benefits

- Stable detection of overlapping even for thin shim washers.
- Significantly less expensive than the conventional laser displacement sensor.
- The use of a non-contact sensor eliminates worries about damaging the workpiece and improves takt time.

## Detecting presentation box floating lid

HG-C1100

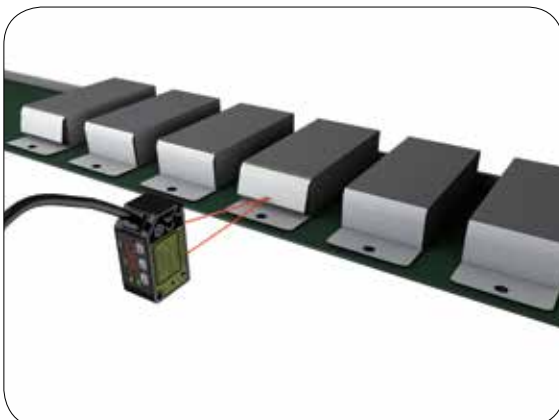

### Conventional method

Detect the floating box lid using a convergent reflective sensor.

### Problems with conventional method

- The spot is large and cannot detect subtle floating.
- Unable to spend so much as to purchase an expensive laser displacement sensor.

### Benefits

- Reliably detects subtle floating lids.
- Stable detection is possible even if the box color changes.
- Can be implemented at a cost close to a general-purpose sensor.





## Detecting cap of cosmetic containers

HG-C1100

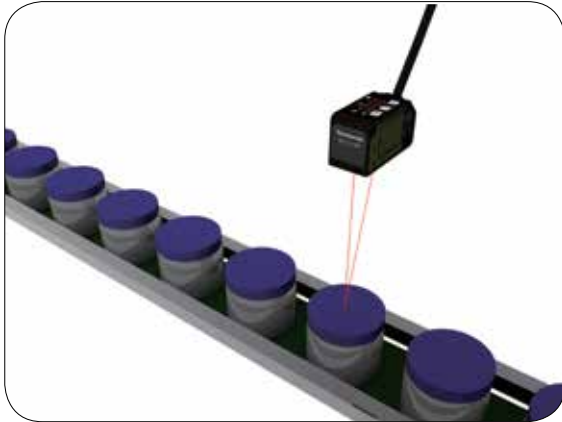

### Conventional method

Detect the presence or absence of caps using a general-purpose distance measurement sensor.

### Problems with conventional method

- Detection using conventional distance measurement sensors is unstable depending on the workpiece color or gloss.

### Benefits

- Stable detection is possible regardless of the workpiece color or gloss.
- The bright laser spot beam makes it easy to install and maintain.
- Configuration is extremely easy. Simply press the teaching button.

## Determining the presence or absence of hot melt

HG-C1100

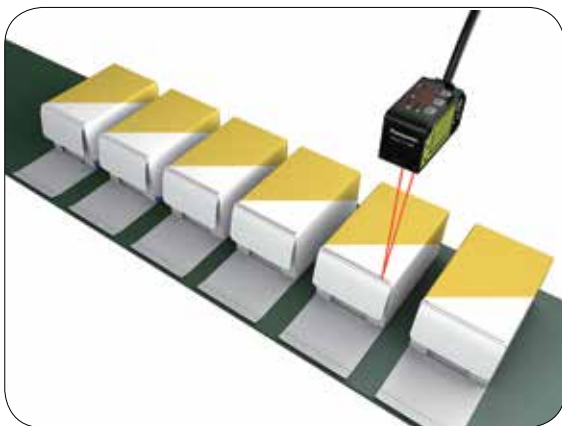

### Conventional method

Determine the presence or absence of hot melt using a gloss sensor.

### Problems with conventional method

- Detection becomes unstable depending on the background gloss or the like.

### Benefits

- Since the height of hot melt is detected, it is not affected by the background color.
- Compact. The built-in amplifier eliminates the need to install a separate amplifier.
- Display and control are possible directly from the sensor. This makes it possible to adjust while checking the actual workpiece.

## Determining front/back of food packaging caps

HG-C1100

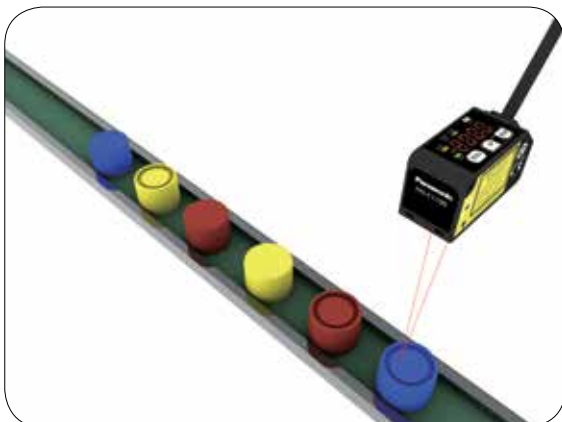

### Conventional method

Determine the difference between the cap's front and back dimensions of 2 mm **0.079 in** from a sensing range of 100 mm **3.937 in** using a distance measurement sensor.

### Problems with conventional method

- Detection using conventional distance measurement sensors is unstable depending on the workpiece color or gloss.

### Benefits

- Stably detects a height difference of 2 mm **0.079 in** from a sensing range of 100 mm **3.937 in**.
- Detection is not affected by the color or gloss of workpieces.
- Less expensive than laser displacement sensors for measurement.





## Detecting the passing of cookies

HG-C1100

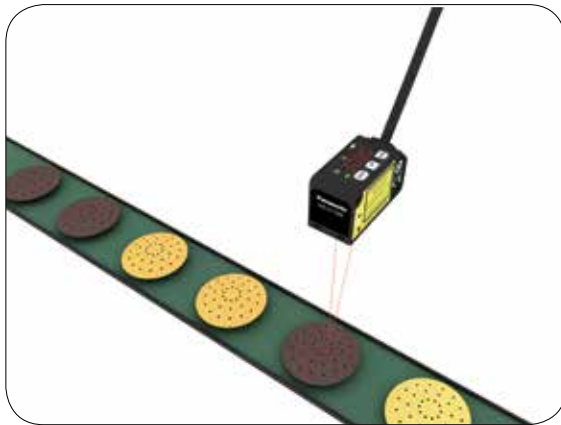

### Conventional method

Detect the passing of cookies using an amplifier-separated CMOS laser sensor.

### Problems with conventional method

- Detection is unstable depending on the surface conditions such as flavoring, toppings, and doneness.
- Detection is also unstable depending on the conveyor color.

### Benefits

- Detect all sorts of cookies without being affected by the conveyor color.
- Reduced cost as compared to conventional sensors.
- The built-in amplifier makes it possible to check the display while installing the sensor.

## Detecting floating of spray can caps

HG-C1100

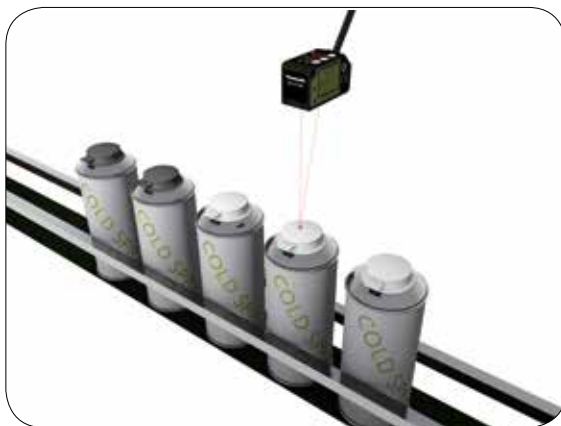

### Conventional method

Detect floating spray can caps using an amplifier-separated CMOS laser sensor.

### Problems with conventional method

- An expensive sensor is necessary to detect floating caps at 0.5 mm 0.019 in resolution.
- The sensor is large, and a separate amplifier must be installed.

### Benefits

- Accurately detects floating caps even if the cap color changes.
- Reduced cost as compared to conventional sensors.
- The built-in amplifier makes installation and configuration easy.

## Detecting thin gum boxes

HG-C1100

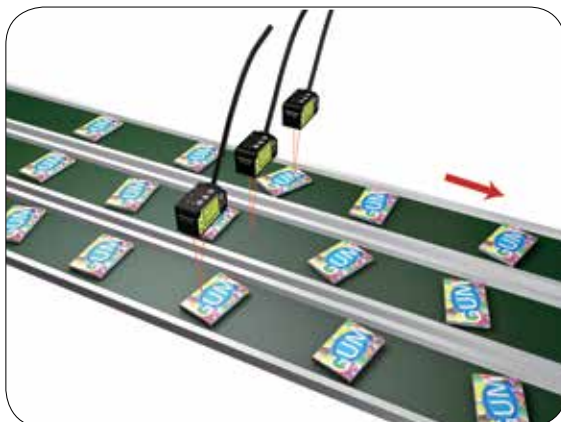

### Conventional method

Detect the passing of gum boxes using an amplifier-separated CMOS laser sensor.

### Problems with conventional method

- High cost
- Requires a separately installed amplifier, and configuration is a hassle.

### Benefits

- Since the sensor is compact and has a built-in amplifier, it is possible to install the sensor while checking the display. And, there is no need for a separate amplifier.
- Even though the sensor uses high-precision CMOS laser, the cost is low, similar to the cost of general-purpose sensors.
- The sensor is not easily affected by the color or luster of workpieces. Reliable detection is possible even for colorful presentation boxes.

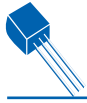

## Detecting seams (overlapping) of functional sheets

HG-C1030

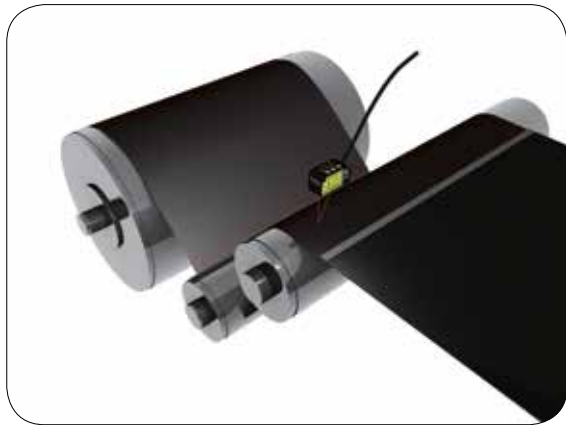

### Conventional method

Detect seams (overlapping) of functional sheets that are 0.15 mm 0.006 in thick using a laser displacement sensor for measurement.

### Problems with conventional method

- Detection is unstable depending on the gloss and other characteristics.

### Benefits

- Accurately detects overlapping of 0.15 mm 0.006 in sheets regardless of the gloss.
- Its compactness and built-in amplifier make installation and configuration easy.
- Less expensive than laser displacement sensors for measurement.

## Detecting glass substrate protection sheets

HG-C1100

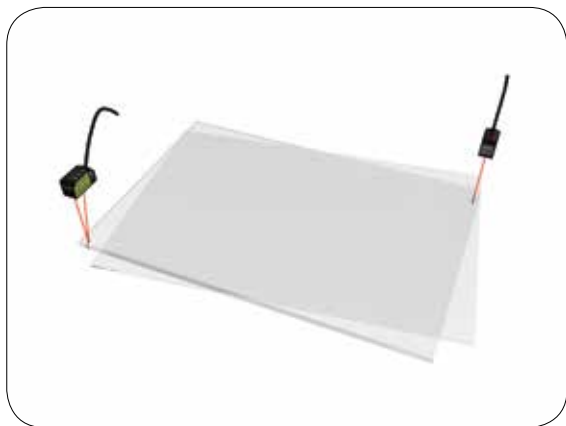

### Conventional method

Detect glass substrate protection sheets using a contact sensor.

### Problems with conventional method

- Since the sensor is a contact type, there is a fear of damaging the workpieces.
- Because the sheet is translucent, conventional optical sensors are unstable.

### Benefits

- Accurately detects the height difference of translucent sheets using a laser beam.
- Since the sensor is a non-contact type, there is no fear of damaging the workpieces.
- Its compactness and built-in amplifier make installation and configuration easy.

## Detecting overlap of two chip components

HG-C1030

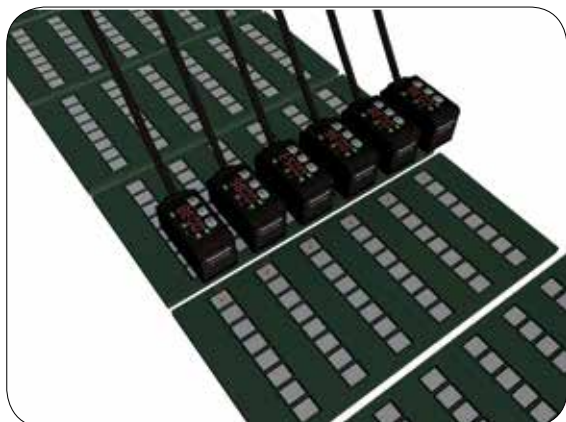

### Conventional method

Detect the overlapping of two chip components that are 60  $\mu\text{m}$  2.362 mil thick using an amplifier-separated CMOS laser sensor.

### Problems with conventional method

- Multiple sensors need to be used, but the cost per sensor is expensive.
- Space for installing an amplifier for each sensor is necessary.

### Benefits

- Significant cost reduction as compared to conventional sensors.
- Its compactness and built-in amplifier make wiring and installation easy.
- Adjustment is easy with 2-point teaching.



## Thickness control of plywood

HG-C1030

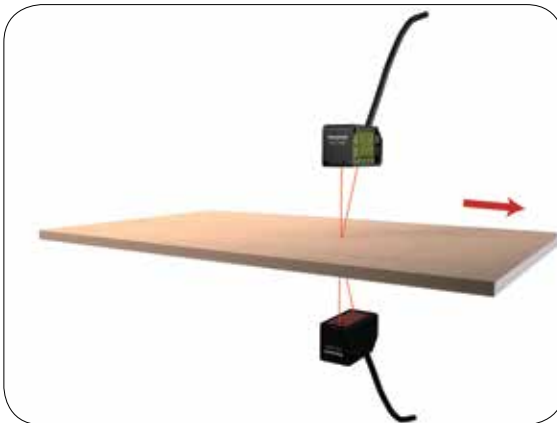

### Conventional method

Using an amplifier-separated CMOS laser sensor, measure the board thickness of the plywood that is pressed out, and feed back the data to the press machine to control the thickness.

### Problems with conventional method

- There is deviation in the data sampling by the two sensors, and measurement errors occur when compared to the actual thickness.
- High cost

### Benefits

- Errors caused by movement are reduced by applying a trigger signal simultaneously to the two sensors and acquiring the held values. This makes it possible to measure the board thickness with high precision.
- Its compactness and built-in amplifier make installation and configuration easy.

## Detecting various kinds of wallpaper

HG-C1030

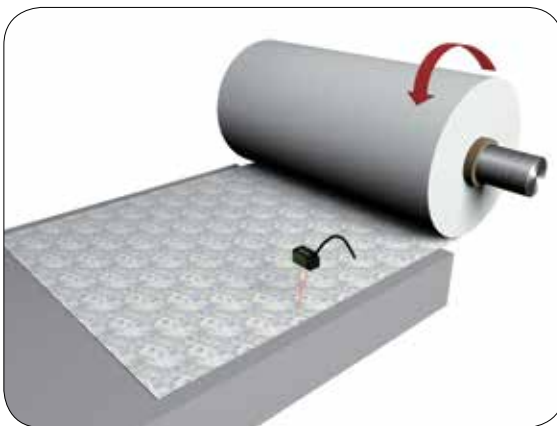

### Conventional method

Detect various kinds of wallpaper using an amplifier-separated CMOS laser sensor.

### Problems with conventional method

- High cost
- Requires a separately installed amplifier, and configuration is a hassle.

### Benefits

- Accurately detects thin wallpaper and wallpaper of different color and material.
- Less expensive than the conventional CMOS laser sensor.
- Because the amplifier is built-in, measurements can be verified and appropriate adjustments can be made at the installation location.

## Detecting IC card warping

HG-C1030

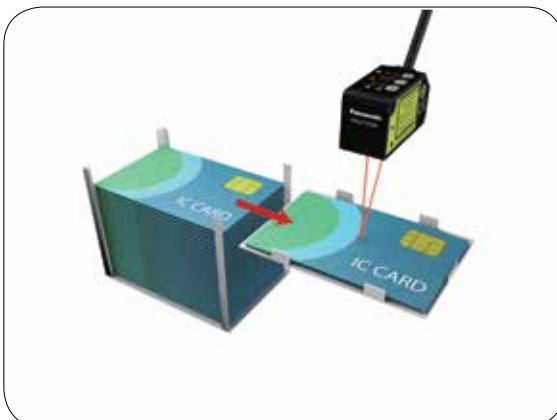

### Conventional method

Detect whether the card warping is within the tolerance using an amplifier-separated CMOS laser sensor.

### Problems with conventional method

- High cost
- Space for installing the separate amplifier must be furnished.

### Benefits

- Upper and lower limits can be set with 1-point teaching, making it simple and easy to use.
- Implementation is possible at a lower cost compared to the conventional laser displacement sensor.
- The built-in amplifier makes installation easy and keeps equipment more compact.

HG-C SERIES

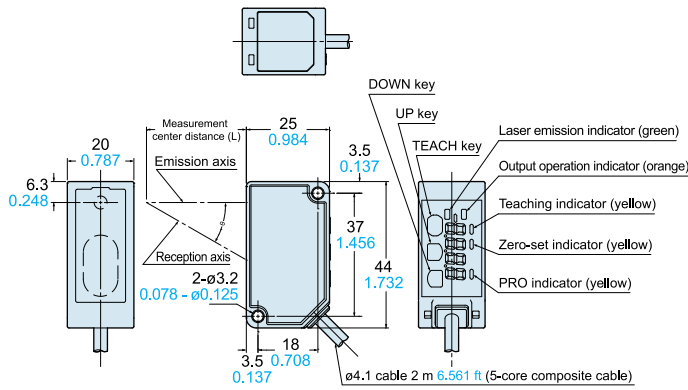

MS-HG-01  
Mounting diagram

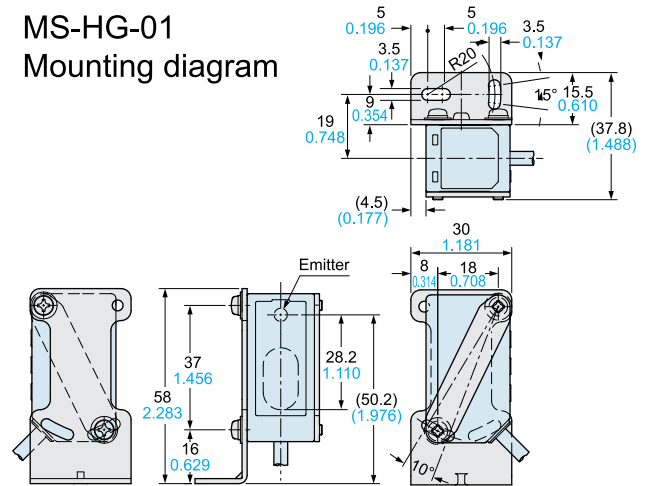

North America

Europe

Asia Pacific

China

Japan

Panasonic Electric Works

Please contact our Global Sales Companies in:

Europe

▶ <b>Headquarters</b>	<b>Panasonic Electric Works Europe AG</b>	Robert-Koch-Straße 100, 85521 Ottobrunn, Tel. +49 89 45354-1000, Fax +49 89 45354-2111, www.panasonic-electric-works.com
▶ <b>Austria</b>	<b>Panasonic Electric Works Austria GmbH</b>	Josef Madersperger Str. 2, 2362 Biedermannsdorf, Tel. +43 (0) 2236-26846, Fax +43 (0) 2236-46133 www.panasonic-electric-works.at
	<b>Panasonic Industrial Devices Materials Europe GmbH</b>	Ennschafenstrasse 30, 4470 Enns, Tel. +43 (0) 7223 883, Fax +43 (0) 7223 88333, www.panasonic-electronic-materials.com
▶ <b>Benelux</b>	<b>Panasonic Electric Works Sales Western Europe B.V.</b>	De Rijn 4, (Postbus 211), 5684 PJ Best, (5680 AE Best), Netherlands, Tel. +31 (0) 499 372727, Fax +31 (0) 499 372185, www.panasonic-electric-works.nl
▶ <b>Czech Republic</b>	<b>Panasonic Electric Works Europe AG, organizační složka</b>	Administrative centre PLATINIUM, Veverí 3163/111, 616 00 Brno, Tel. +420 541 217 001, Fax +420 541 217 101, www.panasonic-electric-works.cz
▶ <b>France</b>	<b>Panasonic Electric Works Sales Western Europe B.V.</b>	Succursale française, 10, rue des petits ruisseaux, 91370 Verrières Le Buisson, Tél. +33 (0) 1 6013 5757, Fax +33 (0) 1 6013 5758, www.panasonic-electric-works.fr
▶ <b>Germany</b>	<b>Panasonic Electric Works Europe AG</b>	Robert-Koch-Straße 100, 85521 Ottobrunn, Tel. +49 (0) Tel. +49 (0) 45354-1000, Fax +49 (0) 45354-2111, www.panasonic-electric-works.de
▶ <b>Hungary</b>	<b>Panasonic Electric Works Europe AG</b>	Magyarországi Közvetlen Kereskedelmi Képviselet, 1117 Budapest, Neumann János u. 1., Tel. +43 2236 26846-25, Mobile: +36 20 264 9896, Fax +43 2236 46133, www.panasonic-electric-works.hu
▶ <b>Ireland</b>	<b>Panasonic Electric Works UK Ltd.</b>	Irish Branch Office, Dublin, Tel. +353 (0) 14600969, Fax +353 (0) 14601131, www.panasonic-electric-works.co.uk
▶ <b>Italy</b>	<b>Panasonic Electric Works Italia srl</b>	Via del Commercio 3-5 (Z.I. Ferlina), 37012 Bussolengo (VR), Tel. +39 0456752711, Fax +39 0456700444, www.panasonic-electric-works.it
▶ <b>Nordic Countries</b>	<b>Panasonic Electric Works Europe AG Panasonic Eco Solutions Nordic AB</b>	Filial Nordic, Knarrarnäsgatan 15, 164 40 Kista, Sweden, Tel. +46 859476680, Fax +46 859476690, www.panasonic-electric-works.se
▶ <b>Poland</b>	<b>Panasonic Electric Works Polska sp. z o.o</b>	Jungmansgatan 12, 21119 Malmö, Tel. +46 40 697 7000, Fax +46 40 697 7099, www.panasonic-fire-security.com
▶ <b>Spain</b>	<b>Panasonic Electric Works España S.A.</b>	ul. Wołoska 9A, 02-583 Warszawa, Tel. +48 22 338-11-33, Fax +48 22 338-12-00, www.panasonic-electric-works.pl
▶ <b>Switzerland</b>	<b>Panasonic Electric Works Schweiz AG</b>	Barajas Park, San Severo 20, 28042 Madrid, Tel. +34 913293875, Fax +34 913292976, www.panasonic-electric-works.es
▶ <b>United Kingdom</b>	<b>Panasonic Electric Works UK Ltd.</b>	Grundstrasse 8, 6343 Rotkreuz, Tel. +41 (0) 41 7997050, Fax +41 (0) 41 7997055, www.panasonic-electric-works.ch
		Sunrise Parkway, Linford Wood, Milton Keynes, MK14 6LF, Tel. +44 (0) 1908 231555, Fax +44 (0) 1908 231599, www.panasonic-electric-works.co.uk

North & South America

▶ <b>USA</b>	<b>Panasonic Industrial Devices Sales Company of America</b>	629 Central Avenue, New Providence, N.J. 07974, Tel. 1-908-464-3550, Fax 1-908-464-8513, www.pewa.panasonic.com
--------------	--	---

Asia Pacific/China/Japan

▶ <b>China</b>	<b>Panasonic Electric Works Sales (China) Co. Ltd.</b>	Level 2, Tower W3, The Towers Oriental Plaza, No. 2, East Chang An Ave., Dong Cheng District, Beijing 100738, Tel. +86-10-5925-5988, Fax +86-10-5925-5973
▶ <b>Hong Kong</b>	<b>Panasonic Industrial Devices Automation Controls Sales (Hong Kong) Co., Ltd.</b>	RM1205-9, 12/F, Tower 2, The Gateway, 25 Canton Road, Tsimshatsui, Kowloon, Hong Kong, Tel. +852-2956-3118, Fax +852-2956-0398
▶ <b>Japan</b>	<b>Panasonic Corporation</b>	1048 Kadoma, Kadoma-shi, Osaka 571-8686, Japan, Tel. +81-6-6908-1050, Fax +81-6-6908-5781, www.panasonic.net
▶ <b>Singapore</b>	<b>Panasonic Industrial Devices Automation Controls Sales Asia Pacific</b>	300 Beach Road, #16-01 The Concourse, Singapore 199555, Tel. +65-6390-3811, Fax +65-6390-3810

