



Safety Control Unit

SF-C21

Instruction Manual



(MEMO)

Thank you for purchasing Panasonic Industry's Safety Control Unit **SF-C21**.

Please read this instruction manual carefully and thoroughly for the correct and optimum use of this device.

Kindly keep this manual in a convenient place for quick reference.

This device is a safety control unit for machines.

This manual is for the personnel who have undergone suitable training, have knowledge of safety of machines and knowledge of electricity (are electric workers or have knowledge equivalent to that of the workers), and

- who are responsible for the introduction of this device,
- who design the system using this device,
- who install and connect this device,
- who manage and operate a plant using this device, and
- who are qualified and responsible for each of the phases of design, manufacture, installation, operation, maintenance or disposal.

Please fully understand "Safety Standards" introduced in this instruction manual and properly handle the equipment with paying attention to the safety.

Notes

- 1) The contents of this instruction manual may be changed without prior notice for further improvement of the device.
- 2) Though we have carefully drawn up the contents of this instruction manual, if there are any aspects that are not clear, or any error that you may notice, please contact our local Panasonic Industry office of the nearest distributor.
- 3) English and Japanese are original instructions.
- 4) Windows is a registered trademark of U.S. Microsoft Corporation and other countries.
- 5) All other companies and product names are trademarks or registered trademarks of their respective companies.



CONTENTS

Chapter 1 Introduction	7
1-1 Attention Marks	7
1-2 Safety Precautions	7
1-3 Applicable Standards / Regulations	9
1-4 Confirmation of Packed Contents	9
Chapter 2 Before Using This Device	10
2-1 Features	10
2-2 Part Description	12
2-3 Terminal Arrangement	13
2-4 Confirming Product Information	14
2-4-1 Version-related Information	14
2-5 Mounting	15
2-5-1 Installing Direction	15
2-5-2 Installation Space	16
2-5-3 Installation to and Removal from a DIN Rail	18
2-5-4 Installing the Unit Directly in a Control Panel Using Screws	19
2-5-5 Installation Environment	19
2-6 Wiring	20
2-6-1 Power Supply Unit	20
2-6-2 I/O Circuit Diagrams	21
2-6-3 Connecting to the Terminal Block	23
2-6-4 Connection of Safety Devices	24
Chapter 3 Functions	25
3-1 Safety Input	25
3-1-1 Contact Input Mismatch Allowable Time	25
3-2 Control Output	26
3-2-1 Response Time	26
3-3 Auxiliary Output	26
3-4 Interlock (Reset)	27
3-4-1 Overall Reset	27
3-4-2 Partial Reset	28
3-5 Releasing Lockout	29
3-6 External Device Monitor	30
3-7 Test Input	30
3-8 MODBUS Communication (Non-safety)	31
3-8-1 MODBUS RTU Specification	31
3-8-2 Wiring Example	32
3-8-3 Function Code	33
3-8-4 Error Codes	33
3-8-5 Address Map	34
3-8-6 Message Format	35
3-8-7 Function Code	36
3-9 USB Communication	38
3-10 Logic Selection Function	39
3-11 OFF Delay Time Selection Function	47

3-12	Logic Settings by Software Tool	48
3-13	Logic Manual Stop / Start Function	49
Chapter 4	Setting of Logics	50
4-1	Types and Settings of Logics	50
4-1-1	Factory Setting	50
4-2	Preparation for Logic Setting	51
4-2-1	Turning ON the Power	51
4-2-2	Portions Used in Settings	51
4-3	Operation in RUN Mode and the Display	52
4-3-1	Operation and Display During Normal Operation	52
4-3-2	Display When an Error Occurs	53
4-4	Setting of Logics and OFF Delay Time	54
4-4-1	Flowchart of Logic and OFF Delay Time	54
4-4-2	Operation Procedure for Setting Logic and OFF Delay Time	55
4-5	Change Password	61
4-5-1	Flowchart of Change Password	61
4-5-2	Operation Procedure for Change Password	62
Chapter 5	Software Tool	67
5-1	System Configuration	67
5-2	System requirements	68
5-3	Installation	68
5-4	Uninstallation	68
5-5	Connection of this Device and a PC	69
5-5-1	Connection to "Monitor Mode"	69
5-5-2	Connection to "Transfer Mode"	70
5-5-3	Setting to "Monitor Mode" after the End of Transfer	71
5-5-4	Disconnection of this Device from a PC	71
5-5-5	Initialization of this Device	71
5-6	Startup and End of Software Tool	72
5-6-1	Startup Software Tool	72
5-6-2	End of Software Tool	74
5-7	New / Save / Print of a File	75
5-7-1	Create New File	75
5-7-2	Open Sample Logic	77
5-7-3	Open a Recent File	79
5-7-4	Upload Logic from this Device	81
5-7-5	Saving a File	82
5-7-6	Download Logic to Device	84
5-7-7	Print	86
5-8	Each Part Name of the Software Tool and Basic Operation	87
5-9	Creating and Editing a Logic, and Saving a File and Transferring it to this Device	89
5-9-1	Creating and Editing Logic	89
5-9-2	Saving a Logic File and Transferring it to this Device	89
5-10	Create a Logic	90
5-10-1	Create a Logic	90
5-10-1-1	Set Input Lock	90
5-10-1-2	Set Control Block 1	91

5-10-1-3 Create a Circuit	91
5-10-2 Example of a Logic Using Control Block 1 / 2	93
5-10-3 Example of a Logic Using Control Block 1 / 2 / 3	94
5-11 Select Input	95
5-11-1 Types of Inputs	95
5-11-2 Setting of Contact Input Mismatch Allowable Time	96
5-11-3 Input Filter Time Setting	97
5-12 Select Control	98
5-13 Interlock block	100
5-14 Auxiliary Output Block	101
5-15 Mode switching block	102
5-15-1 Mode Switching	102
5-15-2 Simulation Mode	102
5-16 Output Setting, OFF Delay and ON Delay Setting	104
5-17 Detailed Settings (Muting)	104
5-18 Logic Display Edit	105
5-19 Verify Files on the Device and PC	105
5-20 Configuration Check	106
5-21 Highlighting OFF	107
5-22 Device Information	107
5-22-1 General	107
5-22-1-1 Change Password	107
5-22-1-2 Initialize Settings	108
5-22-1-3 Initialize Password	108
5-22-2 Configuration Log	109
5-22-3 Error Log	109
5-23 Communication Settings	110
5-24 Monitor	111
5-25 Help	112
5-25-1 Language	112
5-25-2 Manual	112
5-25-3 Version Information	112
 Chapter 6 Maintenance	 113
6-1 Daily Inspection	113
6-2 Periodic Inspection (Every Six Months)	113
6-3 Inspection after Maintenance of this Device	114
 Chapter 7 Troubleshooting	 115
 Chapter 8 Specifications / Dimensions	 117
8-1 Specifications	117
8-2 Dimensions	119
 Chapter 9 Others	 120
9-1 Glossary	120
9-2 CE Marking Declaration of Conformity	121
9-3 UKCA Marking Declaration of Conformity	122

1-1 Attention Marks

This instruction manual employs the following attentions marks “ **WARNING**,” “ **CAUTION**” depending on the degree of the danger to call operator’s attention to each particular action. Read the following explanation of these marks thoroughly and observe these notices without fail.

 **WARNING** If you ignore the advice with this mark, death or serious injury could result.

 **CAUTION** If you ignore the advice with this mark, injury or material damage could result.

<Reference> It gives useful information for better use of this device.

Note that items described in “ **CAUTION**” may lead to serious results, depending on situations.

Be sure to observe these important items described.

1-2 Safety Precautions

- Use this device as per its specifications. Do not modify this device since its functions and capabilities may not be maintained and it may malfunction.
- This device has been developed / produced for industrial use only.
- Use of this device under the following conditions or environments is not presupposed. Please consult us if there is no other choice but to use this device in such an environment.
 - 1) Operating this device under conditions or environments not described in this manual.
 - 2) Using this device in the following fields: nuclear power control, railroad, aircraft, auto mobiles, combustion facilities, medical systems, aerospace development, etc.
- In case of installing this device to a particular machine, follow the safety regulations in regard to appropriate usage, mounting (installation), operation and maintenance. The users including the installation operator are responsible for the introduction of this device.
- Note that this device may be damaged if it is subject to a strong shock (if it is dropped onto the floor, for example).
- Use this device by installing suitable protection equipment as a countermeasure for failure, damage, or malfunction of this device.
- Before using this device, check whether the device performs properly with the functions and capabilities as per the design specifications.
- In case of disposal, dispose this device as an industrial waste.

WARNING

◆ **Machine designer, installer, employer and operator**

- The machine designer, installer, employer and operator are solely responsible to ensure that all applicable legal requirements relating to the installation and the use in any application are satisfied and all instructions for installation and maintenance contained in the instruction manual are followed.
- Whether this device functions as intended to and systems including this device comply with safety regulations depends on the appropriateness of the application, installation, maintenance and operation. The machine designer, installer, employer and operator are solely responsible for these items.

◆ **Engineer**

- The engineer would be a person who is appropriately educated, has widespread knowledge and experience, and can solve various problems which may arise during work, such as a machine designer, or a person in charge of installation or operation etc.

◆ **Operator**

- The operator should read this instruction manual thoroughly, understand its contents, and perform operations following the procedures described in this manual for the correct operation of this device.
- In case this device does not perform properly, the operator should report this to the person in charge and stop the machine operation immediately. The machine must not be operated until correct performance of this device has been confirmed.

◆ **Environment**

- Do not use a mobile phone or a radio phone near this device.
- This device starts the performance after 2 seconds from the power ON. Have the control system started to function with this timing.
- Do not install this device in the following environments.
 - 1) The device is exposed to direct sunlight
 - 2) Dew condensation may occur due to sudden changes in temperature
 - 3) The ambient air contains corrosive or flammable gas
 - 4) There is a high level of dust, metallic dust, or salt content
 - 5) The device may be exposed to organic solvents such as benzene, thinner, or alcohol and/or strong alkaline substances such as ammonia or caustic soda, or any such substances exist in the ambient air
 - 6) The device may be directly exposed to vibration or impact or to water drops
 - 7) The device may be exposed to interference from nearby high-voltage lines, high-voltage equipment, power wires, motor equipment, an amateur radio station or other transmitter, or a device with large switching surges (the device must be placed at a distance of 100mm or greater from any interference sources)

◆ **Wiring**

- Do not work on (connect or remove etc.) the device while the power is ON. Failure to follow this precaution could result in an electric shock.
- All electrical wiring should conform to the regional electrical regulations and laws. The wiring should be done by engineer(s) having the special electrical knowledge
- Do not run the wires together with high-voltage lines or power lines or put them in the same raceway. This can cause malfunction due to induction.
- Do not control the device only at one control output.

◆ **Maintenance**

- When replacement parts are required, always use only genuine supplied replacement parts. Do not use a third-party part because doing so could cause the device to malfunction, possibly resulting in a death or serious injury.
- The periodical inspection of this device must be performed by an engineer having the special knowledge.
- After maintenance or adjustment, and before starting operation, test this device following the procedure specified in "**Chapter 6 Maintenance.**"
- Clean this device with a clean cloth. Do not use any volatile chemicals.

◆ **Others**

- Never modify this device. Failure to follow this precaution may cause the device to malfunction, possibly resulting in a death or serious injury.

1-3 Applicable Standards / Regulations

This device complies with the following standards / regulations.

<EU Directives>

EU Directive : Machinery Directive 2006/42/EC
EMC Directive 2014/30/EU
RoHS Directive 2011/65/EU

British Legislation : Machinery Legislation 2008/1597
EMC Legislation 2016/1091
RoHS Legislation 2012/3032

- Applicable Standards

EN 55011, EN 61000-6-2, EN 62061 (SILCL3), EN IEC 63000
EN ISO 13849-1: 2015 (Up to category 4, PLe)

Korean Regulation

KS C 9811(EN55011), KS C 9610-6-2(EN 61000-6-2)

<Conforming Standards>

US/Canada Standards : UL 61010-1, CAN/CSA C22.2 No.61010-1
UL 61010-2-201, CAN/CSA C22.2 No.61010-2-201, UL 1998

Other Standards : IEC 61131-2, IEC 61010-2-201, ISO 13849-1 : 2015(Category 4, PLe),
IEC 61508-1~3(SIL3), IEC 62061(SILCL3)
JIS B 3502, JIS B 9705-1(Category 4, PLe), JIS C 0508(SIL3)

For Machinery Directive, type certification by a Notified Body TÜV SÜD has been acquired.
For the standards in US / Canada, cTÜVus mark by a Notified Body TÜV SÜD America has been acquired.

Note 1: Please see the separate product specifications for more information about special-order parts.

<Reference>

The conformity to JIS for this device has been evaluated by ourselves.

WARNING

For the safety of the overall system and the conformity to the standards applicable in each region or country in which this device is installed, take actions on the customer's own responsibility.

1-4 Confirmation of Packed Contents

- SF-C21** 1 pc.
- Quick Instruction Manual (Japanese, English, Chinese, Korean) 1 pc. each language

Chapter 2 Before Using This Device

2-1 Features

This device is a safety control unit. This device has eight built-in preset logics that can deal with various safety systems. The logics can also be set (customizable logics). The preset logics and customizable logics have acquired related international standards. Selecting logics and connecting safety devices can construct various safety circuits.

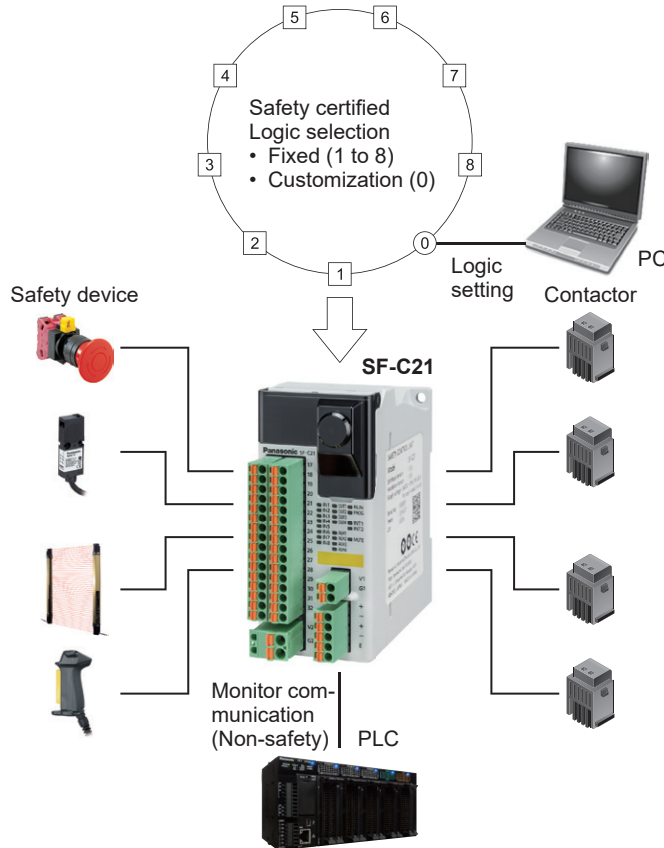

- (1) Selecting preset logics and connecting various safety devices**
This device incorporates eight preset logics supporting basic applications and one customizable logic that can be set freely.
- (2) Easy setting of software tool and customizable logic**
Customizable logics can easily be set in PC by using a software tool.
- (3) Acquisition of safety certification**
This unit is a safety control unit that has acquired IEC 61508 (SIL3) and ISO 13849-1: 2015 (Up to category 4, PLe).
- (4) Safety categories 2, 3, and 4 available**
Selecting logics and connecting various types of safety devices can construct systems available for Categories 2, 3, and 4 of ISO 13849-1: 2015.

(5) Limiting of system space

More system space can be saved compared with a system using safety relay.

(6) Improvement of wiring work efficiency

Adopting a removal terminal block can reduce man-hours for wiring and prevent improper wiring when this device is replaced.

(7) Fail safe function

If a failure occur inside this device, the self-diagnosis function can detect the failure and turn OFF the output.

(8) Enhancement of failure diagnosis

Failures, including those of safety devices in connection is diagnosed by using test pulse (monitoring of cross short fault). In addition, self-diagnosis, e.g., memory diagnosis and circuit diagnosis, is performed.

(9) Installation according to use applications

35mm width DIN rail or M4 round head screw (length: 12mm or more) is available for installation.



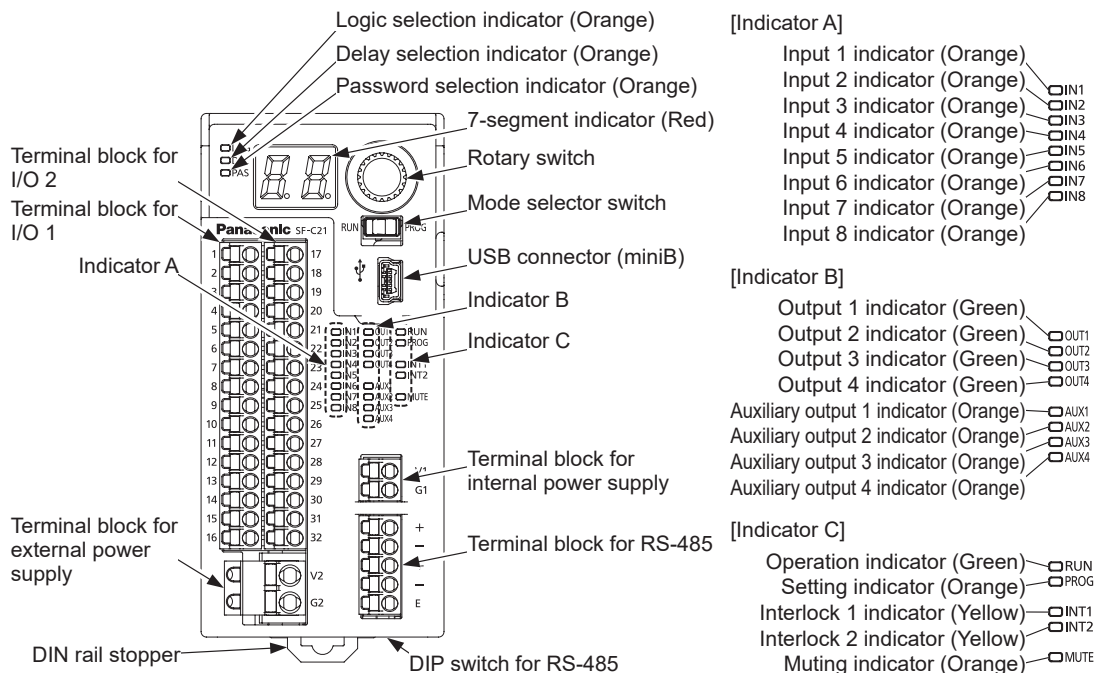

Part Description

2-2 Part Description

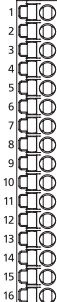

Indicator name	Display	Operation
Logic selection indicator (Orange)	LOG	When logic is selected: lights up in orange Other cases: turn OFF
Delay selection indicator (Orange)	DEL	When OFF delay is selected: lights up in orange Other cases: turn OFF
Password selection indicator (Orange)	PAS	When password is selected: lights up in orange Other cases: turn OFF
7-segment indicator (Red)	-	Selected logic / OFF delay mode is displayed. In lockout state, display of error is displayed.
Input 1 to 8 indicator (Orange)	IN1, IN2, IN3, IN4, IN5, IN6, IN7, IN8	Input at ON state: lights up in orange When input turns OFF: turns OFF
Output 1 to 4 indicator (Green)	OUT1, OUT2, OUT3, OUT4	When output at ON state: lights up in green When output at OFF state: turns OFF
Auxiliary output 1 to 4 indicator (Orange)	AUX1, AUX2, AUX3, AUX4	When output at ON state: lights up in orange When output at OFF state: turns OFF
Operation indicator (Green)	RUN	When normal operation is performed: lights up in green When setting operation: turns OFF
Setting indicator (Orange)	PROG	When setting operation: lights up in orange When normal operation: turns OFF
Interlock 1 / 2 indicator (Yellow)	INT1, INT2	When interlock is effective: lights up in yellow When interlock is ineffective: turns OFF
Muting indicator (Orange)	MUTE	When output at ON state: lights up in orange When output at OFF state: turns OFF

2-3 Terminal Arrangement

	Terminal dimensions	Terminal No.	Terminal name	Function	
Terminal block for I/O 1		1	IN1	Safety input 1	
		2	T1	Safety input 1 / test output	
		3	IN2	Safety input 2	
		4	T2	Safety input 2 / test output	
		5	IN3	Safety input 3	
		6	T3	Safety input 3 / test output	
		7	IN4	Safety input 4	
		8	T4	Safety input 4 / test output	
		9	MUTE1	Muting indicator output 1_1	
		10	NC	Not connected	
		11	INT11	Reset input 1 / test output	
		12	INT12	Reset input 1	
		13	AUX1	Auxiliary output 1	
		14	AUX2	Auxiliary output 2	
		15	AUX3	Auxiliary output 3	
		16	AUX4	Auxiliary output 4	
Terminal block for I/O 2		17	IN5	Safety input 5	
		18	T5	Safety input 5 / test output	
		19	IN6	Safety input 6	
		20	T6	Safety input 6 / test output	
		21	IN7	Safety input 7	
		22	T7	Safety input 7 / test output	
		23	IN8	Safety input 8	
		24	T8	Safety input 8 / test output	
		25	MUTE2	Muting indicator output 1_2	
		26	NC	Not connected	
		27	INT21	Reset input 2 / test output	
		28	INT22	Reset input 2	
		29	OUT1	Control output 1	
		30	OUT2	Control output 1	
		31	OUT3	Control output 2	
		32	OUT4	Control output 2	
Terminal block for internal power supply		-	V1	24V	Power supply for safety input
		-	G1	0V	
Terminal block for RS-485		-	+	Transmission line (+)	
		-	-	Transmission line (-)	
		-	+	Transmission line (+)	
		-	-	Transmission line (-)	
		-	E	Terminal station setting	
Terminal block for external power supply		-	V2	24V	Power supply for control output Power supply for auxiliary output
		-	G2	0V	

When a device (such as light curtain) requiring power supply to inputs is connected, power is supplied from internal power supply. This device does not operate when power is supplied from external power supply.

Confirming Product Information

2-4 Confirming Product Information

The product information on this device can be confirmed on the nameplate on the side of the product.

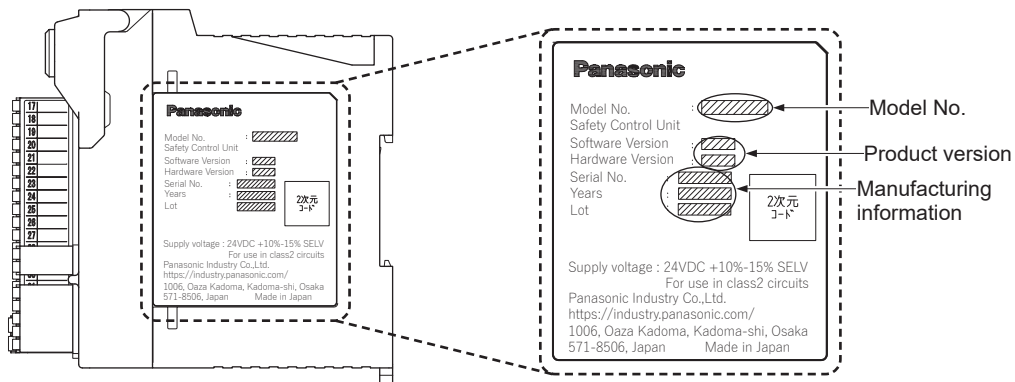

2-4-1 Version-related Information

The versions of **SF-C21** software and software tool "**Configurator SF-C**" have been changed due to addition / change of functions.

The added / changed functions are supported by the versions shown in the table below.

Function	Added / changed	Compatible version		Remarks
		SF-C21 software	Configurator SF-C	
Input filter	Added	Ver. 2.00 and newer	Ver. 2.00 and newer	Settings cannot be made unless the function is supported by both software versions.
Dedicated exit muting	Added			
Sequential muting (Allowable time difference in muting input)	Changed (Note)			
Logic display edit	Added			
Operating System Windows10	Added			
Operating System Windows11	Added			

Note: The setting range has been changed. The setting range in Ver. 1.00 is the same as that for parallel muting.

2-5 Mounting

⚠ WARNING

- Do not touch the terminals while power is turned ON. Doing so may cause an electric shock.
- Be careful to prevent entry of foreign materials, such as chip and wire scrap into this device. Otherwise, this could cause fire, failure or malfunction.
- Do not disassemble or modify this device. Doing so could cause failure, malfunction, injury, or fire. When this device is repaired or modified by other than us, this device will not be covered by our guarantee.

⚠ CAUTION

- Do not touch the conductive parts of this device directly. Doing so could cause malfunction or failure of this device.
- Do not drop or apply strong impact on the case of this device, which is made of resin. Doing so could cause damage to it.
- Fix this device with the DIN rail or screws securely.
- Install this device on a flat surface.
Installing it on an uneven surface applies excessive force to internal parts, resulting in a failure.
- In case of disposal, dispose this device as an industrial waste.

2-5-1 Installing Direction

When installing this device, make sure that it is correctly oriented. The device must be installed vertically with its indicators and terminal blocks facing the operator side in order to ensure heat dissipation.

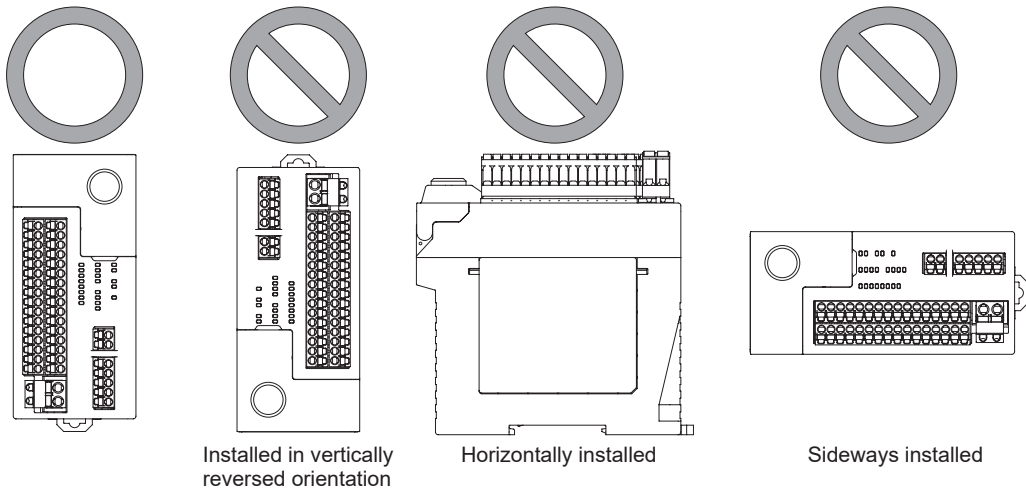

Mounting

2-5-2 Installation Space

In addition, make sure that the device's upper, lower, left, and right surfaces are spaced by 50mm or more from surrounding objects such as other devices and wiring ducts.

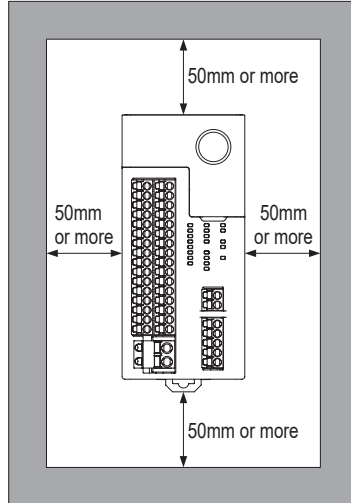

Do not install the unit above devices which generate heat such as heaters, transformers or large scale resistors.

In order to eliminate any effects from noise emission, power wires and electromagnetic devices should be kept at 100mm or more away from the surfaces of the device. When installing the unit behind the doors of the control board, be especially careful to secure clearances as above.

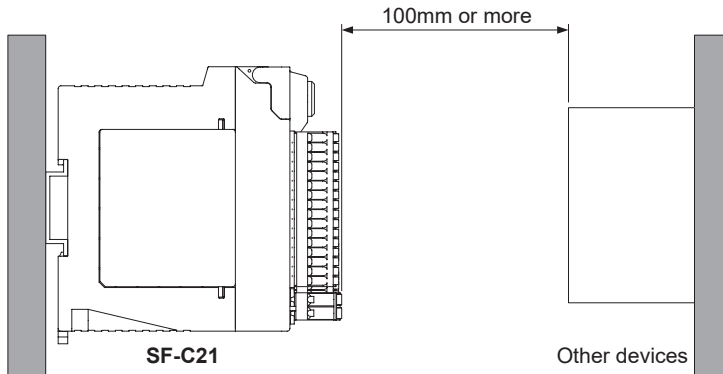

To connect the software tool and cables, keep a space of 170mm or more away from the installation surface of this device.

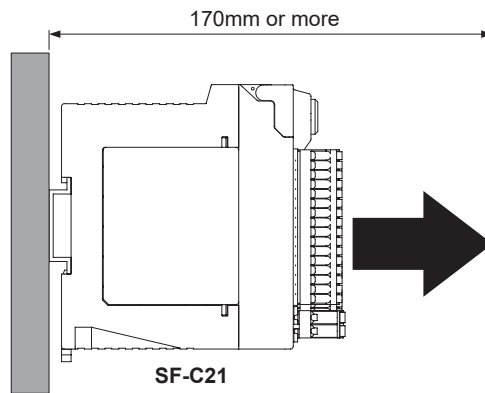

Mounting

2-5-3 Installation to and Removal from a DIN Rail

Compatible DIN rail models (based on JIS C 2812)
- TH35-7.5Al or TH35-7.5Fe

<Installing>

- Step 1 Press in the DIN rail stopper.
- Step 2 Fit the nail on the opposite side of the DIN rail stopper with the DIN rail.
- Step 3 Fit the DIN rail stopper side of the unit with the DIN rail by pressing it in.

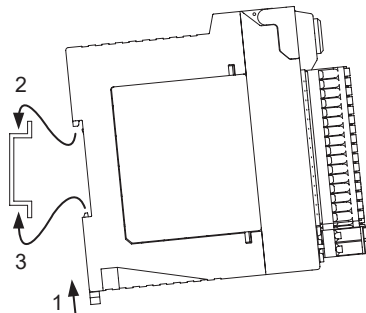

<Removing>

- Step 1 Insert the flat-head screwdriver into the groove in the DIN rail stopper.
- Step 2 Draw out the DIN rail stopper.
- Step 3 Push up the control unit toward the opposite side of the DIN rail stopper.
- Step 4 Remove the control unit by pulling its lower side while maintaining it in the pushed-up position (step 3).

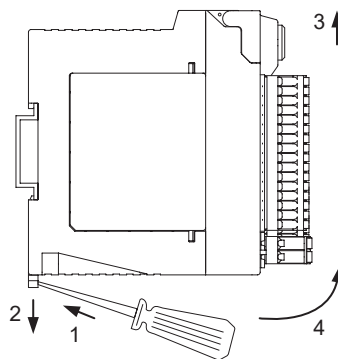

CAUTION

Do not attempt to pull the control unit without first drawing out the DIN rail stopper or the nail will break.

2-5-4 Installing the Unit Directly in a Control Panel Using Screws

The unit can be installed directly in a control panel by means of M4 pan head screws (length: 12mm or more) (purchase separately). The machine screws should be tightened with a torque of 1.2N•m or less.

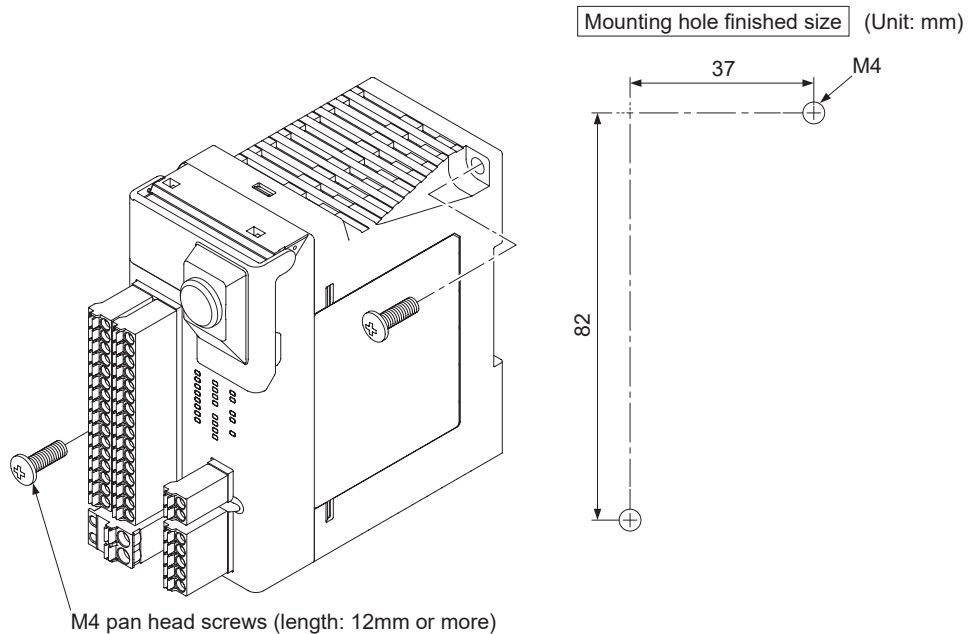

2-5-5 Installation Environment

For the installation environment, refer to “**8-1 Specifications.**”

Use the unit as per its specifications.

- Installation place: The unit is designed for use in a control panel.
- Ambient temperature: -10 to +55°C
- Ambient humidity: 30 to 85% RH (No dew condensation)
- Pollution degree: 2
- Overvoltage category: II or lower
- Usable altitude: 2,000m above sea level or lower

Wiring

2-6 Wiring

WARNING

Take countermeasure against the system to be applied for this device so as not to carry out the dangerous performance caused by the earth failure.
Failure to do so could cause invalid for the system stop, resulting in death or serious injury.

<Reference>

Use a safety relay unit or an equivalent control circuit in safety for control output 1 / 2.

2-6-1 Power Supply Unit

CAUTION

Wire correctly using a power supply unit which conforms to the laws and standards of the region where this device is to be used.
If the power supply unit is non-conforming or the wiring is improper, it can cause damage or malfunction of this device.

<Reference>

A specialist who has the required electrical knowledge should perform the wiring.

The power supply unit must satisfy the conditions given below.

- 1) Power supply unit authorized in the region where this device is to be used.
- 2) Power supply unit SELV (safety extra low voltage) / PELV (protected extra low voltage) conforming to EMC Directive and Low-voltage Directive (In case CE Marking conformity is required.)
- 3) The power supply unit must be a SELV (safety extra low voltage) / PELV (protected extra low voltage) unit that conforms to the EMC Regulations and Electrical Equipment (Safety) Regulations. (When UKCA marking is required.)
- 4) The frame ground (F.G.) terminal must be connected to ground when using a commercially available switching regulator.
- 5) Power supply unit with an output holding time of 20ms or more.
- 6) In case a surge is generated, take countermeasures such as connecting a surge absorber to the origin of the surge.
- 7) Power supply unit corresponding to CLASS 2 (In case cTÜVus Mark conformity is required.)

CAUTION

When turning ON the power supply to this device, turn ON the external power supply within 30 sec. after the internal power supply is turned ON, or turn ON the external power supply first. Delay in power ON to the external power supply locks out this device, displaying “**E Z**” in the 7-segment indicator (red).

2-6-2 I/O Circuit Diagrams

<Example: In case of using manual reset mode and external device monitor>

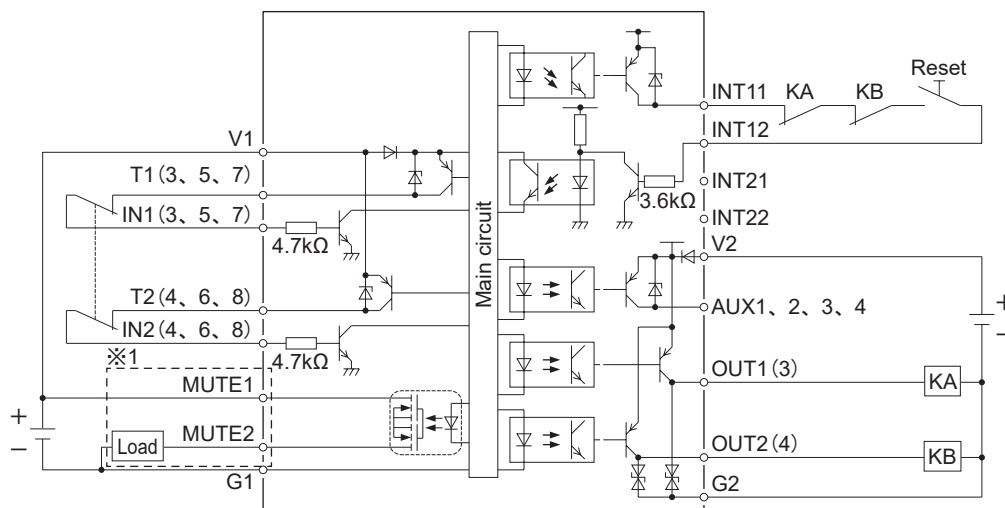

*1: Wired when muting function and override function are used.

<Reference>

KA, KB: External device (Forced guided relay, magnetic contactor, monitored valve, etc.)

<Reference>

Select contacts that can support the micro load of 6 mA at 24V DC as the reset switch and KA and KB contacts used for INT11 / 12 (INT21 / 22).

Wiring

<Output waveform [control output ON]>

When control output is turned ON, this device performs self-diagnosis of the output circuit.

The output is turned into OFF status periodically. (Refer to the figure below.)

When the OFF signal is fed back, this device judges the output circuit as normal.

When the OFF signal is not fed back, this device judges either the output circuit or wiring as error, and the control output maintains OFF status.

CAUTION

Perform the wiring with paying attention to the input response time of the machine to be connected to this device, since the OFF signal of this device might cause malfunction.

<Timing chart>

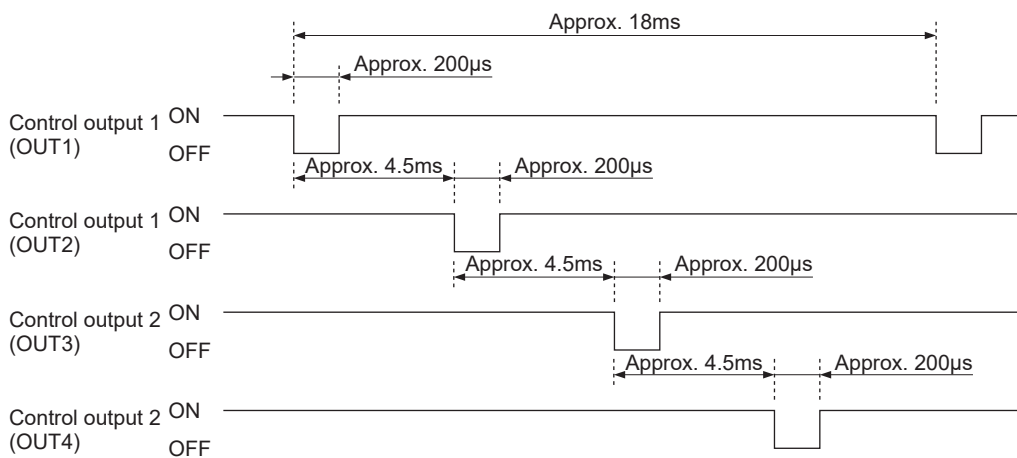

2-6-3 Connecting to the Terminal Block

- When connecting to the terminal block, insert a solid wire or a twisted wire (lead wire) with a ferrule (rod) terminal, as shown in the figure below, into the hole till it stops. (Ferrule terminals are not included in the product package.)
- The wire is locked when it is properly inserted. However, do not pull the wire with an excessive force or the cable may break.
- When connecting a twisted wire (lead wire) without using a ferrule terminal, insert the wire to the innermost of the connecting hole while pressing the release button.
- To remove the wire, draw it out while pressing the release button.

For a solid wire or a twisted wire (lead wire) to be used, refer to the table below.

Terminal block name	Terminal block model No.	Ferrule terminal			Solid wire / twisted wire			
		With an insulation sleeve (mm ²)	Without an insulation sleeve (mm ²)	Terminal length (mm)	Solid wire (mm ²)	Twisted wire (mm ²)	AWG	Stripped wire length (mm)
Terminal block for I/O 1	FMC 1,5/16-ST-3,5	0.25-0.75	0.25-1.5	10	0.2-1.0	0.2-1.5	24-16	10
Terminal block for I/O 2								
Terminal block for internal power supply	FMC 1,5/2-ST-3,5	0.25-0.75	0.25-1.5	10	0.2-1.0	0.2-1.5	24-16	10
Terminal block for RS-485	FMC 1,5/5-ST-3,5							
Terminal block for external power supply	FKC 2,5/2-ST	0.25-2.5	0.25-2.5	10	0.2-2.5	0.2-2.5	24-12	10

<Terminal block> Manufactured by Phoenix Contact

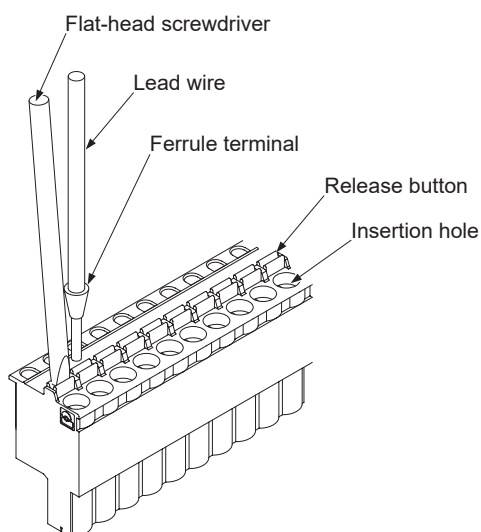

2-6-4 Connection of Safety Devices

When wiring between this device and safety devices, perform the following two points at this device to make the wiring satisfy the conditions defined in category 3 or 4.

- Duplication of I/O wires
- Implementation of self-diagnosis function (using test pulse) (excluding semiconductor output devices such as light curtain)

The functions (input, output, auxiliary output, and reset) of this device are automatically set by selecting preset logic.

Customizable logic can be created by changing preset logic in part or in whole by using the software tool. Arbitrary logics, independent of preset logic, can also be created as customizable logics.

<Reference>

Logics changed by the software tool or arbitrary logics created cannot be transferred to this device if their safety cannot be retained.

3-1 Safety Input

This device incorporates eight safety inputs. Safety inputs are comprised of four (duplex) input blocks.

- Input block 1: IN1 / IN2
- Input block 2: IN3 / IN4
- Input block 3: IN5 / IN6
- Input block 4: IN7 / IN8

The following diagnoses are carried out by setting input blocks:

Setting	With / without diagnosis (method)
2NC contact input	With diagnosis (The input devices connected to this device are diagnosed to detect earth fault, short fault to +V, or cross short fault.)
PNP semiconductor input	Without diagnosis (The input devices themselves, connected to this device, detect earth fault, short fault to +V, or cross short fault for their own outputs.)
1NO / 1NC contact input	With diagnosis (The input devices connected to this device are diagnosed to detect earth fault, short fault to +V, or cross short fault.)
1NC contact input	Without diagnosis

Devices as shown below can be connected.

- 2NC, 1NO / 1NC, or 1NC contact output type switch
- PNP transistor output sensor or switch

<Major connectable devices>

- Emergency stop switch
- Door switch (including non-contact type)
- Light curtain
- Laser scanner
- Two-hand operation switch
- Enable switch
- Key selector switch

3-1-1 Contact Input Mismatch Allowable Time

If the safety input is 2NC or 1NO / 1NC, this device simultaneously monitors ON side of two safety inputs of one system ("closed" status in the case of door switch). OFF side ("open" status in the case of door switch) cannot be monitored.

	Settable range	Initial setting
Input mismatch allowable time	0 (unlimited) to 60 sec. (in units of 0.1 sec.)	1 sec.

Functions

3-2 Control Output

This device is equipped with two independent systems (4 outputs = 2 systems × duplication) for control outputs (PNP semiconductor outputs).

- Control output 1: OUT1 / OUT2
- Control output 2: OUT3 / OUT4
 - When safe: ON status
 - When not safe / When locked out: OFF status

In the same system, two outputs perform the same operation.

3-2-1 Response Time

The maximum response time of this device is as follows:

- OFF response (ON status → OFF status): 10ms or less
- ON response (OFF status → ON status): 100ms or less

3-3 Auxiliary Output

This device is equipped with four auxiliary outputs as non-safety monitor outputs. In the case of selecting preset logic, the setting is as follows:

AUX1	Negative logic of OUT1 / OUT2
AUX2	Negative logic of OUT3 / OUT4
AUX3	Reset trigger output
AUX4	Lockout output

Each auxiliary output operation can be changed to the following output operation by using the software tool.

For details, refer to “**Chapter 5 Software Tool.**”

- Positive logic output or negative logic output of OUT1 / OUT2
- Positive logic output or negative logic output of OUT3 / OUT4
- Output A / B / C / D of diagnosis results of input block 1 / 2 / 3 / 4
- Output E / F / G of diagnosis results of internal logical circuit
- Reset trigger output
- Lockout output
- Muting indicator output
- Monitor output of IN1 to 8
- Normally OFF

3-4 Interlock (Reset)

⚠ CAUTION

When the safety input condition of this device is satisfied, the control outputs turned into ON status in the case of auto reset setting. To prevent unexpected startup of the machine, secure safety for the overall system.

<Reference>
 Select contacts that can support the micro load of 6 mA at 24V DC as the NC contacts of the momentary switch used for the interlock circuit and those of the external device monitor.

The reset function of this device is set by selection of preset logic and wiring. The software tool is available for selecting the overall reset or partial reset. For partial reset, manual reset or auto reset is selectable.

3-4-1 Overall Reset

Overall reset: preset logic No.1, 2, 3, 6, 7, and 8
 The outputs of two systems of this device are reset by one operation.

- Manual reset : Momentary type switch is connected to between INT11 and INT12.
 Resetting operation can be performed by switching the switch contact from "Close" to "Open."
- Auto reset : INT21-INT22 is short-circuited.

If between INT21 and INT22 is not short-circuited when power is turned ON, manual reset is automatically selected.

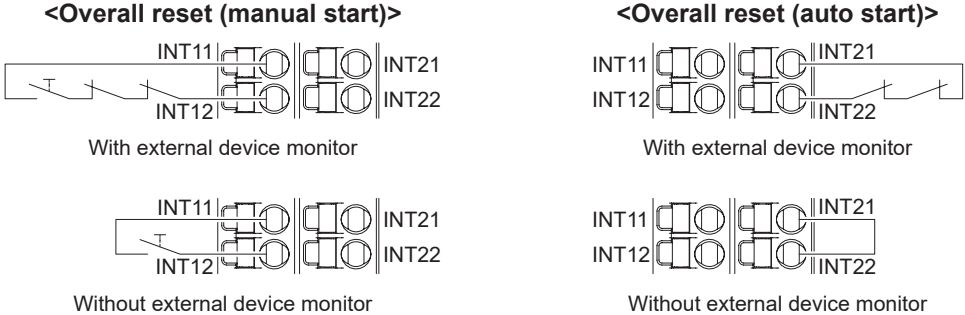

Functions

3-4-2 Partial Reset

Partial reset: Preset logic Nos. 4 and 5

Each of the outputs of two systems of this device is reset individually.

At three time of partial reset, INT11-INT12 and INT21-INT22 function are reset terminal for output control 1 (OUT1 / 2) and reset terminal for output control 2 (OUT3 / 4), respectively.

The Preset logic of this device sets manual reset. Change to auto reset can be made using software tool.

- Manual reset : Momentary type switch is connected to between INT11 and INT12 and between INT21 and INT22. Resetting operation can be performed by switching the switch contact from Close to Open.
- Auto reset : Short-circuit is made between INT11 and INT12 and between INT21 and INT22.

<Partial reset (manual start)>

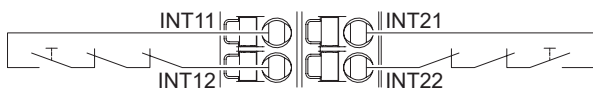

With external device monitor

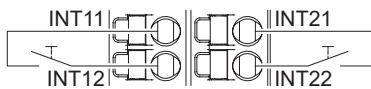

Without external device monitor

<Partial reset (auto start)>

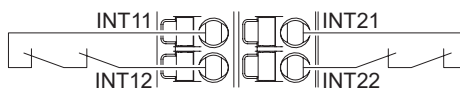

With external device monitor

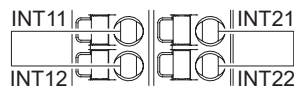

Without external device monitor

3-5 Releasing Lockout

Lockout is always released after source of error has been removed.
 Lockout is released by manually operating the switch connected to between INT11 and INT12.

- Overall reset (manual start): The reset switch functions as a lockout release switch.
 Switching the switch from “Close” to “Open” can release lockout.

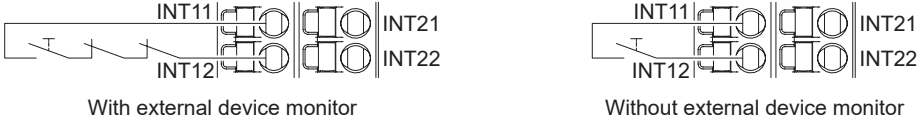

- Overall reset (auto start) :Momentary type switch is connected to between INT11 and INT12.
 When this device is put in lockout status, the switch functions as a lockout release switch.
 Switching the switch from “Close” to “Open” can release lockout.

<Reference>
 When INT11-INT12 and INT21-INT22 are simultaneously “Closed” during overall reset (auto start), “Reset input circuit error” turns this device into lockout status. In this case, “E 1” appears in 7-segment indicator (red).
 In this case, release lockout by operating the switch again to switch “Close” to “Open.”

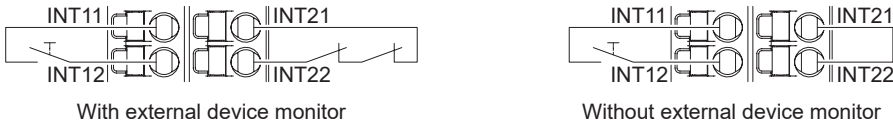

- Partial reset (auto start) :Alternate type switch is connected to between INT11 and INT12.
 Switching “from Open to Close to Open” can release lockout.
 After the release of lockout, set the switch to “Close.”

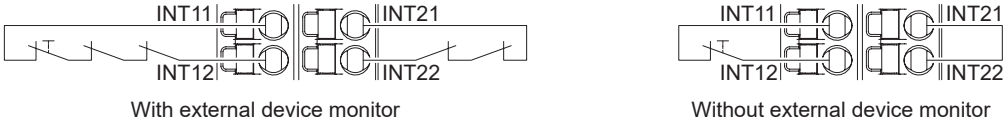

After the release of lockout, the operation is performed as follows:

- Manual reset : Manual reset turns the control output into ON status.
- Auto reset : Auto reset turns the control output into ON status.

⚠ CAUTION

When the safety input condition of this device is satisfied, release of lockout turns the control output into ON status in the case of auto reset setting. To prevent unexpected startup of the machine, secure safety for the overall system.

Functions

3-6 External Device Monitor

Operation status of the external devices connected to the control output of this device is monitored.

The NC contacts of the external devices are connected in series between INT11 and INT12 and between INT21 and INT22.

Refer to “3-4 Interlock (Reset)” and “3-5 Releasing Lockout”.

3-7 Test Input

This is used for “Check” required in control category 2 of ISO 13849-1: 2015.

When test input is effective, the control output is turned into OFF status.

This function is not incorporated into preset logic. This function is used for setting with the software tool. Refer to “5-11-1 Types of Inputs”.

The switch for 1NC contact or PNP semiconductor output (normally set to ON) is connected.

- Contact “Close” or output ON : Test input invalid
- Contact “Open” or output OFF : Test input valid

<Manual reset>

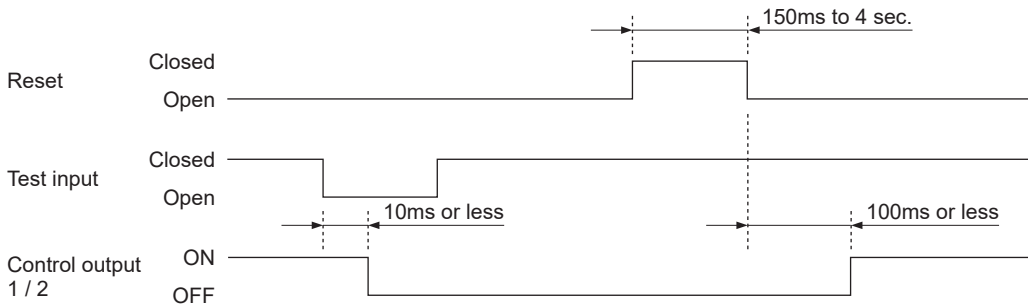

<Auto reset>

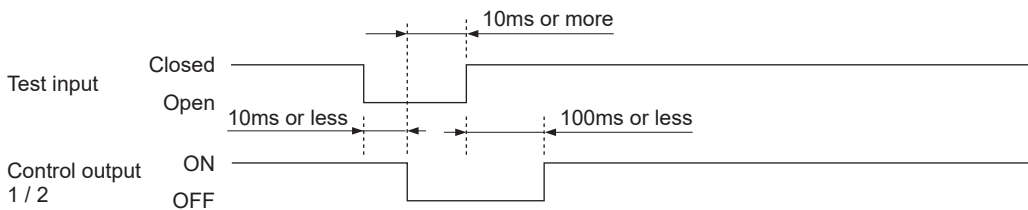

3-8 MODBUS Communication (Non-safety)

CAUTION
Communication information is not available for safety control.

Using MODBUS RTU protocol, PLC, etc., can obtain monitor information (safety input status, control output status, error information, error description, and error log) from this device. Master station (PLC, etc.) issues a command (command message) to the slave station (this device), and the slave station makes a response (response message) according to the command. For this device, up to eight units can be connected as slave stations. The communication settings are configured by using DIP switches for RS-485 on the bottom of this device or software tool.

3-8-1 MODBUS RTU Specification

Item	Setting range	Factory default
Interface	RS-485	
Maximum transmission distance	100m	
Data length	8 bits	
Communication preference setting	Either DIP switches take or software tool takes precedence	DIP switches take precedence
Parity bit presence	With or without	With
Parity bit type	Odd / even	Odd
Stop bit	1 bit / 2 bits	1 bit
Communication address	1 to 247	1
Baud rate	9,600 bps 19,200 bps 38,400 bps 57,600 bps 115,200 bps	9,600 bps

Settings by DIP switches for RS-485 (all OFF at factory setting)

DIP switches	DIP switches No.	Setting item	Input status	
			OFF	ON
	1	Communication preference setting	DIP switches take precedence	Software tool takes precedence
	2	Parity bit presence	With	Without
	3	Parity bit type	Odd	Even
	4	Stop bit	1	2
	5	Communication address 1	SW5: OFF, SW6: OFF	
	5	Communication address 2	SW5: ON, SW6: OFF	
	6	Communication address 3	SW5: OFF, SW6: ON	
	6	Communication address 4	SW5: ON, SW6: ON	
	7	Baud rate	9,600 bps	19,200 bps
	8	Unused	-	-
9	Unused	-	-	
10	Unused	-	-	

Functions

3-8-2 Wiring Example

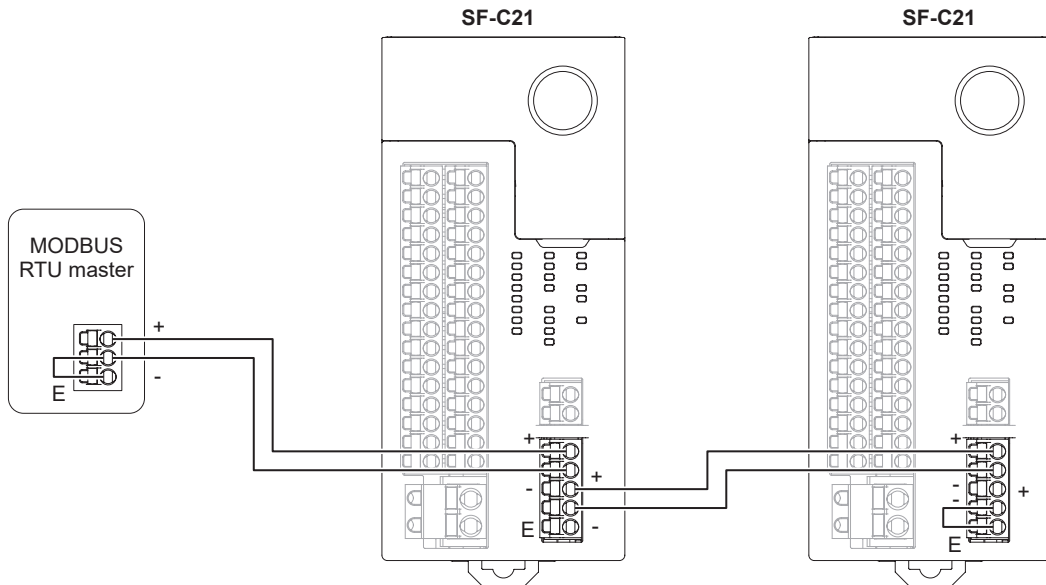

<Reference>

- When the device is used as a terminal station, short-circuit the - terminal and E terminal
- Use shielded twisted pair cables.
- The transmission line cables (shielded cables) should be connected in a crossover fashion and grounded at one end.

Classification	Conductor		Insulator		Cable diameter (mm)	Applicable cable example
	Size	Resistance value (At 20°C)	Material	Thickness (mm)		
Shielded twisted pair	0.5 mm ² (AWG 20) or more	Up to 33.4 Ω/km	Polyethylene	Up to 0.5	Approx. 7.8	Hitachi Cable, Ltd. KPEV-S0.5 mm ² ×1P Belden Inc. 9207

3-8-3 Function Code

Configuration of communication data

Office No.
Function code
Data
CRC-16

Function code

Function code	Function
0x01	Reading coil (output) status
0x02	Reading relay (input) status
0x03	Reading holding register
0x81	Error in reading coil (output) status
0x82	Error in reading relay (input) status
0x83	Error in reading holding register

3-8-4 Error Codes

Configuration of communication data

Office No.
Function code
Error code
CRC-16

Error code

Error code	Description
0x01	Function code error
0x02	Address error
0x03	Data quantity error

Functions

3-8-5 Address Map

			Bit address	Word address
Input	IN1	Safety input 1	0x0000	0x0000
	IN2	Safety input 2	0x0001	
	IN3	Safety input 3	0x0002	
	IN4	Safety input 4	0x0003	
	IN5	Safety input 5	0x0004	
	IN6	Safety input 6	0x0005	
	IN7	Safety input 7	0x0006	
	IN8	Safety input 8	0x0007	
	INT1	Reset input 1	0x0010	0x0001
INT2	Reset input 2	0x0011		
Output	OUT1	Control output 1	0x1000	0x0100
	OUT2		0x1001	
	OUT3	Control output 2	0x1002	
	OUT4		0x1003	
	AUX1	Auxiliary output 1	0x1010	0x0101
	AUX2	Auxiliary output 2	0x1011	
	AUX3	Auxiliary output 3	0x1012	
	AUX4	Auxiliary output 4	0x1013	
	MUTE	Muting indicator output	0x1014	
Holding register	IN1/2	Input block 1	–	0x1000
	IN3/4	Input block 2	–	0x1001
	IN5/6	Input block 3	–	0x1002
	IN7/8	Input block 4	–	0x1003
	LOGIC1	Control block 1	–	0x1100
	LOGIC2	Control block 2	–	0x1101
	LOGIC3	Control block 3	–	0x1102
	ER1	Lockout history (Latest)	–	0x1200
	ER2	Lockout history (1 save ago)	–	0x1201
	ER3	Lockout history (2 saves ago)	–	0x1202
	ER4	Lockout history (3 saves ago)	–	0x1203
	ER5	Lockout history (4 saves ago)	–	0x1204
	LR1	Logic No. history (Latest)	–	0x1300
	LR2	Logic No. history (1 save ago)	–	0x1301
	LR3	Logic No. history (2 saves ago)	–	0x1302
	LR4	Logic No. history (3 saves ago)	–	0x1303
	LR5	Logic No. history (4 saves ago)	–	0x1304
	DR1	OFF delay No. history (Latest)	–	0x1400
	DR2	OFF delay No. history (1 save ago)	–	0x1401
	DR3	OFF delay No. history (2 saves ago)	–	0x1402
	DR4	OFF delay No. history (3 saves ago)	–	0x1403
	DR5	OFF delay No. history (4 saves ago)	–	0x1404
	RRQ	Reset request status	–	0x2000
	MUT	Muting condition satisfaction status	–	0x2001

3-8-6 Message Format

- **Function code: 0x01**
<Command>

Data	Description
Office No.	SF-C21 equipment address
Function code	0x01
Reading start address (H)	Bit address to read data from
Reading start address (L)	
Read number (H)	Quantity of data to be read
Read number (L)	
CRC-16 (H)	Message error judgment data
CRC-16 (L)	

<Response during normal operation>

Data	Description
Office No.	SF-C21 equipment address
Function code	0x01
Number of bytes of communication data	Number of bytes of communication data
Data 1 to be read	Data to be read
⋮	
Data n to be read	
CRC-16 (H)	Message error judgment data
CRC-16 (L)	

<Response during abnormal operation>

Data	Description
Office No.	SF-C21 equipment address
Function code	0x81
Error code	Error code
CRC-16 (H)	Message error judgment data
CRC-16 (L)	

Functions

3-8-7 Function Code

- **Function code: 0x02**

<Command>

Data	Description
Office No.	SF-C21 equipment address
Function code	0x02
Reading start address (H)	Bit address to read data from
Reading start address (L)	
Read number (H)	Quantity of data to be read
Read number (L)	
CRC-16 (H)	Message error judgment data
CRC-16 (L)	

<Response during normal operation>

Data	Description
Office No.	SF-C21 equipment address
Function code	0x02
Number of bytes of communication data	Number of bytes of communication data
Data 1 to be read	Data to be read
⋮	
Data n to be read	
CRC-16 (H)	Message error judgment data
CRC-16 (L)	

<Response during abnormal operation>

Data	Description
Office No.	SF-C21 equipment address
Function code	0x82
Error code	Error code
CRC-16 (H)	Message error judgment data
CRC-16 (L)	

● **Function code: 0x03**

<Command>

Data	Description
Office No.	SF-C21 equipment address
Function code	0x03
Reading start address (H)	Word address to read data from
Reading start address (L)	
Read number (H)	Quantity of data to be read
Read number (L)	
CRC-16 (H)	Message error judgment data
CRC-16 (L)	

<Response during normal operation>

Data	Description
Office No.	SF-C21 equipment address
Function code	0x03
Number of bytes of communication data	Number of bytes of communication data
Data 1 to be read (H)	Data to be read
Data 1 to be read (L)	
:	
Data n to be read (H)	
Data n to be read (L)	
CRC-16 (H)	Message error judgment data
CRC-16 (L)	

<Response during abnormal operation>

Data	Description
Office No.	SF-C21 equipment address
Function code	0x83
Error code	Error code
CRC-16 (H)	Message error judgment data
CRC-16 (L)	

Functions

3-9 USB Communication

CAUTION
Connections to this device via USB are assumed to include temporary connections for e.g., logic settings and diagnoses. Constant connections via USB are not allowed.

When this device is connected to PC via a USB cable, various information of this device can be transmitted and received by using the software tool “**Configurator SF-C.**”

For details, refer to “**Chapter 5 Software Tool.**”

3-10 Logic Selection Function

CAUTION

For the safety of the overall system and the conformity to the standards applicable in each region or country in which this device is installed, take actions on the customer's own responsibility.

This device incorporates eight preset logics and one customizable logic. The preset logics and customizable logics comply with related international standards.

<No.1. Overall stop control>

Logic diagram

Description of settings	Input	IN1 / IN2	2NC contact input	IN5 / IN6	2NC contact input
		IN3 / IN4	2NC contact input	IN7 / IN8	2NC contact input
Control output	OUT1 / 2		Interlock		Overall reset
			OFF delay		0 sec. (Note 1)
	OUT3 / 4		Interlock		Overall reset
			OFF delay		0 sec. (Note 2)
Auxiliary output	AUX1	Negative logic of OUT 1 / 2		AUX3	Reset trigger
	AUX2	Negative logic of OUT 3 / 4		AUX4	Lockout

Notes: 1) Fixed at 0 sec.
 2) Time can be selected using this device. For details, refer to "3-11 OFF Delay Time Selection Function."

<Timing chart>

• When auto reset is set

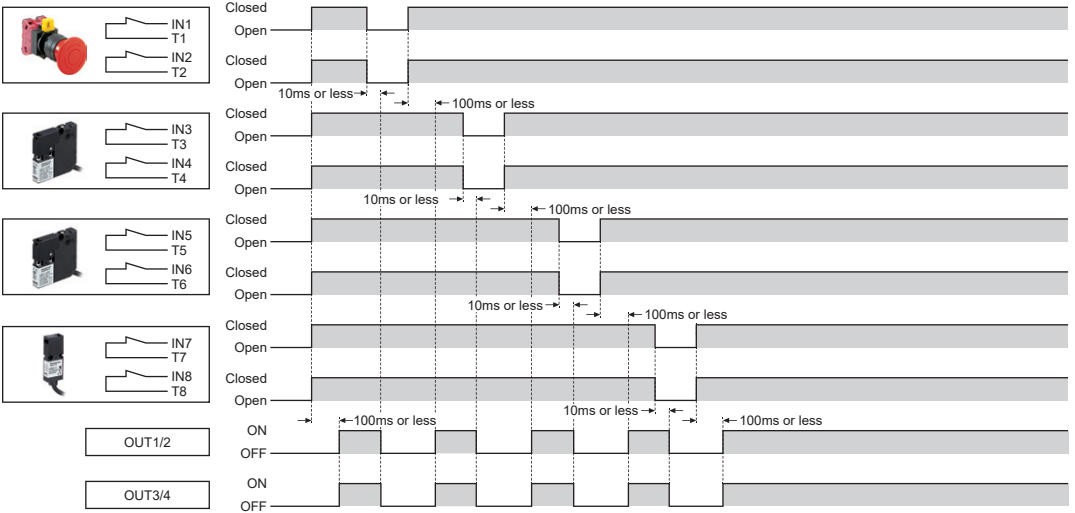

Functions

[No.2: Parallel muting control]

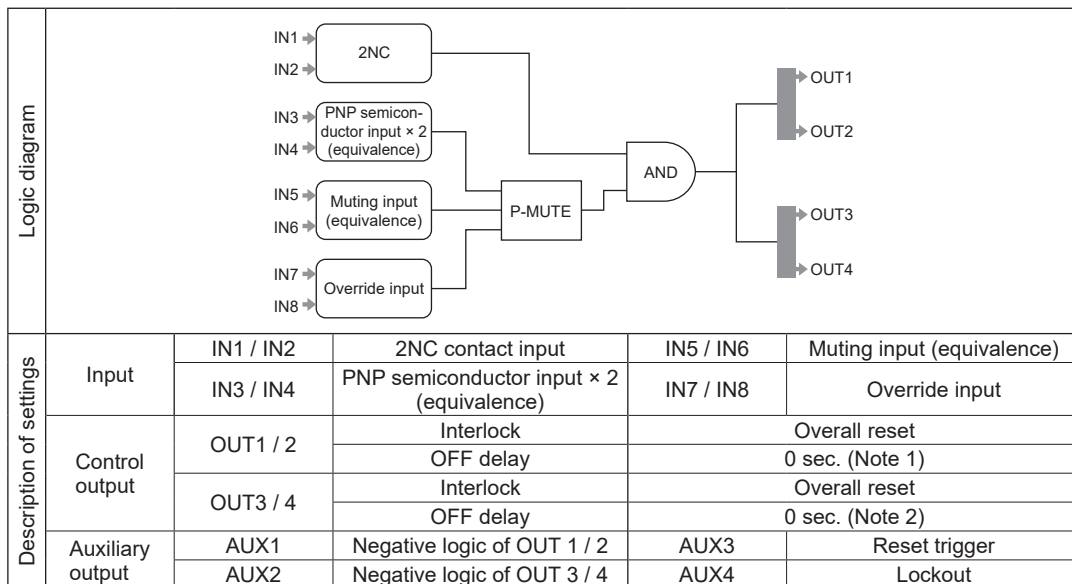

Notes: 1) Fixed at 0 sec.
 2) Time can be selected using this device. For details, refer to “3-11 OFF Delay Time Selection Function.”

<Timing chart>

• When auto reset is set

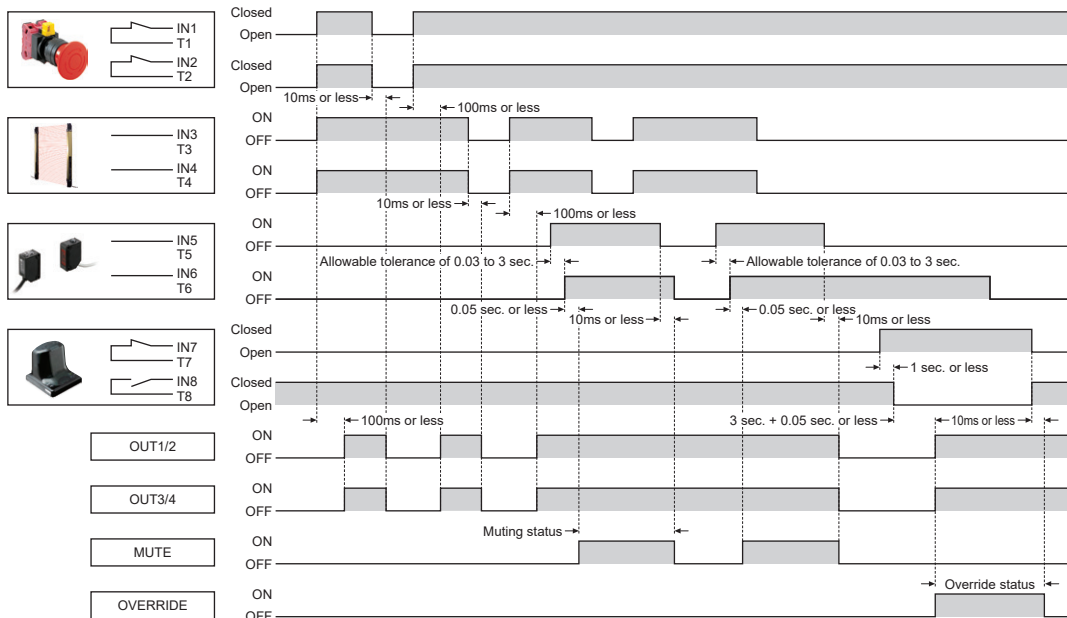

Note: Regarding the muting / override settings, refer to the factory default settings shown in “3-12 Logic Settings by Software Tool.”

[No.3. Sequential muting control]

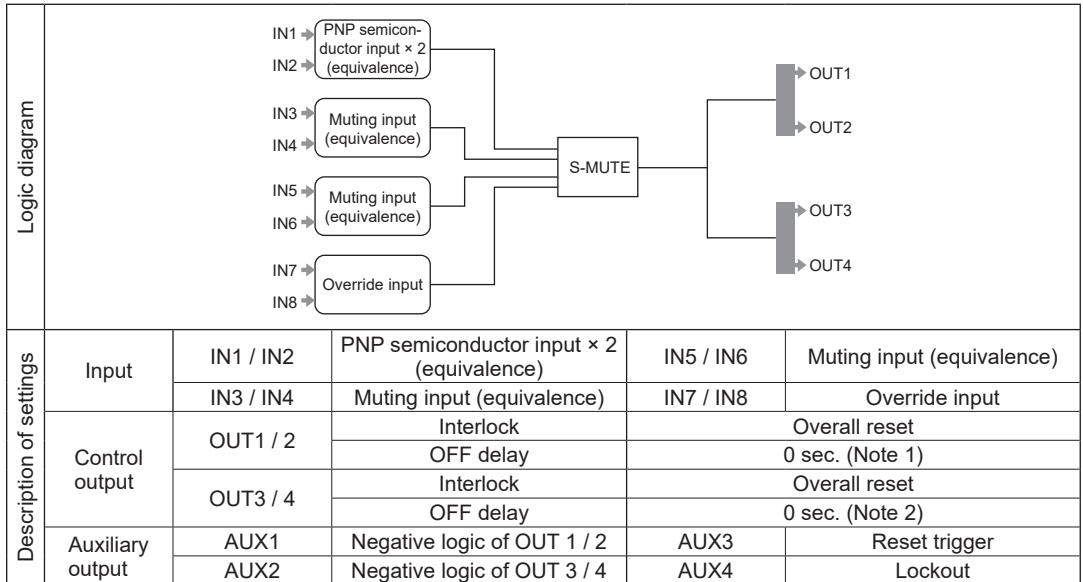

Notes: 1) Fixed at 0 sec.

2) Time can be selected using this device. For details, refer to “3-11 OFF Delay Time Selection Function.”

<Timing chart>

• When auto reset is set

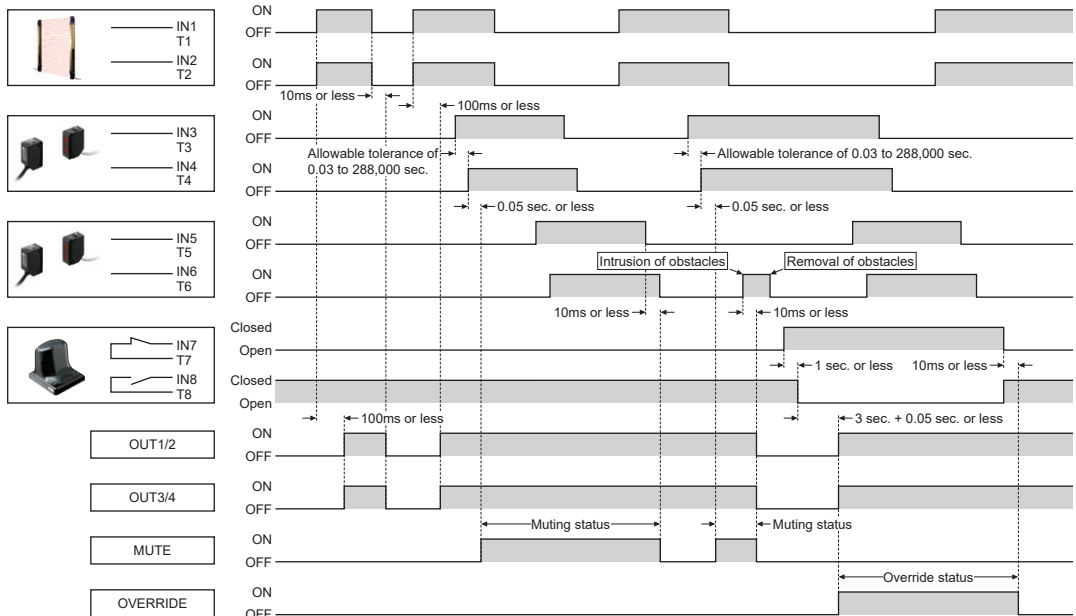

Note: Regarding the muting / override settings, refer to the factory default settings shown in “3-12 Logic Settings by Software Tool.”

Functions

[No.4. Partial stop control 1]

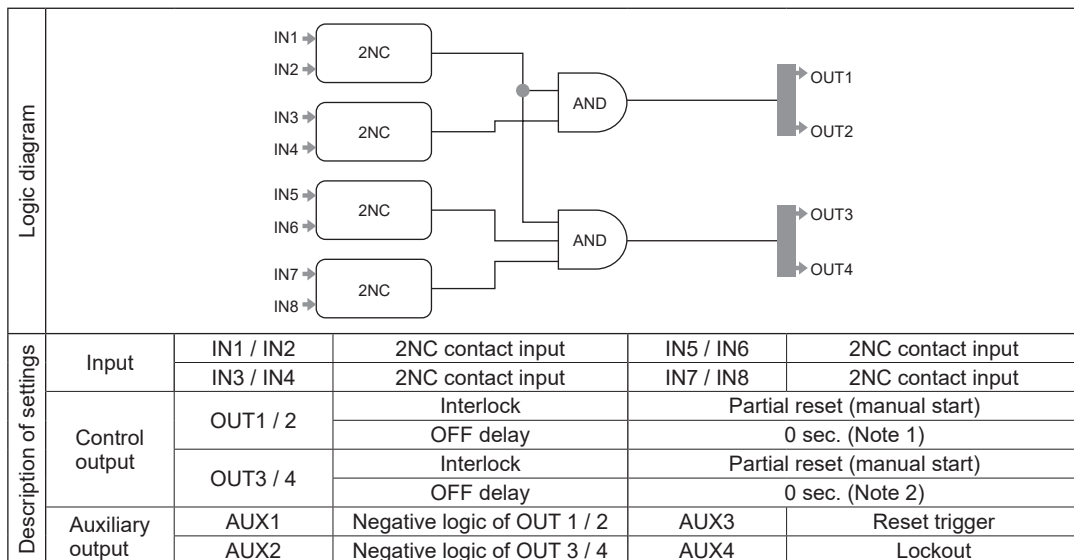

Notes: 1) Fixed at 0 sec.
 2) Time can be selected using this device. For details, refer to "3-11 OFF Delay Time Selection Function."

<Timing chart>

• Manual reset (standard setting)

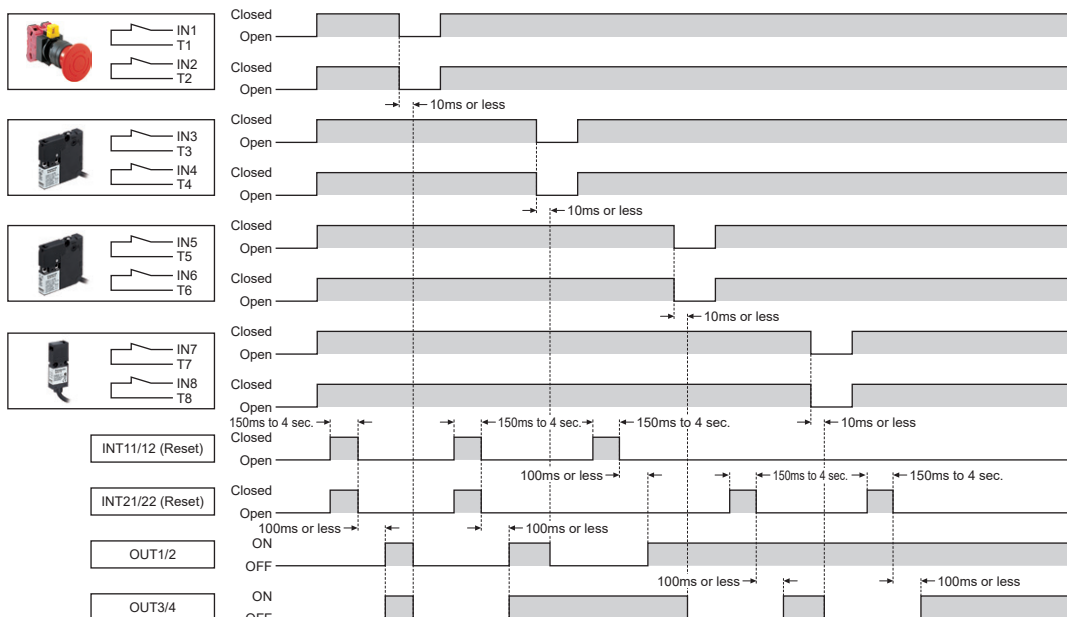

[No.5. Partial stop control 2]

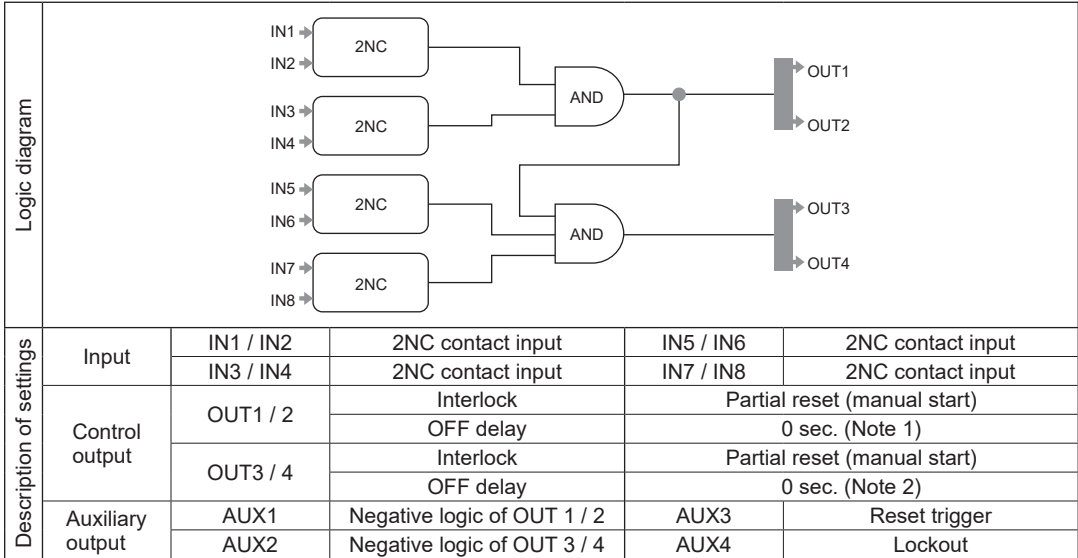

Notes: 1) Fixed at 0 sec.
 2) Time can be selected using this device. For details, refer to "3-11 OFF Delay Time Selection Function."

<Timing chart>

• Manual reset (standard setting)

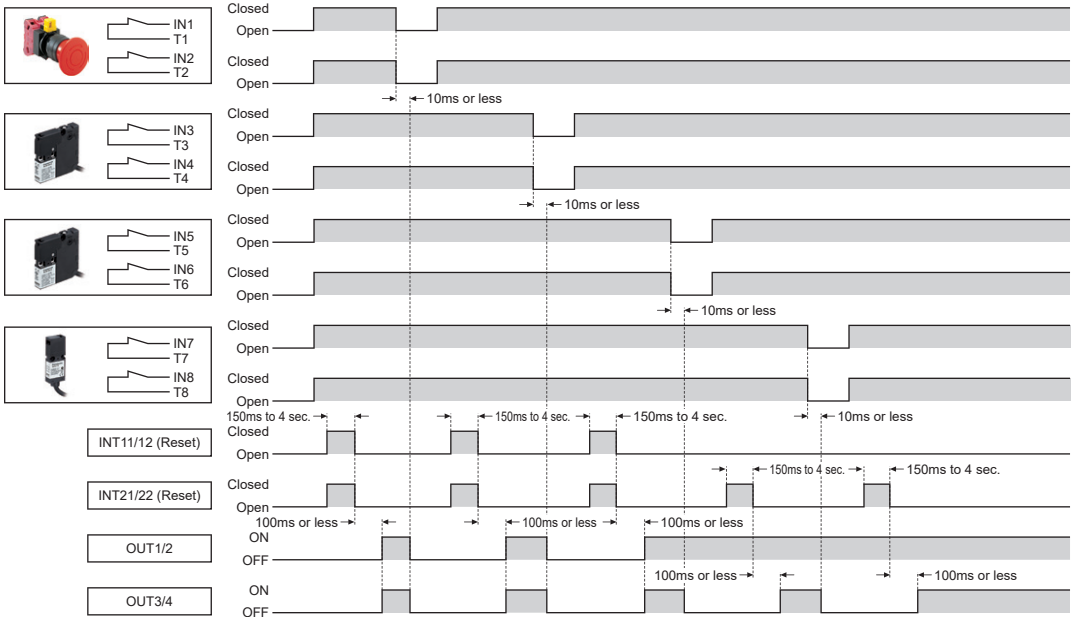

Functions

[No.6. Two-hand control]

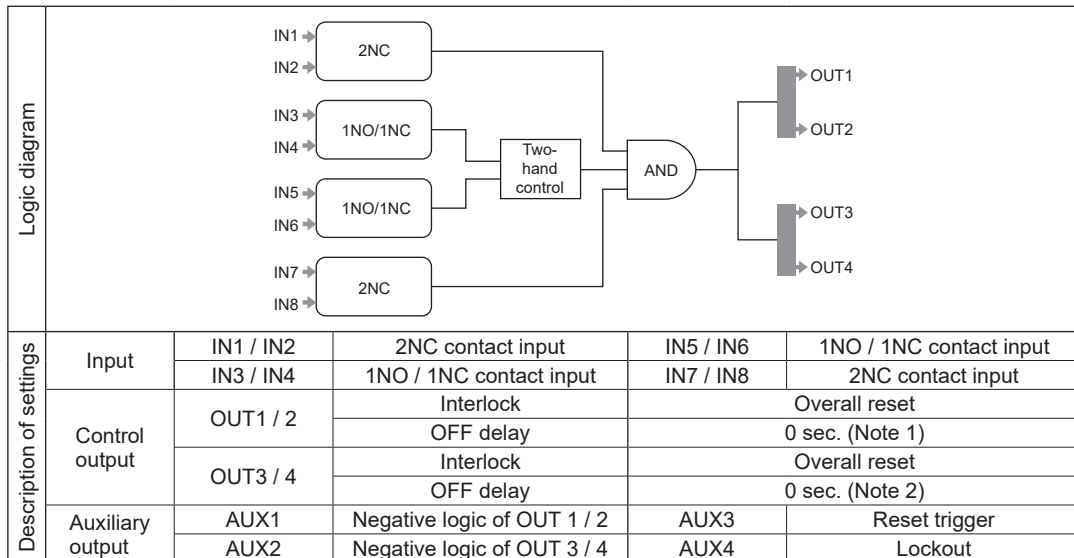

Notes: 1) Fixed at 0 sec.
 2) Time can be selected using this device. For details, refer to "3-11 OFF Delay Time Selection Function."

<Timing chart>

• When auto reset is set

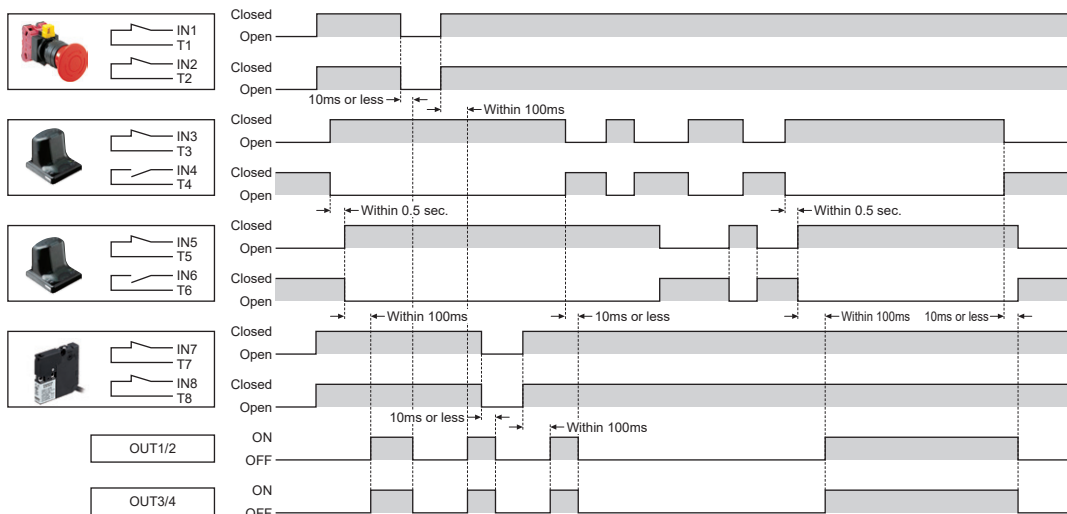

[No.7. OR control]

Logic diagram																																								
	<table border="1"> <tr> <td rowspan="2">Input</td> <td>IN1 / IN2</td> <td>2NC contact input</td> <td>IN5 / IN6</td> <td>2NC contact input</td> </tr> <tr> <td>IN3 / IN4</td> <td>2NC contact input</td> <td>IN7 / IN8</td> <td>2NC contact input</td> </tr> <tr> <td rowspan="2">Control output</td> <td>OUT1 / 2</td> <td>Interlock</td> <td colspan="2">Overall reset</td> </tr> <tr> <td></td> <td>OFF delay</td> <td colspan="2">0 sec. (Note 1)</td> </tr> <tr> <td rowspan="2">Auxiliary output</td> <td>OUT3 / 4</td> <td>Interlock</td> <td colspan="2">Overall reset</td> </tr> <tr> <td></td> <td>OFF delay</td> <td colspan="2">0 sec. (Note 2)</td> </tr> <tr> <td rowspan="2">Auxiliary output</td> <td>AUX1</td> <td>Negative logic of OUT 1 / 2</td> <td>AUX3</td> <td>Reset trigger</td> </tr> <tr> <td>AUX2</td> <td>Negative logic of OUT 3 / 4</td> <td>AUX4</td> <td>Lockout</td> </tr> </table>					Input	IN1 / IN2	2NC contact input	IN5 / IN6	2NC contact input	IN3 / IN4	2NC contact input	IN7 / IN8	2NC contact input	Control output	OUT1 / 2	Interlock	Overall reset			OFF delay	0 sec. (Note 1)		Auxiliary output	OUT3 / 4	Interlock	Overall reset			OFF delay	0 sec. (Note 2)		Auxiliary output	AUX1	Negative logic of OUT 1 / 2	AUX3	Reset trigger	AUX2	Negative logic of OUT 3 / 4	AUX4
Input	IN1 / IN2	2NC contact input	IN5 / IN6	2NC contact input																																				
	IN3 / IN4	2NC contact input	IN7 / IN8	2NC contact input																																				
Control output	OUT1 / 2	Interlock	Overall reset																																					
		OFF delay	0 sec. (Note 1)																																					
Auxiliary output	OUT3 / 4	Interlock	Overall reset																																					
		OFF delay	0 sec. (Note 2)																																					
Auxiliary output	AUX1	Negative logic of OUT 1 / 2	AUX3	Reset trigger																																				
	AUX2	Negative logic of OUT 3 / 4	AUX4	Lockout																																				

Notes: 1) Fixed at 0 sec.
 2) Time can be selected using this device. For details, refer to "3-11 OFF Delay Time Selection Function."

<Timing chart>

• When auto reset is set

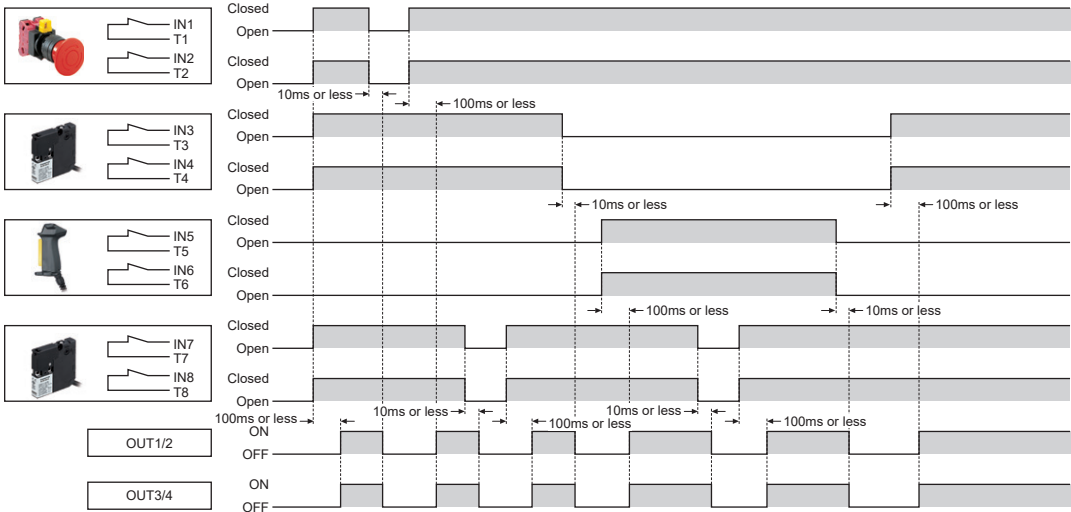

Functions

[No.8. Operation mode selection control]

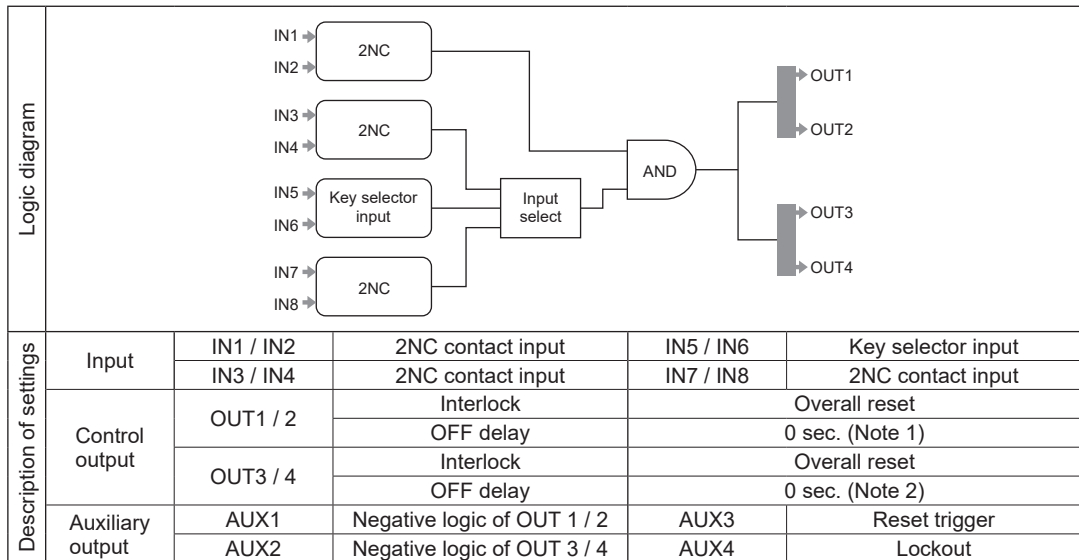

Notes: 1) Fixed at 0 sec.

2) Time can be selected using this device. For details, refer to "3-11 OFF Delay Time Selection Function."

<Timing chart>

• When auto reset is set

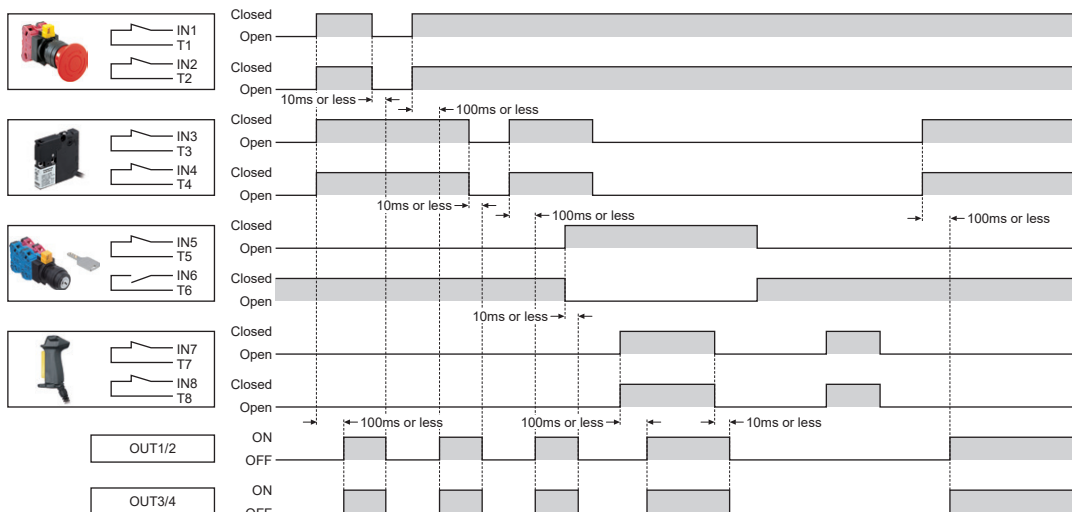

3-11 OFF Delay Time Selection Function

The OFF delay times that this device can set are as follows:

No.	OFF delay time	Stop category
0	0 sec.	0
1	0.1 sec.	1
2	0.5 sec.	
3	1 sec.	
4	2 sec.	
5	5 sec.	
6	10 sec.	
7	15 sec.	
8	30 sec.	
9	60 sec.	

Note: Only OUT3 / 4 can be set with this device.

Functions

3-12 Logic Settings by Software Tool

The software tool is available to change the settings of the following items. When logics are set, control output 1 / 2 maintains OFF status. For details, refer to “**Chapter 5 Software Tool.**”

<Setting item>

- Input mode
- Logic setting
- Output mode (OFF delay, reset)
- Auxiliary output mode

<Detailed setting item>

- Input mismatch allowable time
- Input filter time
- ON delay time
- Allowable time difference in muting input
- Muting duration
- Exit-only muting time
- Muting input condition
- Override duration
- MODBUS (RS-485) communication conditions (Baud rate, parity bit presence, parity bit type, stop bit, and communication address)

Item		Setting range	Factory default (Note 1)
Input mismatch allowable time		0 (unlimited) to 60 sec. (in units of 0.01 sec.)	1 sec.
Input filter time	ON - OFF	0 to 1 sec. (in units of 0.01 sec.)	0 sec.
	OFF - ON		
ON delay time		0 to 5,940 sec. (in units of 0.1 sec.)	0 sec.
OFF delay time		0 to 60 sec. (in units of 0.1 sec.)	0 sec.
Allowable time difference in muting input	Parallel muting	1 to 10 sec. (in units of 1 sec.)	3 sec.
	Sequential muting	0 (unlimited) to 288,000 sec. (in units of 1 sec.)	288,000 sec.
Muting duration		0 (unlimited) to 5,940 sec. (in units of 1 sec.)	5,940 sec.
Exit-only muting time (Note 2)		1 to 4 sec. (in units of 0.1 sec.)	0 sec.
Muting input condition		No priority/A priority/B (D) Priority	No priority
Override duration		1 to 600 sec. (in units of 1 sec.)	60 sec.
RS-485 communication condition	Baud rate	9,600 bps to 115,200 bps	9,600 bps
	Parity bit presence	Without / With	With
	Parity bit type	Odd / even	Odd
	Stop bit	1 bit / 2 bits	1 bit
Communication address		1 to 247	1

Notes: 1) Preset logic is fixed.

2) This setting is only for parallel muting.

Factory settings of customizable logics are invalid.

3-13 Logic Manual Stop / Start Function

The logics of this device can be stopped and started manually.
The logics of this device are stopped according to the procedure below.

Step 1 Switch the mode selector switch to the "PROG" side.

Step 2 Press the rotary switch.

The logics of this device are started according to the procedure below.

Step 1 Switch the mode selector switch to the "RUN" side.

Step 2 Press the rotary switch.

Chapter 4 Setting of Logics

4-1 Types and Settings of Logics

For this device, logic Nos. 0 to 9 and nine types of OFF delay time can be specified. With logic No. 0 specified, the logic is customizable. This device must be connected to a PC to make settings with a software tool.

Logics corresponding to Nos. are shown in the table below.

No.	Logic
0	Customizable logic
1	Overall stop control
2	Parallel muting control
3	Sequential muting control
4	Partial stop control 1
5	Partial stop control 2
6	Two-hand control
7	OR control
8	Operation mode selection control

OFF delay times and stop categories corresponding to Nos. are shown in the table below.

No.	OFF delay time	Stop category
0	0 sec.	0
1	0.1 sec.	1
2	0.5 sec.	
3	1 sec.	
4	2 sec.	
5	5 sec.	
6	10 sec.	
7	15 sec.	
8	30 sec.	
9	60 sec.	

4-1-1 Factory Setting

Factory setting of this device is as shown in the table below.

Item	Factory setting
Logic	1
OFF delay time No.	0
Password 1	00
Password 2	00

4-2 Preparation for Logic Setting

Preset logic can be set by using this device and power supply only. At the time of setting, devices do not have to be connected to the input section or output section. Connect power supplies (24V DC and 0V) to the terminal block for internal power supply and the terminal block for external power supply in this device. If power is supplied to either one of them, this device will not operate.

4-2-1 Turning ON the Power

Confirm that the mode selector switch is turned to the “RUN” side (left side: factory setting) and then turn ON the power. The diagnosis function of this device carries out initial diagnosis, turning ON and OFF the indicators one by one.

After the end of initial diagnosis, the operation indicator (green) lights up.

If a terminal block is connected only to the power supply, auxiliary output indicator 1 / 2 / 4 (orange) and interlock indicator 1 / 2 (yellow) light up.

The other indicators turn OFF.

Pressing the rotary switch displays “ f ” (factory setting) in the 7-segment indicator (red), turning ON the logic selection indicator (orange).

4-2-2 Portions Used in Settings

The following indicators and switches are used for preset logic settings.

- 7-segment indicator (Red)
- Logic selection indicator (Orange)
- Delay selection indicator (Orange)
- Password selection indicator (Orange)
- Operation indicator (Green)
- Setting indicator (Orange)
- Rotary switch
- Mode selector switch

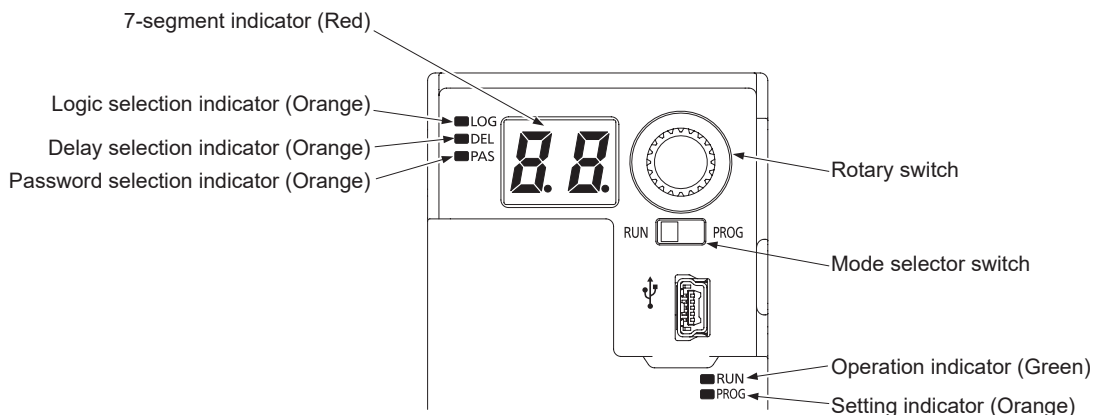

Operation in RUN Mode and the Display

4-3 Operation in RUN Mode and the Display

4-3-1 Operation and Display During Normal Operation

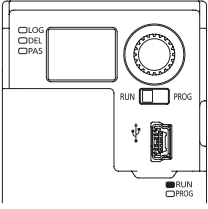
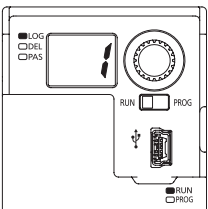
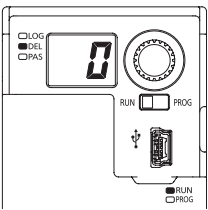
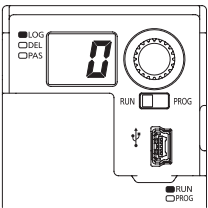
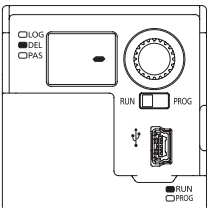
Step	Status of indicators and switches	Description
1		<p>Mode selector switch: RUN side Operation indicator (green): Lights up</p> <p>The power saving function of this device turns OFF the 7-segment indicator (red) 3 sec. after power ON, the end of initial diagnosis, or final operation.</p>
2		<p>Press the rotary switch.</p> <p>The logic No. currently set is displayed in the 7-segment indicator (red). Logic selection indicator (orange) lights up.</p> <p>“ f: Overall stop control” is set at factory.</p>
3		<p>Rotate the rotary switch.</p> <p>The currently set No. for OFF delay time is displayed in the 7-segment indicator (red). Delay selection indicator (orange) lights up.</p> <p>“ 0: 0 sec.” is set at factory.</p> <p>Rotating the rotary switch returns to No.1.</p>
4		<p>Logic No. 0 is customizable logic.</p> <p>To use customizable logic, this device must be connected to a PC to make settings by a software tool. Refer to “Chapter 5 Software Tool”.</p>
5		<p>Selecting logic No. 0 always displays “ - ” in the 7-segment indicator (red) as the OFF delay time.</p>

4-3-2 Display When an Error Occurs

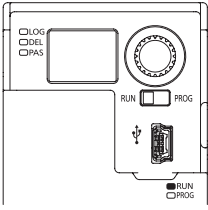
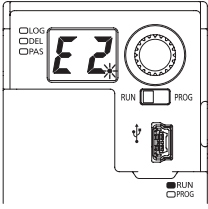
Step	Status of indicators and switches	Description
1		<p>Mode selector switch: RUN side Operation indicator (green): Lights up</p> <p>During normal operation</p> <p>The power saving function of this device turns OFF the 7-segment indicator (red) 3 sec. after power ON, the end of initial diagnosis, or final operation.</p>
2		<p>Occurrence of abnormality (Example: internal failure, two inputs short-circuited, etc.) If an error occurs, an error code is displayed in the 7-segment indicator (red), and dots blink.</p> <p>Either one of error codes “E 1” to “E 9” and “E F.” is displayed in the 7-segment indicator (red). For the error codes, refer to “Chapter 7 Troubleshooting”.</p>

Setting of Logics and OFF Delay Time

4-4 Setting of Logics and OFF Delay Time

4-4-1 Flowchart of Logic and OFF Delay Time

Logic and OFF delay time are set according to the flow in the figure below.

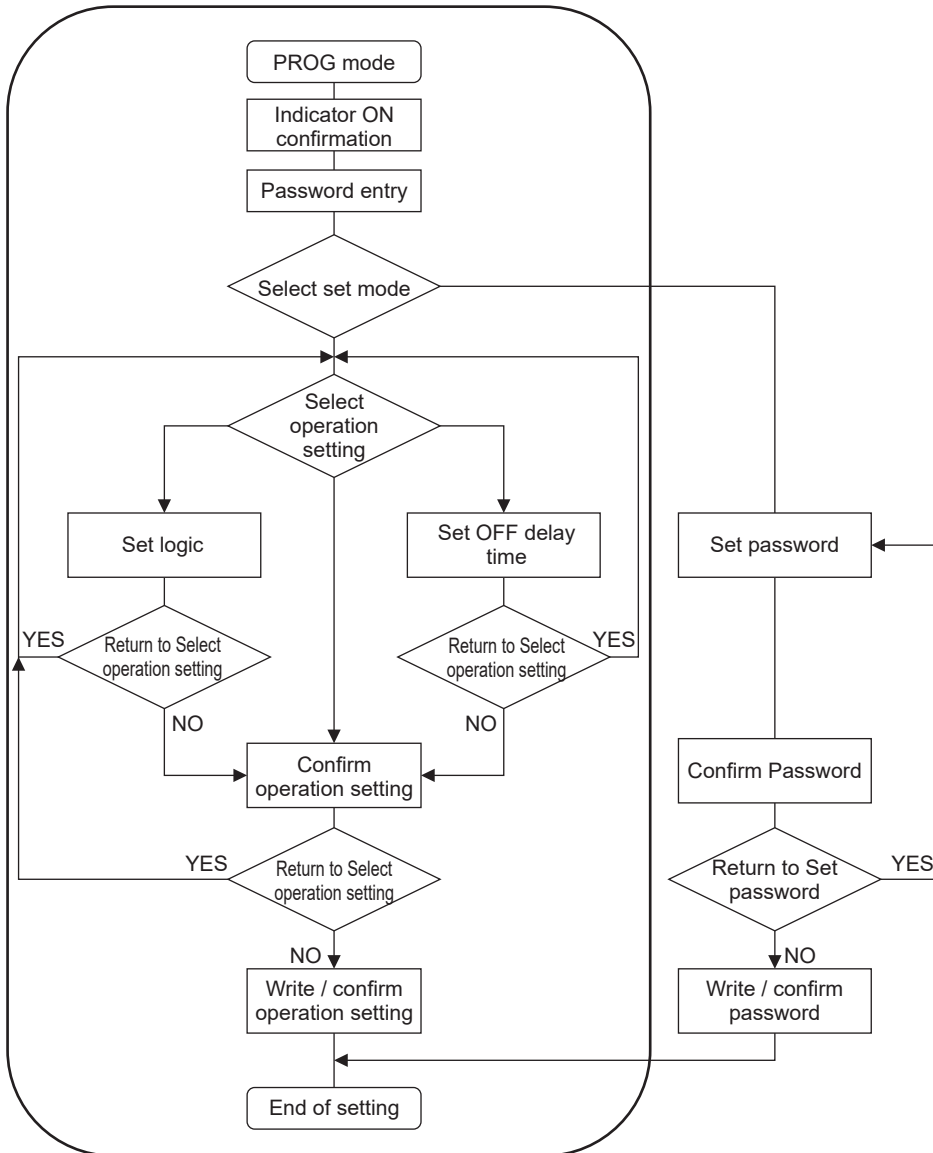

4-4-2 Operation Procedure for Setting Logic and OFF Delay Time

Procedure for setting logic and OFF delay time in this device is described below.
 To stop setting logic and OFF delay time before Step 23 in the table below, turn the mode selector switch to the "RUN" side, and the settings will be canceled. After Step 24 or later, the settings cannot be canceled.

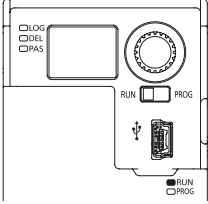
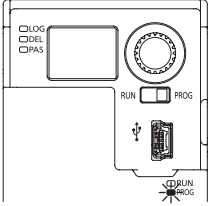
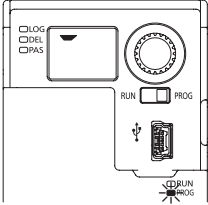
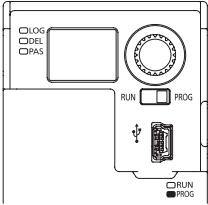
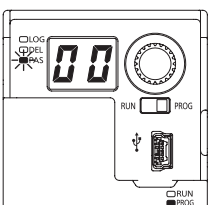
Step	Status of indicators and switches	Description
1		<p>Mode selector switch: RUN side Operation indicator (green): Lights up</p> <p>The power saving function of this device turns OFF the 7-segment indicator (red) 3 sec. after power ON, the end of initial diagnosis, or final operation.</p>
2		<p>Switch the mode selector switch to the "PROG" side. This device transitions to "PROG mode."</p> <p>The operator indicator (green) turns OFF. The setting indicator (orange) blinks.</p>
3		<p>This device automatically transitions to "Indicator ON confirmation."</p> <p>Individual segments of the 7-segment indicator (red) light up one by one. Check for an error code displayed in the 7-segment indicator (red). Press the rotary switch.</p>
4		<p>The setting indicator (orange) status changes from blinking to lighting up. Press the rotary switch.</p>
5		<p>Transition to "Enter password."</p> <p>Password selection indicator (orange) blinks. Password 1 "00" is displayed in the the 7-segment indicator (red).</p> <p>Enter password 1 and password 2. At factory, password 1 is set to "00", password 2, "00".</p>

Setting of Logics and OFF Delay Time

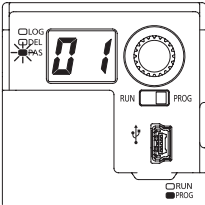
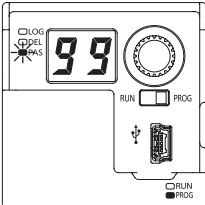
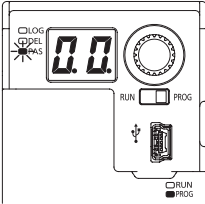
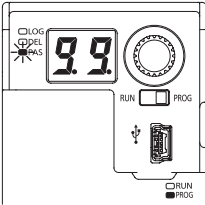
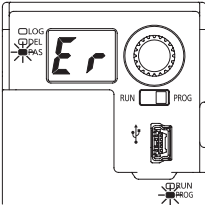
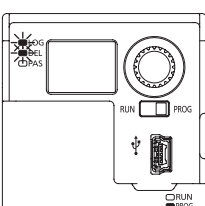
Step	Status of indicators and switches	Description
6		<p>Select password. Select a number by rotating the rotary switch.</p>
7		<p>Select password 1 from "00" to "99". Determine password 1 by pressing the rotary switch.</p>
8		<p>Password 2 "00" is displayed in the the 7-segment indicator (red). Select password 2. Similarly, select a number by rotating the rotary switch.</p>
9		<p>Select password 2 from "00" to "99". Determine the password 2 by pressing the rotary switch.</p> <ul style="list-style-type: none"> • When password 1 and password 2 are correct, proceed to Step 11. • When password 1 or 2 is incorrect, proceed to Step 10.
10		<p>"Er" is displayed in the 7-segment indicator (red). Pressing the rotary switch returns to Step 5. Enter the password again.</p>
11		<p>Transition to "Select setting mode."</p> <p>Password selection indicator (orange) turns OFF. The logic selection indicator (orange) and delay selection indicator (orange) blink.</p> <p>Pressing the rotary switch proceeds to Step 13.</p>

Setting of Logics and OFF Delay Time

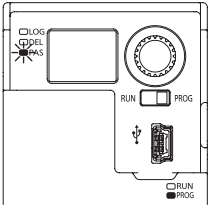
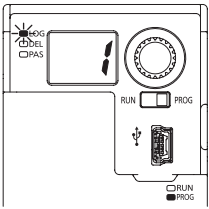
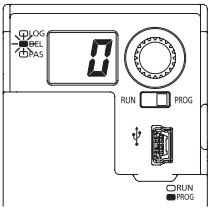
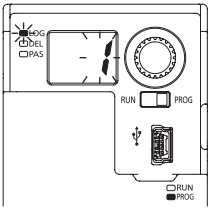
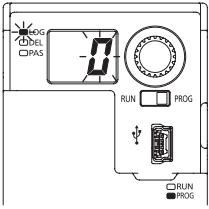
Step	Status of indicators and switches	Description
12		Rotating the rotary switch blinks the password selection indicator (orange). Rotate the rotary switch further to return to Step 11.
13		Transition to "Select operation setting." The logic No. currently set is displayed in the 7-segment indicator (red). Logic selection indicator (orange) blinks. "1: Overall stop control" is set at factory. Rotating the rotary switch proceeds to Step 14. Pressing the rotary switch proceeds to Step 15. Holding down the rotary switch proceeds to Step 21.
14		The currently set No. for OFF delay time is displayed in the 7-segment indicator (red). Delay selection indicator (orange) blinks. "0: 0 sec." is set at factory. Rotating the rotary switch returns to Step 13. Pressing the rotary switch proceeds to Step 18. Holding down the rotary switch proceeds to Step 21.
15		Transition to "Set logic." The logic No. currently set is displayed in the 7-segment indicator (red) and blinks. Rotate the rotary switch to select Logic No. from "1" to "0".
16		Logic No. 0 is customizable logic. To use customizable logic, this device must be connected to a PC to make settings by a software tool. Refer to "Chapter 5 Software Tool." If Logic No. 0 is selected, "Set OFF delay time" cannot be selected. OFF delay time for Logic No. 0 is changed with a software tool.

Setting of Logics and OFF Delay Time

Step	Status of indicators and switches	Description
17		<p>As an example, “1” is selected.</p> <p>Press the rotary switch for the determination and return to Step 13. Holding down the rotary switch determines the selection and then returns to Step 21.</p>
18		<p>Transition to “Set OFF delay time.”</p> <p>The current No. for OFF delay time is displayed in the 7-segment indicator (red) and blinks.</p>
19		<p>Rotate the rotary switch to select OFF delay time from “0” to “9”.</p>
20		<p>As an example, “0” is selected.</p> <p>Press the rotary switch for the determination and return to Step 14. Holding down the rotary switch determines the selection and then returns to Step 21.</p>
21		<p>Transition to “Confirm operation setting.”</p> <p>Logic No. is displayed in the the 7-segment indicator (red).</p> <p>Rotate the rotary switch.</p>

Setting of Logics and OFF Delay Time

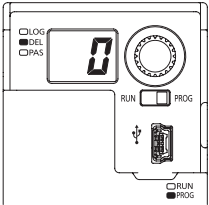
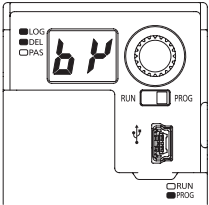
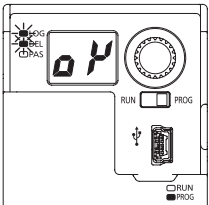
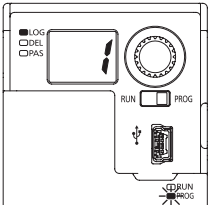
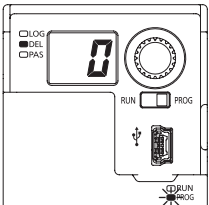
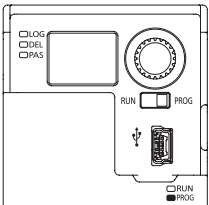
Step	Status of indicators and switches	Description
22		<p>The No. for OFF delay time is displayed in the 7-segment indicator (red).</p> <ul style="list-style-type: none"> When the selected logic and OFF delay time are confirmed, hold down the rotary switch to proceed to Step 24. If either or both of the logic or OFF delay time differ from those selected, rotate the rotary switch.
23		<p>In the 7-segment indicator (red), "bP" indicating "Back" is displayed. The logic selection indicator (orange) and delay selection indicator (orange) light up.</p> <p>Pressing the rotary switch returns to Step 13. Select logic and OFF delay time again.</p>
24		<p>Holding down the rotary switch changes the display to that shown in the illustration at left.</p> <p>In the 7-segment indicator (red), "oP" indicating "OK" is displayed. The logic selection indicator (orange) and delay selection indicator (orange) blink.</p> <p>Transition to "Write / confirm operation setting." The logic and OFF delay time set in this device have been changed.</p> <p>Releasing the hand from the rotary switch proceeds to the next step.</p>
25		<p>After the end of write operation, logic No. and No. for OFF delay time are alternately displayed in the 7-segment indicator (red).</p> <p>A logic No. is shown in the illustration at left.</p> <p>Logic selection indicator (orange) lights up.</p> <p>As an example, "1" is selected.</p>
26		<p>No. for OFF delay time is shown in the illustration at left.</p> <p>Delay selection indicator (orange) lights up.</p> <p>As an example, "0" is selected.</p> <p>After confirming operation setting, press the rotary switch.</p>
27		<p>Transition to "Quit setting mode."</p>

Setting of Logics and OFF Delay Time

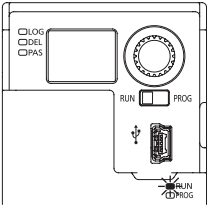
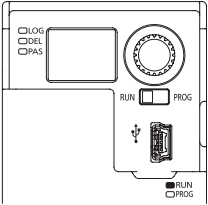
Step	Status of indicators and switches	Description
28		<p>Switch the mode selector switch to the "RUN" side.</p> <p>The operation indicator (green) blinks.</p> <p>Press the rotary switch.</p>
29		<p>The operation indicator (green) status changes to lighting up.</p> <p>This device transitions to "RUN" status.</p>

4-5 Change Password

4-5-1 Flowchart of Change Password

Password is changed according to the flowchart below.

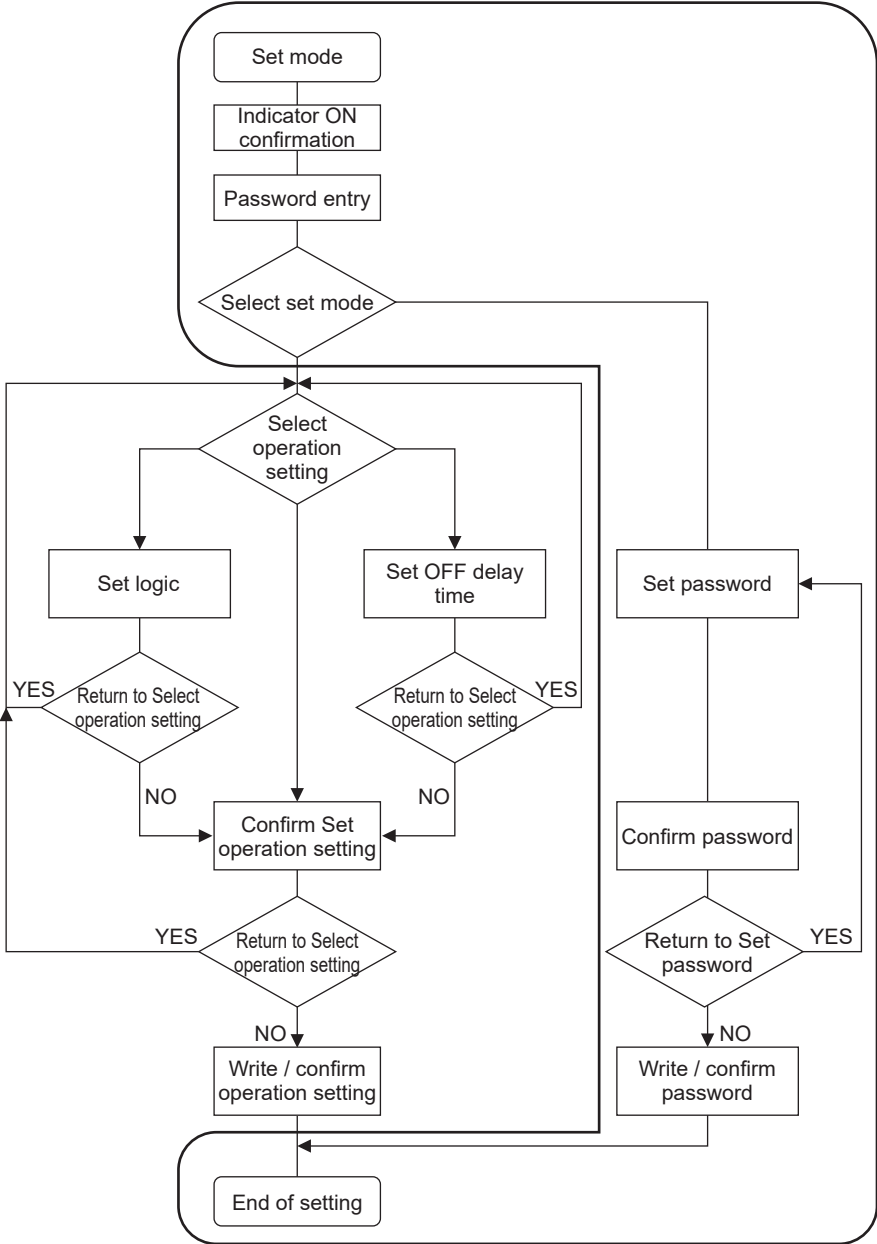

Change Password

4-5-2 Operation Procedure for Change Password

The procedure for changing the password (password 1 / 2) set in this device is described below. To stop changing the password before Step 19 in the table below, turn the mode selector switch to the "RUN" side, and the operation for change password will be canceled. After Step 20 or later, the operation cannot be canceled.

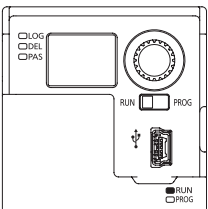
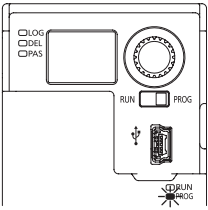
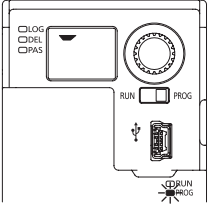
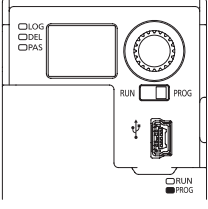
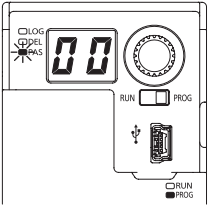
Step	Status of indicators and switches	Description
1		<p>Mode selector switch: RUN side Operation indicator (green): Lights up</p> <p>The power saving function of this device turns OFF the 7-segment indicator (red) 3 sec. after power ON, the end of initial diagnosis, or final operation.</p>
2		<p>Switch the mode selector switch to the "PROG" side. This device transitions to "PROG mode."</p> <p>The operation indicator (green) turns OFF. The setting indicator (orange) blinks.</p>
3		<p>This device automatically transitions to "Indicator ON confirmation."</p> <p>Individual segments of the 7-segment indicator (red) light up one by one.</p> <p>Check for an error code displayed in the 7-segment indicator (red).</p> <p>Press the rotary switch.</p>
4		<p>The setting indicator (orange) status changes from blinking to lighting up. This device transitions to "PROG mode."</p> <p>Press the rotary switch.</p>
5		<p>Transition to "Enter password."</p> <p>Password selection indicator (orange) blinks. Password 1 "00" is displayed in the the 7-segment indicator (red).</p> <p>Select password 1 and password 2. At factory, password 1 is set to "00", password 2, "00".</p>

Change Password

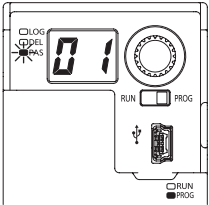
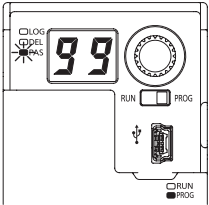
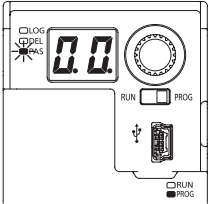
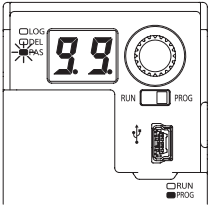
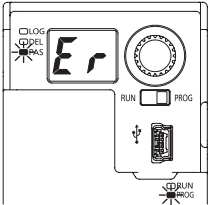
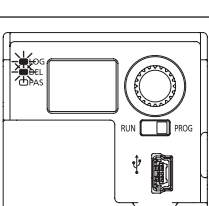
Step	Status of indicators and switches	Description
6		<p>Select password 1. Select a number by rotating the rotary switch.</p>
7		<p>Select password 1 from "00" to "99". Determine password 1 by pressing the rotary switch.</p>
8		<p>Password 2 "00" is displayed in the the 7-segment indicator (red). Select password 2. Similarly, select a number by rotating the rotary switch.</p>
9		<p>Select password 2 from "00" to "99". Determine password 2 by pressing the rotary switch.</p> <p>When password 1 and password 2 are correct, proceed to Step 11. When password 1 or 2 is incorrect, proceed to Step 10.</p>
10		<p>"Er" is displayed in the 7-segment indicator (red). Pressing the rotary switch returns to Step 5. Enter the password again.</p>
11		<p>Transition to "Select setting mode."</p> <p>Password selection indicator (orange) turns OFF. The logic selection indicator (orange) and delay selection indicator (orange) blink.</p>

Change Password

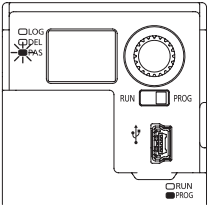
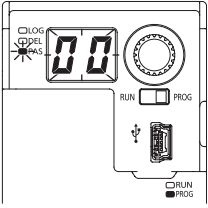
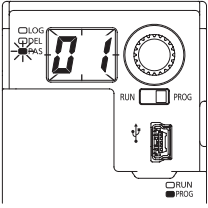
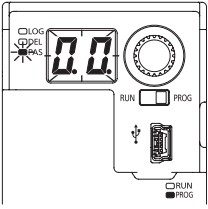
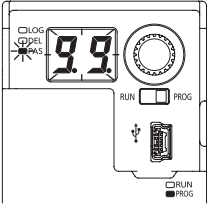
Step	Status of indicators and switches	Description
12		<p>Rotating the rotary switch blinks the password selection indicator (orange).</p> <p>Press the rotary switch.</p>
13		<p>Transition to "Set password."</p> <p>Password 1 "00" is displayed in the the 7-segment indicator (red).</p>
14		<p>Set password 1.</p> <p>Select a number by rotating the rotary switch.</p> <p>Select password 1 from "00" to "99".</p> <p>As an example, select "01" for password 1 and then determine it by pressing the rotary switch.</p>
15		<p>Password 2 "00" is displayed in the the 7-segment indicator (red).</p> <p>Set password 2.</p> <p>Similarly, select a number by rotating the rotary switch.</p>
16		<p>Select password 2 from "00" to "99".</p> <p>As an example, select "99" for password 2 and then determine it by pressing the rotary switch.</p>

Change Password

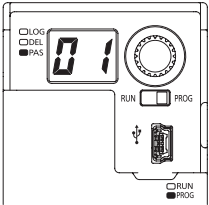
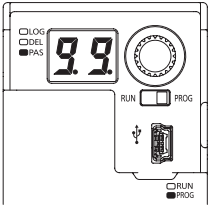
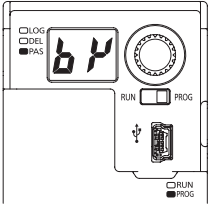
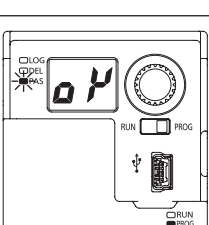
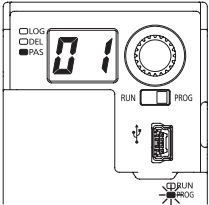
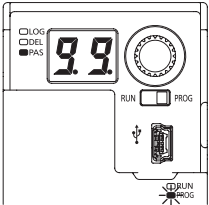
Step	Status of indicators and switches	Description
17		<p>Transition to "Confirm password."</p> <p>Display password 1. Rotate the rotary switch.</p>
18		<p>Display password 2.</p> <p>When the selected password is correct, hold down the rotary switch to proceed to Step 20. If the selected password is incorrect, rotate the rotary switch.</p>
19		<p>In the 7-segment indicator (red), "bP" indicating "Back" is displayed.</p> <p>Pressing the rotary switch returns to Step 13. Set passwords 1 and 2 again.</p>
20		<p>Holding down the rotary switch changes the display to that shown in the illustration at left.</p> <p>In the 7-segment indicator (red), "oP" indicating "OK" is displayed. Password selection indicator (orange) blinks.</p> <p>Transition to "Write / confirm password." The passwords of this device have been changed.</p> <p>Releasing the hand from the rotary switch proceeds to the next step.</p>
21		<p>After the end of write operation, password 1 and password 2 are alternately displayed in the 7-segment indicator (red). Password 1 is shown in the illustration at left.</p> <p>As an example, "01" is shown.</p>
22		<p>Password 2 is shown in the illustration at left.</p> <p>As an example, "99" is shown.</p> <p>After confirming password 1 and password 2, press the rotary switch.</p>

Change Password

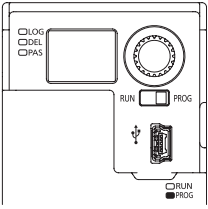
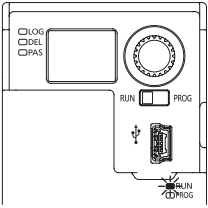
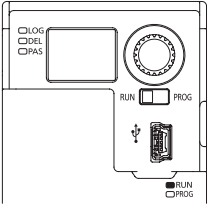
Step	Status of indicators and switches	Description
23		Transition to "Quit setting mode."
24		<p>Switch the mode selector switch to the "RUN" side.</p> <p>The operation indicator (green) blinks.</p> <p>Press the rotary switch.</p>
25		<p>The operation indicator (green) status changes to lighting up.</p> <p>This device transitions to "RUN" status.</p>

CAUTION

Connections to this device via USB are assumed to include temporary connections for e.g., settings and diagnoses. Constant connections via USB are not allowed.

<Reference>

The available functions vary depending on the version of **SF-C21** software and software tool “**Configurator SF-C**.”
For details, refer to “**2-4-1 Version-related Information**.”

5-1 System Configuration

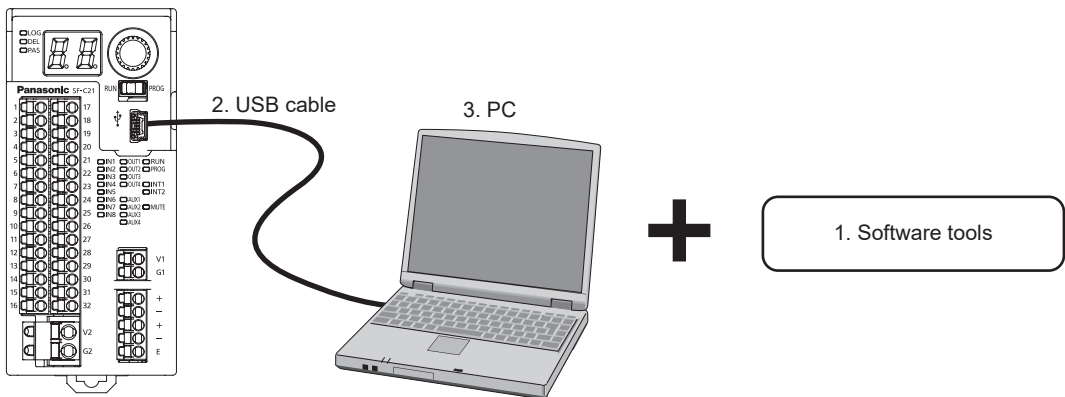

1. Software tool “Configurator SF-C”

Exclusive for this device.

It is used for logic settings, diagnoses, and preparation of documents.

The software tool is downloadable at our website.

URL: <https://industry.panasonic.com/global/en/downloads/?tab=software>

In addition to “Narrow down by Part No. / Model No. format”, use “**SF-C21**” for searching.

2. USB cable

Use a USB cable available in the market.

Type of cable	Length
USB 2.0 cable (A: miniB)	3m or less



(On the side of PC)

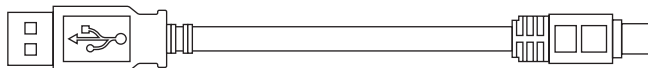

USB A type (male)– USB miniB type (5 pin, male)

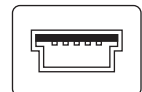

(On the side of this device)

5-2 System requirements

Compatible OS	Windows®11 (64 bit) Windows®10 (32 bit, 64 bit)
CPU	2 GHz or better
RAM	4 GB or more (Windows®11 64 bit) 4 GB or more (Windows®10 64 bit) 2 GB or more (Windows®10 32 bit)
SSD/HDD	2 GB or more of free space

- Users must be members of the “Administrators” or “Power Users” group to log in.
- USB port is required.

5-3 Installation

Double-click downloaded “ConfiguratorSF-C_v****”.

Install the program according to the instruction of the installation program.

If a warning message for Windows, e.g., “User account control” or “Publisher of the driver software cannot be verified”, may be displayed before the completion of installation, such a message does not cause any problem. Proceed to the next step.

Installing the USB driver is completed automatically when this device is connected to the PC.

* Download and install .NET Framework (4.6.2 or later) from Microsoft website as necessary.

5-4 Uninstallation

Uninstall “Configurator SF-C”.

Select “Start” → “Control Panel” → “Program and Features”, and then uninstall them.

5-5 Connection of this Device and a PC

5-5-1 Connection to “Monitor Mode”

To recognize this device by connecting it to a PC, perform the following procedure:

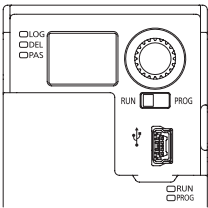
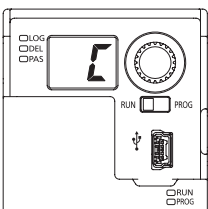
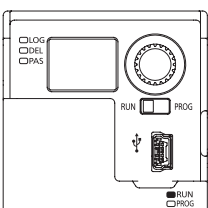
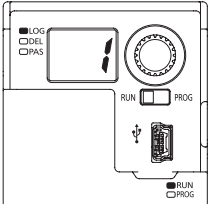
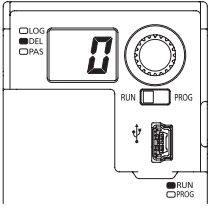
Step	Status of indicators and switches	Description
1		<p>Power: OFF Mode selector switch: RUN side</p> <p>With the internal power supply and external power supply turned OFF, connect this device with a PC via the USB cable.</p>
2		<p>Turn ON the power supply.</p> <p>“L” is displayed in the 7-segment indicator (red). All the other indicators turn OFF.</p> <p>*: If an error message, for example, “Your USB device is not recognized,” is displayed in the PC, plug and unplug the USB connector, or turn ON the power supply again. This prevents displaying the message.</p> <p>Press the rotary switch.</p> <p>*: If the connection is made for the first time, press the rotary switch after the completion of USB driver installation.</p>
3		<p>The device enters “Monitor mode.”</p> <p>The operation indicator (green) lights up.</p> <p>In “Monitor mode,” the software tool is used to read data from and monitor this device. “Monitor mode” prevents writing data into this device. When writing data into this device, refer to Procedure “5-5-2 Connection to “Transfer Mode””.</p>
4		<p>Press the rotary switch.</p> <p>The logic No. currently set is displayed in the 7-segment indicator (red). Logic selection indicator (orange) lights up.</p> <p>“f: Overall stop control” is set at factory.</p>
5		<p>Rotate the rotary switch.</p> <p>The currently set No. for OFF delay time is displayed in the 7-segment indicator (red). Delay selection indicator (orange) lights up.</p> <p>“0: 0 sec.” is set at factory.</p> <p>Rotating the rotary switch returns to No. 1.</p>

The procedure above is enabled either before or after the activation of the software tool that is described in the next section.

Connection of this Device and a PC

5-5-2 Connection to “Transfer Mode”

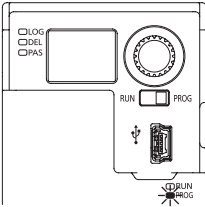
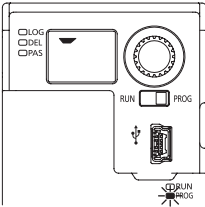
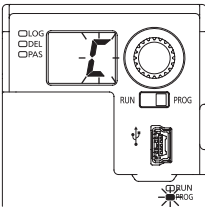
Step	Status of indicators and switches	Description
1		<p>When this device is put in “Monitor mode,” turn the mode selector switch to the “PROG” side.</p> <p>The operation indicator (green) turns OFF. The setting indicator (orange) blinks.</p>
2		<p>This device automatically transitions to “Indicator ON confirmation.”</p> <p>Individual segments of the 7-segment indicator (red) light up one by one.</p> <p>Check for an error code displayed in the 7-segment indicator (red).</p> <p>Press the rotary switch.</p>
3		<p>The device enters “Transfer mode.”</p> <p>“Transfer mode” disables setting operation on the side of this device. The software tool is used, for example, to transfer customizable logic to this device and change password.</p> <p>“Transfer mode” puts all control outputs in OFF status.</p>

5-5-3 Setting to “Monitor Mode” after the End of Transfer

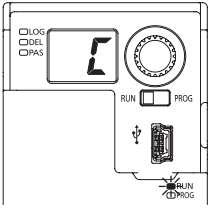
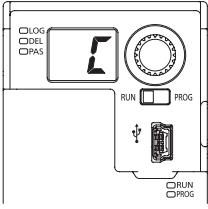
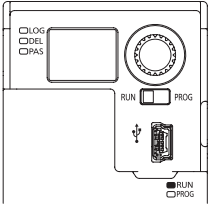
Step	Status of indicators and switches	Description
1		<p>When this device is put in “Transfer mode,” turn the mode selector switch to the “RUN” side.</p> <p>The operation indicator (green) blinks.</p> <p>Press the rotary switch.</p>
2		<p>“L” is displayed in the 7-segment indicator (red). All the other indicators turn OFF.</p> <p>Press the rotary switch.</p>
3		<p>The device enters “Monitor mode.”</p> <p>The operation indicator (green) lights up.</p> <p>In “Monitor mode,” the software tool is used to read data from and monitor this device.</p> <p>“Monitor mode” prevents writing data into this device.</p> <p>When writing data into this device again, refer to Procedure “5-5-2 Connection to “Transfer Mode””.</p>

5-5-4 Disconnection of this Device from a PC

When the USB cable is unplugged from this device, it can be disconnected from the PC. The USB cable can be unplugged except when “logic is being transferred” by the software tool. When the mode selector switch is turned to the “RUN” side after the USB cable is unplugged, pressing the rotary switch has this device perform normal operation.

5-5-5 Initialization of this Device

Unplugging the USB cable during writing operation displays “**ED**” in the 7-segment indicator (red), putting it in the lockout status. When “**ED**” is displayed, connect this device to the PC again and initialize it by referring to “5-22-1-2 Initialize Settings”.

Startup and End of Software Tool

5-6 Startup and End of Software Tool

5-6-1 Startup Software Tool

Startup the software tool “**Configurator SF-C**” according to the procedure below.

Step 1 Click the “Start” button in Windows.

Step 2 From All Programs, go to “Panasonic Industry Safety” and “Configurator SF-C” in order, and then select Configurator SF-C.

Step 3 Starting up the software tool “**Configurator SF-C**” displays the main menu and selection menu.

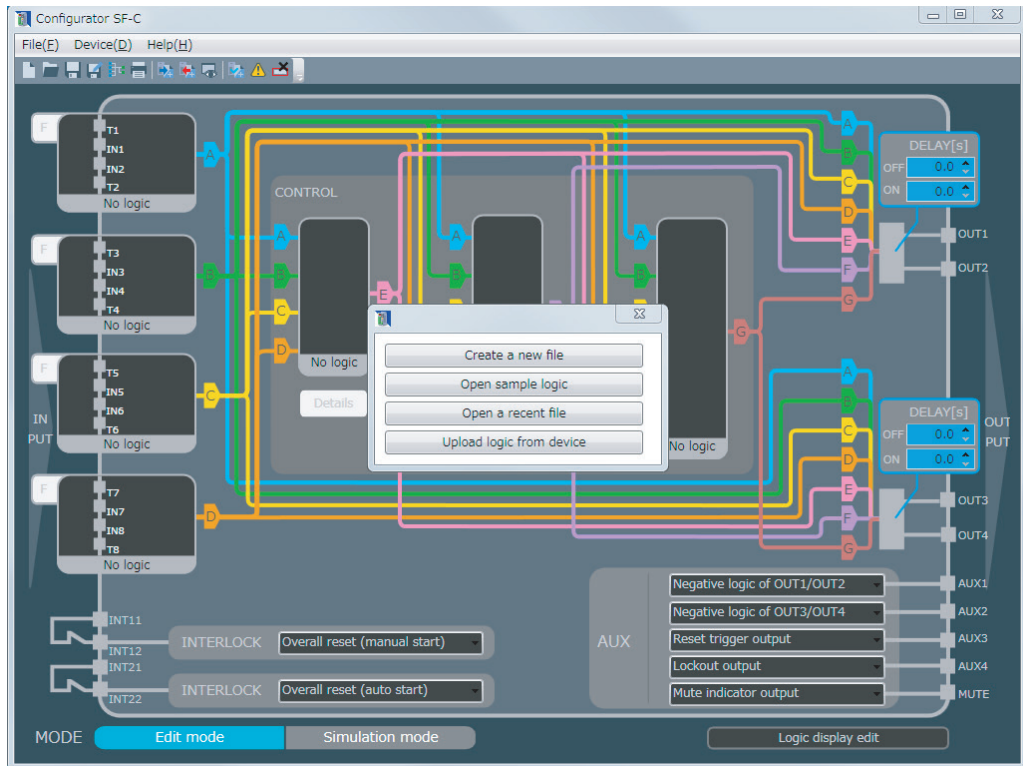

From the selection menu, select one of the following four operations:

- Create a new file
- Open sample logic
- Open a recent file
- Upload logic from device

■ To Create a new file

Pressing “**Create a new file**” has the selection menu disappear, making the main screen clear. Free logics can be created.

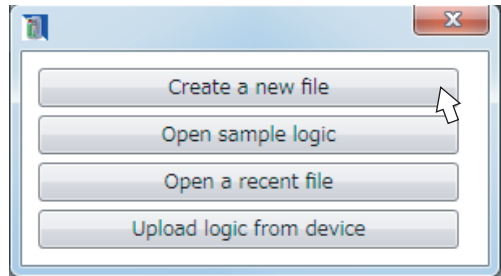

■ To Open sample logic

Pressing “**Open sample logic**” displays the “Open sample logic” screen. Eight preset logics provided to this device can be used as sample logics.

Select one from preset logics No.1 to No.8. Sample logics are revised to create logics.

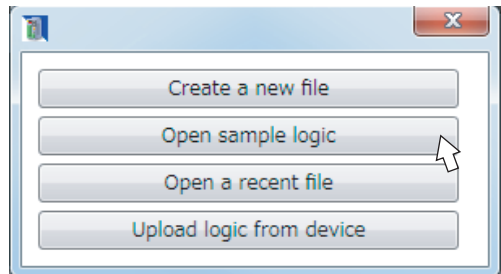

■ To Open files saved

Pressing “**Open a recent file**” displays the “Open file” screen. Select a file to be opened.

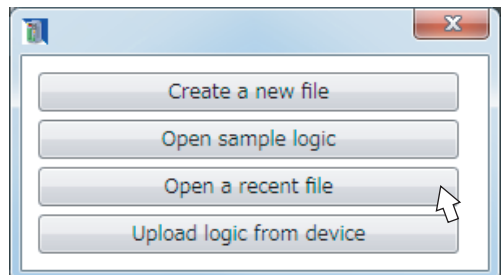

■ To obtain a logic from this device in connection

Pressing “**Upload logic from device**” starts communication with this device, acquiring a logic.

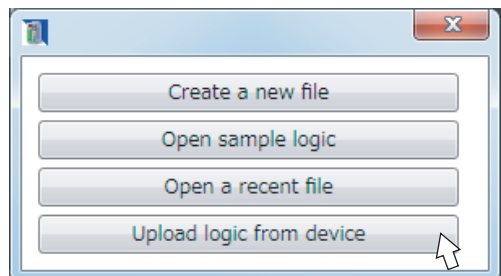

Startup and End of Software Tool

5-6-2 End of Software Tool

To exit the software tool, follow one of the methods below.

<Method 1>

From the menu bar, select “**File (F)**” and then “**Exit (X)**”.

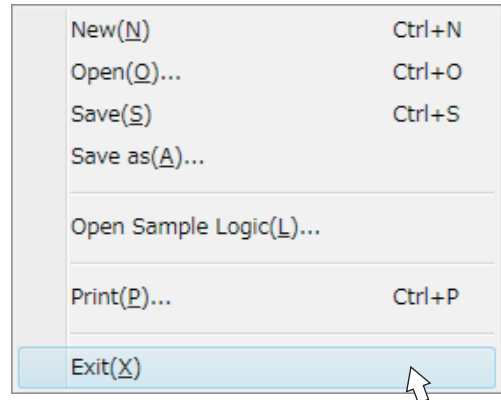

<Method 2>

Click  at the upper right corner of the screen.

5-7 New / Save / Print of a File

5-7-1 Create New File

New files are created by using one of the following methods.

<Method 1>

When the software tool starts up, select **“Create a new file”**.

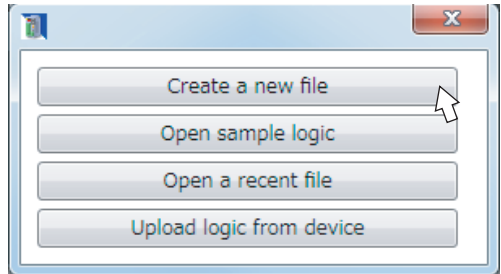

<Method 2>

From the menu bar, select **“File (F)”** and then **“New (N)”**.

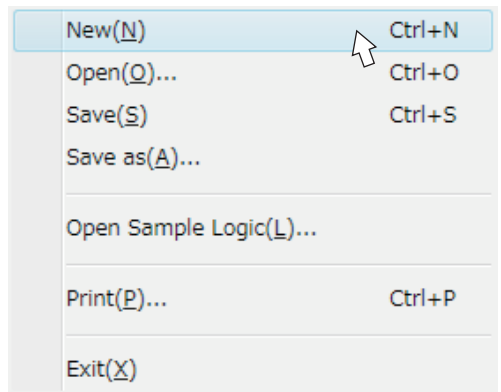

<Method 3>

Click **“New”** icon on the toolbar.

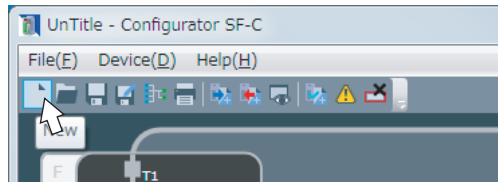

New / Save / Print of a File

When a new file is created according to one of the methods, the main screen is made clear.

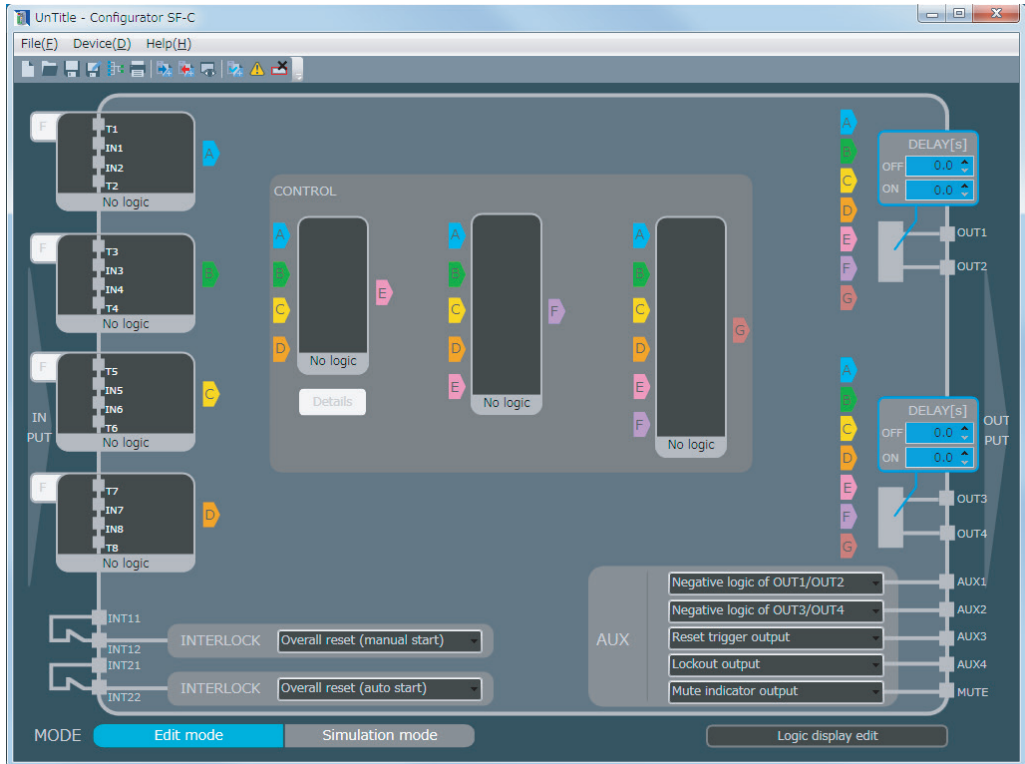

5-7-2 Open Sample Logic

Open sample logic is performed according to one of the following methods.

<Method 1>

When the software tool starts up, select “**Open sample logic**”.

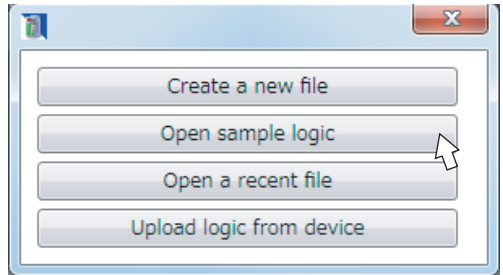

<Method 2>

From the menu bar, select “**File (F)**” and then “**Open sample logic (L)**”.

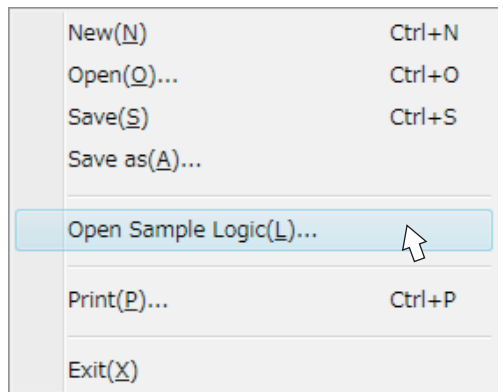

<Method 3>

Click the “**Open sample logic**” icon on the tool-bar.

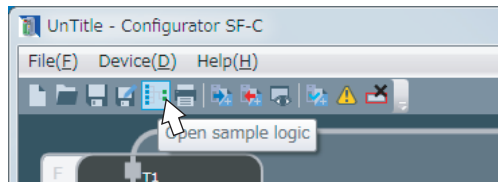

New / Save / Print of a File

When “Open sample logic” is displayed, select a logic with the “Previous” and “Next” button, and then press “OK”.

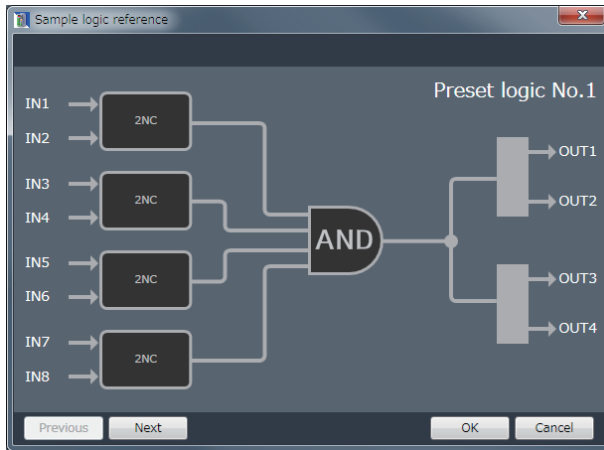

The logic is displayed in the main screen.

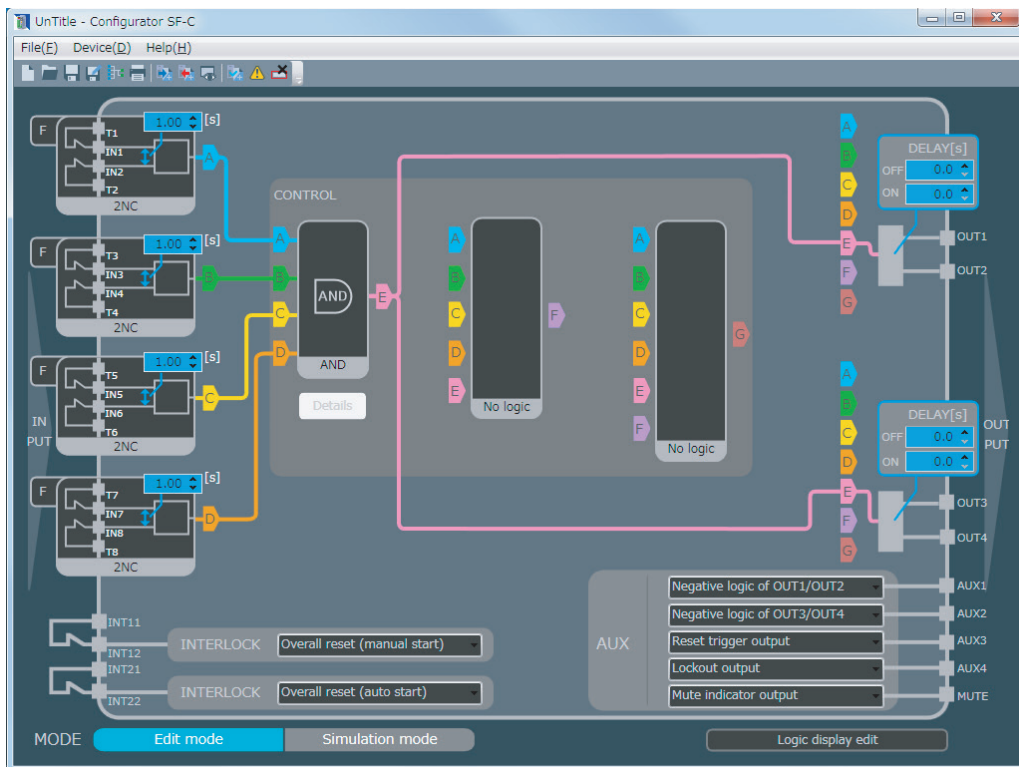

5-7-3 Open a Recent File

Existing files are opened by using one of the following methods.

<Method 1>

When the software tool starts up, select “**Open a recent file**”.

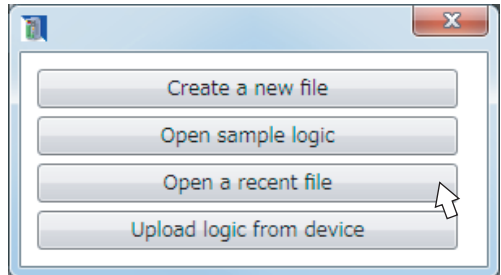

<Method 2>

From the menu bar, select “**File (F)**” and then “**Open (O)**”.

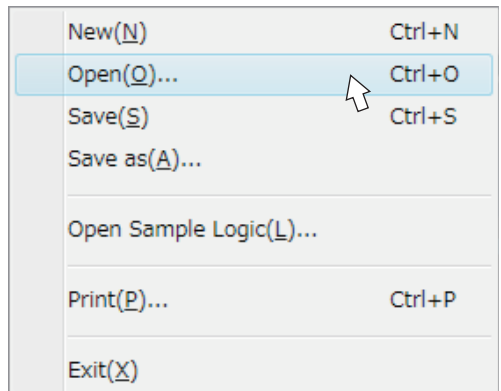

<Method 3>

Click “**Open**” icon on the toolbar.

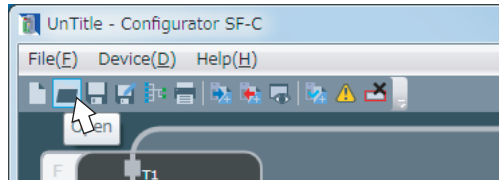

New / Save / Print of a File

When the file selection diagram is displayed, select a file and click **“Open (O)”**.

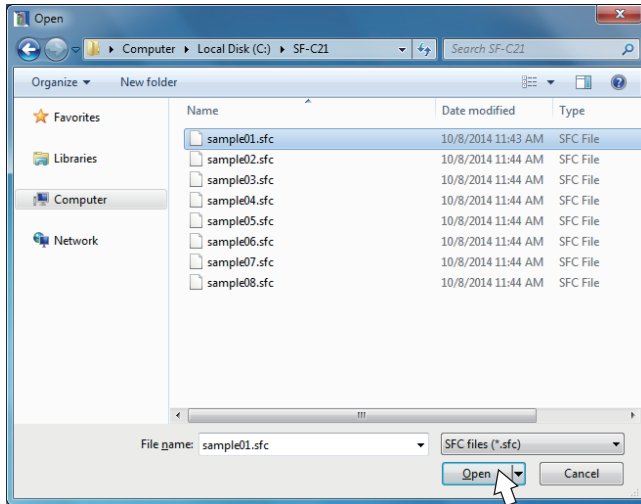

Opening the file displays a logic in the main screen.

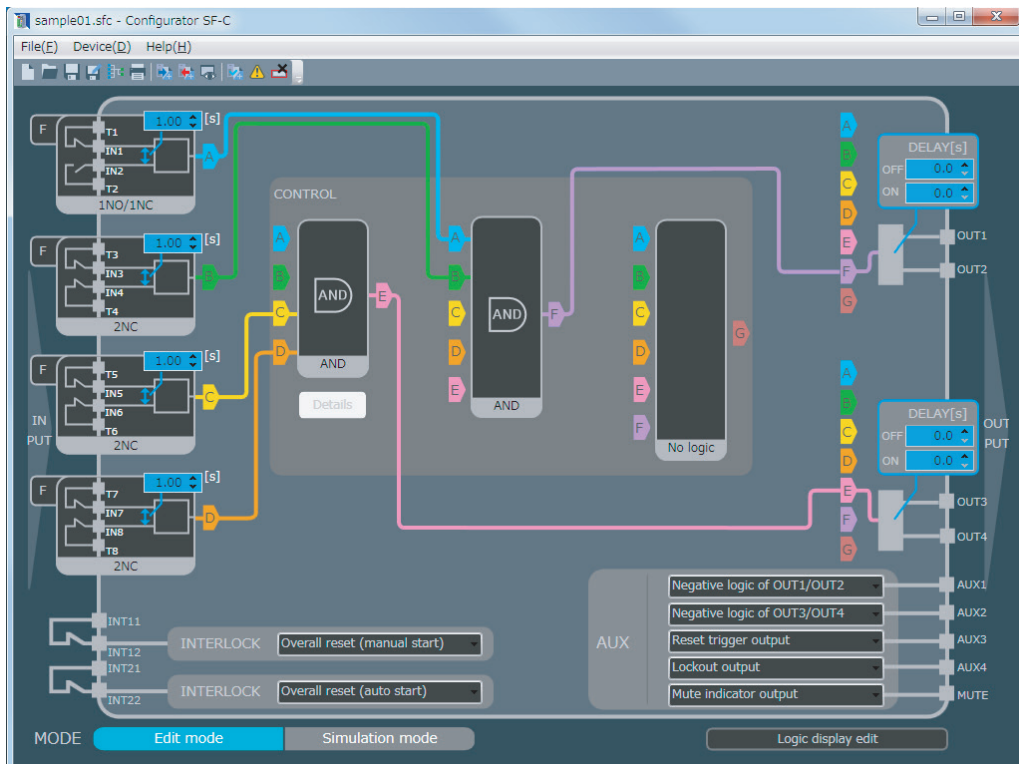

5-7-4 Upload Logic from this Device

To obtain logics from this device, one of the following methods is performed.

Connect this device with a PC according to procedure “5-5-1 Connection to “Monitor Mode””.

<Method 1>

When the software tool starts up, select “**Upload logic from device**”.

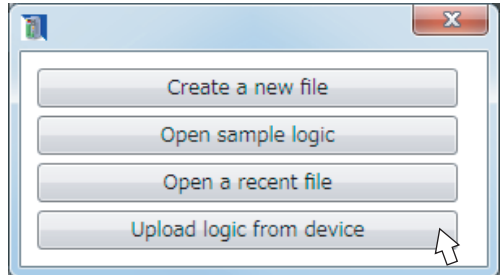

<Method 2>

From the menu bar, select “**Device (D)**” and then “**Upload logic from device (U)**”.

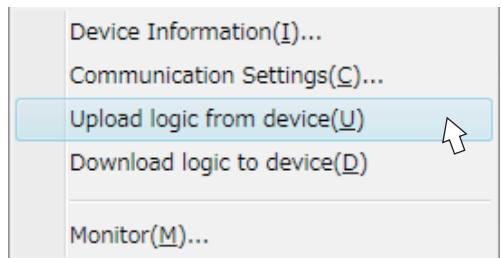

<Method 3>

Click the “**Upload logic from device**” icon on the toolbar.

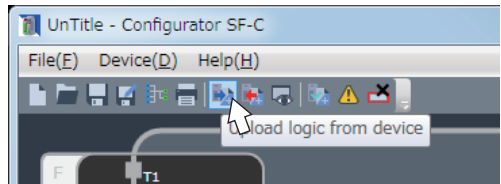

New / Save / Print of a File

5-7-5 Saving a File

Save a logic, to be displayed in the main screen, in the PC as a file.
The file format of the files to be created is specified to be file name “.sfc”.

Select “Save” to save a file to the same file, and select “Save as” to save under a new file name.

■ Save

Files are saved by one of the following methods:

<Method 1>

From the menu bar, select “**File (F)**” and then “**Save (S)**”.

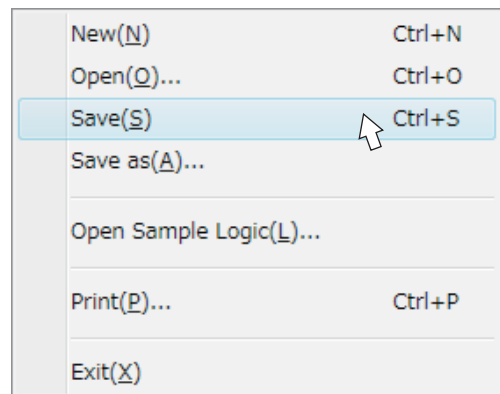

<Method 2>

Click the “**Save**” icon on the toolbar.

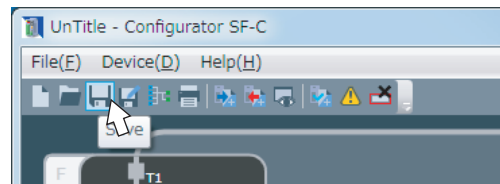

■ Save as

Files are saved under new file names by one of the following methods:

<Method 1>

From the menu bar, select **"File (F)"** and then **"Save as (A)"**.

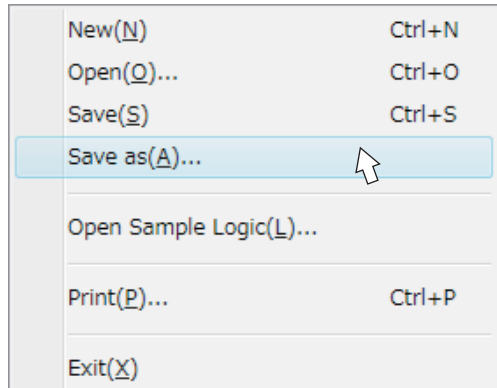

<Method 2>

Click the **"Save as"** icon on the toolbar.

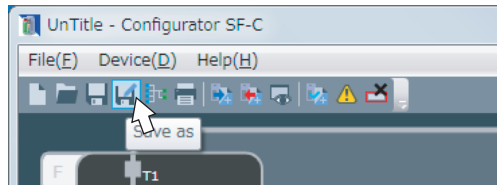

Specify a place to save the file and the file name, and click **"Save (S)"**.

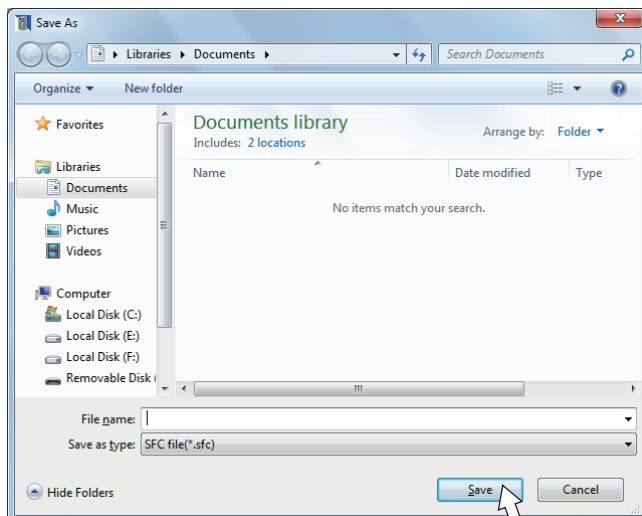

5-7-6 Download Logic to Device

Logic is transferred to this device according to the following procedure:

Connect this device to the PC according to the procedures “5-5-1 Connection to “Monitor Mode”” and “5-5-2 Connection to “Transfer Mode””.

Step 1

<Method 1>

From the menu bar, select “**Device (D)**” and then “**Download logic to device (D)**”.

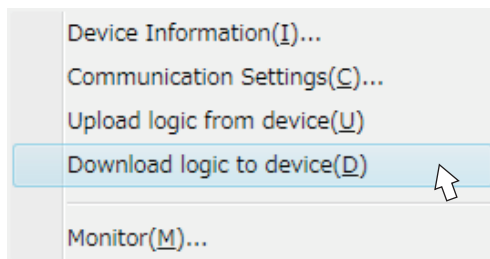

<Method 2>

Click the “**Download logic to device**” icon on the toolbar.

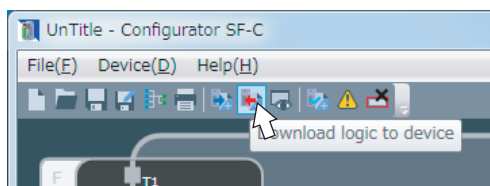

Step 2 Diagnosing logic

Diagnose the logic created.

This shows a display without error.

Click “**OK**” and proceed to the next step.

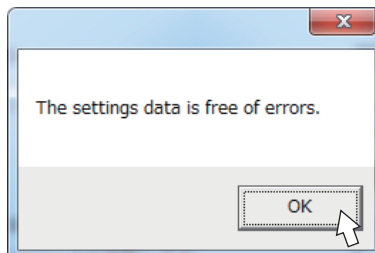

This shows a display with some error in the logic created.

Click “**OK**” to return to the main screen, and then correct the logic.

The place of an error is highlighted in a red frame in the main screen.

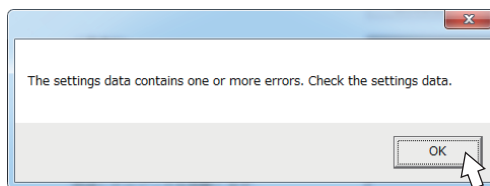

Step 3 Completion of entry and transfer of password

Enter the password and click "OK".

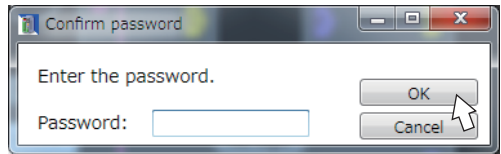

Logic is being transferred.
While being transferred, do not remove the USB cable, or do not turn OFF the power supply.

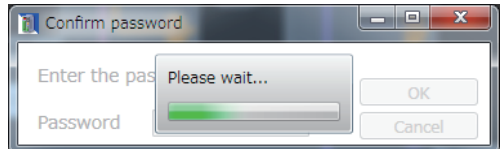

The file has been downloaded.
Click "OK".

According to the procedures "5-5-3 Setting to "Monitor Mode" after the End of Transfer" and "5-5-4 Disconnection of this Device from a PC", return this device to the monitor mode and remove the USB cable.

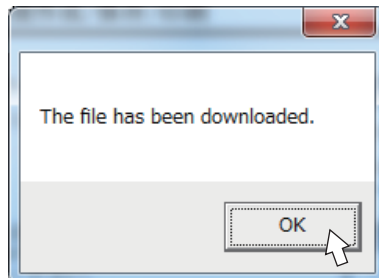

New / Save / Print of a File

5-7-7 Print

Logic is printed by one of the following methods:

<Method 1>

From the menu bar, select “**File (F)**” and then “**Print (P)**”.

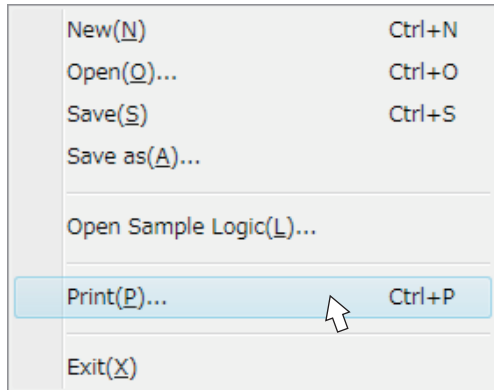

<Method 2>

Click the “**Print**” icon on the toolbar.

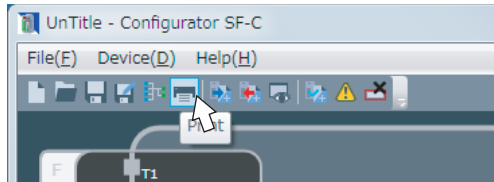

When the print dialog is displayed, select a printer and perform printing.

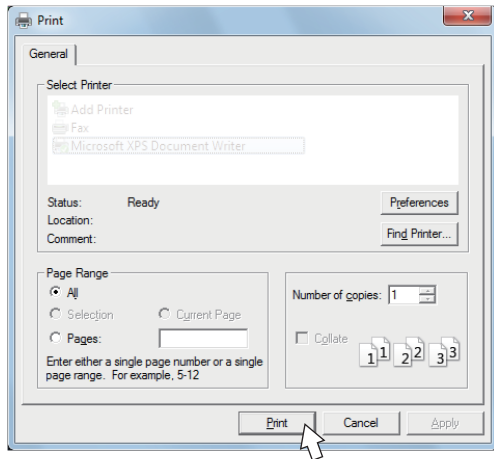

Preview is displayed on the backside of the dialog box. The contents can be confirmed before printing.

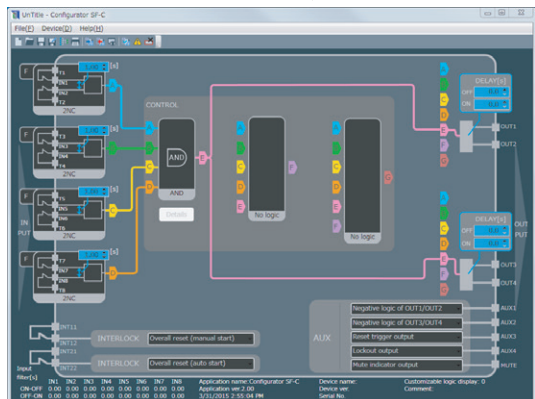

5-8 Each Part Name of the Software Tool and Basic Operation

The main screen of the software tool is comprised of the following elements:

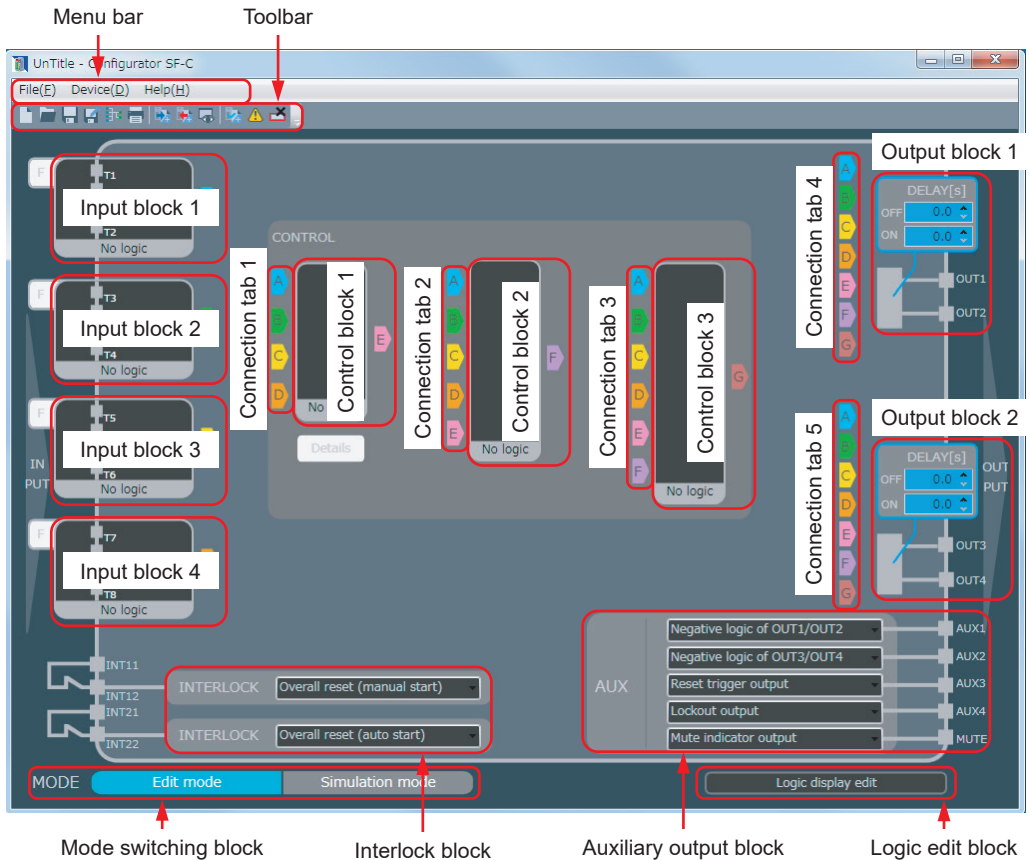

■ Menu bar

All the operations and functions of the software tool are prepared in a menu format according to various applications.

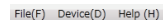

■ Toolbar

Frequently used functions are displayed with icons.



■ Input block

Input devices are selected, and input mismatch time, etc., are set.

Clicking the input block opens "Input select".

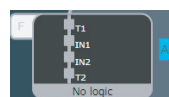

Each Part Name of the Software Tool and Basic Operation

■ Connection tab

Clicking this tab connects a circuit.



■ Output block

ON delay time and OFF delay time for control output are set.



■ Control block 1

Required control is selected from AND, OR, parallel muting control, sequential muting control, two-hand control, and input select.

Selecting parallel muting control or sequential muting control activates detailed settings, allowing required detailed items to be set in muting.



■ Control block 2 / 3

Required logic is selected from AND, OR and no logic.

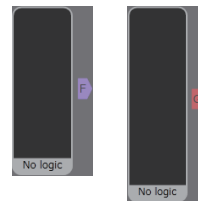

■ Interlock block

Overall reset, partial reset (manual start) and partial reset (auto start) are carried out.

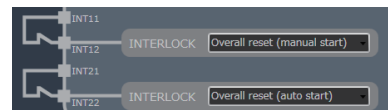

■ Auxiliary output block

Settings of auxiliary output can be changed. The results of the monitoring of input devices, internal logic, etc., are set as auxiliary output.

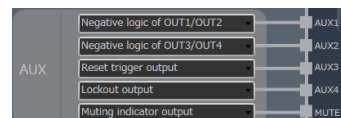

■ Mode switching block

Switching is performed between edit mode and simulation mode.



■ Logic edit block

Display of customizable logic No. is set.

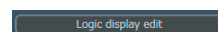

Creating and Editing a Logic, and Saving a File and Transferring it to this Device

5-9 Creating and Editing a Logic, and Saving a File and Transferring it to this Device

5-9-1 Creating and Editing Logic

The following methods are available to create and edit logic.

■ Creating a new logic

A logic is created according to “**5-7-1 Create New File**”.

■ Open and edit a logic according to Open sample logic

Sample logic is opened and edited according to “**5-7-2 Open Sample Logic**”.

When a logic uses “Parallel muting,” “Sequential muting,” “Two-hand control,” and “Input select,” editing an applicable logic by opening it is easier than by creating a new logic.

■ Open a recent file and edit it

When a logic has already been created, open a recent file and edit it according to “**5-7-3 Open a Recent File**”.

■ Obtain a logic from this device and edit it

According to “**5-7-4 Upload Logic from this Device**”, obtain the logic, which is being used in this device, and edit it.

5-9-2 Saving a Logic File and Transferring it to this Device

■ Saving a logic in the PC

After a logic is created and edited, it is saved in the PC as a file according to “**5-7-5 Saving a File**”.

■ Transfer a logic to this device

After a logic is created and edited, it is transferred to this device according to “**5-7-6 Download Logic to Device**”.

Create a Logic

5-10 Create a Logic

5-10-1 Create a Logic

As an example, sample logic No.1 is created from the new screen.

5-10-1-1 Set Input Lock

Click input block 1 and open “Input select”.
Click “2NC” at the upper left portion.

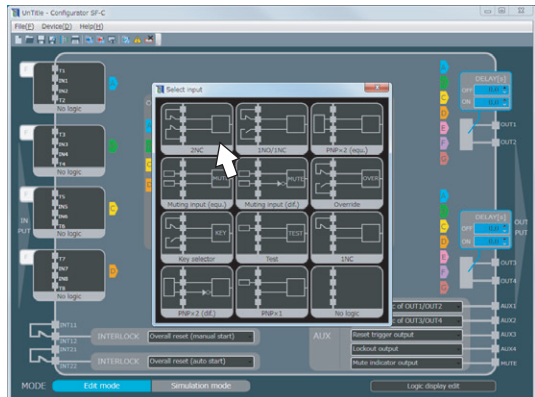

Selected “2NC” is set in input block 1.

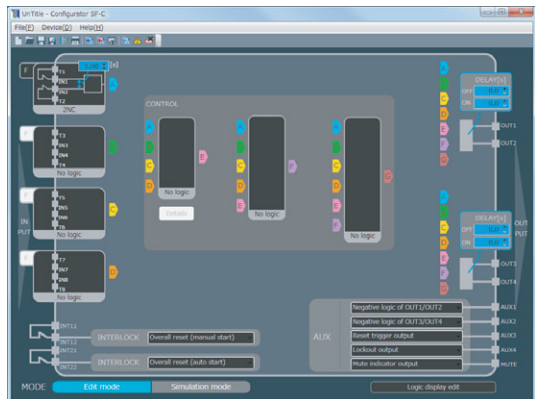

Similarly set input blocks 2, 3 and 4.
Set all input blocks to “2NC”.

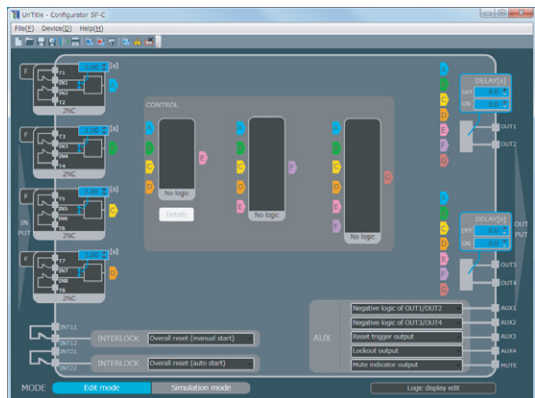

5-10-1-2 Set Control Block 1

Click control block 1 and open “Select control”.
Click “AND” at the upper left portion.

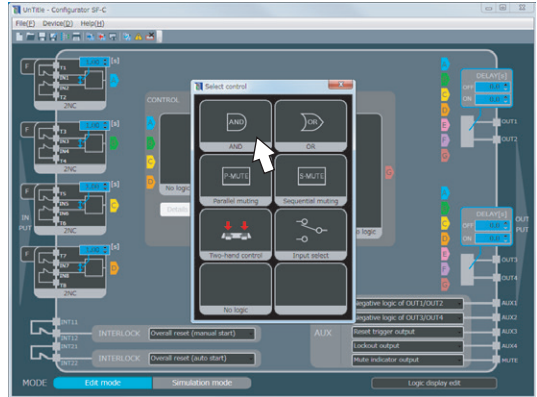

Selected “AND” is set in control block 1.

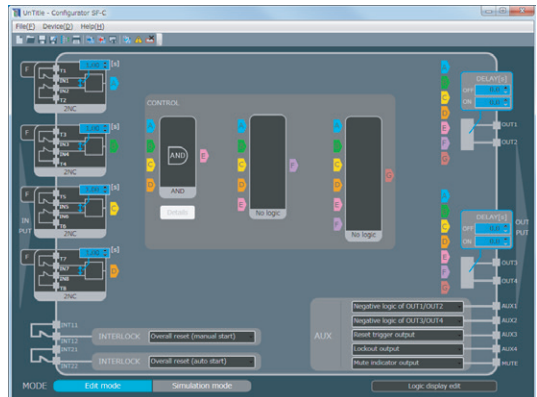

5-10-1-3 Create a Circuit

Click “A” of connection tab 1 to connect it to A of input block 1.

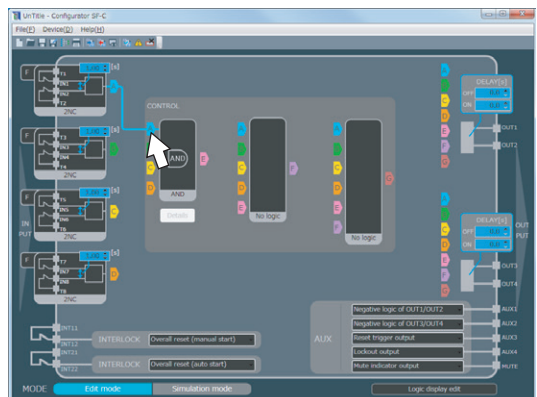

Create a Logic

Similarly click **"B"** of connection tab 1 to connect it to B of input block 2. Click **"C"** to connect it to C of input block 3. Click **"D"** to connect it to D of input block 4.

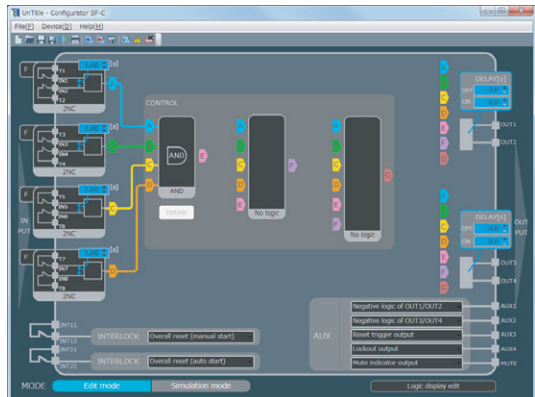

Click **"E"** of connection tab 4 to connect it to E of connection tab 1.

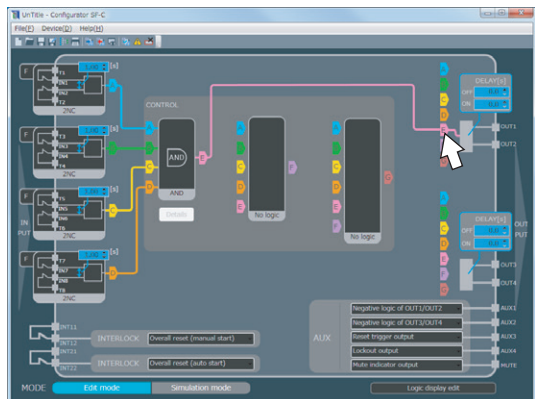

Click **"E"** of connection tab 5 to connect it to E of connection tab 1.
Sample logic No.1 is created completely.

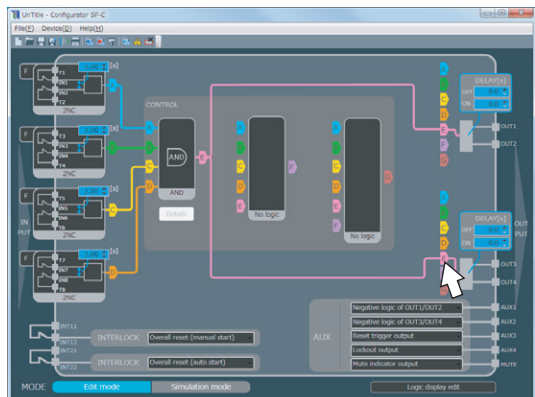

5-10-2 Example of a Logic Using Control Block 1 / 2

Click control block 2 and open “Select control”.
Click “AND”.

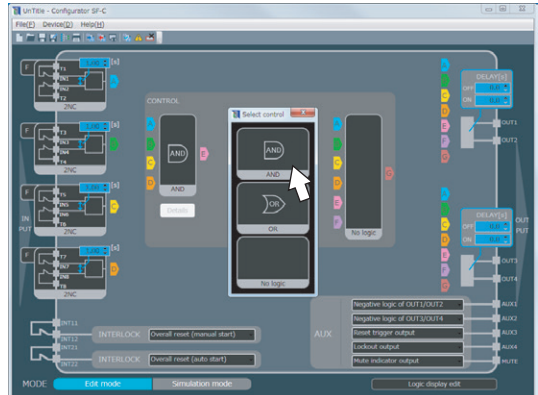

Selected “AND” is set in control block 2.

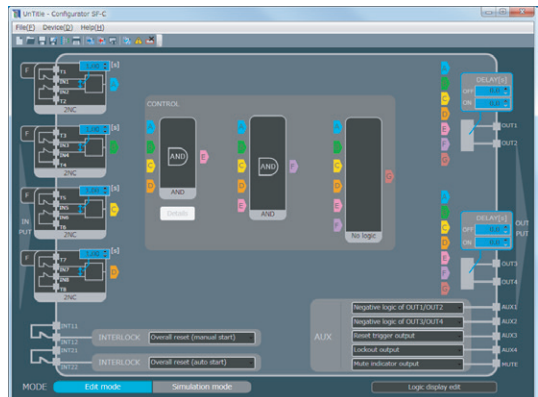

- Click “C” of connection tab 1 to connect it to C of input block 3. Click “D” to connect it to D of input block 4.
- Click “A” of connection tab 2 to connect it to A of input block 1. Click “B” to connect it to B of input block 2.
- Click “F” of connection tab 4 to connect it to F of connection tab 2.
- Click “E” of connection tab 5 to connect it to E of connection tab 1.

The following logic is created.

- Output block 1 outputs the AND of input blocks 1 and 2.
- Output block 2 outputs the AND of input blocks 3 and 4.

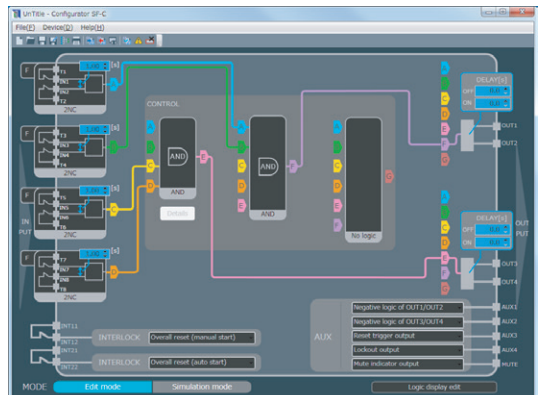

Create a Logic

5-10-3 Example of a Logic Using Control Block 1 / 2 / 3

For the creation of a logic of control block 1/2, refer to “5-10-2 Example of a Logic Using Control Block 1 / 2”.

Click control block 3 and open “Select control”. Click “AND”.

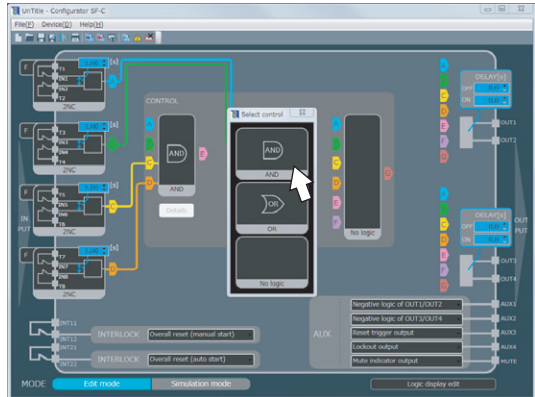

Selected “AND” is set in control block 3.

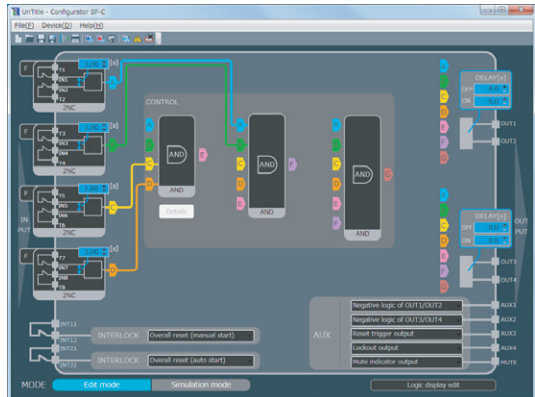

Click the following portions to perform wiring.

- Click “E” of connection tab 3 to connect it to E of connection tab 1. Click “F” to connect it to F of connection tab 2.
- Click “G” of connection tab 4 to connect it to G of connection tab 3.
- Click “E” of connection tab 5 to connect it to E of connection tab 1.

The following logic is created.

- Output block 1 outputs the AND of control blocks 1 and 2.
- Output block 2 outputs the AND of input blocks 3 and 4.

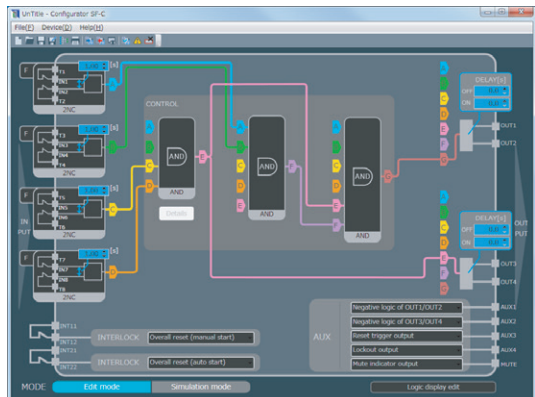

5-11 Select Input

5-11-1 Types of Inputs

■ 2NC

Used to connect the safety device of 2NC contact output.

■ 1NO / 1NC

Used to connect safety device of 1NO / 1NC contact output.

■ PNP×2 (equ.)

Used to connect safety devices (PNP semiconductor output × 2). The safety device to be used is a type that turns “ON-OFF” two outputs simultaneously.

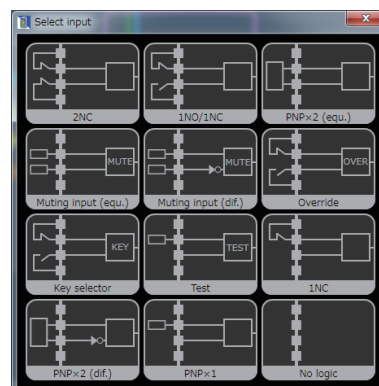

■ Muting input (equ.)

Used as an input of mute sensor when it is selected as “Parallel muting” or “Sequential muting” in control block 1.

This connects two mute sensors (equ.), each of which has two NO contacts or output [PNP semiconductor output].

When “Sequential muting” is set in control block 1, both “Muting input (equ.)” and “Muting input (dif.)” cannot be used at a time.

■ Muting input (dif.)

Used as the input of mute sensor when it is selected as “Parallel muting” or “Sequential muting” in control block 1.

This connects two mute sensors (dif.), each of which has NO and NC contacts or output [PNP semiconductor output].

When “Sequential muting” is set in control block 1, both “Muting input (equ.)” and “Muting input (dif.)” cannot be used at a time.

■ Override

Used as the input of override switch when it is selected as “Parallel muting” or “Sequential muting” in control block 1.

Connects a momentary type switch for 1NO / 1NC contact.

■ Key selector

Used as the input of key selector switch when “Input select” is selected in control block 1.

Connects an alternate type key switch (with a forced breaking contact) for 1NO / 1NC.

■ Test

When test input is effective, the control output is turned into OFF status.

The switch for 1NC contact or PNP semiconductor output (normally set to ON) is connected.

- Contact “Close” or output ON : Test input invalid
- Contact “Open” or output OFF : Test input valid

The input block with this input selected is not connected to connection tab, control block, or output block. If connected, the input block is judged to be erroneous by the software tool.

Input Select

■ 1NC

Used to connect the safety device of 1NC contact output. In this case, the category of the system including this device is specified to be category 2 or less.

■ PNP×2 (dif.)

Used to connect safety devices (PNP semiconductor output × 2). The safety device to be used is a type that turns “ON-OFF” two outputs alternately.

■ PNP×1

Used to connect a safety device (PNP semiconductor output × 1). In this case, the category of the system including this device is specified to be category 2 or less.

■ No logic

If the number of safety devices in connection is less than 4, they are used for unused input block. If a safety device is connected, the operation is not reflected.

<Reference>

For the connectable input blocks, and combinations of them with control blocks, refer to “**5-20 Configuration Check**”.

5-11-2 Setting of Contact Input Mismatch Allowable Time

Setting “2NC” or “1NO / 1NC” in the input block displays a small blue window. Mismatch allowable time is set between two inputs by using up-down arrows in the input block or by direct entry.

	Settable range	Initial setting
Input mismatch allowable time	0 (unlimited) to 60 sec. (in units of 0.01 sec.)	1 sec.

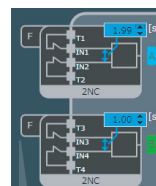

5-11-3 Input Filter Time Setting

Clicking "F" in the input block opens "Input filter time." Input filter time for ON to OFF and OFF to ON is set for the prevention of erratic operations caused by input chattering and noise.

		Settable range	Initial setting
Input filter time	ON - OFF	0 to 1 sec. (in units of 0.01 sec.)	0 sec.
	OFF - ON		

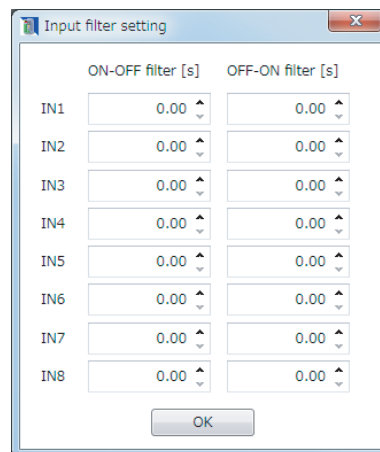

CAUTION

If the input filter time (ON - OFF) is set, the OFF response time for control output becomes "10ms + input filter time (ON - OFF)" or less.

Select Control

5-12 Select Control

Selectable control in control block 1 / 2 / 3

■ AND

“AND” of inputs connected to the control block is output.
Two or more inputs are connected.

The input blocks in which muting input (equ.), muting input (dif.), override, key selector or test has been set cannot be connected.

■ OR

“OR” of inputs connected to the control block is output.

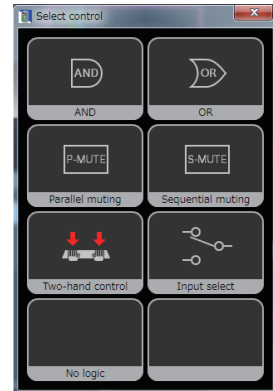

■ No logic

Selected when the control block is unused.

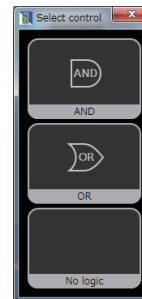

Selectable control only in control block 1

■ Parallel muting

Used when “Parallel muting” is performed.

In the connected muting input block, the IN with the smaller number is set as muting input A, and the IN with the larger number is set as muting input B.

If input block 3 is set and connected as a muting input, IN5 becomes muting input A and IN6 becomes muting input B.

■ Sequential muting

Used when “Sequential muting” is performed.

In the two connected muting input blocks, INs are set as muting input A, muting input B, muting input C and muting input D in the ascending order of the IN number.

If input blocks 2 and 3 are set and connected as muting inputs, IN3 becomes muting input A, IN4 becomes muting input B, IN5 becomes muting input C, and IN6 becomes muting input D.

When “Sequential muting” is selected, both “Muting input (equ.)” and “Muting input (dif.)” cannot be used for input block at a time.

■ Two-hand control

Used to configure Two-hand control devices of ISO 13851 (JIS B9712).

■ Select input

When output, state is switched between the two input blocks.

Three input blocks are connected to control blocks, and one of them is specified to be “key selector”.

If input block 2 and input block 4 are set as inputs to be selected and input block 3 is set and connected to the key selector input, input block 2 is selected when IN5 is OFF and IN6 is ON and input block 4 is selected when IN5 is ON and IN6 is OFF.

<Reference>

For the connectable input blocks, and combinations of them with control blocks, refer to “**5-20 Configuration Check**”.

Interlock Block

5-13 Interlock block

Reset operation of this device is set.

Click and select the interlock block.

The combinations of overall resets and partial resets are unavailable.

- Overall reset
- Partial reset (auto start) + Partial reset (auto start)
- Partial reset (auto start) + Partial reset (manual start)
- Partial reset (manual start) + Partial reset (auto start)
- Partial reset (manual start) + Partial reset (manual start)

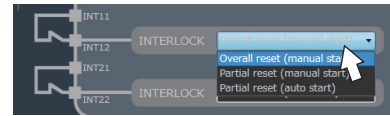

■ Overall reset

The outputs of two systems of this device are reset by one operation.

- Manual reset : Momentary type switch is connected to between INT11 and INT12. Switching the switch contact from “Closed to Open” performs reset operation.
- Auto reset : Short-circuit is generated between INT21 and INT22.

If INT21-INT22 is not short-circuited when power is turned ON, manual reset is automatically selected.

■ Partial reset

Each of the outputs of two systems of this device is reset individually.

- Manual reset : Momentary type switch is connected to between INT11 and INT12 and between INT21 and INT22. Switching the switch contact from “Closed to Open” performs reset operation.
- Auto reset : Short-circuit is generated between INT11 and INT12 and between INT21 and INT22.

Also refer to “3-4 Interlock (Reset)”.

5-14 Auxiliary Output Block

Operations of four auxiliary outputs of this device are set. Click and select the auxiliary output block. "Muting indicator output: MUTE" cannot be changed.

Initial settings are as follows:

AUX1	negative logic output of OUT1 / OUT2
AUX2	Negative logic of OUT3 / OUT4
AUX3	Reset trigger output
AUX4	Lockout output
MUTE	Muting indicator output (fixed)

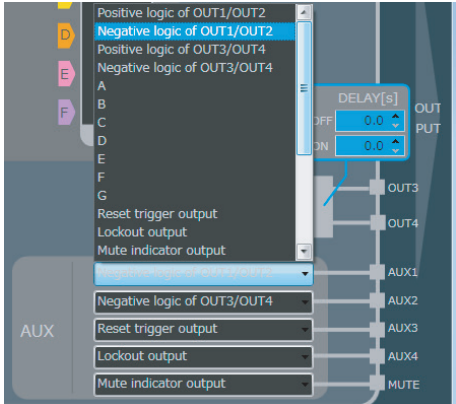

The following operations can be set in auxiliary outputs.

- Positive logic output or negative logic output of OUT1 / OUT2
- Positive logic output or negative logic output of OUT3 / OUT4
- Output A / B / C / D of diagnosis results of input block 1 / 2 / 3 / 4
- Output E / F / G of diagnosis results of internal logical circuit
- Reset trigger output
- Lockout output
- Muting indicator output
- Monitor output of IN1 to 8
- Normally off

Also refer to "3-3 Auxiliary Output".

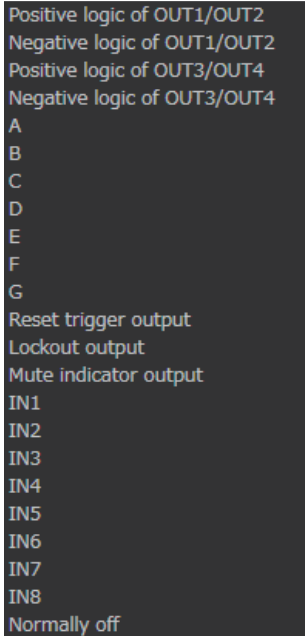

Mode Switching Block

5-15 Mode switching block

5-15-1 Mode Switching

Clicking the mode switching block can switch between “Edit mode” and “Simulation mode.”

5-15-2 Simulation Mode

Click “**Simulation mode**” of the motor switching block.

Logic is diagnosed before transition to Simulation mode.

If an error exists, the message at right is displayed.

Pressing “**OK**” returns to edit mode in the main screen, highlighting the control block and connection tab in red frames.

If no error exists, the message at right is displayed.

Pressing “**OK**” transitions to simulation mode in the main screen.

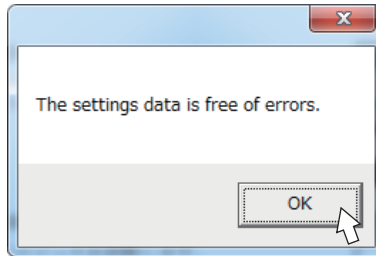
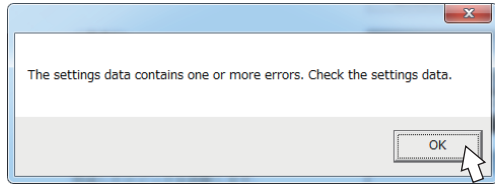
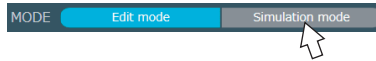

Transition to simulation mode has been performed.

As an example, sample logic No.1 is used.

In the case of overall reset, click the interlock block and select manual reset or auto reset. Automatic reset is automatically selected immediately after transition to simulation mode.

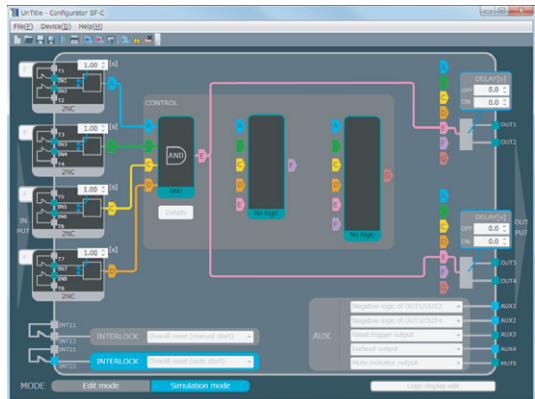

Mode Switching Block

Click “■” of IN1 of input block 1.
It turns light color.
This indicates that the contact is “closed.”

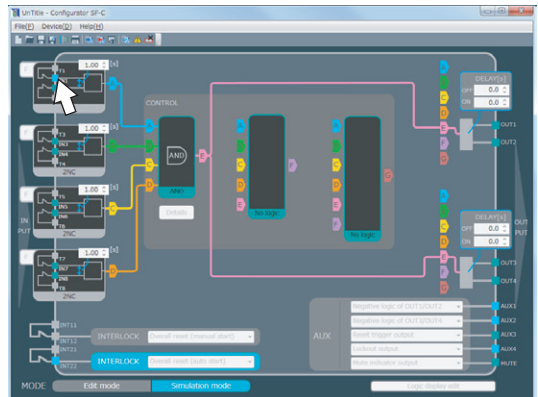

In all input blocks, click “■”.
In OUT1 to OUT4, “■” turns light color.
This indicates that the output is in ON status.

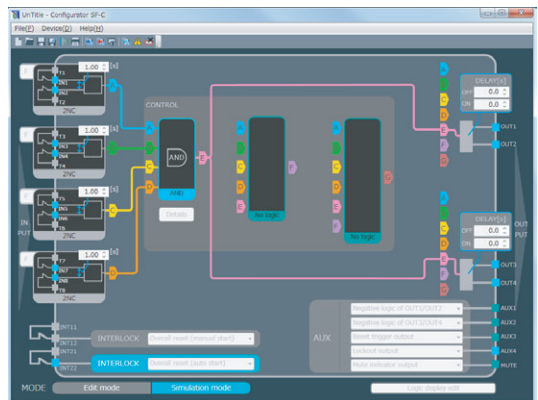

Click “Edit mode” of the mode switching block to terminate simulation mode.



Transition to edit mode.

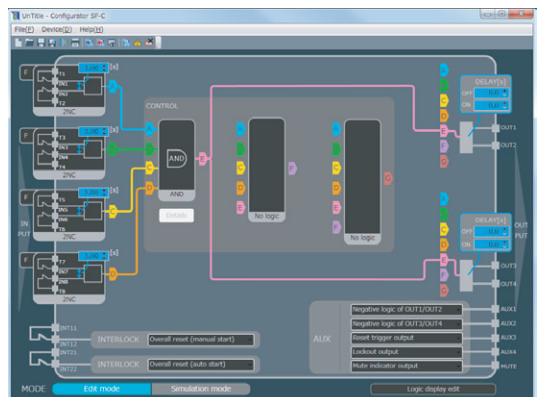

Output, OFF Delay / ON Delay, Muting

5-16 Output Setting, OFF Delay and ON Delay Setting

OFF delay time and ON delay time for control output are set.

OFF delay time and ON delay time can be set by using up-down arrows of the output block or by direct entry.

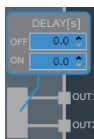

	Setting range	Initial setting
OFF delay time	0 to 60 sec. (In units of 0.1 sec.)	0 sec.
ON delay time	0 to 5,940 sec (In units of 0.1 sec.)	0 sec.

5-17 Detailed Settings (Muting)

“Detailed Settings” is active by setting “Parallel muting” or “Sequential muting” in control block 1.

Clicking “Details” opens “Detailed settings.”

“Allowable time difference in muting input,” “Duration,” “Exit-only muting time” (Note), and “Input priority” for muting and “Duration” for override are set.

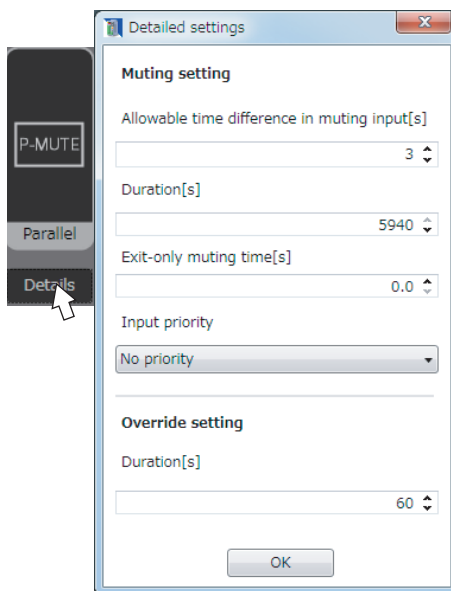

		Setting range	Initial setting
Allowable time difference in muting input	Parallel muting	1 to 10 sec. (in units of 1 sec.)	3 sec.
	Sequential muting	0 (Unlimited) to 288,000 sec. (in units of 1 sec.)	288,000 sec.
Muting duration		0 (Unlimited) to 5,940 sec. (In units of 1 sec.)	5,940 sec.
Exit-only muting time (Note)		1 to 4 sec. (in units of 0.1 sec.)	0 sec.
Muting input condition		No priority / A priority / B (D) priority	No priority
Override duration		1 to 600 sec. (In units of 1 sec.)	60 sec.

Note: This setting is only for parallel muting.

5-18 Logic Display Edit

Clicking “**Logic display edit**” in the logic edit block opens “Logic display edit screen.”

The customizable logic No. displayed on the 7-segment display of the device can be set.

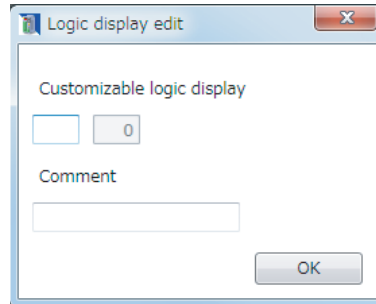

5-19 Verify Files on the Device and PC

Logic created in the main screen is compared with the customizable logic of this device. If a difference exists, the target input block, control block and connection tab are highlighted in white frames.

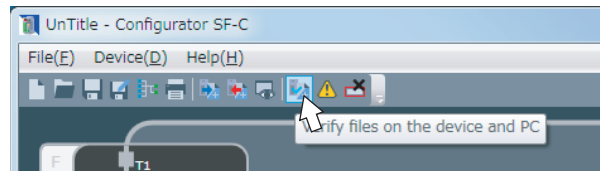

Configuration Check

5-20 Configuration Check

A logic created in the main screen is checked. If an error exists on a dangerous side, the target input block, control block and connection tab are highlighted in red frames.

Only the faults that lead to danger are determined as errors.

Combinations of input blocks and control block 1

◎: Mandatory ○: Connectable ×: Not connectable		Control block 1					
		AND	OR	P-MUTE	S-MUTE	Two-hand control	Select input
Number of input connections		2 to 4	2 to 4	2 or 3	3 or 4	2	3
Input block	2NC	○	○	×	×	○	○
	1NO/1NC	○	○	×	×	○	○
	PNP×2 (equ.)	○	○	◎ ^{Note 1}	◎ ^{Note 1}	○	○
	PNP×2 (dif.)	○	○	◎ ^{Note 1}	◎ ^{Note 1}	○	○
	Muting input (equ.)	×	×	◎ ^{Note 2}	◎ ^{Note 3}	×	×
	Muting input (dif.)	×	×	◎ ^{Note 2}	◎ ^{Note 3}	×	×
	Override	×	×	○	○	×	×
	Key selector	×	×	×	×	×	◎
	PNP×1	○	○	×	×	×	○
	1NC	○	○	×	×	×	○
	Test	×	×	×	×	×	×
	No logic	○	○	×	×	×	○

Notes: 1) For either PNP×2 (equ.) or PNP×2 (dif.), only one connection is allowed.

2) For either Muting input (equ.) or Muting input (dif.), only one connection is allowed.

3) For either Muting input (equ.) or Muting input (dif.), two connections are allowed.

Combinations of input blocks and control block 2 / 3, and connection tab E / F

○: Connectable ×: Not connectable		Control block 2		Control block 3	
		AND	OR	AND	OR
Number of input connections		2 to 4	2 to 4	2 to 4	2 to 4
Input block	2NC	○	○	○	○
	1NO/1NC	○	○	○	○
	PNP×2 (equ.)	○	○	○	○
	PNP×2 (dif.)	○	○	○	○
	Muting input (equ.)	×	×	×	×
	Muting input (dif.)	×	×	×	×
	Override	×	×	×	×
	Key selector	×	×	×	×
	PNP×1	○	○	○	○
	1NC	○	○	○	○
	Test	×	×	×	×
	No logic	○	○	○	○
Connection tab E		○	○	○	○
Connection tab F		×	×	○	○

5-21 Highlighting OFF

Highlighting by “5-19 Verify Files on the Device and PC” or “5-20 Configuration Check” is off.

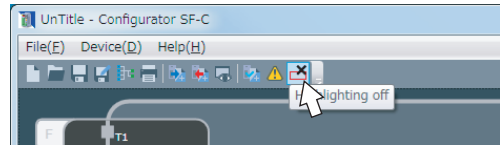

5-22 Device Information

For this device,

- Change password,
 - Initialization of settings,
 - Configuration log check, and
 - Error log
- can be performed.

From the menu bar, select “**Device (D)**” and then “**Device information (I)**”.

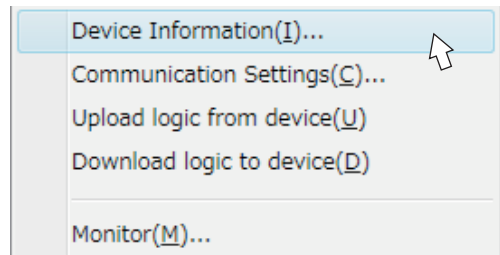

5-22-1 General

Clicking “**General**” tab displays device name, device Ver., serial No. and current logic No. Password change and initialization of settings can be performed.

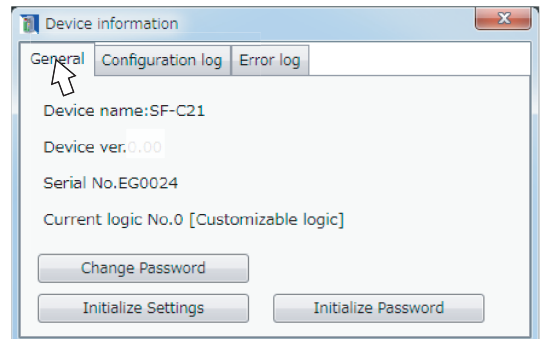

5-22-1-1 Change Password

Clicking “**Change password**” displays “Change password.”

After the password is entered, clicking “**OK**” changes the password to new one.

If the password is wrong, the message “The password is not correct.” displayed. In response to it, enter the correct password again.

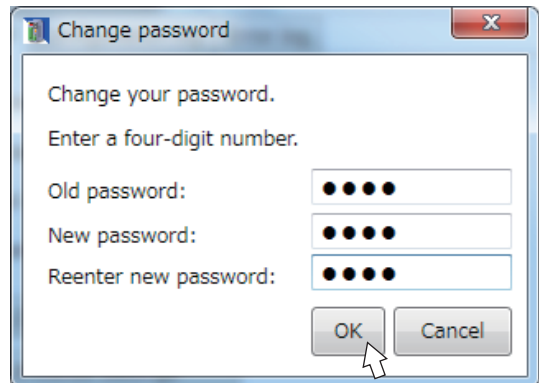

Device Information

5-22-1-2 Initialize Settings

To return settings of this device to the factory settings or when error No. “E” is displayed, initialize this device according to the following procedure. The passwords (Password 1 “” and Password 2 “”) are also initialized.

- Step 1 Connect this device in <Transfer mode> according to <5-5-1 Connection to “Monitor Mode”> or <5-5-2 Connection to “Transfer Mode”>.
- Step 2 From the menu bar, select “Device (D)” and then “Device information (I)” to open “Device information.”
- Step 3 Click the General tab “Initialize Settings”.
- Step 4 When “Confirm password” opens, enter the password.
- Step 5 Clicking “OK” performs initialization.

5-22-1-3 Initialize Password

Clicking “Initialize password” displays “Initialize Password” on the screen.

Enter the initialization code and initialize the password setting in the device.

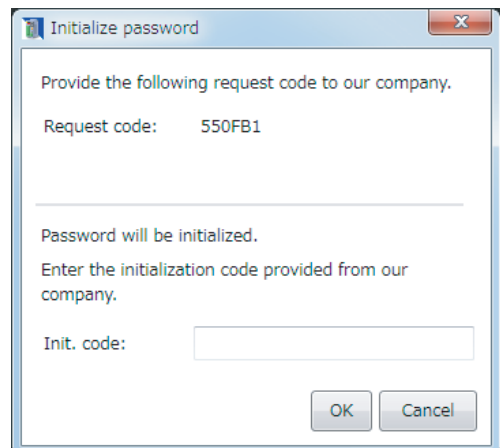

5-22-2 Configuration Log

Clicking “**Configuration log**” confirms logics transferred.
 Five pieces information, including the latest one, can be confirmed.

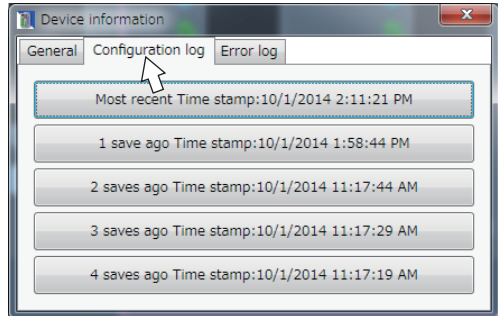

Clicking the bar of a log to be confirmed opens a different screen, allowing you to confirm the logic.

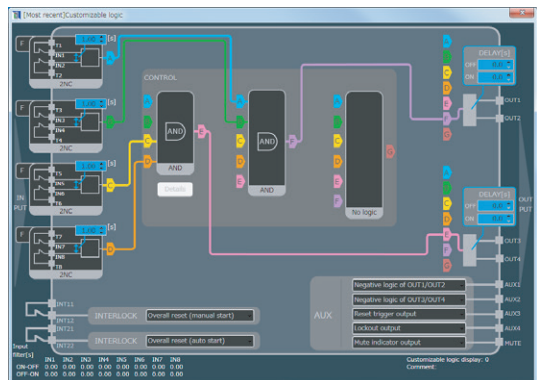

5-22-3 Error Log

Clicking “**Error log**” confirms logs of errors that occurred in the past.
 The past 5 logs can be confirmed.

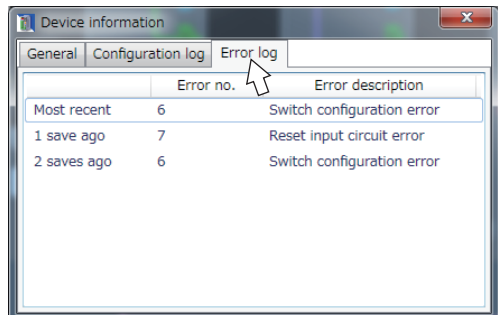

Communication Settings

5-23 Communication Settings

The communication settings of this device are made.

From the menu bar, select “**Device (D)**” and then “**Communication settings (C)**”.

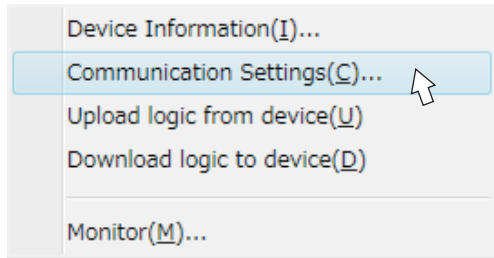

Baud rate, parity bit, stop bit, and addresses can be set.

For details on communication settings, refer to “**3-8 MODBUS Communication (Non-safety)**”.

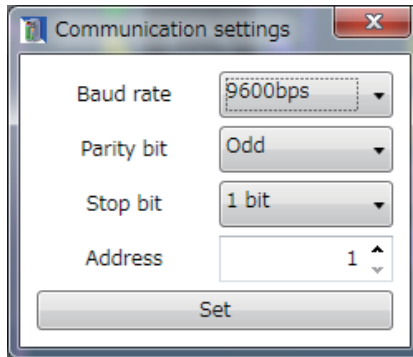

5-24 Monitor

The current status of this device can be monitored.

The monitoring operation is performed by one of the following methods:

<Method 1>

From the menu bar, select “**File (F)**” and then “**Monitor (M)**”.

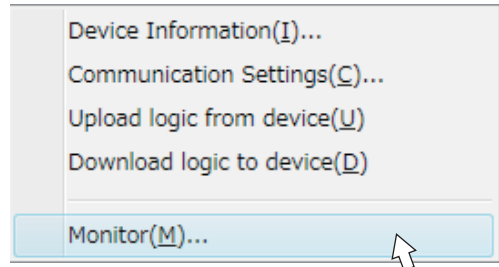

<Method 2>

Click the “**Monitor**” icon on the toolbar.

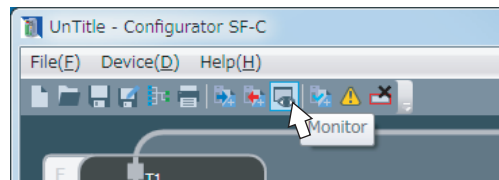

The monitor screen opens.

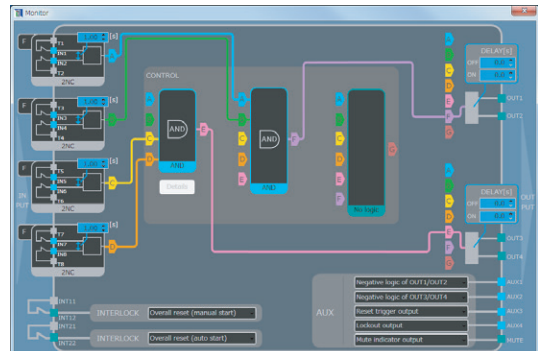

Help

5-25 Help

In Help menu,

- Language setting of software tool (Japanese / English / Chinese / Spanish / French / Italian / Portuguese),
- Display of manual, and
- Confirmation of version of the software tool can be performed.

5-25-1 Language

From the menu bar, select “**Help (H)**” and then select “**Language (L)**”.

Select a language in which the software tool is displayed.

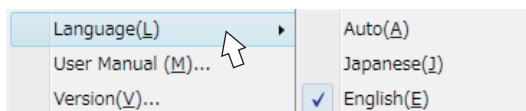

If the language is changed, the software must be restarted. The logic, which is being used for operation and has not yet been saved, should be saved according to the dialog.

5-25-2 Manual

From the menu bar, select “**Help (H)**” and then select “**User Manual (M)**”.

The manual written in the language currently selected is displayed.

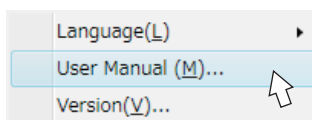

5-25-3 Version Information

From the menu bar, select “**Help (H)**” and then select “**Version (V)**”.

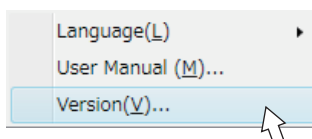

Version information of the software tool is displayed.

Version information →

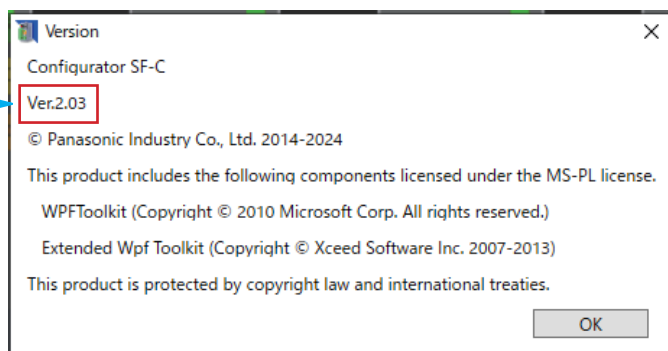

<Reference>

In the event of an error, refer to “**Chapter 7 Troubleshooting**” and notify the authorized engineer of the contents.

If the problem cannot be resolved internally, contact our office.

Please make a copy of this checklist, check each inspection item in the respective square, and file the list for record.

6-1 Daily Inspection

 **WARNING**

Be sure to confirm that the following items prior to operation and confirm that there is no error. Operating this device without inspection or in an error condition can result in death or serious injury.

Inspection item table (daily inspection)

Check column	Inspection item
<input type="checkbox"/>	There is no defect, fold, or damage in the wiring.
<input type="checkbox"/>	The terminal blocks are free from dirt or foreign matter deposited on them.
<input type="checkbox"/>	The corresponding connectors have been connected securely.
<input type="checkbox"/>	The unit is securely installed to the DIN rail or securely mounted by means of machine screws.

6-2 Periodic Inspection (Every Six Months)

 **WARNING**

Be sure to inspect the following items every six months and confirm that there is no error. Operating this device without inspection or in an error condition can result in death or serious injury.

Inspection item table (periodical inspection)

Check column	Inspection item
<input type="checkbox"/>	The structure of the machine does not obstruct any safety mechanism for stopping operation.
<input type="checkbox"/>	No modification has been made in the machine controls which obstructs the safety mechanisms.
<input type="checkbox"/>	The output of this device is correctly detected.
<input type="checkbox"/>	The wiring from this device is correct.
<input type="checkbox"/>	The actual number of operation cycle (time) of the limited lifetime parts (relay, etc.) is less than their rated operation cycles (time).
<input type="checkbox"/>	No screws or connectors of this device are loose.

Maintenance

6-3 Inspection after Maintenance of this Device

Check all of the inspection items given in “**6-1 Daily Inspection**” and “**6-2 Periodic Inspection (Every Six Months)**” when the status of this device is as described below.

- 1) When changes are made to the settings of the device.
- 2) When any parts of this device are replaced.
- 3) When some abnormality is felt during operation.
- 4) When the device installation place or environment is changed.
- 5) When the wiring method or wiring layout is changed.
- 6) When a component or components of a FSD (Final Switching Device) to which the control output is connected are replaced.
- 7) When FSD (Final Switching Device) setting is changed.

<Reference>

- Check the wiring.
- Check the power supply voltage and the power supply capacity.

<All indicators are OFF>

Cause	Remedy
Power is not being supplied.	Check that the power supply capacity is sufficient. Connect the power supply correctly.
Supply voltage is out of the specified range.	Set the supply voltage correctly.
Connector is not connected securely.	Connect the connector securely.

<Input indicator (orange) 1 to 8 blinks>

Cause	Remedy
The time for which the safety input is ON exceeds the input mismatch allowable time.	Turn OFF the blinking input block once and turn it ON within the input mismatch allowable time.
Wiring connecting safety contact or safety sensor is disconnected while safety input is ON. (One of duplex inputs is turned OFF.)	Recheck the wiring of the safety inputs, turn OFF the blinking input block, and then turn it ON.

<Interlock indicator (yellow) 1 / 2 lights up>

Cause	Remedy
Reset is not released.	Reset input terminals are not wired. Correctly wire reset input terminals (between INT11 and INT12 or between INT21 and INT22). Use NC contact of forced guide type relay to assure the system safety.
	Relay is welded. Replace the relay.
	The response time of relay is long. Replace the relay with a one whose response time is appropriate.
	Rise-up reset signal has not been entered. (Manual) Use a momentary switch. Replace the switch.

Troubleshooting

<An error is displayed in the 7-segment indicator (red)>

Indication	Description	Cause	Remedy
E0	Set data error	Error due to data mismatch in internal memory	Connect this device to a PC and use the software tool to make factory settings. Refer to " 5-22-1-2 Initialize Settings ".
E2	Error in external circuit power supply (V2, G2)	Error in voltage of power supply connected to external circuit power supply (V2, G2)	Confirm the wiring, supply voltage and supply capacity of the external circuit power supply.
		The external power supply is not turned ON within 30 sec. after the internal power supply is turned ON.	Enter the external power supply within 30 sec. after the internal power supply is turned ON or turn ON the external power supply first.
E4	Safety input circuit error	Failure due to short-circuit between safety input circuits	Confirm the wiring of safety inputs 1 to 8. Check for damage in the safety contacts or safety sensors in connection, and replace them, if necessary.
E5 E9	Control output circuit error	When control output 1 / 2 is ON, it is short-circuited with 0 V or +V.	Correctly wire control output 1 / 2. Refer to " 2-6 Wiring ".
		When control output 1 / 2 is OFF, it short-circuits with +V.	
		Control output terminals short-circuit with each other or with other input / output lines.	
		Excessive current flows in control output 1 / 2.	Current value should be within the specified control output 1 / 2. Refer to " 8-1 Specifications ".
		Output circuit error	Output circuit is damaged. Replace this device.
E6	Switch setting error	The mode selector switch (RUN / PROG) is located at the intermediate position. DIP switch was changed during operation.	Switch the mode selector switch to the correct position of RUN or PROG. Confirm the settings of DIP switch.
E7	Reset input circuit error	When the overall reset is set (one reset), signal enters both inputs 1 and 2.	Wire correctly.
E8	Error in internal circuit current (V1, G1)	Error in voltage of power supply connected to internal circuit power supply (V1, G1)	Inspect the power supply and replace it.
EF	Internal error	Internal failure	Contact our office.

*1: Dots of 7-segment indicator (red) blink.

Chapter 8 Specifications / Dimensions

8-1 Specifications

Model No.		SF-C21
Supply voltage	Power supply for internal	24V DC: ¹⁰ / ₁₅ Ripple P-P 10% or less
	Power supply for external	24V DC: ¹⁰ / ₁₅ Ripple P-P 10% or less
Current consumption	Power supply for internal	200mA or less
	Power supply for external	100mA or less
Safety input (IN1 to IN8)		4 × 2 inputs Rated voltage: Same as voltage of internal power supply
ON level		Input voltage: 18V, Input current: 3.5mA
OFF level		Input voltage: 5V, Input current: 1.0mA
Rated input current		Approx. 5mA
Input impedance		Approx. 4.7kΩ
Duration time of detectable ON state		10ms or more
Duration time of detectable OFF state		0.7ms or less
Control output (OUT1 to OUT4)		PNP open-collector transistor with 2 outputs × 2 <ul style="list-style-type: none"> • Maximum source current: 300mA / output • Applied voltage: Same as voltage of the power supply for external • Residual voltage: 2.5V or less • Leakage current: 100μA or less (Including power supply OFF condition)
Output mode		True: ON, False: OFF
ON delay function		Incorporated
OFF delay function		Incorporated
Short-circuit protection		Incorporated
Response time		OFF response: 10ms or less, ON response: 100ms or less
Auxiliary output (AUX1 to AUX4) (Non-safety output)		PNP open-collector transistor with output × 4 <ul style="list-style-type: none"> • Maximum source current: 60mA / output • Applied voltage: Same as voltage of the power supply for external • Residual voltage: 2.5V or less • Leakage current: 100μA or less (Including power supply OFF condition)
Output mode (Factory defaults)		AUX1: Negative logic of OUT1 / OUT2 (ON when OUT1 / OUT2 is OFF) AUX2: Negative logic of OUT3 / OUT4 (ON when OUT3 / OUT4 is OFF) AUX3: Reset trigger output (ON under reset release wait condition) AUX4: Lockout output (OFF when lockout)
Output mode (Any of the auxiliary outputs can be customized using the software tools)		<ul style="list-style-type: none"> • Negative logic output of OUT1 / OUT2 (ON when OUT1 / OUT2 is OFF) • Negative logic output of OUT3 / OUT4 (ON when OUT3 / OUT4 is OFF) • Positive logic output of OUT1 / OUT2 (ON when OUT1 / OUT2 is ON) • Positive logic output of OUT3 / OUT4 (ON when OUT3 / OUT4 is ON) • Outputs A, B, C, and D of diagnosis results of input blocks 1 to 4 (ON when logic is true) • Outputs E, F, and G of internal logic circuit diagnostic results (ON when logic is true) • Reset trigger output (ON under reset release wait condition) • Lockout output (OFF when lockout) • Muting indicator output (ON when muting / override) • Monitor output in response to IN1 to IN8 (ON when input) • No output (normally OFF)
Short-circuit protection		Incorporated
Response time		10ms or less
Muting indicator output		Semiconductor photo MOS relay output × 1 <ul style="list-style-type: none"> • Maximum load current: 60mA • Same as voltage of the power supply for internal • Residual voltage: 2.5V or less • Leakage current: 100μA or less (Including power supply OFF condition)
Output mode		ON when muting / override
Short-circuit protection		Incorporated
Response time		10ms or less

Specifications / Dimensions

Model No.	SF-C21
Interlock function	Incorporated
Lockout release function	Incorporated
External device monitor function	Incorporated
Communication function (MODBUS RTU)	<ul style="list-style-type: none"> • Interface: RS-485 • Protocol: MODBUS RTU • Maximum transmission distance: 100m • Maximum number of units that can be connected: 8 units (slaves)
Logic selection function	<ul style="list-style-type: none"> • No.0: Customizable logic • No.1: Overall stop control • No.2: Parallel muting control • No.3: Sequential muting control • No.4: Partial stop control 1 • No.5: Partial stop control 2 • No.6: Two-hand control • No.7: OR control • No.8: Operation mode selection control
Logic setting function	Input mode, control mode, output mode, reset mode, auxiliary output mode
Protection structure	IP20 (IEC) (Must surely be installed within a control panel whose protection structure is IP54 or more)
Working ambient temperature	-10 to +55°C (No dew condensation or icing allowed), Storage: -25 to +60°C
Working ambient humidity	30 to 85%RH, Storage: 30 to 85%RH
Voltage withstandability	<p style="text-align: center;">1,000V AC for one min.</p> <p>(All inputs connected together- USB port, all inputs connected together- RS-485 port, USB port - RS-485 port Between all supply terminals connected together and enclosure, all outputs connected together - all input connected together, all outputs connected together - USB port All outputs connected together - RS-485 port)</p>
Insulation resistance	<p style="text-align: center;">20MΩ or more with 500V DC mega</p> <p>(All inputs connected together- USB port, all inputs connected together- RS-485 port, USB port - RS-485 port Between all supply terminals connected together and enclosure, all outputs connected together - all input connected together, all outputs connected together - USB port All outputs connected together - RS-485 port)</p>
Vibration resistance	5 to 8.4Hz half amplitude of 3.5mm, 8.4 to 150Hz acceleration of 9.8m/s ² (1G) (in X, Y and Z directions for two hours each) (IEC / EN 60068-2-6)
Shock resistance	147m/s ² (15G) 11ms in X, Y and Z directions for three times each (IEC / EN 60068-2-27)
Pollution degree	2
Overvoltage category	II
Usable altitude	2,000m or less
Startup time after power on	2 sec. or less
PFH _d (Probability of dangerous failure per hour)	3.09 × 10 ⁻¹⁰
MTTF _d (Mean time to dangerous failure)	100 years or more
DC _{avg}	99%
SFF (Probability of safe failure)	99%
HFT (Hardware fault tolerance)	1
Subsystem type	Type B (IEC 61508-2)
Mission time	20 years
Maximum cable length	100m
Connection method	Input / output and power supply: Detachable spring cage terminal blocks RS-485: Detachable spring cage terminal block USB: MiniB male

Specifications / Dimensions

Model No.	SF-C21
Material	Enclosure: PC / ABS alloy, Cover: PC
Weight	Approx. 190g
Detectable failure mode	Input short-circuits with 0V or +V Inputs short-circuit with each other or with other I/O Control output short-circuits with 0V or +V Control outputs short-circuit with each other or with other I/O Overcurrent flows in control output Internal circuit failure

Note: Do not use or store this device in a pressurized environment beyond the atmospheric pressure at the sea level.

8-2 Dimensions

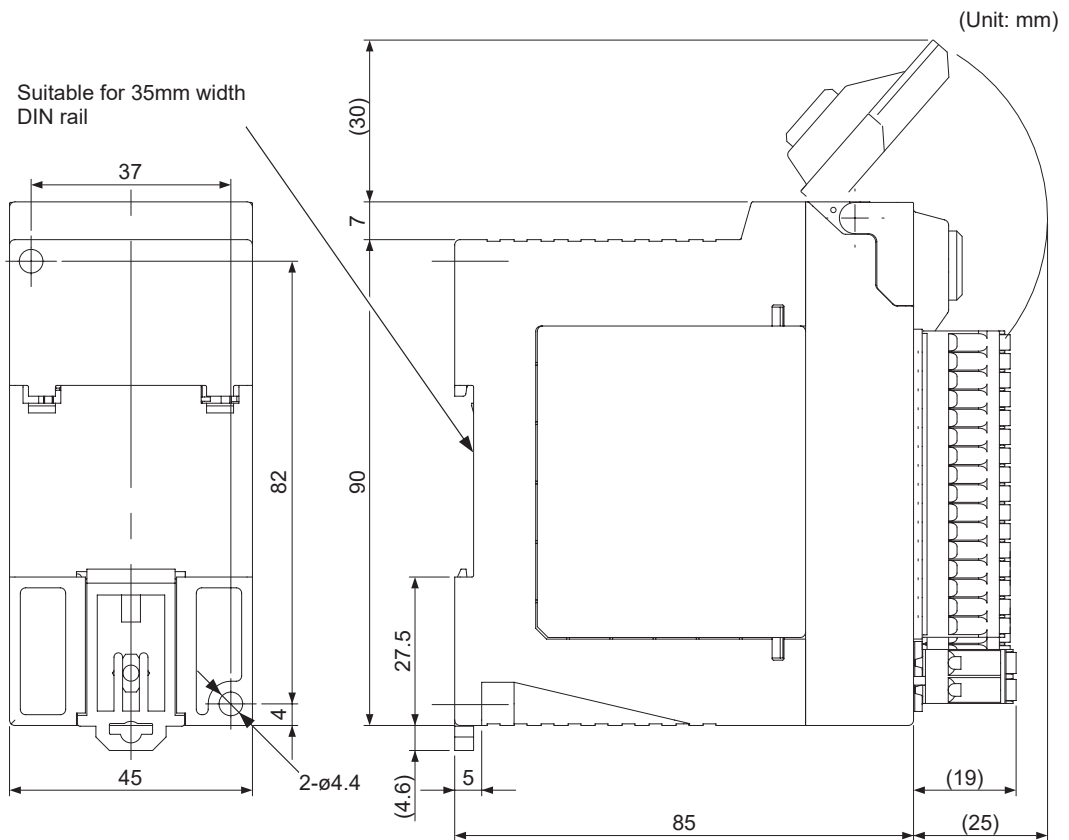

Chapter 9 Others

9-1 Glossary

Machinery Directive / Machinery Regulation	<p>The directive is for safety, which applies to any electronic devices shipped to EU region.</p> <p>This directive is for an assembly of linked parts or components, at least one of which moves and co-operates for a specific purpose, and in which a drive system is incorporated or intended to be incorporated.</p>
EMC Directive / EMC Legislation	<p>The directive is for electromagnetic compatibility, which applies to any electronic devices shipped to EU region.</p> <p>Electronic devices have a possibility of “EMI or emission,” which has them play a role of noise source affecting other electric devices, and a possibility of “EMS or immunity,” which has them affected by noise generated by surrounding electronic devices.</p> <p>EMC means that electronic devices achieve not only reduction of electromagnetic energy emitted, conducted or propagated by themselves, but also resistance to electromagnetic energy generated by surrounding electronic devices.</p>
IEC 61508-1 to 7 JIS C 0508-1 to 7	<p>The standards that pertain to general functional safety for electrical, electronic, and programmable electronic devices.</p> <p>These standards are provided intended to serve as basic and mechanical safety standards that are applicable for various types of industries.</p> <p>Functional safety is defined as the “totally safe part that associates EUC (Equipment under control) and ECU control with a system depending on correct functioning of safety-related system of E/E/PE (electrical/electronic/programmable electronic), other technology safety related systems, and external risk reduction equipment.”</p>
EN 55011	Limits and methods of measurement of radio disturbance characteristics of industrial, scientific and medical (ISM) equipment.
FSD	<p>The abbreviation for Final Switching Device.</p> <p>Components of a safety-related control system of a machine that cuts off the circuit of main element of the machine when control output is turned OFF.</p>
Lockout status	Status in which this device cannot operate normally. In this status, the lockout signal turns OFF all control outputs.

9-2 CE Marking Declaration of Conformity

Itemized Essentials of EU Declaration of Conformity

Manufacturer's Name: Panasonic Industry Co., Ltd.

Manufacturer's Address: 1006, Oaza Kadoma, Kadoma-shi, Osaka
571-8506, Japan

Product Name: Safety Control Unit

Model Number: SF-C20 Series

Trade Name: Panasonic

Application of Council Directive:

- 2006/42/EC Machinery
- 2014/30/EU EMC
- 2011/65/EU RoHS

Applicable Standards:

- | | |
|-----------------------|-------------------|
| - EN ISO 13849-1:2015 | - IEC 61010-2-201 |
| - EN 55011 | - IEC 61131-2 |
| - EN 61000-6-2 | - IEC 61508-1 |
| - EN IEC 62061 | - IEC 61508-2 |
| - EN IEC 63000 | - IEC 61508-3 |

Authorised Representative:

Panasonic Marketing Europe GmbH, Panasonic Testing Centre
Winsbergring 15, 22525 Hamburg, Germany

UKCA Marking Declaration of Conformity

9-3 UKCA Marking Declaration of Conformity

Itemized Essentials of UK Declaration of Conformity

Manufacturer's Name: Panasonic Industry Co., Ltd.

Manufacturer's Address: 1006, Oaza Kadoma, Kadoma-shi, Osaka
571-8506, Japan

Product Name: Safety Control Unit

Trade Name: Panasonic

Model Number: SF-C20 Series

Statutory Instruments:

- 2008/1597 Machinery
- 2016/1091 EMC
- 2012/3032 RoHS

Designated Standards:

- | | |
|-----------------------|-------------------|
| - EN ISO 13849-1:2015 | - IEC 61010-2-201 |
| - EN 55011 | - IEC 61131-2 |
| - EN 61000-6-2 | - IEC 61508-1 |
| - EN IEC 62061 | - IEC 61508-2 |
| - EN IEC 63000 | - IEC 61508-3 |

Panasonic UK, a branch of Panasonic Marketing Europe GmbH
Maxis 2, Western Road, Bracknell, Berkshire, RG12 1RT

Revision history	Revision date	Revision item
1st edition	October , 2014	
2nd edition	December , 2014	—
3rd edition	April , 2015	—
4th edition	January , 2016	—
5th edition	October , 2016	—
6th edition	June , 2021	● Addition of version information
7th edition	August , 2021	● Change due to revision of harmonized standards
8th edition	March , 2022	● Addition of notes about the selection of reset buttons ● Revision of I/O circuit diagrams (2-6-2 I/O Circuit Diagrams)
9th edition	June , 2023	● Revisions to accommodate standards
10th edition	April , 2024	● Change in Corporate name

(MEMO)

1. WARRANTIES:

- (1) Subject to the exclusions stated in 2 (EXCLUSIONS) herein below, our company warrants the Products to be free of defects in material and workmanship for a period of one (1) year from the date of shipment under normal usage in environments commonly found in manufacturing industry.
- (2) Any Products found to be defective must be shipped to our company with all shipping costs paid by Purchaser or offered to our company for inspection and examination. Upon examination by our company, our company will, at its sole discretion, repair or replace at no charge, or refund the purchase price of, any Products found to be defective.

2. EXCLUSIONS:

- (1) This warranty does not apply to defects resulting from any cause:
 - (i) which was due to abuse, misuse, mishandling, improper installation, improper interfacing, or improper repair by Purchaser;
 - (ii) which was due to unauthorized modification by Purchaser, in part or in whole, whether in structure, performance or specification;
 - (iii) which was not discoverable by a person with the state-of-the-art scientific and technical knowledge at the time of manufacture;
 - (iv) which was due to an operation or use by Purchaser outside of the limits of operation or environment specified by our company;
 - (v) which was due to normal wear and tear;
 - (vi) which was due to Force Majeure; and
 - (vii) which was due to any use or application expressly discouraged by our company in 4 (CAUTIONS FOR SAFE USE) hereunder.
- (2) This warranty extends only to the first purchaser for application, and is not transferable to any person or entity which purchased from such purchaser for application.

3. DISCLAIMERS

- (1) Our company's sole obligation and liability under this warranty is limited to the repair or replacement, or refund of the purchase price, of a defective Product, at our company's option.
- (2) THE REPAIR, REPLACEMENT, OR REFUND IS THE EXCLUSIVE REMEDY OF THE PURCHASER, AND ALL OTHER WARRANTIES, EXPRESS OR IMPLIED, INCLUDING, WITHOUT LIMITATION, THE WARRANTIES OF MERCHANTABILITY, FITNESS FOR A PARTICULAR PURPOSE, AND NON-INFRINGEMENT OF PROPRIETARY RIGHTS, ARE HEREBY EXPRESSLY DISCLAIMED. IN NO EVENT SHALL OUR COMPANY AND ITS AFFILIATED ENTITIES BE LIABLE FOR DAMAGES IN EXCESS OF THE PURCHASE PRICE OF THE PRODUCTS, OR FOR ANY INDIRECT, INCIDENTAL, SPECIAL OR CONSEQUENTIAL DAMAGES OF ANY KIND, GENERAL TERMS AND CONDITIONS 4 OR ANY DAMAGES RESULTING FROM LOSS OF USE, BUSINESS INTERRUPTION, LOSS OF INFORMATION, LOSS OR INACCURACY OF DATA, LOSS OF PROFITS, LOSS OF SAVINGS, THE COST OF PROCUREMENT OF SUBSTITUTED GOODS, SERVICES OR TECHNOLOGIES, OR FOR ANY MATTER ARISING OUT OF OR IN CONNECTION WITH THE USE OR INABILITY TO USE THE PRODUCTS.

4. CAUTIONS FOR SAFE USE

- (1) The applications shown in the catalogue are only suggestions, and it is Purchaser's sole responsibility to ascertain the fitness and suitability of the Products for any particular application, as well as to abide by Purchaser's applicable local laws and regulations, if any.
- (2) Never use the Products NOT rated or designated as "SAFETY SENSOR" in any application involving risk to life or property. When such a use is made by Purchaser, such Purchaser shall indemnify and hold harmless our company from any liability or damage whatsoever arising out of or in relation to such use.
- (3) In incorporating the Products to any equipment, facilities or systems, it is highly recommended to employ fail-safe designs, including but not limited to a redundant design, flame propagation prevention design, and malfunction prevention design so as not to cause any risk of bodily injury, fire accident, or social damage due to any failure of such equipment, facilities or systems.
- (4) The Products are each intended for use only in environments commonly found in manufacturing industry, and, unless expressly allowed in the catalogue, specification or otherwise, shall not be used in, or incorporated into, any equipment, facilities or systems, such as those:
 - (a) which are used for the protection of human life or body parts;
 - (b) which are used outdoors or in environments subject to any likelihood of chemical contamination or electromagnetic influence;
 - (c) which are likely to be used beyond the limits of operations or environments specified by our company in the catalogue or otherwise;
 - (d) which may cause risk to life or property, such as nuclear energy control equipment, transportation equipment (whether on rail or land, or in air or at sea), and medical equipment;
 - (e) which are operated continuously each day for 24 hours; and
 - (f) which otherwise require a high level of safety performance similar to that required in those equipment, facilities or systems as listed in (a) through (e) above.

5. EXPORT CONTROL LAWS

In some jurisdictions, the Products may be subject to local export laws and regulations. If any diversion or re-export is to be made, Purchaser is advised to abide by such local export laws and regulations, if any, at its own responsibility.

Panasonic Industry Co., Ltd.

1006, Oaza Kadoma, Kadoma-shi, Osaka 571-8506, Japan
<https://industry.panasonic.com/>

Please visit our website for inquiries and about our sales network.

© Panasonic Industry Co., Ltd. 2014-2024

April, 2024

WUME-SFC21-12