

HL-G2 Configuration Tool **User's Manual**

(MEMO)

Introduction

Thank you for using **HL-G2 Configuration Tool**.

This User's Manual explains how to set up and operate the **HL-G2 Configuration Tool** software, which is used in combination with the **HL-G2** series laser displacement sensor.

Before using this product, read and understand this User's Manual. Use the product correctly and in the optimum manner.

Keep this manual in a safe location for reference whenever necessary.

■ Copyright

The copyright of this manual is owned by Panasonic Industry Co., Ltd. Unauthorized reproduction of this manual is strictly prohibited.

■ Trademarks and registered trademarks

- Microsoft Windows is a trademark or registered trademark of Microsoft Corporation in the United States and/or other countries.
- Intel®Core™ is a trademark or registered trademark of Intel Corporation and its subsidiaries in the United States and/or other countries.
- Ethernet is a trademark or registered trademark of FUJIFILM Business Innovation Corp.
- EtherNet/IP™ is a trademark or registered trademark of Open DeviceNet Vendors Association (ODVA).
- Modbus is a trademark or registered trademark of Schneider Electric USA Inc.
- SLMP is a trademark or registered trademark of Mitsubishi Electric Corporation.

The ownerships of all other trademarks or registered trademarks belong to their respective owners.

Types of Manuals

- There are different types of user's manual for the **HL-G2** series, as listed below. Refer to the appropriate manual according to your need.
- These manuals can be downloaded from our website: <https://industry.panasonic.com/global/en/downloads/?tab=manual>.

Type of sensor / Software name	Manual name	Manual code
Communication type HL-G2	HL-G2 Series User's Manual (Communication Type)	WUME-HLG2CM
Analog output type HL-G2	HL-G2 Series User's Manual (Analog Output Type)	WUME-HLG2AN
Tool software for the HL-G2 series HL-G2 Configuration Tool	HL-G2 Configuration Tool User's Manual	WUME-HLG2CT

Manual Structure

"1 Before Using This Product"	Explains the icons used in this document, as well as the software license agreement
"2 System Configuration"	Explains the system configuration diagram and system requirements
"3 Preparing HL-G2 Configuration Tool"	Explains how to make preparations to use HL-G2 Configuration Tool and how to uninstall the software
"4 Name and Function of Each Window"	Explains the windows and functions of HL-G2 Configuration Tool
"5 Configuring Sensor Settings"	Explains how to set up sensors using HL-G2 Configuration Tool
"6 Setting up Ethernet Communication"	Explains how to set up Ethernet communication using HL-G2 Configuration Tool
"7 Using Convenient Functions"	Explains convenient functions for the use of HL-G2 Configuration Tool
"8 Troubleshooting"	Explains error messages and alarm messages, as well as action methods.

Network Security

This unit may suffer from the following damage during use when connected to the network.

1. Information leakage through this unit
2. Illegal operations of this unit by a malicious third party
3. Obstructing or stopping this unit by a malicious third party

To prevent such damage, you are responsible for taking sufficient network security measures including the following:

- Make sure that the PC connected to this unit is periodically checked against infection by computer viruses and malware and then disinfected.
- Use this unit in an environment where a VPN (Virtual Private Network) or leased line network is established.
- Use this unit in an environment where only limited authorized personnel are allowed to enter.
- Use the PC connected to this unit under secure conditions.

When this unit is connected to an existing LAN, incorrect settings may cause malfunction of devices on the network. Before connecting the unit to an existing LAN, consult your network administrator.

Table of Contents

1 Before Using This Product.....	1-1
1.1 Description of Icons Used in this Document	1-2
2 System Configuration.....	2-1
2.1 System Configuration Diagram	2-2
2.2 Configuration Tool Software " HL-G2 Configuration Tool "	2-4
2.2.1 System requirements	2-4
3 Preparing HL-G2 Configuration Tool.....	3-1
3.1 Flow of Operations up to Setup Completion	3-2
3.2 Optional Cable Connection Method	3-3
3.3 Installation and Uninstallation Procedures	3-5
3.3.1 Installing HL-G2 Configuration Tool	3-5
3.3.2 Uninstalling HL-G2 Configuration Tool	3-7
3.4 Starting and Exiting Procedures	3-8
3.4.1 Starting HL-G2 Configuration Tool	3-8
3.4.2 Exiting HL-G2 Configuration Tool.....	3-12
4 Name and Function of Each Window.....	4-1
4.1 Main Window	4-2
4.2 Menu Bar	4-3
4.2.1 File	4-3
4.2.2 Edit.....	4-5
4.2.3 Tool	4-6
4.2.4 Help.....	4-7
4.3 Quick Access Toolbar	4-8
4.4 Device list.....	4-9
4.4.1 Connection state	4-10
4.4.2 Error and alarm icons.....	4-10
4.4.3 Output state	4-11
4.4.4 Adding sensors	4-11
4.4.5 Removing sensors	4-13
4.5 "Monitor" tab	4-14
4.5.1 Received light intensity waveform monitor.....	4-14
4.5.2 Measured value monitor	4-16
4.5.3 Export as Image / Data output	4-17
4.5.4 I/O monitor	4-19
4.6 "High-speed logging"Tab.....	4-20
4.6.1 High-speed logging	4-21
4.6.2 Data output	4-23
4.7 "Settings" tab	4-25
4.7.1 List of configuration parameters.....	4-26
4.8 "Device information"tab.....	4-28

5	Configuring Sensor Settings	5-1
5.1	Reading and Writing the Settings	5-2
5.1.1	Reading the settings	5-2
5.1.2	Writing the settings	5-2
5.2	Adjusting Sensitivity	5-4
5.2.1	Brightness Tuning	5-4
5.3	Configuring Measurement Settings	5-6
5.4	Configuring Correction Settings	5-7
5.5	Configuring Operation Settings	5-8
5.5.1	Teaching	5-9
5.5.2	Configuring digital output settings	5-12
5.5.3	Configuring alarm settings	5-13
5.6	Performing Configuration	5-14
5.6.1	Bank operation	5-14
6	Setting up Ethernet Communication	6-1
6.1	Configuring IP Settings	6-2
6.1.1	Configuring sensor IP settings	6-2
6.1.2	IP settings for PC	6-3
6.2	Configuring SLMP Settings	6-5
6.2.1	Client communication setting	6-6
6.2.2	Client transmission data setting	6-7
6.2.3	Client data transmission	6-7
6.2.4	Server communication settings	6-8
7	Using Convenient Functions	7-1
7.1	Monitoring Multiple Sensors	7-2
7.1.1	Multimonitor display window	7-4
7.2	Setting Labels to Sensors	7-7
7.3	Configuring Settings Offline	7-8
7.3.1	Creating a new configuration file	7-8
7.3.2	Opening a configuration file	7-9
7.3.3	Writing settings configured offline	7-9
7.4	Copying Settings	7-11
7.4.1	Pasting settings	7-12
7.4.2	Selecting and pasting settings	7-12
7.5	Comparing Settings	7-15
7.6	Protecting Settings	7-17
7.6.1	Setting a password	7-17
7.6.2	Canceling a password	7-18
7.6.3	Initializing a password	7-19
7.7	Initializing Settings	7-21
7.7.1	Initialize Sensor	7-21
7.7.2	Initialize Bank	7-22
8	Troubleshooting	8-1
8.1	Error Messages and Action Methods	8-2

8.2 Alarm Messages and Action Methods8-3

(MEMO)





1 Before Using This Product

1.1 Description of Icons Used in this Document 1-2

1.1 Description of Icons Used in this Document

1.1 Description of Icons Used in this Document

- In this manual, the following symbols are used to indicate safety information that must be observed.

	Indicates an action that is prohibited or a matter that requires caution.
	Indicates an action that must be taken.
	Indicates supplemental information.
	Indicates details about the subject in question or information useful to remember.
	Indicates operation procedures.

2 System Configuration

- 2.1 System Configuration Diagram2-2
- 2.2 Configuration Tool Software "**HL-G2 Configuration Tool**"2-4
 - 2.2.1 System requirements 2-4

2.1 System Configuration Diagram

2.1 System Configuration Diagram

The figure below shows a system configuration and cables connecting each device.

Ethernet communication

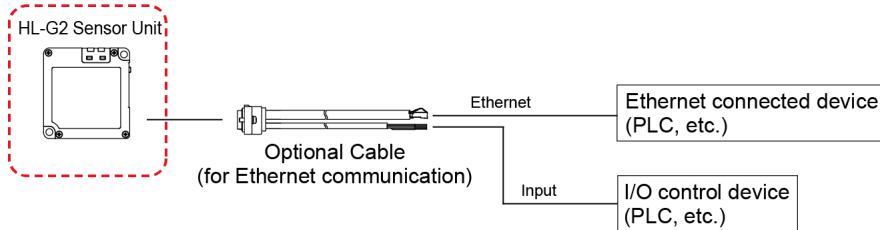

System Configuration Example with tool software Used

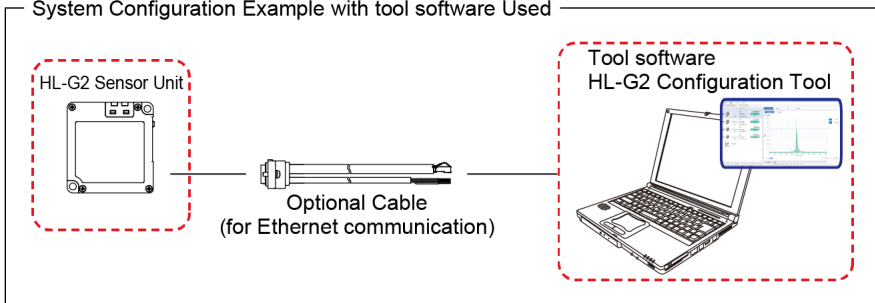

RS-485 communication

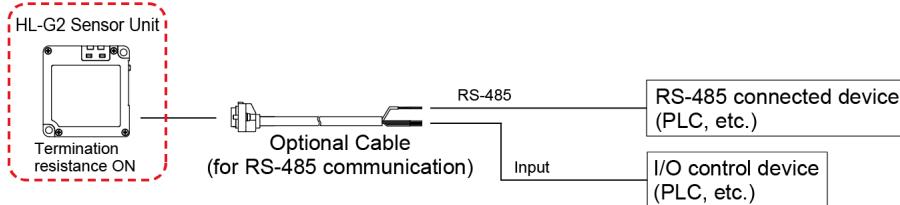

System Configuration Example with tool software Used

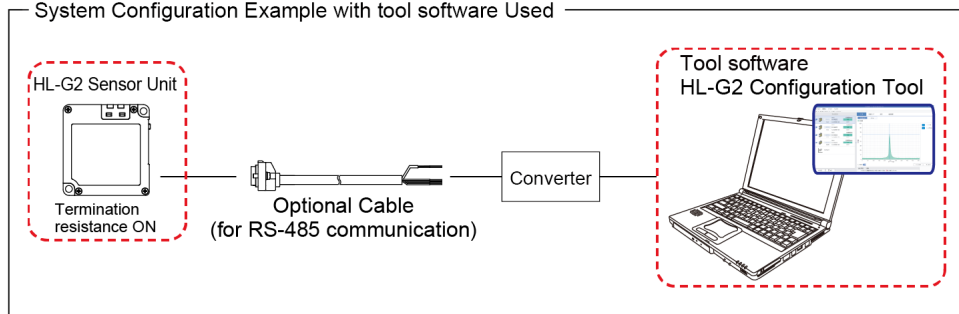

RS-485 wiring allows connection of up to 16 devices.



- This product contains built-in termination resistance. Be sure to turn ON the termination resistance on the terminal unit sensor.

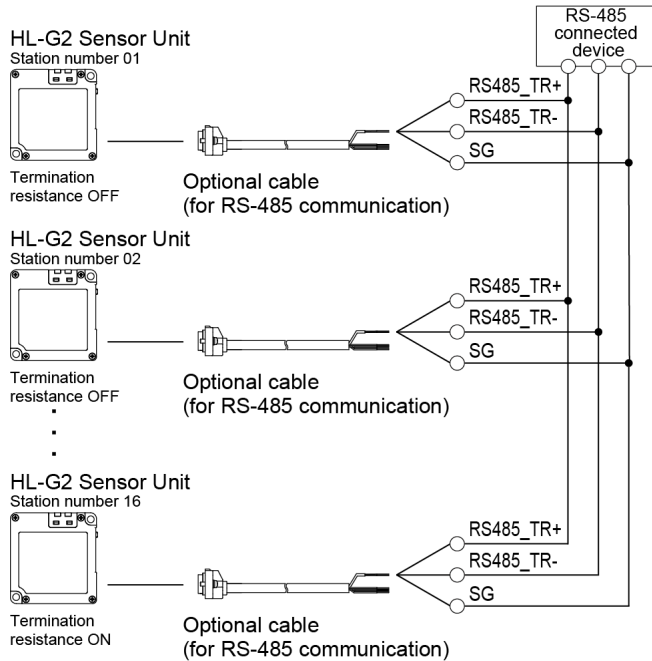

Note

- For stability of RS-485 communication, check the system operation by connecting actual devices on your own. The number of units connected, transmission distance, and transmission speed may vary depending on the connected device and transmission path.
- The maximum cable length of the optional cable (For RS-485 communication) is 20 m. It is recommended that the total cable length from the RS-485 connected device to this product be 20 m or less.
- For RS-485 wiring, use multi-point connection.

2.2 Configuration Tool Software "HL-G2 Configuration Tool"

2.2 Configuration Tool Software "HL-G2 Configuration Tool"

"HL-G2 Configuration Tool" is configuration tool software dedicated to the **HL-G2** series. Installing this tool software on a PC enables the user to set up the connected **HL-G2** sensors, record measured values, and perform other operations.

2.2.1 System requirements

The table below shows the system requirements to use **HL-G2 Configuration Tool**. Check whether the system to be used meets the requirements and the necessary devices are prepared.

Item	Specifications
OS	Microsoft Windows® 10(32bit/64bit) Microsoft Windows® 11(64bit)
CPU	Intel®Core™ i3 1 GHz or more
Memory	2 GB or more
Available hard disk space	200 MB or more
Screen resolution	1366 × 768 or higher (recommended)
Display language	Japanese, English, Chinese (Simplified), and Korean
Communication interface	Ethernet, RS-485
Operating conditions	.NET Frameworks 4.8 or later must be installed.

3 Preparing HL-G2 Configuration Tool

3.1 Flow of Operations up to Setup Completion	3-2
3.2 Optional Cable Connection Method	3-3
3.3 Installation and Uninstallation Procedures	3-5
3.3.1 Installing HL-G2 Configuration Tool	3-5
3.3.2 Uninstalling HL-G2 Configuration Tool	3-7
3.4 Starting and Exiting Procedures	3-8
3.4.1 Starting HL-G2 Configuration Tool	3-8
3.4.2 Exiting HL-G2 Configuration Tool	3-12

3.1 Flow of Operations up to Setup Completion

3.1 Flow of Operations up to Setup Completion

This section explains the flow of **HL-G2 Configuration Tool** operations up to the completion of main unit setup.

1. Preparation

Download **HL-G2 Configuration Tool** from our website (<https://industry.panasonic.com/>) and install it on a PC.

"3.3.1 Installing HL-G2 Configuration Tool"



2. Starting the tool

Connect the sensor and the PC, and start **HL-G2 Configuration Tool**.

"3.2 Optional Cable Connection Method"

"3.4.1 Starting HL-G2 Configuration Tool"



3. Loading the settings

Load the sensor settings into **HL-G2 Configuration Tool**.

"3.4.1 Starting HL-G2 Configuration Tool"



4. Checking the received light intensity waveform

Check the received light intensity waveform.

"4.5 "Monitor" tab"

"4.7 "Settings" tab"



5. Configuring sensor settings

Configure various sensor settings using **HL-G2 Configuration Tool**.

"4.7 "Settings" tab"

"4.7.1 List of configuration parameters"



6. Writing the settings

Write the settings to the sensor.

"5.1.2 Writing the settings"



7. Saving the configuration file

Save the settings on the PC.

"Save as"

3.2 Optional Cable Connection Method



- When using the optional cable, confirm that there is no foreign matters in the connector part before using the cable.
- Always grasp the connector body when connecting or disconnecting the connector. Wires may break if excessive stress is applied to the cable.
- Insert the connector all the way in and tighten the M2.6 screws to this product before using it. If the connectors are not completely connected, the sensor unit may become damaged.



- Do not insert the connector at an angle. Otherwise, connector pins may be bent.

1 2 Procedure

1. Insert the sensor unit connection connector on the optional cable into the sensor unit cable connector.

When doing this, insert the protrusions on the sensor unit connector on the communication cable into the holes on the connector for the sensor unit connection cable.

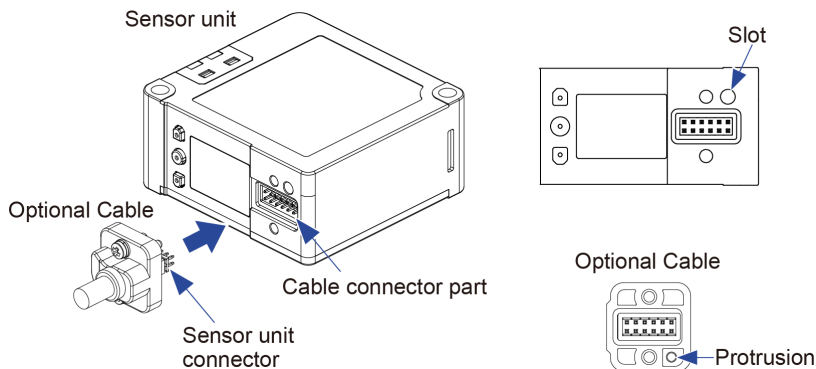

2. Tighten the two M2.6 screw. Tighten the two M2.6 screw. (Tightening torque 0.23 to 0.3 N·m)

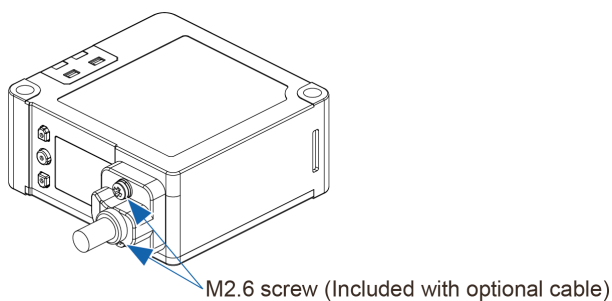

3. When removing the connecting cable from the sensor, loosen the two M2.6 screws, hold the connector part of the cable, and pull out the cable.

3.2 Optional Cable Connection Method

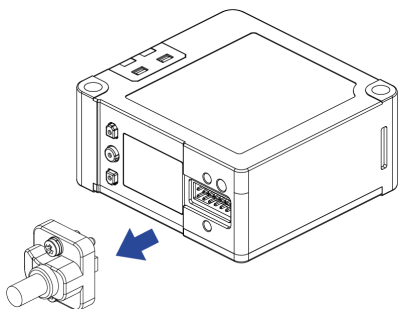

3.3 Installation and Uninstallation Procedures

3.3.1 Installing HL-G2 Configuration Tool

This section explains the procedure for installing **HL-G2 Configuration Tool** on a PC.

i Info.

- The "User Account Control" confirmation window may be displayed. In such a case, click [Yes] to proceed with the change procedure.

1 2 Procedure

1. Double-click the "setup.exe" file that you downloaded.
2. Select the target language and click [OK].

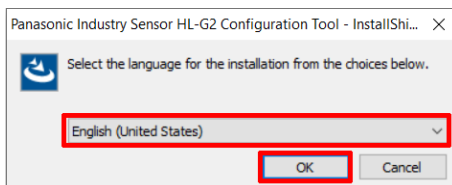

3. Click [Next].

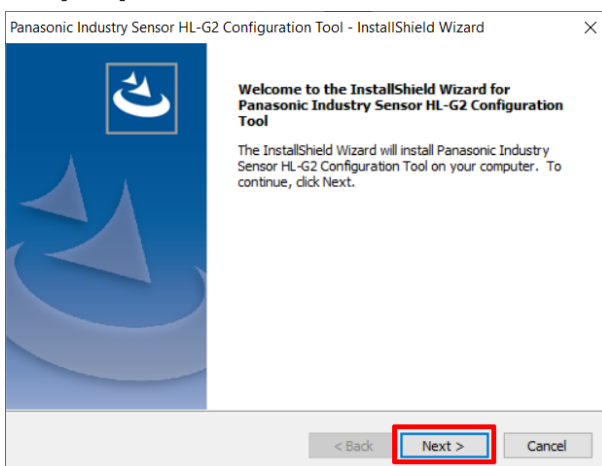

4. The "License Agreement" window will be displayed. Carefully read the agreement, select "I accept the terms of the license agreement", and click [Next].

3.3 Installation and Uninstallation Procedures

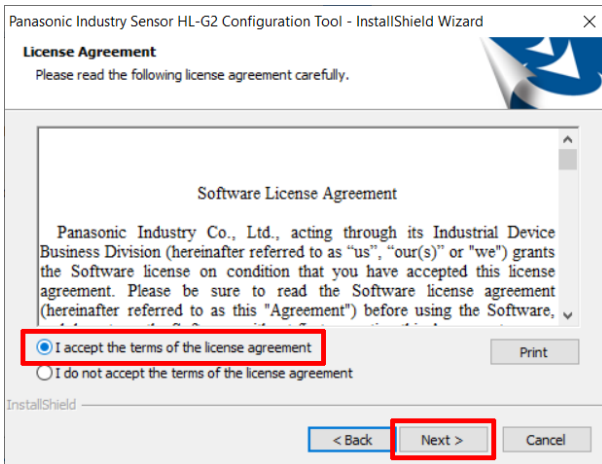

5. If you do not change the installation folder, click[Next]. If you change the installation folder, select a desired folder and then click[Next].

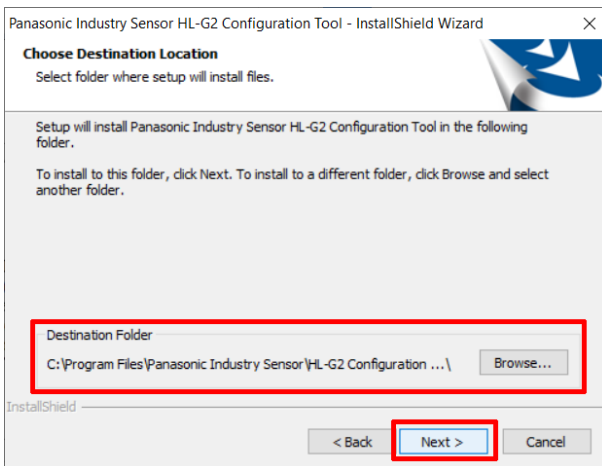

6. Click[Install].

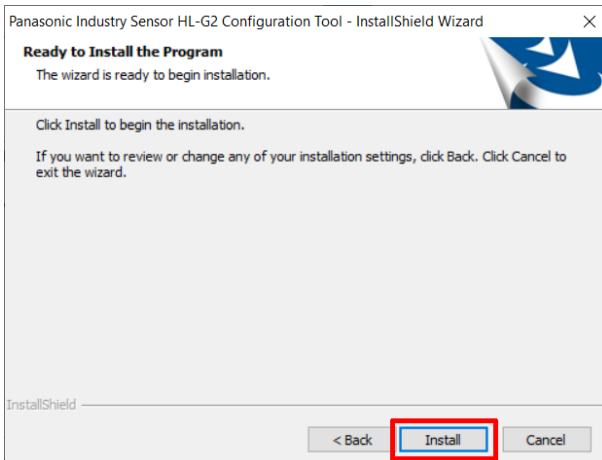

7. Click[Finish].

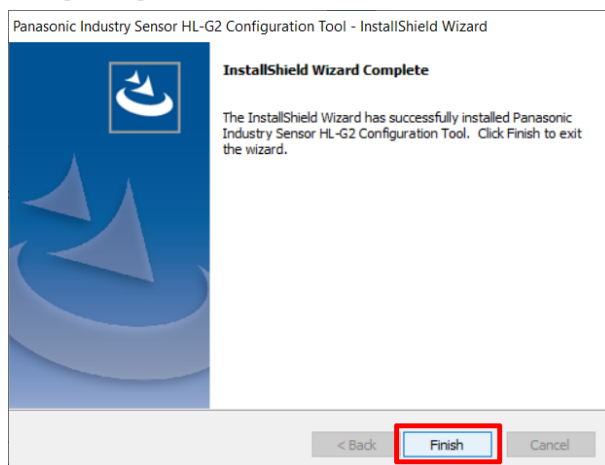

8. The HL-G2 Configuration Tool icon will be displayed on the desktop.



3.3.2 Uninstalling HL-G2 Configuration Tool

To uninstall **HL-G2 Configuration Tool**, on the Windows desktop, right-click **Start>Settings>Apps>Apps & features** and then select **Panasonic Industry Sensor HL-G2 Configuration Tool** and execute uninstallation.

3.4 Starting and Exiting Procedures

3.4 Starting and Exiting Procedures

3.4.1 Starting HL-G2 Configuration Tool

This section explains the procedure for starting **HL-G2 Configuration Tool**.

1 2 Procedure

1. Double-click the **HL-G2 Configuration Tool** icon on the Windows desktop, or from the Windows start menu, select **Panasonic Industry Sensor>HL-G2 Configuration Tool**.



2. When **HL-G2 Configuration Tool** is started, the "Start menu" window is displayed.

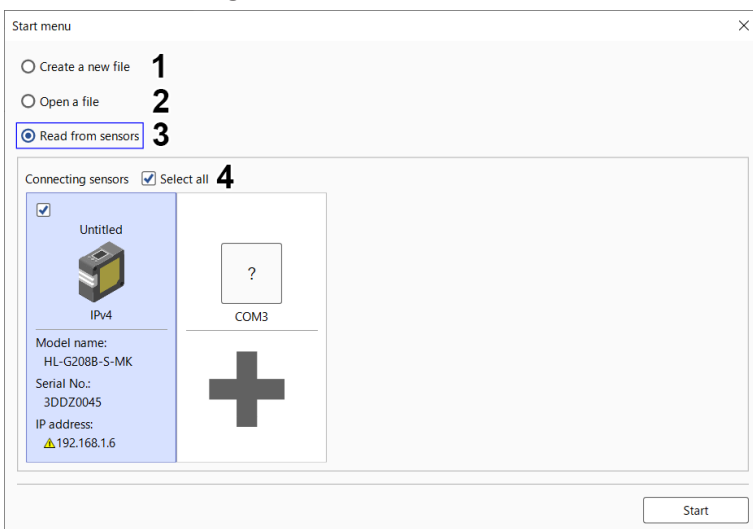

No.	Item	Description
1	Create a new file	This item allows the user to create a new configuration file. For details, refer to "7.3.1 Creating a new configuration file" .
2	Open a file	This item allows the user to open an existing configuration file. For details, refer to "7.3.2 Opening a configuration file" .
3	Read from sensors	This item allows the user to read settings from sensors. For the procedure for reading settings from connected sensors, refer to "Reading settings from connected sensors" . For the procedure for searching for serial communication sensors, refer to "Searching for serial communication sensors" .
4	"Connecting sensors" display area	This area displays the sensors that are currently connected. If "Read from sensors" is selected, this area will be enabled.

3. Select a desired startup method and click [Start].

Reading settings from connected sensors

If "Read from sensors" is selected in the "Start menu" dialog box, select the sensors connected to the PC to create a device list. For details on device lists, refer to ["4.4 Device list"](#).



Select the check boxes of the sensors from which settings are to be read and then click [Start].

3.4 Starting and Exiting Procedures

Note

- If the "Select all" check box is selected, the check boxes of all sensors will be selected. Similarly, if the "Select all" check box is canceled, the check boxes of all sensors will be canceled.
- If there is a problem with IP address settings, a warning icon will be displayed.

Model name:

HL-G208B-S-MK

Serial No.:

3DDZ0045

IP address:

 192.168.1.6

In such a case, check for the following problems.

1. The subnet of the sensors differs from that of the PC.
2. There are duplicate sensor IP addresses.

Clicking the warning icon or IP address text displays an IP settings change dialog box, so that you can change the IP address settings.

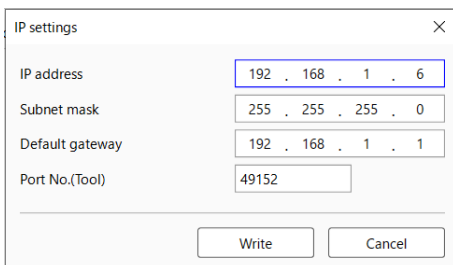

The image shows a dialog box titled "IP settings" with a close button (X) in the top right corner. It contains four input fields: "IP address" with the value "192 . 168 . 1 . 6", "Subnet mask" with "255 . 255 . 255 . 0", "Default gateway" with "192 . 168 . 1 . 1", and "Port No.(Tool)" with "49152". At the bottom, there are two buttons: "Write" and "Cancel".

If you have changed the IP settings, click [Write] to write the settings to the sensor, Note that setting duplicate IP addresses for the PC and sensors may prevent the automatic configuration from configuring the IP settings as intended. If changing the IP settings fails, refer to "6.1.1 Configuring sensor IP settings".

Searching for serial communication sensors

This section explains the procedure for searching for sensors connected via serial communication.

1 2 Procedure

1. Click the target port number on the right side of the "Connecting sensors" area.

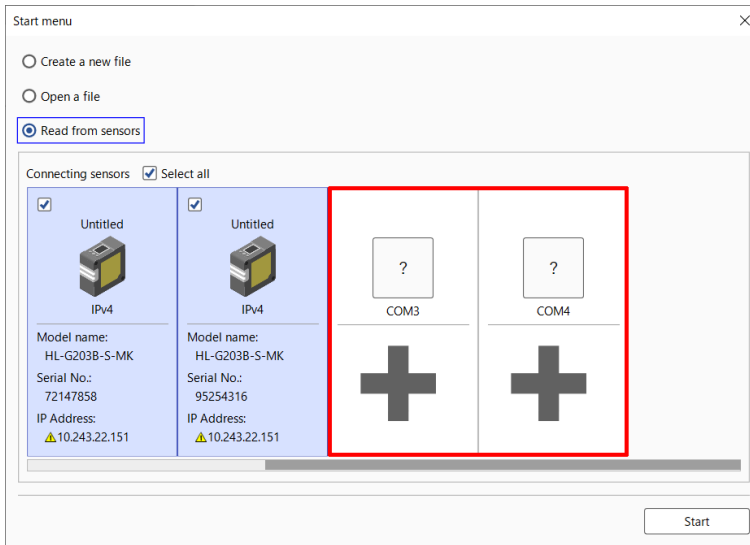

2. Configure settings in the "Device Address", "Comm Speed", "Data length", "Parity", and "Stop Bit" fields and then click [Search].

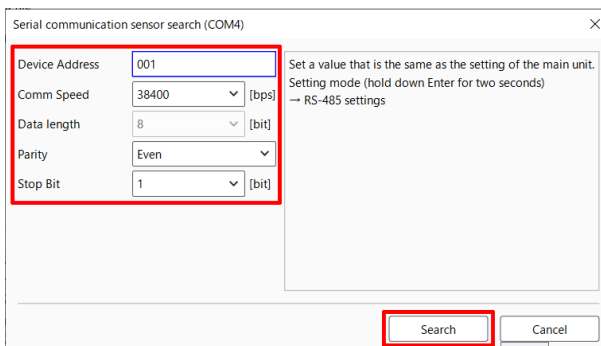

i Info.

- For each parameter, set the same values as the settings of the connected sensor. Holding down the [Enter] button on the sensor for two seconds invokes the "Setting mode" in which you can check the communication settings.

3. A confirmation dialog box will be displayed, asking whether to conduct sensor searches. Clicking [Yes] starts searching.

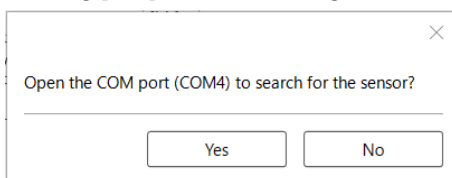

4. Found sensors will be added to the "Connecting sensors" area.

3.4 Starting and Exiting Procedures

3.4.2 Exiting HL-G2 Configuration Tool

Use one of the following methods to exit **HL-G2 Configuration Tool**.



- A confirmation message will be displayed, asking whether to save the configuration file. If you must save the configuration file, click[Yes]. If you click[No], the changed settings will be discarded.

- On the menu bar, select **File>Exit**.
- Click the[close]button in the top right corner of the tool software window.

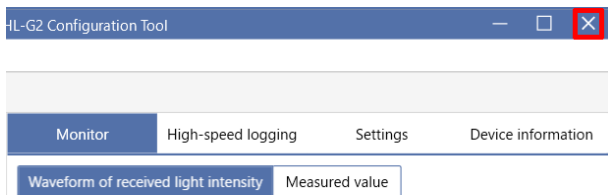

4 Name and Function of Each Window

4.1 Main Window	4-2
4.2 Menu Bar	4-3
4.2.1 File	4-3
4.2.2 Edit.....	4-5
4.2.3 Tool	4-6
4.2.4 Help.....	4-7
4.3 Quick Access Toolbar	4-8
4.4 Device list.....	4-9
4.4.1 Connection state	4-10
4.4.2 Error and alarm icons.....	4-10
4.4.3 Output state	4-11
4.4.4 Adding sensors	4-11
4.4.5 Removing sensors	4-13
4.5 "Monitor" tab	4-14
4.5.1 Received light intensity waveform monitor.....	4-14
4.5.2 Measured value monitor	4-16
4.5.3 Export as Image / Data output	4-17
4.5.4 I/O monitor	4-19
4.6 "High-speed logging"Tab.....	4-20
4.6.1 High-speed logging	4-21
4.6.2 Data output	4-23
4.7 "Settings" tab	4-25
4.7.1 List of configuration parameters.....	4-26
4.8 "Device information"tab.....	4-28

4.1 Main Window

4.1 Main Window



	Name	Description	Reference section
1	Menu bar	Displays the menus of each function used by HL-G2 Configuration Tool	"4.2 Menu Bar"
2	Quick Access Toolbar	Arranges icons that allow the user to quickly execute frequently used functions such as "New", "Save", and "Copy"	"4.3 Quick Access Toolbar"
3	Title bar	Displays the configuration file name and tool software name	—
4	Device list	Displays the sensors that are currently edited or connected	"4.4 Device list"
5	"Monitor" tab	Allows the user to check the received light intensity waveforms, I/O, and measured values of the selected sensor	"4.5 "Monitor" tab"
6	"High-speed logging" tab	Allows the user to record measured values in every sampling cycle for the purpose of sensor performance evaluation or maintenance	"4.6 "High-speed logging" Tab"
7	"Settings" tab	Allows the user to set up the selected sensor	"4.7 "Settings" tab"
8	"Device information" tab	Allows the user to check device information for the selected sensor	"4.8 "Device information" tab"

4.2 Menu Bar

This section explains the functions that can be executed from the menu bar.

4.2.1 File

This menu allows the user to set operations related to configuration files, as well as options and language.

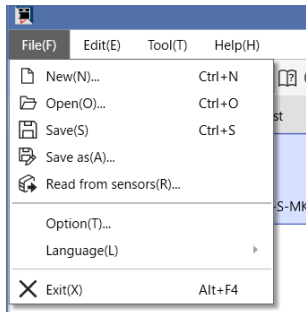

New

This item allows the user to create a new configuration file. (Shortcut keys: <Ctrl>+<N> keys)
For details, refer to ["7.3.1 Creating a new configuration file"](#).

Open

This item allows the user to open an existing configuration file. (Shortcut keys: <Ctrl>+<O> keys)
For details, refer to ["7.3.2 Opening a configuration file"](#).

Save

This item allows the user to overwrite an existing configuration file. (Shortcut keys: <Ctrl>+<S> keys)

Save as

This item allows the user to rename and save the specified file.

Note

- The save format is "HL-G2 settings" format and the extension is ".hlg".

4.2 Menu Bar

Read from sensors

Select the sensors connected to the PC to create a device list. For details on device lists, refer to "4.4 Device list".



- If the device list has been changed, a confirmation message will be displayed, asking whether to save the configuration file. If you must save the configuration file, click [Yes]. If you click [No], the changed settings will be discarded.

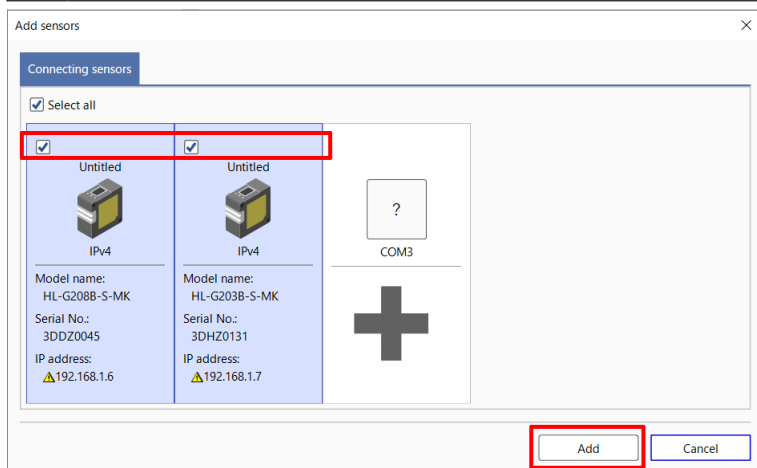

To read settings from connected sensors, select the check boxes of the sensors from which settings are to be read and then click [Add]. For details, refer to "[Reading settings from connected sensors](#)". For the procedure for searching for serial communication sensors, refer to "[Searching for serial communication sensors](#)".

Option

Specifying a password prevents the settings of sensors from being changed. For details, refer to "[7.6.1 Setting a password](#)".



Note

- If you have forgotten the specified password, you can initialize the password. For details on the initialization procedure, refer to "[7.6.3 Initializing a password](#)".

Language

This item allows the user to select a desired display language for **HL-G2 Configuration Tool**.

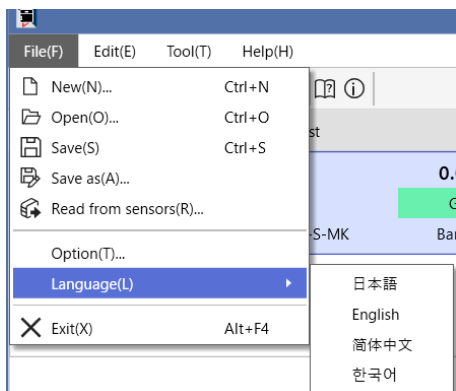

If you have changed the display language, you must restart **HL-G2 Configuration Tool**. A confirmation message will be displayed. If you click [Yes], **HL-G2 Configuration Tool** will be restarted and the change will be applied.

Exit

This item allows the user to exit **HL-G2 Configuration Tool**. (Shortcut keys: <Alt>+<F4> keys)

4.2.2 Edit

This menu allows the user to copy the settings of one sensor and paste them to another sensor.

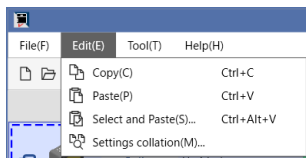

Copy

This item allows the user to copy all settings of the specified sensor. (Shortcut keys: <Ctrl>+<C> keys)

For details, refer to ["7.4 Copying Settings"](#).

Paste

This item allows the user to paste the copied settings to a different sensor. (Shortcut keys: <Ctrl>+<V> keys)

For details, refer to ["7.4.1 Pasting settings"](#).

Select and Paste

This item allows the user to paste only the selected parts of copied settings to a different sensor. (Shortcut keys: <Ctrl>+<Alt>+<V> keys)

For details, refer to ["7.4.2 Selecting and pasting settings"](#).

4.2 Menu Bar

Settings collation

This item allows the user to compare sensor settings and check the differences. For details, refer to "7.5 Comparing Settings".

4.2.3 Tool

This menu allows the user to diagnose sensor states.



Diagnostic information

The diagnostic information window is shown below.

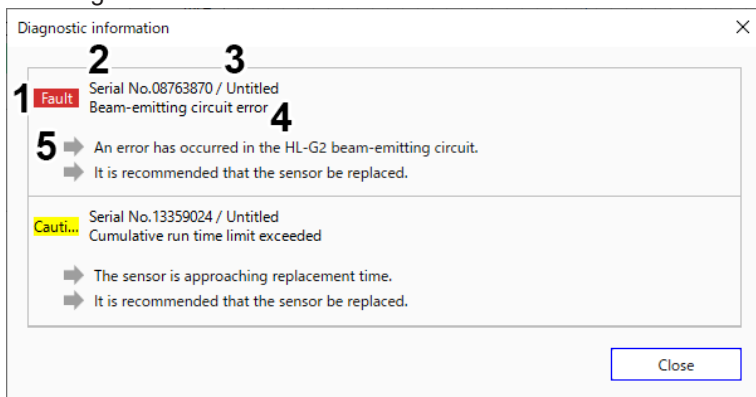

	Name	Function
1	State	The following sensor states are displayed. "Fault": Indicates the state in which sensor replacement or wiring check is required due to component damage or wiring breakage or for some other reason. "Caution": Indicates the state in which sensor replacement is recommended because the saving count has exceeded the upper limit, for example. "Notification": Indicates the state in which issues that occur during normal use, such as setting errors or a drop in received light intensity, are detected.
2	Serial No.	Indicates the serial number of the connected sensor.
3	Label	Indicates the label set for the connected sensor. For details, refer to "7.2 Setting Labels to Sensors".
4	Diagnostic result	Indicates the problem detected by diagnosis.
5	Action	Indicates the action that should be taken to resolve the problem.

4.2.4 Help

This menu allows the user to refer to the manual and check the software version of **HL-G2 Configuration Tool**.

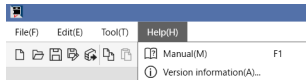

Manual

This item allows the user to refer to the manual of **HL-G2 Configuration Tool**.

Version information



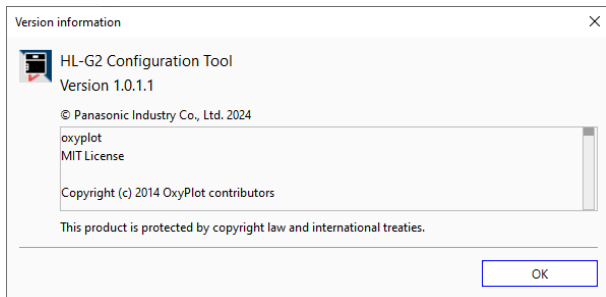









This item allows the user to check version information for **HL-G2 Configuration Tool**.



4.3 Quick Access Toolbar

4.3 Quick Access Toolbar

Some functions can be executed from their respective icons on the Quick Access Toolbar.

Icon	Name	Reference section
	New	"New", "7.3.1 Creating a new configuration file"
	Open	"Open", "7.3.2 Opening a configuration file"
	Save	"Save"
	Save as	"Save as"
	Read from sensors	"Read from sensors"
	Copy	"Copy", "7.4 Copying Settings"
	Paste	"Paste", "7.4.1 Pasting settings"
	Select and Paste	"Select and Paste", "7.4.2 Selecting and pasting settings"
	Settings collation	"7.5 Comparing Settings"
	Diagnostic information	"Diagnostic information"
	Manual	"Manual"
	Version information	"Version information"

4.4 Device list

This window displays a list of sensors that are currently connected or edited. If you select a sensor in the "Device list" window, the "Monitor" tab, "High-speed logging" tab, "Settings" tab, and "Device information" tab for the selected sensor will be enabled. The "Device list" window consists of the components shown below.

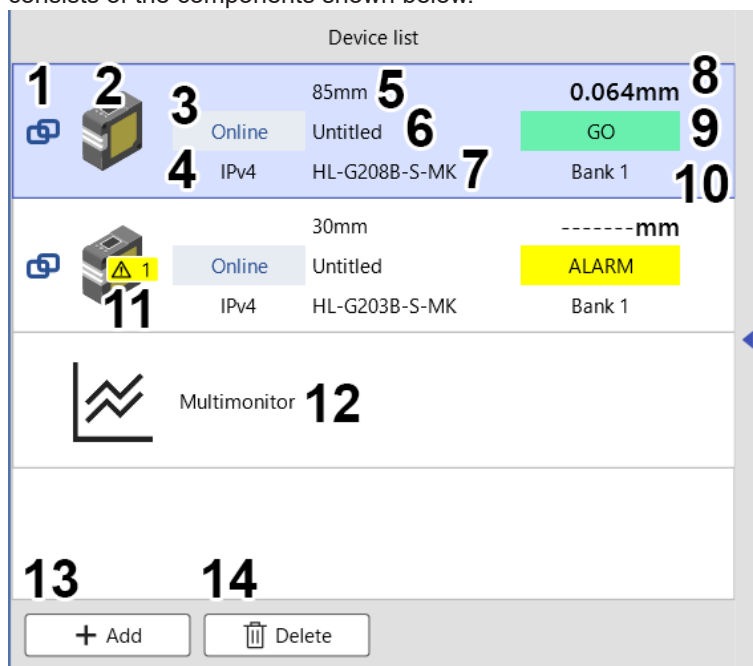





	Name	Description
1	Connection state icon	This icon indicates the connection state of the sensor and PC. For details, refer to "4.4.1 Connection state" .
2	Product image	This icon is a visual representation of the product. Clicking the icon displays the occurrence situation of errors and alarms.
3	Connection state	This section indicates the connection state of the sensor and PC. For details, refer to "4.4.1 Connection state" .
4	Communication interface	This section indicates the communication interface of the connected sensor.
5	Product type	This section indicates the product type of the connected sensor.
6	Label	This section indicates the label set for the sensor. For details, refer to "7.2 Setting Labels to Sensors" .
7	Model	This section indicates the model of the sensor.
8	Measured value	This section indicates the measured value from the sensor.
9	Output state	This section indicates the output state of the sensor. For details, refer to "4.4.3 Output state" .
10	Selected bank	This section indicates the selected bank. For details, refer to "5.6.1 Bank operation" .

4.4 Device list

	Name	Description
11	Error and alarm icons	These icons indicate the occurrence situation of sensor errors and alarms, as well as the number of occurrences. For details on the icons, refer to "4.4.2 Error and alarm icons" . For details on how to resolve sensor errors and alarms, refer to "8 Troubleshooting" .
12	Multimonitor	This function monitors multiple sensors. For details, refer to "7.1 Monitoring Multiple Sensors" .
13	[Add] button	Clicking this button adds new or connected sensors to the "Device list" window. For details, refer to "4.4.4 Adding sensors" .
14	[Delete] button	Clicking this button removes sensors from the "Device list" window. For details, refer to "4.4.5 Removing sensors" .

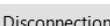

4.4.1 Connection state

The connection state of the sensor and PC is displayed as below.

Connection state	Icon display	Status display	Description
Offline setting	None		The sensor has not been connected at all. <ul style="list-style-type: none"> The status is displayed as[Connection]. The "Monitor" tab is not displayed. No graph is displayed in the "Settings" tab and "Not connected."is displayed.
Connected			The sensor is connected online.
Disconnection			The sensor was connected online once, but it was disconnected. <ul style="list-style-type: none"> No graph is displayed in the "Settings" tab and "Waveform cannot be collected."is displayed. Errors and alarms cannot be collected from the sensor unit.







4.4.2 Error and alarm icons

If an error occurs on the sensor or the specified alarm conditions are satisfied, the icons shown below and the number of occurrences will be displayed on the product image. Clicking on the product image displays details of the error or alarm.

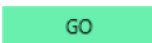
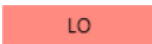
Display	Description
	An error occurred on the sensor. For details on how to resolve the error, refer to "8.1 Error Messages and Action Methods" .
	The specified alarm conditions are satisfied. For details on how to resolve the alarm, refer to "8.2 Alarm Messages and Action Methods" .

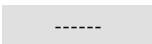
4.4.3 Output state

The output states of connected sensors are displayed as below.

Output state	Display	Conditions
GO		The measured value displayed is within the threshold range.
LOW		The measured value displayed dropped below the LOW set value. (Note 1)
HIGH		The displayed measured value exceeded the upper threshold. (Note 2)
Data indeterminate		Measurement is not made correctly. This is not an error.
Out of display range (+)		The measured value exceeded the display range on the positive side. (Note 3)
Out of display range (-)		The measured value exceeded the display range on the negative side. (Note 4)
Error		An error occurred on the sensor. For details on how to resolve the error, refer to "8.1 Error Messages and Action Methods" .
Alarm		The specified alarm conditions are satisfied. For details on how to resolve the alarm, refer to "8.2 Alarm Messages and Action Methods" .

(Note 1) When the measured value displayed and the LOW set value are the same, the output state may be "LOW".

(Note 2) When the measured value displayed and the HIGH set value are the same, the output state may be "HIGH".

(Note 3) When data is output, the measured value is fixed at +960.

(Note 4) When data is output, the measured value is fixed at -960.

4.4.4 Adding sensors

This section explains how to add sensors to the "Device list" window.

1.2 Procedure

1. Click the [Add] button on the bottom of the "Device list" window.

4.4 Device list

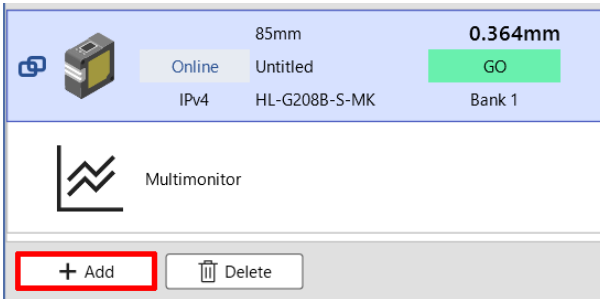

2. The "Add sensors" menu window will be displayed. Select sensors to be added. If the "New Sensors" tab is selected, you can select any new sensors. If the "Connected Sensors" tab is selected, you can select sensors to be added from all the connected sensors.

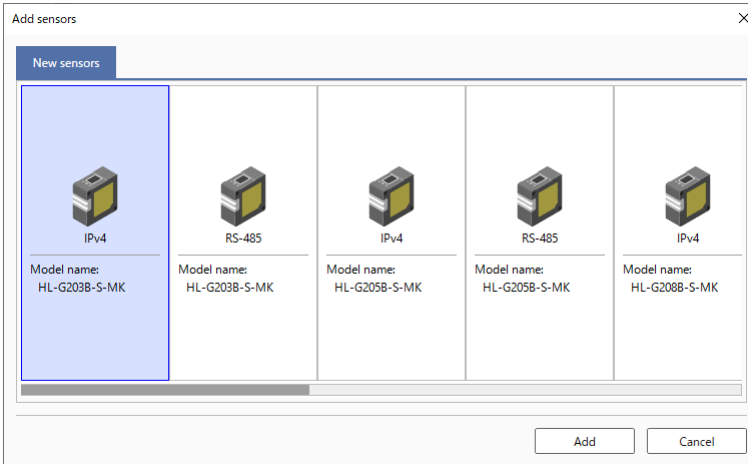

3. Clicking the [Add] button adds the selected new sensors to the "Device list" window.

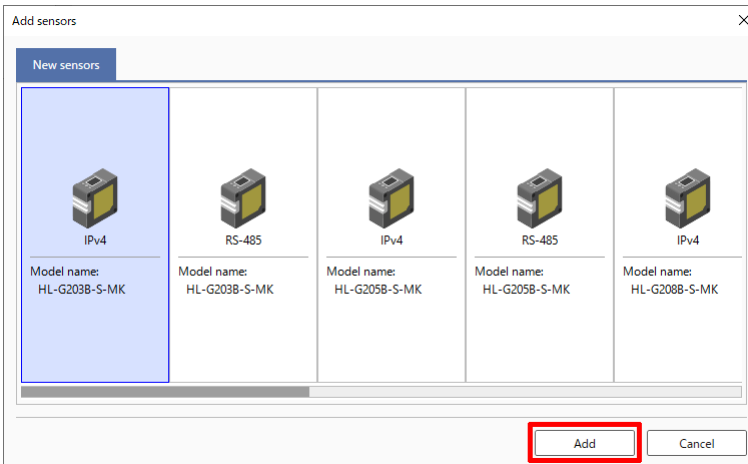

4.4.5 Removing sensors

This section explains how to remove sensors from the "Device list" window.

1 2 Procedure

1. Select sensors to be removed from the "Device list" window and click the [Delete] button.

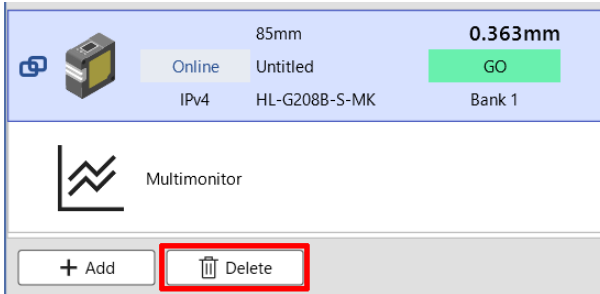

2. A confirmation message will be displayed. Clicking [Yes] removes the selected sensors from the "Device list" window.

4.5 "Monitor" tab

4.5 "Monitor" tab

This tab allows the user to monitor the waveform of received light intensity, measured values, and I/O of sensors.

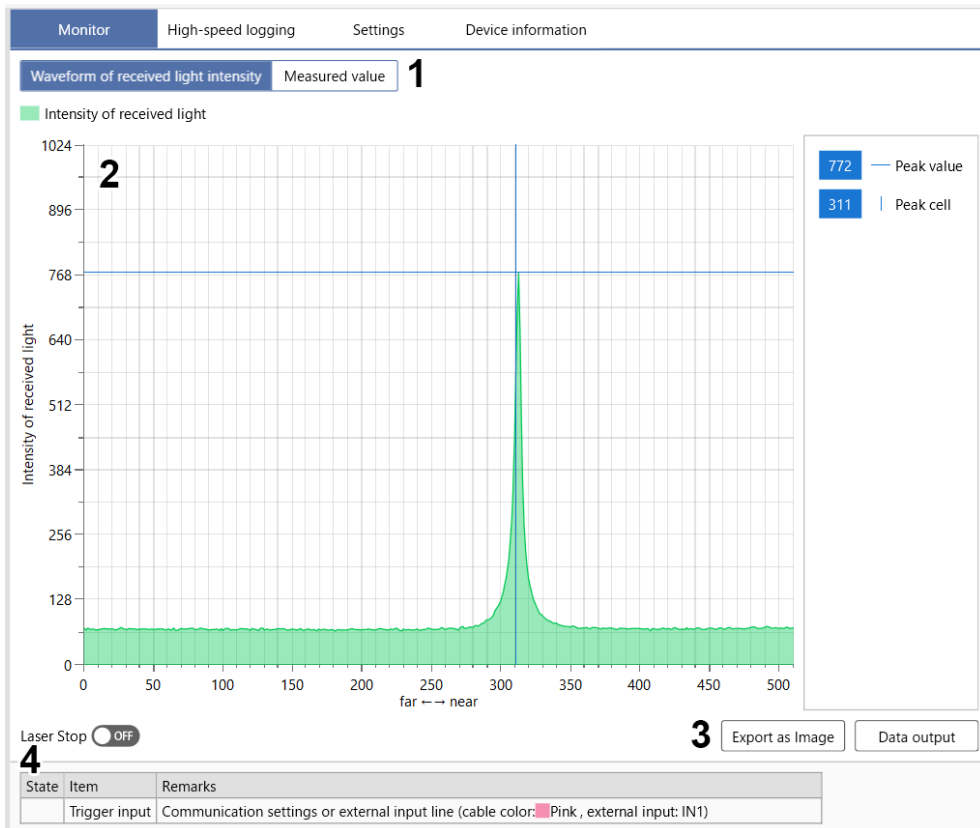

	Name	Description
1	Monitor selector	This section allows the user to switch the display between "Waveform of received light intensity" and "Measured value".
2	Waveform of received light intensity monitor / Measured value monitor	Each tab displays waveform of received light intensity or measured values. For details, refer to "4.5.1 Received light intensity waveform monitor" or "4.5.2 Measured value monitor" .
3	Image output / Data output	Clicking each button outputs waveform of received light intensity or measured values to a file. For details, refer to "4.5.3 Export as Image / Data output" .
4	I/O monitor ^(Note 1)	This section indicates the I/O state. For details, refer to "4.5.4 I/O monitor" .

(Note 1) "I/O monitor" is not displayed when the Multimonitor function is used.

4.5.1 Received light intensity waveform monitor

This area displays the received light intensity waveforms of sensors.

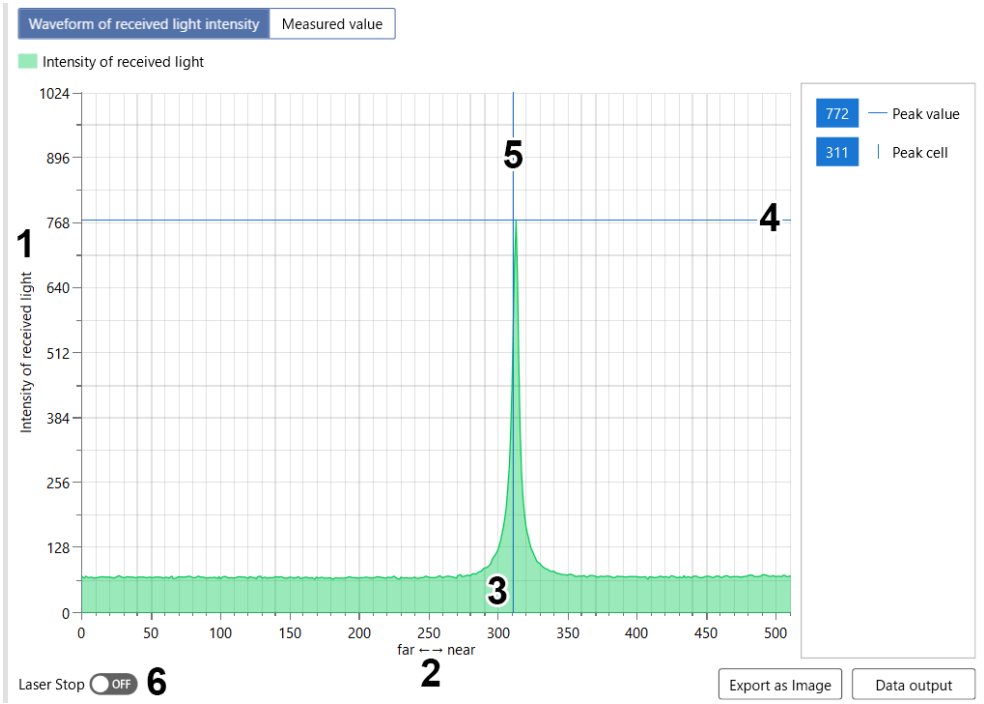

	Name	Description
1	Vertical axis	This axis represents the intensity of received light.
2	Horizontal axis	This axis represents each cell position in the light receiving section of the sensor.
3	Received light intensity waveform	<p>This graph is drawn by plotting received light intensities and cell positions.</p> <ul style="list-style-type: none"> Normally, received light intensity waveforms are displayed in green. In the event of an alarm, received light intensity waveforms are displayed in yellow.^(Note 1) If received light intensity waveforms cannot be collected due to laser emission OFF or for some other reason, the entire display area will be grayed out. The display area can be zoomed in or zoomed out by rotating the mouse wheel while the mouse pointer is within the display area. The display area can also be zoomed in or zoomed out at low speed by rotating the mouse wheel while holding down the <Ctrl> key.
4	Peak value	This section indicates the maximum value of received light intensity waveforms.
5	Peak cell	This section indicates the cell position of the peak value.
6	Laser Stop ^(Note 2)	<p>This switch allows the user to stop or start laser emission.</p> <ul style="list-style-type: none"> Setting [Laser Stop] to ON stops laser emission. Setting [Laser Stop] to OFF starts laser emission.

(Note 1) If an alarm is delayed or hold is set in the event of an alarm, the color of the graph may remain green even when received light intensity waveforms are in the alarm state.

(Note 2) "Laser Stop" is not displayed when the Multimonitor function is used.

4.5 "Monitor" tab

4.5.2 Measured value monitor

This tab allows the user to display measured values or perform logging to continue collecting measured values in any desired data cycle.

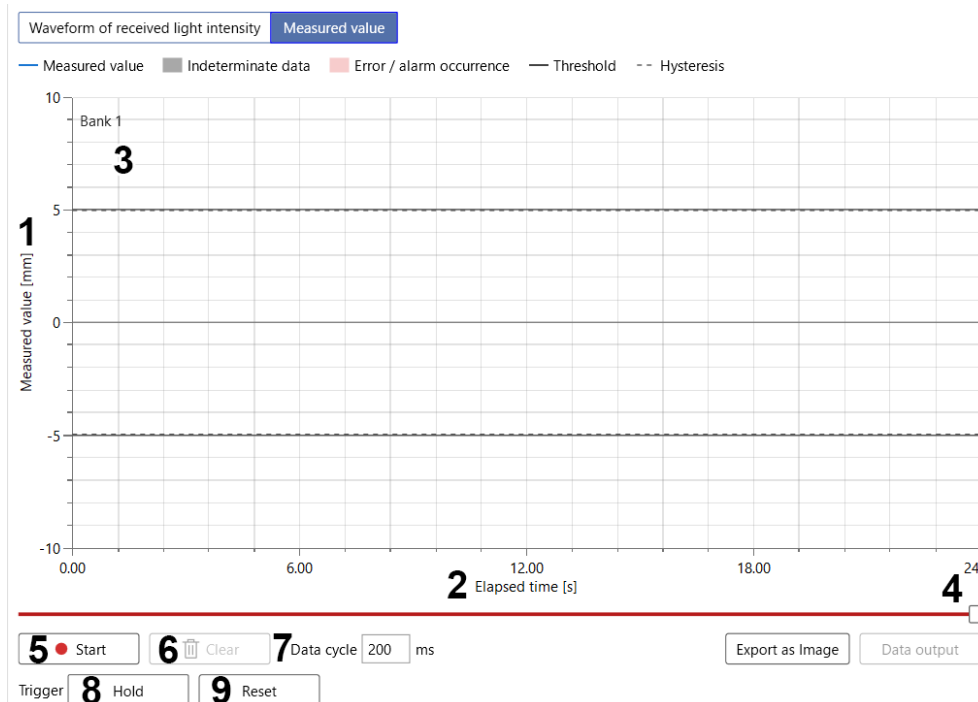

	Name	Description
1	Vertical axis	This axis represents measured values.
2	Horizontal axis	This axis represents the elapsed time from the start of logging. The axis scrolls horizontally in accordance with the elapsed time.
3	Measured value graph	This graph is drawn by plotting measured values and elapsed time. The display area can be zoomed in or zoomed out by rotating the mouse wheel while the mouse pointer is within the display area. The display area can also be zoomed in or zoomed out at low speed by rotating the mouse wheel while holding down the <Ctrl>key.
4	Slider	This slider allows the user to change the display range of measured value graphs.
5	[Start]button [Pause]button [Resume]button	This button allows the user to perform logging to continue collecting measured values in any desired time cycle. <ul style="list-style-type: none"> Clicking the "Start" button before the start of logging starts logging. The button display will be changed as follows:Start>Pause. Clicking the "Pause" button during logging pauses logging. The button display will be changed as follows:Pause>Resume. <i>(Note 2)</i> Clicking the "Resume" button during paused logging resumes logging. The button display will be changed as follows:Resume>Pause.
6	[Clear]button	This button allows the user to erase logged results. If you click the [Clear]button and then [Yes] in the confirmation message window, you can erase the logged results and start new logging.
7	Data cycle	This section indicates the time cycle in which measured values are to be collected by logging.

	Name	Description
		The minimum settable value is 10 ms and the maximum settable value is 400 ms. (Note 3)
8	[Hold]button	This button allows the user to switch the hold state between ON and OFF.(Note 4) (Note 5)
9	[Reset]button	This button sends "Measured Value Resetting" to the sensor.(Note 4)(Note 5)

(Note 1) The maximum allowable number of measurement times per logging is 60,000.

(Note 2) Logged data is not saved at the time of pause. For details on how to save logged data, refer to "4.5.3 Export as Image / Data output".

(Note 3) By default, the data cycle is set to 200 ms.

(Note 4) The [Hold] and [Reset] buttons are used to perform trigger input. For details on trigger input, refer to the *HL-G2 Series User's Manual (Communication Type)*.

(Note 5) The [Hold] and [Reset] buttons are not displayed when the Multimonitor function is used.

Note

If an abnormality occurs during logging, the following will be displayed.

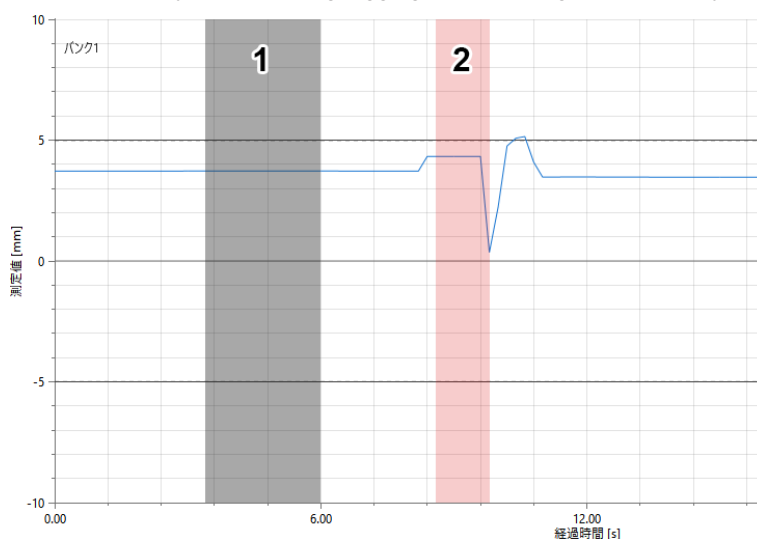

	Name	Description
1	Data loss Indeterminate data	When data is lost or becomes indeterminate, the zone where such a problem has occurred is displayed as a gray background.
2	Error / alarm occurrence Out of display range	When an error or alarm occurs or data goes beyond or falls below the display range, the zone where such a problem has occurred is displayed as a red background.

4.5.3 Export as Image / Data output

The "Export as Image" or "Data output" button allows the user to perform image output or data output for graph information displayed in the Monitor window.

4.5 "Monitor" tab

Export as Image

This section explains how to output graphs displayed in the Monitor window as image data in PNG format.

1 2 Procedure

1. Click the [Export as Image] button.

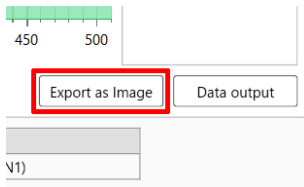

2. The "Save as" dialog box will be displayed. Specify a storage location and file name and then click [Save].
3. Graphs will be output in PNG format to the specified storage location.

Data output

This section explains how to output graphs displayed in the Monitor window as data in XLSX or CSV format.

1 2 Procedure

1. Click the [Data output] button.

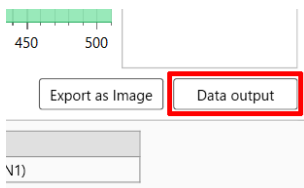

2. The "Save as" dialog box will be displayed. Specify a storage location, file name, and data format and then click [Save].
3. A file with the specified format will be output to the specified storage location.

Note

The "Data output" button in the Monitor window outputs the following kinds of data.

Received light intensity waveform monitor	Measured value monitor
<ul style="list-style-type: none"> Received light intensity peak state (Normal or abnormal) Peak value Peak cell Cell number (Horizontal axis of graph) Received light intensity (Vertical axis of graph) Creation of graphs on "Graph of received light intensity" sheet (For XLSX format) 	<ul style="list-style-type: none"> Measurement start date Data cycle Time of acquisition (Horizontal axis of graph) Measured value (Vertical axis of graph) Error information Creation of graphs on "Measured value logging graph" sheet (For XLSX format)

4.5.4 I/O monitor

This section displays the I/O ON/OFF states of connected sensors, allocated functions, and other information.

1 2 3

State	Item	Remarks
●	Trigger input	Communication settings or external input line (cable color: ■ Pink, external input: IN1)

	Name	Description
1	State	The ON/OFF state of I/O is displayed. ON: ● is displayed. OFF: None
2	Item	The allocated function is displayed.
3	Remarks	Supplemental information on I/O monitor is displayed. (Note 1)

(Note 1) External I/O information is displayed as "cable color" and "cable No."

4.6 "High-speed logging"Tab

4.6 "High-speed logging"Tab

This tab allows the user to record measured values in every sampling cycle for the purpose of sensor performance evaluation or maintenance.

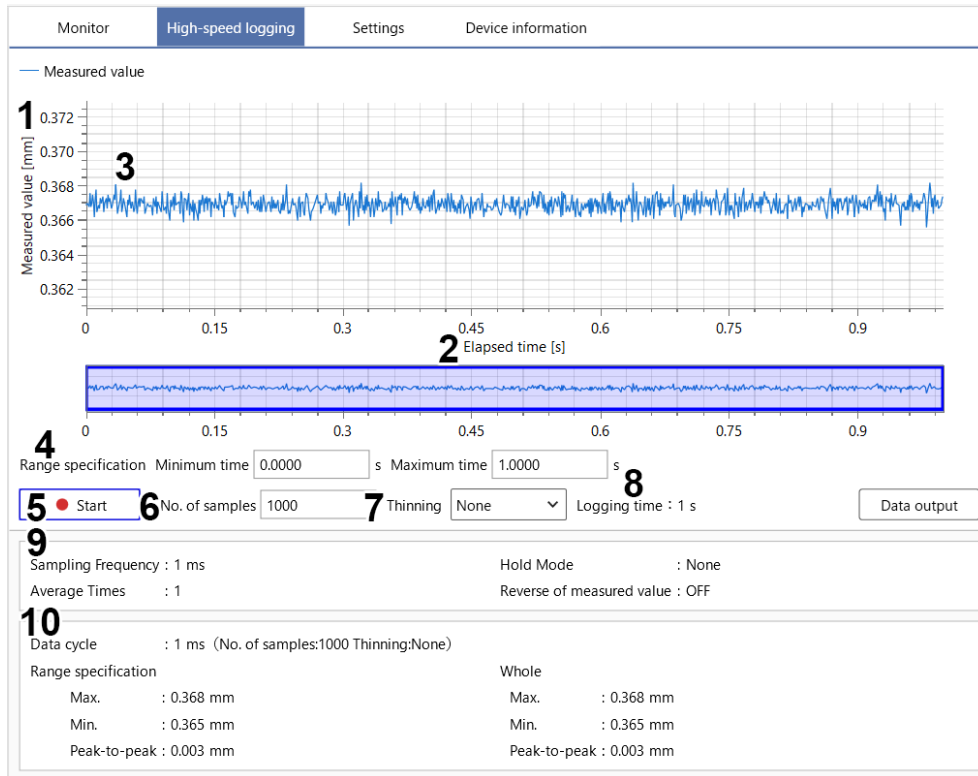

	Name	Description
1	Vertical axis	This axis represents measured values.
2	Horizontal axis	This axis represents elapsed time.
3	Measured value graph	This graph is drawn by plotting measured values and elapsed time.
4	Range specification	This section allows the user to specify the display range for logging results. Values can be entered only after logging.
5	[Start]button	This button allows the user to start high-speed logging. For details on the operating method, refer to "4.6.1 High-speed logging".
6	No. of samples ^(Note 1)	This section allows the user to specify the number of times sampling is performed for high-speed logging. Sampling is performed the specified number of times.
7	Thinning	This section allows the user to specify an interval used to thin out sampling. If, for example, "1/4" is specified, sampling is performed to obtain a measured value from one of four sampling operations. In this case, measurement time is four times longer than the normal measurement time.
8	Logging time ^(Note 2)	This value indicates approximate time required for logging. It is calculated from the values in "Sampling cycle," "No. of samples," and "Thinning."
9	Parameters	This area displays configuration parameters related to the conditions for high-speed logging.

	Name	Description
		For details on each parameter, refer to "4.7.1 List of configuration parameters".
10	Logging results	<p>This area displays the logging conditions, entire logging results, and the logging results of the area specified by "Range specification."</p> <ul style="list-style-type: none"> • Maximum value: Maximum value within the entire area or the area specified by "Range specification" • Minimum value: Minimum value within the entire area or the area specified by "Range specification" • Peak-to-peak: Difference between the maximum value and minimum value

(Note 1) The maximum number of samples is 30,000.

(Note 2) Displays only the time taken for measurement. Depending on the communication environment, it may take time to display results after completion of measurement.

4.6.1 High-speed logging

This section explains how to perform high-speed logging.

1 2 Procedure

1. In the "Settings" tab, set the following parameters.

- Sampling Frequency
- Average Times
- Hold Mode
- Reverse of Measured Value

For details on how to set these parameters, refer to "4.7 "Settings" tab". For details on each parameter, refer to "4.7.1 List of configuration parameters".

2. In the "High-speed logging" tab, set the following parameters.

- No. of samples
- Thinning

For details on each parameter, refer to "4.6 "High-speed logging"Tab".

3. Click the [Start] button to start logging.

4.6 "High-speed logging" Tab

Range specification Minimum time 0.0000 s Maximum time 1.0000 s

Start No. of samples 1000 Thinning None Logging time : 1 s

Sampling Frequency : 1 ms Hold Mode : None
Average Times : 1 Reverse of measured value : OFF

4. Check the logging results. Entering values in the "Range specification" section allows the user to adjust the display area for graphs.

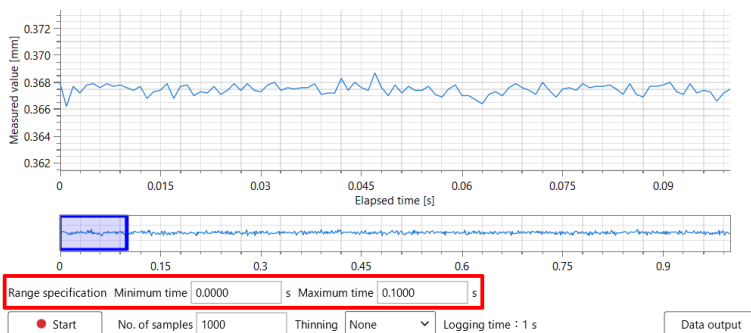
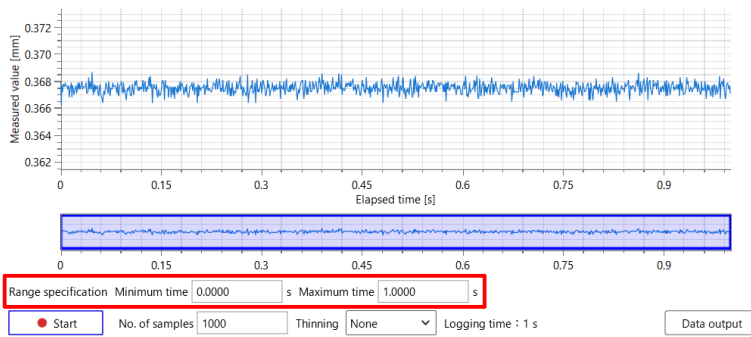

Note

- If the following operations are performed, logged data will be cleared.
 - Changing the tab
 - Changing the selected sensor in the "Device list" window
 - Exiting **HL-G2 Configuration Tool**
 - Adding or removing sensors to/from the "Device list" window
 - Connecting sensors
 - Executing "Read from sensors"
 - Executing "New" or "Open" from the "File" menu

4.6.2 Data output

This section explains how to output graphs displayed in the "High-speed logging" tab as data in XLSM or CSV format.

1 2 Procedure

1. Click the [Data output] button.

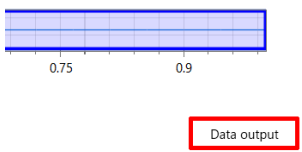

2. The "Save as" dialog box will be displayed. Specify a storage location, file name, and data format and then click [Save].

Note

- The "Data output" button in the "High-speed logging" tab outputs the following kinds of data.
 - Date of measurement start
 - Model name
 - Interface
 - Serial No.
 - System version (version information of the sensor unit)
 - Distance type
 - Sampling cycle [ms]
 - Average count
 - Hold mode
 - Inversion of Measured Value
 - Data cycle [ms]
 - No. of samples
 - Thinning
 - Maximum elapsed time [s]
 - Minimum elapsed time [s]
 - Maximum measured value [mm]
 - Minimum measured value [mm]
 - Peak-to-peak [mm]
 - Creation of graphs on "High-speed logging graph" sheet (For XLSM format)

High-speed logging graph

If you have output logging results as data in XLSM format, create graphs on the "High-speed logging graph" sheet. Create two types of graph: "Measured value graph (whole)" and

4.6 "High-speed logging"Tab

"Measured value graph (specified range)". In "Measured value graph (specified range)", you can adjust the display range.

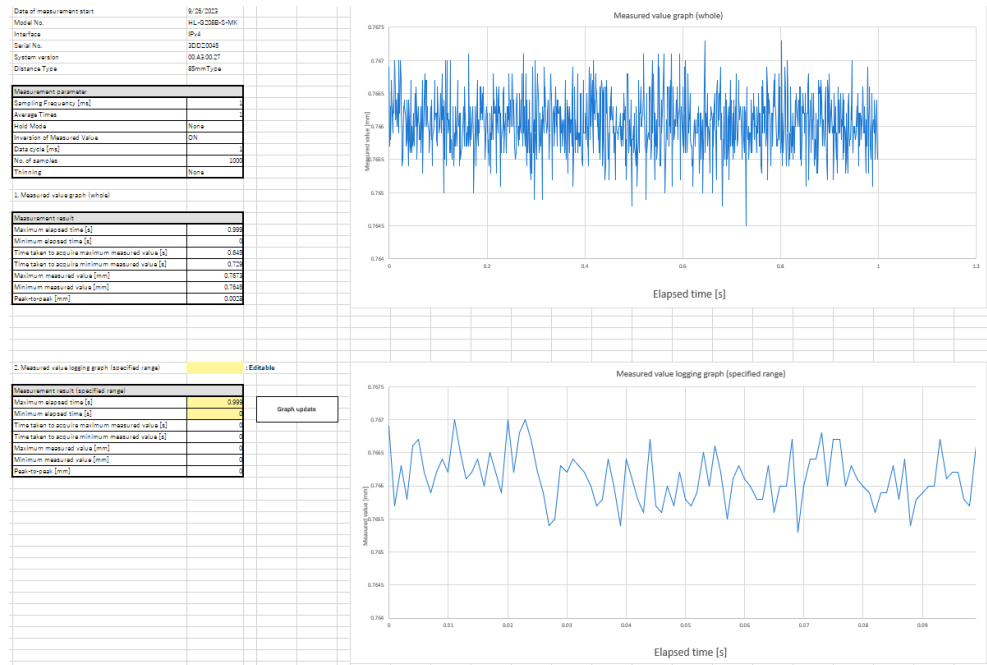

To adjust the display range, enter the maximum elapsed time and minimum elapsed time of the display range in the yellow cells and then click the [Graph update] button.

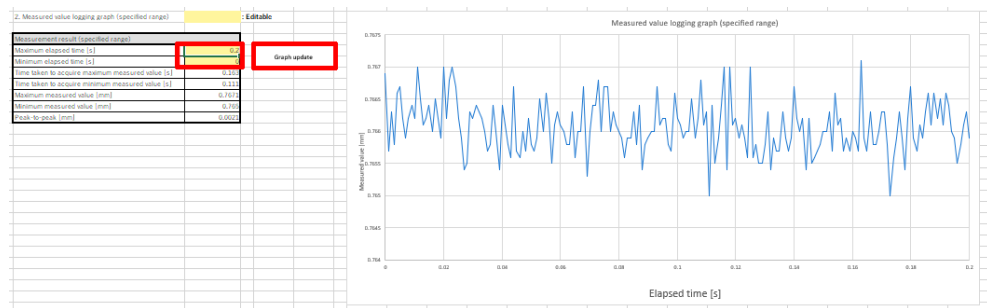

4.7 "Settings" tab

This tab allows the user to set up each parameter for the selected sensor.

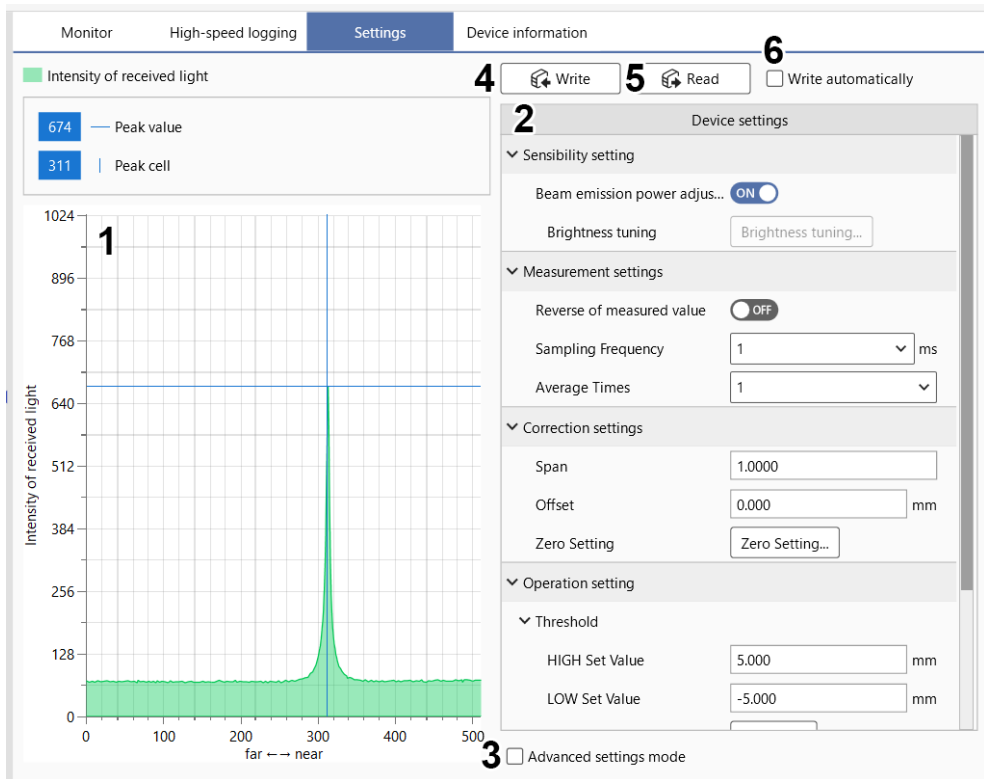

	Name	Function	Reference section
1	Received light intensity waveform monitor	This area displays received light intensity waveforms.	"4.5.1 Received light intensity waveform monitor"
2	Configuration parameter area	This area allows the user to check and edit each parameter for the selected sensor. When HL-G2 Configuration Tool is started, this area is displayed in "simple settings mode" in which only the general parameters are displayed.	"4.7.1 List of configuration parameters"
3	"Advanced settings mode" check box	Selecting this check box displays all parameters in the configuration parameter area so that more detailed settings can be specified.	"4.7.1 List of configuration parameters"
4	[Write] button	Clicking this button writes the parameter settings in the configuration parameter area to the sensor.	"5.1.2 Writing the settings"
5	[Read] button	Clicking this button reads the parameter settings from the sensor and reflects them into the configuration parameter area.	"5.1.1 Reading the settings"
6	"Write automatically" check box	Selecting this check box automatically reads the parameter settings from the sensor and reflects them into the configuration parameter area. Similarly,	

4.7 "Settings" tab

Name	Function	Reference section
	when each parameter is changed, the parameter settings will be automatically written to the sensor even if the [Read] button is not clicked.	

4.7.1 List of configuration parameters

The following list shows the parameters and items that can be set with **HL-G2 Configuration Tool**.

For details on each parameter, refer to the sections in the "Reference section" column and the *HL-G2 Series User's Manual (Communication Type)*.

Configuration parameter		Advanced settings mode ^(Note 1)	Reference section	
Sensitivity setting	Brightness Tuning		"5.2 Adjusting Sensitivity"	
Measurement settings	Inversion of Measured Value		"5.3 Configuring Measurement Settings"	
	Sampling period			
	Average Times			
Correction settings	Span		"5.4 Configuring Correction Settings"	
	Offset			
	Zero Setting			
	Hold Mode	•		
	Trigger Mode	•		
Operation setting	Threshold		"5.5 Configuring Operation Settings" "5.5.1 Teaching"	
	HIGH Set Value			
		LOW Set Value		
	Teaching			
	Hysteresis	•		
	Output Delay Timer			
	Timer selection		•	"5.5 Configuring Operation Settings"
		Timer setting	•	"5.5.2 Configuring digital output settings"
	Alarm			
	Delay count at alarm occurrence		•	"5.5 Configuring Operation Settings"
Digital output at alarm occurrence		•	"5.5.3 Configuring alarm settings"	
Configuration	Bank settings			
	Item to be read and written		"5.6 Performing Configuration"	
		Bank operation		"5.6.1 Bank operation"
	Number of digits displayed	•	"5.6 Performing Configuration"	
Eco mode	•			

Configuration parameter		Advanced settings mode ^(Note 1)	Reference section
	Reverse video	•	
	Key lock	•	
	Display language	•	

(Note 1) The items marked with • in the "Advanced settings mode" column are displayed only when the "Advanced settings mode" check box is selected.

4.8 "Device information" tab

4.8 "Device information" tab

This tab allows the user to check device information and set a label, perform initialization, configure IP settings, and perform other operations for the selected sensor.

Ethernet communication type

Monitor High-speed logging Settings **Device information**

HL-G2



1 Label :

2 Model No. : HL-G203B-S-MK

Interface : IPv4

Serial No. : 3DHZ0131

System version : 00.A3.00.27

Distance Type : 30mmType

3

4

5

6

IP settings

IP Address :

Subnet Mask :

Default Gateway :

Port No.(Tool) :

Port No.(Modbus) :

7

Maintenance information

Item	Value
Cumulative operating period [h]	126

Serial communication type

Monitor High-speed logging Settings **Device information**

HL-G2



1 Label :

2 Model No. : HL-G203B-S-MK

Interface : RS-485

Port No. : COM4

Device Address : 001

Serial No. : 3DHZ0130

System version : 00.A3.00.27

Distance Type : 30mmType

3

4

7 Maintenance information

Item	Value
Cumulative operating period [h]	23

	Name	Function	Reference section
1	Label	This field allows the user to check and set a label.	"7.2 Setting Labels to Sensors"
2	Sensor information	This section displays information for the selected sensor.	
3	[Initialize Sensor]button ^(Note 1)	This button allows the user to initialize sensor settings.	"7.7.1 Initialize Sensor"
4	[Initialize Bank]button ^(Note 1)	Clicking this button initializes the specified bank.	"7.7.2 Initialize Bank"
5	[SLMP settings]button ^(Note 2)	Clicking this button allows the user to check and set up SLMP communication.	"6.2 Configuring SLMP Settings"
6	IP settings ^(Note 2)	This section allows the user to check and set up Ethernet IP.	"6.1 Configuring IP Settings"
7	Maintenance information ^(Note 3)	This section displays the cumulative operating period of the sensor (in hours).	

- (Note 1) Executing [Initialize Sensor] or [Initialize Bank] deletes the set values. Before execution, we recommend that you save the configuration file. For details on saving a configuration file refer to "4.2.1 File".
- (Note 2) The [SLMP settings] button and "IP settings" are displayed only for the Ethernet communication type.
- (Note 3) The value of "Cumulative operation hours" is updated when the "Device information" tab is displayed. When the cumulative operating period exceeds 87,600 hours, the diagnostic information function displays "Caution".

(MEMO)

5 Configuring Sensor Settings

5.1 Reading and Writing the Settings	5-2
5.1.1 Reading the settings	5-2
5.1.2 Writing the settings.....	5-2
5.2 Adjusting Sensitivity	5-4
5.2.1 Brightness Tuning	5-4
5.3 Configuring Measurement Settings.....	5-6
5.4 Configuring Correction Settings	5-7
5.5 Configuring Operation Settings.....	5-8
5.5.1 Teaching.....	5-9
5.5.2 Configuring digital output settings	5-12
5.5.3 Configuring alarm settings	5-13
5.6 Performing Configuration	5-14
5.6.1 Bank operation	5-14

5.1 Reading and Writing the Settings

5.1 Reading and Writing the Settings

Settings can be written to sensors from **HL-G2 Configuration Tool** and can also be read from sensors into **HL-G2 Configuration Tool**.



- Before writing or reading settings, make sure that the PC and sensor can communicate with each other correctly.

5.1.1 Reading the settings

This section explains how to read settings from sensors into **HL-G2 Configuration Tool**.

1 2 Procedure

1. In the "Device list" window, select a desired sensor from which settings are to be read.

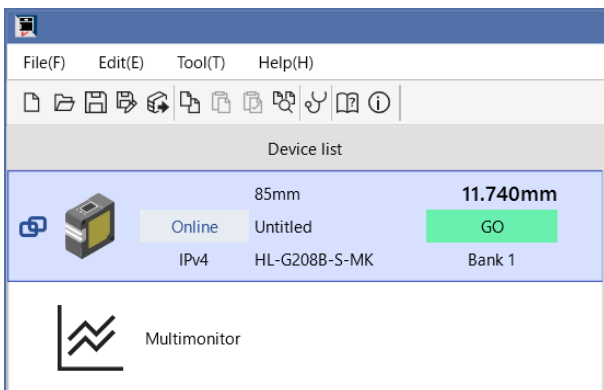

2. Click the [Read] button.

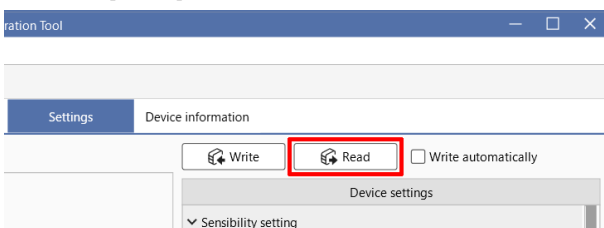

3. A confirmation message will be displayed. If you click [Yes], settings will be read from the sensor into **HL-G2 Configuration Tool**.

5.1.2 Writing the settings

This section explains how to write settings to sensors from **HL-G2 Configuration Tool**.

1 2 Procedure

1. In the "Device list" window, select a desired sensor to which settings are to be written.

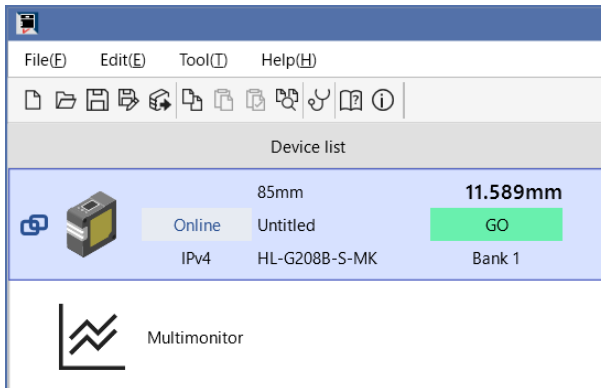

2. Click the [Write] button.

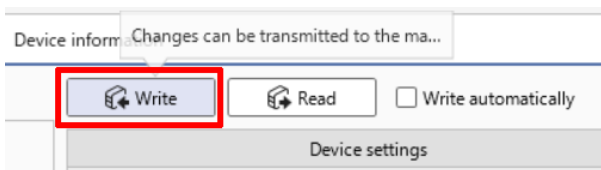

3. A confirmation message will be displayed. If you click [Yes], settings will be written to the sensor from **HL-G2 Configuration Tool**.

i Info.

- If configuration parameter settings are changed, the [Write] button will blink. In this situation, if you change the selected sensor or perform another operation to switch the window, a confirmation message will be displayed, asking whether to write settings. If you click [Yes], settings will be written to the sensor from **HL-G2 Configuration Tool**. If you click [No], the window will be switched. When the same window is displayed again, a confirmation message will be displayed, asking whether to write settings.
- If the "Write automatically" check box is selected, when a configuration parameter is changed, the changed parameter settings will be simultaneously written to the selected sensor.

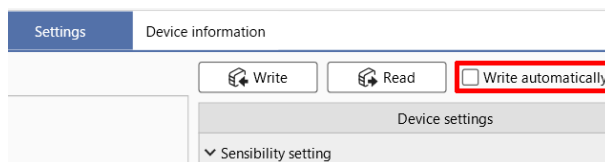

- For details on how to write settings that are configured offline when the PC does not communicate with any sensor, refer to ["7.3.3 Writing settings configured offline"](#).

5.2 Adjusting Sensitivity

5.2 Adjusting Sensitivity

Brightness tuning settings for laser beams can be changed according to the measured objects. When two workpieces that significantly differ in brightness are measured, brightness tuning may stabilize accuracy. Implementing brightness tuning requires two workpieces that differ in brightness.

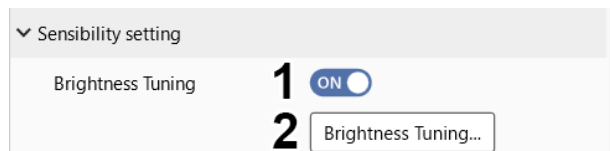

	Name	Description
1	Brightness Tuning	When turning OFF: The laser beam brightness is automatically adjusted. When turning ON: The laser beam brightness is adjusted by performing brightness tuning. When OFF is switched to ON, the brightness tuning setting window is displayed.
2	-	Clicking this button displays the brightness tuning setting window. Brightness of laser beams is adjusted using two measured objects.

5.2.1 Brightness Tuning

This section explains how to perform brightness tuning.

1 2 Procedure

1. Click the "Brightness Tuning" button with "OFF" selected to change the setting to "ON" or click the [Brightness Tuning] button.

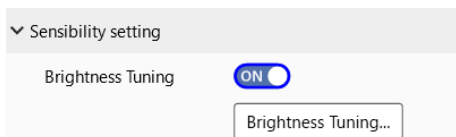

2. The "Brightness Tuning" dialog box will be displayed. Prepare two workpieces that differ in brightness. Mount the first workpiece and then click the [Register the amount of beam emission] button. "Registering" will be displayed.

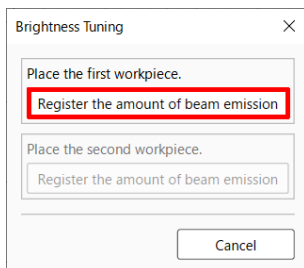

3. If the amount of beam emission is successfully registered using the first workpiece, the amount of beam emission can be registered using the second workpiece. Mount the second workpiece and then click the [Register the amount of beam emission] button. "Registering" will be displayed.

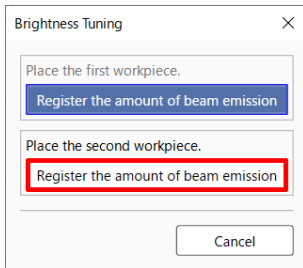

4. If the amount of beam emission is successfully registered using the second workpiece, brightness tuning will be completed. If "Brightness Tuning" is OFF, it will be switched to ON. To perform brightness tuning again, click the [Brightness tuning] button and then perform Step 2 onward.

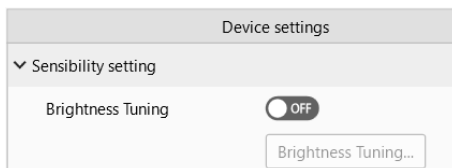

Note

- If, after the first workpiece is registered, brightness tuning is canceled, the "Brightness Tuning" will be switched to OFF.
- If brightness tuning fails, the message "Brightness tuning failed. Check the condition of the sensor or communication." will be displayed. Check whether any of the following causes is applicable, and then perform brightness tuning again.
 - The sensor is in an alarm state.
 - The measured value is in an indeterminate state.
 - Hold mode is set to anything other than "None".
 - Trigger input is set to "ON".
 - Laser Stop is in "ON" state.

5.3 Configuring Measurement Settings

5.3 Configuring Measurement Settings

The following window allows the user to set the inversion of measured value in the positive or negative direction, sampling cycle, and average count according to the shape of the measured object or application.

▼ Measurement settings

Inversion of Measured Value **1** OFF

Sampling period **2** 1 ms

Average Times **3** 1

	Name	Description
1	Inversion of Measured Value ^(Note 1)	ON: Implements a mirror inversion of the measured value at 0 mm as its base OFF: Displays measured values as normal
2	Sampling period	This drop-down list allows the user to set a desired sampling cycle according to the moving speed of the workpiece.
3	Average Times	This drop-down list allows the user to set a moving average count. When measured values are unstable, they can be stabilized by increasing the average count.

(Note 1) When configuring the sensor unit, "±Inversion" is displayed.

5.4 Configuring Correction Settings

The following window allows the user to specify how to correct and hold measured values according to the shape of the measured object or application.

Correction settings

1 Span 1.0000

2 Offset 0.000 mm

3 Zero Setting Zero Setting...

4 Hold Mode None

5 Trigger Mode Hold One-shot

	Name	Description
1	Span	This field is used to set a span (coefficient) that multiplies the measured value.
2	Offset	This field is used to set an offset correction value that is added to the measured value.
3	Zero Setting	Clicking this button sets or cancels a zero setting correction value that assumes the current measured value as "zero".
4	Hold Mode	This drop-down list allows the user to select how to hold measured values according to the measurement method for detected objects.
5	Trigger Mode	This option allows the user to select a hold setting method when trigger input is ON or OFF.

Note

- Clicking the [Zero Setting] button displays the "Zero Set Setting" dialog box.

Zero Set Setting

Measured value 0.6155 mm

Zero setting correction value -2.0490 mm

Zero Setting

Clear

Close

Clicking the [Zero Setting] button in the "Zero Set Setting" dialog box sets a zero setting correction value that assumes the current measured value as zero. Clicking the [Clear] button clears the set zero setting correction value.

5.5 Configuring Operation Settings

5.5 Configuring Operation Settings

The following window allows the user to set thresholds, digital output, and alarms.

▼ Operation setting

▼ Threshold

HIGH Set Value **1** mm

LOW Set Value **2** mm

Teaching **3**

Hysteresis **4** mm

▼ Output Delay Timer

Timer Select **5** ▼

Timer Setting **6** ms

▼ Alarm

Alarm Delay Count **7**

Alarm Digital Output **8** Alarm
 Hold previous value

(Note 2)

	Name	Description
1	HIGH Set Value	This field is used to set an upper threshold value.
2	LOW Set Value	This field is used to set a lower threshold value.
3	Teaching	Clicking this button performs teaching that sets HIGH and LOW set values. For details, refer to "5.5.1 Teaching".
4	Hysteresis	This field is used to set a hysteresis value.
5	Timer Select	This drop-down list allows the user to set control output timing. For details, refer to "5.5.2 Configuring digital output settings".
6	Timer Setting ^(Note 1)	This field is used to set a timer time value. For details, refer to "5.5.2 Configuring digital output settings".
7	Alarm Delay Count	This field is used to set the number of delays that triggers notification output when an alarm state is detected. For details, refer to "5.5.3 Configuring alarm settings".
8	Alarm Digital Output	This field is used to set an output method to be used when an alarm state is detected. For details, refer to "5.5.3 Configuring alarm settings".

(Note 1) "Timer Setting" can be set when "On Delay", "Off Delay", or "One Shot" is selected in the "Timer selection" drop-down list.

(Note 2) For the setting range and set value conditions of each parameter, refer to the *HL-G2 Series User's Manual (Communication Type)*.

5.5.1 Teaching

Using the teaching function enables LOW and HIGH set values to be set automatically. Select a desired teaching method from "1-point teaching", "2-point teaching", and "3-point teaching".

Operation setting

Threshold

HIGH Set Value mm

LOW Set Value mm

Teaching

Hysteresis mm

Name	Description	Reference section
1-point teaching	This method determines a LOW set value and HIGH set value according to the measured value and tolerance setting of the master workpiece.	"1-point teaching"
2-point teaching	This method determines a LOW set value and HIGH set value by using two types of workpiece that are used as LOW reference and HIGH reference.	"2-point teaching"
3-point teaching	This method determines a LOW set value and HIGH set value by using three types of workpiece that are used as LOW reference, GO reference, and HIGH reference.	"3-point teaching"

1-point teaching

This section explains how to set a LOW set value and HIGH set value by using a master workpiece.

1 2 Procedure

1. Select "1-point teaching" from the drop-down list.

Teaching

Determine the LOW Set Value and HIGH Set Value using the master workpiece.
HIGH Set Value: Measured value + Tolerance
LOW Set Value: Measured value - Tolerance

2. Enter a tolerance (\pm) to be set.

Master workpiece measurement

Tolerance(\pm) mm

Measured value mm

3. With the master workpiece measured, click the [Fix measured value] button. Set "HIGH Set Value" for a fixed measured value to which the tolerance is added and "LOW Set Value" for a fixed measured value from which the tolerance is subtracted.

5.5 Configuring Operation Settings

Master workpiece measurement

Tolerance(±) mm

Measured value mm

Note

- Be sure to set "Tolerance" to a value larger than "Hysteresis".
- After fixing the measured value, you can manually correct the respective values of "HIGH Set Value" and "LOW Set Value".
- Clicking the [Clear] button restarts updating the measured value.
- Clicking the [Reset] button restores the tolerance to its default value and restarts updating the measured value.

4. Click the [Use] button to apply the teaching results to the configuration parameters.

2-point teaching

This section explains how to set a LOW set value and HIGH set value by using target workpieces.

1 2 Procedure

1. Select "2-point teaching" from the drop-down list.

Teaching

Determine the LOW Set Value and HIGH Set Value using the target workpieces.
HIGH Set Value: Larger one of measured values of the first and second workpieces
LOW Set Value: Smaller one of measured values of the first and second workpieces

2. Measure a workpiece and click the [Fix measured value] button in the "First workpiece" section.

First workpiece

Measured value mm

3. Measure another workpiece and click the [Fix measured value] button in the "Second workpiece" section. Set the larger one of the two measured values as "HIGH Set Value" and the smaller one as "LOW Set Value".

Second workpiece

Measured value 11.740 mm

Fix measured value

Clear

Note

- After fixing the measured value, you can manually correct the respective values of "HIGH Set Value" and "LOW Set Value".
- Clicking the [Clear] button for each workpiece restarts updating the measured value for that workpiece.
- Clicking the [Reset] button restarts updating the measured values for both workpieces.

4. Click the [Use] button to apply the teaching results to the configuration parameters.

Reset

Use Cancel

3-point teaching

This section explains how to set a LOW set value and HIGH set value by using three types of workpiece.

1 2 Procedure

1. Select "3-point teaching" from the drop-down list.

Teaching

3-point teaching ▾

Determine the LOW Set Value and HIGH Set Value using three types of the workpieces.
 HIGH Set Value: Average of measured values of the first and second workpieces
 LOW Set Value: Average of measured values of the second and third workpieces

2. Measure a workpiece to be used as HIGH reference and click the [Fix measured value] button in the "First workpiece" section.

First workpiece (HIGH)

Measured value 11.740 mm

Fix measured value

Clear

3. Measure a workpiece to be used as GO reference and click the [Fix measured value] button in the "Second workpiece" section.

Second workpiece (GO)

Measured value 11.739 mm

Fix measured value

Clear

5.5 Configuring Operation Settings

4. Measure a workpiece to be used as LOW reference and click the [Fix measured value] button in the "Third workpiece" section.

Third workpiece (LOW)

Measured value 11.739 mm

Fix measured value

Clear

Under the following conditions, set "HIGH Set Value" and "LOW Set Value".

- HIGH Set Value = (Measured value of first workpiece + Measured value of second workpiece)/2
- LOW Set Value = (Measured value of second workpiece + Measured value of third workpiece)/2

Note

- After fixing the measured value, you can manually correct the respective values of "HIGH Set Value" and "LOW Set Value".
- Clicking the [Clear] button for each workpiece restarts updating the measured value for that workpiece.
- Clicking the [Reset] button restarts updating the measured values for all workpieces.

5. Click the [Use] button to apply the teaching results to the configuration parameters.

Reset

Use Cancel

5.5.2 Configuring digital output settings

You can set control output timing and a timer time value. From the "Timer Select" drop-down list, select one of the timer setting methods shown in the table below.

Output Delay Timer

Timer Select On Delay

Timer Setting 5 ms

Setting item	Operation
OFF (No timer)	No change is made in the control output timing.
On Delay	When control output is switched from OFF to ON, ON output is delayed by the specified timer time value.
Off Delay	When control output is switched from ON to OFF, OFF output is delayed by the specified timer time value.
One Shot	When control output is switched from OFF to ON, ON is held for the specified timer time value and then OFF is output.
Hold	Output signals are held from when an object is detected until measured value reset input turns ON.

"Timer Setting" can be set when "On Delay", "Off Delay", or "One Shot" is selected in the "Timer selection" drop-down list.

Note

- The setting range for "Timer Setting" is 1 ms to 100 ms.
- The set timer time value is shared by all timer settings.

5.5.3 Configuring alarm settings

You can set a delay count at alarm occurrence and an alarm output method.

From the "Alarm Delay Count" item, set the number of delays that triggers notification output when an alarm state is detected.

▼ Alarm

Alarm Delay Count

Alarm Digital Output Alarm

Hold previous value

Note

- The setting range for "Alarm Delay Count" is from 0 to 65535.

From the "Alarm Digital Output" item, set an output method to be used when an alarm state is detected.

Setting item	Operation
Alarm	The measured value is hidden. In the display section of the sensor, "ALARM" is displayed.
Hold previous value	Holds and displays a value that is measured immediately before an alarm state is detected

5.6 Performing Configuration

5.6 Performing Configuration

You can set banks to/from which measurement conditions or judgment criteria are written or read, a display method for the main display section, and key lock.

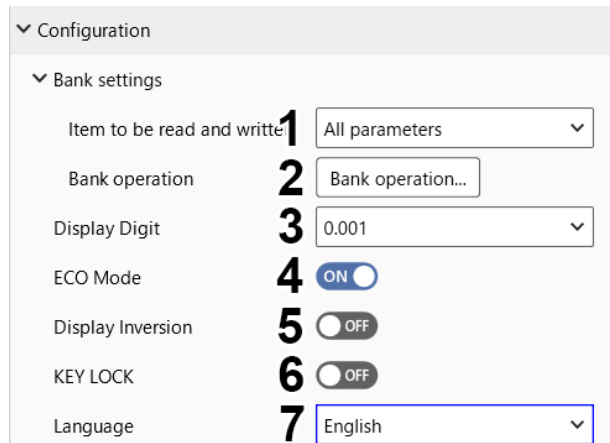

Configuration

Bank settings

Item to be read and written **1** All parameters

Bank operation **2** Bank operation...

Display Digit **3** 0.001

ECO Mode **4** ON

Display Inversion **5** OFF

KEY LOCK **6** OFF

Language **7** English

	Name	Description
1	Item to be read and written	This drop-down list allows the user to set items to be written to or read from banks.
2	Bank operation	Clicking this button allows the user to select a bank and write or read data to/from the bank.
3	Display Digit	This drop-down list allows the user to set the number of digits after the decimal point in the main display section.
4	ECO Mode	ON: Turns OFF the main display section unless keys are operated OFF: Turns ON the main display section at all times
5	Display Inversion	ON: Displays the main display section upside down OFF: Displays the main display section as normal
6	KEY LOCK	ON: Disables key operation OFF: Enables key operation as normal
7	Language	This option allows the user to select a display language to be used in the main display section.

5.6.1 Bank operation

This section explains how to write and read data to/from banks.

1 2 Procedure

1. Check whether the correct item is selected in the "Item to be read and written" drop-down list and then click the [Bank operation] button.

The screenshot shows a configuration window with a tree view. Under 'Configuration', 'Bank settings' is expanded. It contains two fields: 'Item to be read and written' with a dropdown menu set to 'All parameters', and 'Bank operation' with a button labeled 'Bank operation...' highlighted by a red rectangle.

2. Select a target bank (1 to 4).

The screenshot shows a 'Bank operation' dialog box. It has a title bar with a close button. Inside, there are two labels: 'Target bank' with a dropdown menu set to 'Bank 1' (highlighted by a red rectangle), and 'Target item' with the text 'All parameters'. At the bottom, there are three buttons: 'Read', 'Write', and 'Cancel'.

3. Click [Write] to write data to the bank or [Read] to read data from the bank.

This screenshot is identical to the previous one, but the 'Read' and 'Write' buttons at the bottom are highlighted with a red rectangle.

4. A confirmation dialog box will be displayed. Clicking [Yes] executes write or read processing.

(MEMO)

6 Setting up Ethernet Communication

6.1 Configuring IP Settings	6-2
6.1.1 Configuring sensor IP settings	6-2
6.1.2 IP settings for PC	6-3
6.2 Configuring SLMP Settings.....	6-5
6.2.1 Client communication setting	6-6
6.2.2 Client transmission data setting	6-7
6.2.3 Client data transmission.....	6-7
6.2.4 Server communication settings.....	6-8

6.1 Configuring IP Settings

6.1 Configuring IP Settings

The "Device information" tab allows the user to change IP settings for the sensor and PC.

	Name	Description
1	IP settings	This area displays the IP settings configured for the sensor.
2	[Writing IP settings] button	Clicking this button writes the changed IP settings to the sensor. For details on how to change IP settings for sensors, refer to "6.1.1 Configuring sensor IP settings".
3	[PC IP settings] button	Clicking this button displays the IP settings configured on the PC. The IP settings on the PC can also be changed. For details, refer to "6.1.2 IP settings for PC".

Note

The default values of each IP setting item are shown below.

IP address: 192.168.1.6

Subnet mask: 255.255.255.0

Default gateway: 192.168.1.1

Port No.(Tool): 49152

Port No.(Modbus): 502

6.1.1 Configuring sensor IP settings

This section explains how to change IP settings for sensors.

1.2 Procedure

1. In the "Device list" window, select a sensor for which IP settings are to be changed.

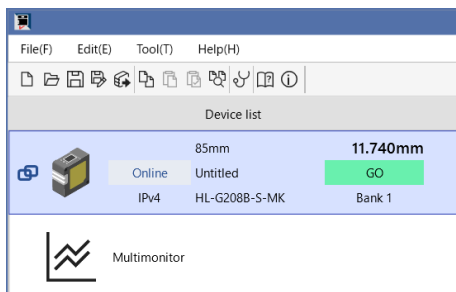

2. Make the necessary change to the IP settings for the sensor.

IP settings	
IP Address	: 192 . 168 . 1 . 6
Subnet Mask	: 255 . 255 . 255 . 0
Default Gateway	: 192 . 168 . 1 . 1
Port No.(Tool)	: 49152
Port No.(Modbus)	: 502
<input type="button" value="Writing IP settings"/>	
<input type="button" value="PC IP settings..."/>	

3. Click the [Writing IP settings] button.

IP settings	
IP Address	: 192 . 168 . 1 . 6
Subnet Mask	: 255 . 255 . 255 . 0
Default Gateway	: 192 . 168 . 1 . 1
Port No.(Tool)	: 49152
Port No.(Modbus)	: 502
<input type="button" value="Writing IP settings"/>	
<input type="button" value="PC IP settings..."/>	

4. A confirmation message will be displayed. Clicking [Yes] applies the change to the IP settings for the sensor.

Note

If writing the IP settings has failed, check whether any of the following causes is applicable.

- An error has occurred on the sensor or communication.
- The default gateway does not exist in the same network segment (subnet) as the one defined by the IP address and subnet mask.
- The IP address or default gateway is set to 0.0.0.1- 0.255.255.255, 127.0.0.0-127.255.255.255, or 224.0.0.0-224.255.255.255.
- All bits in the host address segment of the IP address or default gateway are set to 0.
- All bits in the host address segment of the IP address or default gateway are set to 1.
- The subnet mask does not consist of consecutive bits.
- The port number is identical with the port number for Modbus.
- The port number is 44818.

6.1.2 IP settings for PC

This section explains how to change IP settings for PC.

1 2 Procedure

1. Click the [PC IP settings] button.

6.1 Configuring IP Settings

IP settings

IP Address	:	192 . 168 . 1 . 6
Subnet Mask	:	255 . 255 . 255 . 0
Default Gateway	:	192 . 168 . 1 . 1
Port No.(Tool)	:	49152
Port No.(Modbus)	:	502

Writing IP settings

PC IP settings...

2. Make the necessary changes to the settings in the "PC IP settings" window.

PC IP settings

Adapter	▼
IP Address	192 . 168 . 1 . 10
Subnet Mask	255 . 255 . 255 . 0
Default Gateway	192 . 168 . 1 . 1

OK Cancel

3. Click [OK].

PC IP settings

Adapter	▼
IP Address	192 . 168 . 1 . 10
Subnet Mask	255 . 255 . 255 . 0
Default Gateway	192 . 168 . 1 . 1

OK Cancel

4. A confirmation message will be displayed. Clicking [Yes] applies the change to the IP settings for the PC.

i Info.

- The "User Account Control" confirmation window may be displayed. In such a case, click [Yes] to proceed with the change procedure.

6.2 Configuring SLMP Settings

This section explains how to change SLMP settings.

1 2 Procedure

1. Select the "Device information" tab and click the [SLMP settings] button to display the "SLMP settings" window.

The screenshot shows the 'Device information' tab for an HL-G2 device. It displays various fields such as Label, Model No. (HL-G208B-S-MK), Interface (IPv4), Serial No. (3DDZ0045), System version (00.A3.00.27), and Measurement type (85mmWidth type). At the bottom, there are three buttons: 'Initialize the sensor', 'Initializing bank', and 'SLMP settings', with the latter being highlighted by a red rectangular box.

2. Change the SLMP settings. For details on the setting items, refer to the following sections.
 - "6.2.1 Client communication setting"
 - "6.2.2 Client transmission data setting"
 - "6.2.3 Client data transmission"
 - "6.2.4 Server communication settings"
3. Clicking [Write] writes the changed settings to the sensor.

The screenshot shows the 'SLMP settings' dialog box with four tabs: 'Client communication setting', 'Client transmission data setting', 'Client data transmission', and 'Server communication setting'. The 'Client communication setting' tab is active, showing fields for Request destination IP address (192 . 168 . 1 . 100), Request destination port No. (45237), Request destination processor number (0x03FF: Default processor), Request destination network number (0), Specify 1-239, Request destination station number (255), Specify 1-120, Request source port No. (45238), Write interval (500 ms), and Automatic writing after starting (checked). At the bottom right, the 'Write' button is highlighted with a red rectangular box.

i Info.

- If there is any problem with the sensor being configured or the communication status, you will be exited from the configuration with a warning message.
- Clicking [Write] writes all the changed information including the information changed in tabs other than the selected tab to the sensor.

6.2 Configuring SLMP Settings

6.2.1 Client communication setting

The following window allows the user to check and change communication settings for sensors (clients).

	Name	Description
1	Communication settings	These items are used to set communication parameters for the client.
2	Write interval ^(Note 1)	This field is used to set an interval at which data is written to the server.
3	Automatic writing after starting	ON: Starts writing data automatically after startup OFF: Starts writing data at any desired timing

(Note 1) The setting range of "Write interval" is 50 ms to 10000 ms (in increments of 10 ms). The default value is 500 ms.

The setting range and default value of each communication setting parameter are shown below.

Parameter name	Setting range	Default value
Request destination IP address	0.0.0.1 to 255,255,255,255	192.168.1.100
Request destination port No.	1 to 65535	45237
Request destination processor number	0x03FF: Default processor 0x03D0: Control system processor 0x03D1: Standby system processor 0x03D2: A-system processor 0x03D3: B-system processor 0x03E0: Multiprocessor 1 0x03E1: Multiprocessor 2 0x03E2: Multiprocessor 3 0x03E3: Multiprocessor 4	0x03FF: Default processor
Request destination network number	0, 1-239	0
Request destination station number	When "Request destination network number" is "0": "255"	255 ^(Note 1)

Parameter name	Setting range	Default value
	When "Request destination network number" is "1-239": "1-120", "125", "126"	
Request source port No.	1 to 65535	45238

(Note 1) When "Request destination network number" is "1-239", the default value is "1-120".

6.2.2 Client transmission data setting

The following window allows the user to check and change settings for data transmission from sensors (clients).

The screenshot shows the 'SLMP settings' window with the 'Client transmission data setting' tab selected. The 'Starting register No.' is set to 1 and the 'Ending register No.' is set to 2. The 'Transmission parameter' section has several checkboxes, with 'Measured value' being the first one. The 'Write' and 'Cancel' buttons are located at the bottom right of the window.

	Name	Description
1	Starting register No.	This field is used to set a starting register number.
2	Ending register No.	An ending register number is automatically set according to the starting register number and transmission parameter settings.
3	Transmission parameter	This area allows the user to select a type of parameters to be written.

6.2.3 Client data transmission

Data can be sent from a sensor (client) to its host device (server).

6.2 Configuring SLMP Settings

SLMP settings

Client communication setting Client transmission data setting **Client data transmission** Server communication setting

1 Data transmitting state Writing suspended

2 Data transmission writing Remote RUN

3 Data transmission writing Remote STOP

Write Cancel

	Name	Description
1	Data transmitting state	This item indicates the current data transmission state. "Writing suspended": Indicates the state in which "Automatic writing after starting" is set to OFF and writing is suspended "Writing in progress": Indicates the state in which "Automatic writing after starting" is set to OFF and writing is in progress "Automatic writing in progress": Indicates the state in which "Automatic writing after starting" is set to ON and writing is in progress
2	[Remote RUN]button	Clicking this button starts writing when writing is suspended.
3	[Remote STOP]button	Clicking this button stops writing when writing is in progress.

6.2.4 Server communication settings

The following window allows the user to check and change the main unit settings when the HL-G2 is used as a server.

SLMP settings

Client communication setting Client transmission data setting Client data transmission **Server communication setting**

1

Port No. 45237

Network No. 0

Specify 1-239 1

Node No. 255

Specify 1-120 1

Write Cancel

6.2 Configuring SLMP Settings

	Name	Description
1	Communication settings	This window allows the user to set up communication parameters for the server.

The setting range and default value of each communication setting parameter are shown below.

Parameter name	Setting range	Default value
Port No.	1 to 65535 ^(Note 1)	45237
Network No.	0, 1-239	0
Node No.	When "Network No." is "0": "255" When "Network No." is "1-239": "1-120", "125", "126".	255 ^(Note 2)

(Note 1) "2222", "9090", "44818", and the port No. used for the client function cannot be set.

(Note 2) When "Network No." is "1-239", the default value is "1-120".

(MEMO)

7 Using Convenient Functions

7.1 Monitoring Multiple Sensors.....	7-2
7.1.1 Multimonitor display window	7-4
7.2 Setting Labels to Sensors	7-7
7.3 Configuring Settings Offline	7-8
7.3.1 Creating a new configuration file.....	7-8
7.3.2 Opening a configuration file	7-9
7.3.3 Writing settings configured offline	7-9
7.4 Copying Settings.....	7-11
7.4.1 Pasting settings.....	7-12
7.4.2 Selecting and pasting settings	7-12
7.5 Comparing Settings	7-15
7.6 Protecting Settings.....	7-17
7.6.1 Setting a password	7-17
7.6.2 Canceling a password.....	7-18
7.6.3 Initializing a password.....	7-19
7.7 Initializing Settings	7-21
7.7.1 Initialize Sensor.....	7-21
7.7.2 Initialize Bank.....	7-22

7.1 Monitoring Multiple Sensors

7.1 Monitoring Multiple Sensors

This section explains how to use the "Multimonitor" function, which monitors multiple sensors in the Monitor window.

1 2 Procedure

1. Select "Multimonitor" in the "Device list" window.

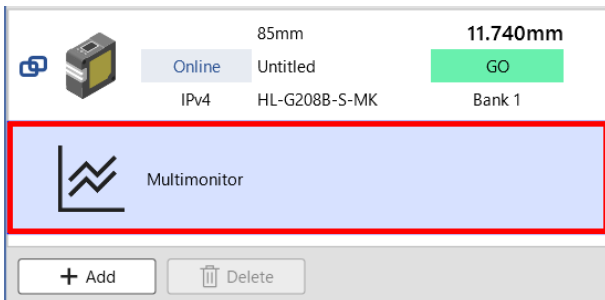

2. Drag multiple sensors to be monitored simultaneously and drop them into the "Monitor" tab.

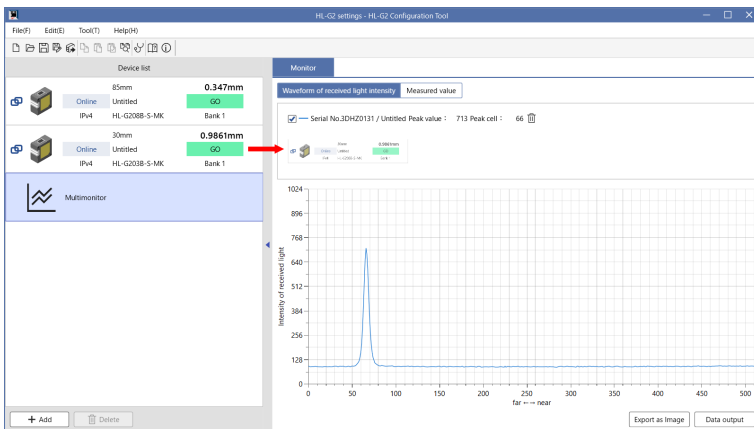

3. The received light intensities and measured values of each sensor that was dragged and dropped will be displayed.

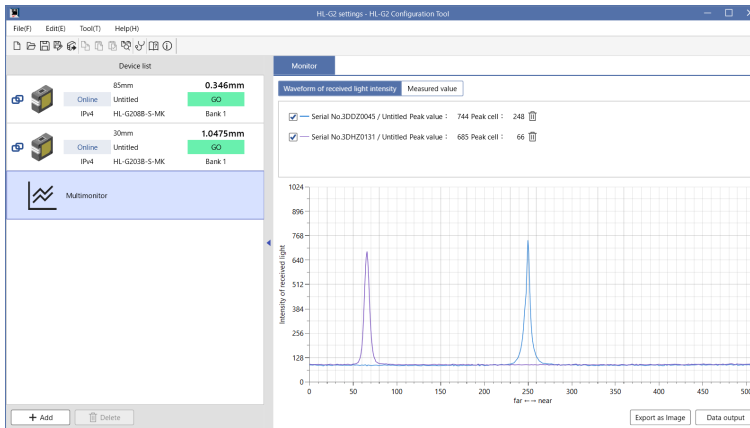

Note

- The Multimonitor function can monitor and display up to eight sensors.
- The Multimonitor function cannot log measured values for serial communication type sensors.
- To remove a sensor from the Multimonitor function, click the recycle bin icon on the right side of the sensor.

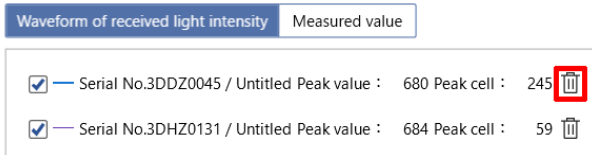

7.1 Monitoring Multiple Sensors

7.1.1 Multimonitor display window

■ Multimonitor for received light intensity waveforms

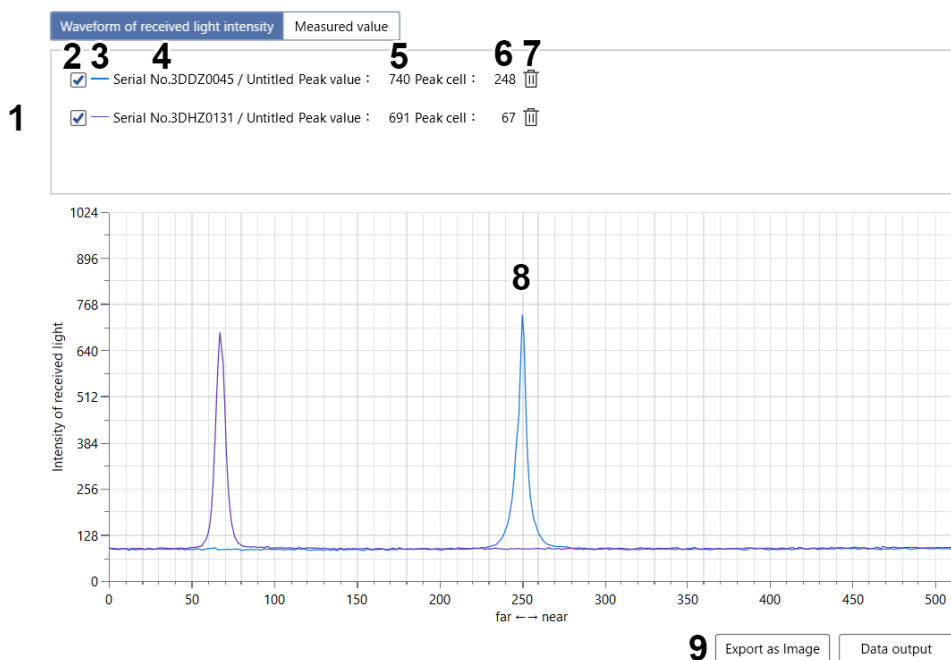

	Name	Description
1	Legend	This is a list of monitored sensors. Sensors are displayed in the order in which they are shown in the "Device list" window.
2	Show/hide check box	Graphs are displayed for sensors for which the check box is selected. Graphs are not displayed for sensors for which the check box is canceled.
3	Line color	Display color of graph line
4	Sensor information	Serial number and label of sensor
5	Peak value	Maximum value of received light intensity waveforms
6	Peak cell	Cell position of peak value
7	[Delete legend]button	Clicking this button removes the sensor from the legend.
8	Received light intensity waveform	This graph is drawn by plotting received light intensities and cell positions.
9	Export as Image Data output	Use these buttons to output received light intensity waveforms to a file. Clicking the "Data output" button outputs all graphs of the sensors for which the show/hide check box is selected. For details, refer to "4.5.3 Export as Image / Data output".

■ Multimonitoring measured values

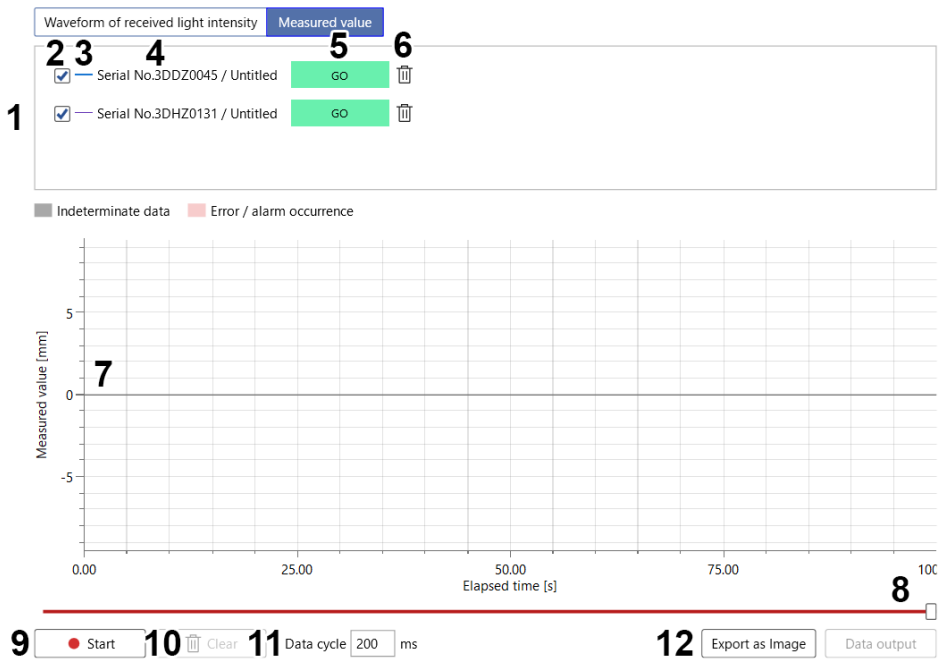

	Name	Description
1	Legend	This is a list of monitored sensors. Sensors are displayed in the order in which they are shown in the "Device list" window.
2	Show/hide check box	Graphs are displayed for sensors for which the check box is selected. Graphs are not displayed for sensors for which the check box is canceled.
3	Line color	Display color of graph line
4	Sensor information	Serial number and label of sensor
5	Output state	This section indicates the output state of the sensor. For details, refer to "4.4.3 Output state".
6	[Delete legend]button	Clicking this button removes the sensor from the legend.
7	Measured value graph	This graph is drawn by plotting measured values and elapsed time. The display area can be zoomed in or zoomed out by rotating the mouse wheel while the mouse pointer is within the display area. The display area can also be zoomed in or zoomed out at low speed by rotating the mouse wheel while holding down the <Ctrl>key.
8	Slider	This slider allows the user to change the display range of measured value graphs.
9	[Start]button [Pause]button [Resume]button	This button allows the user to perform logging to continue collecting measured values in any desired time cycle. <ul style="list-style-type: none"> Clicking the "Start" button before the start of logging starts logging. The button display will be changed as follows:Start>Pause. Clicking the "Pause" button during logging pauses logging. The button display will be changed as follows:Pause>Resume.(Note 2) Clicking the "Resume" button during paused logging resumes logging. The button display will be changed as follows:Resume>Pause.

7.1 Monitoring Multiple Sensors

	Name	Description
10	[Clear]button	This button allows the user to erase logged results. If you click the[Clear]button and then[Yes]in the confirmation message window, you can erase the logged results and start new logging.
11	Data cycle	This section indicates the time cycle in which measured values are to be collected by logging. The minimum settable value is 10 ms and the maximum settable value is 400 ms. (Note 3)
12	Export as Image Data output	Use these buttons to output the measured values that have been logged to a file. Clicking the "Data output" button outputs all graphs of the sensors for which the show/hide check box is selected. For details, refer to" 4.5.3 Export as Image / Data output ".

(Note 1) The maximum allowable number of measurement times per logging is 60,000.

(Note 2) Logged data is not saved at the time of pause. For details on how to save logged data, refer to"[4.5.3 Export as Image / Data output](#)".

(Note 3) By default, the data cycle is set to 200 ms.

7.2 Setting Labels to Sensors

This section explains how to set label names to identify each sensor easily.

1 2 Procedure

1. In the "Device list" window, select a sensor for which a label is to be set and click the "Device information" button.

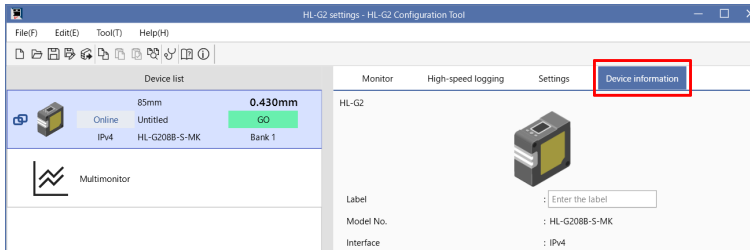

2. In the "Label" field, enter any desired label name.

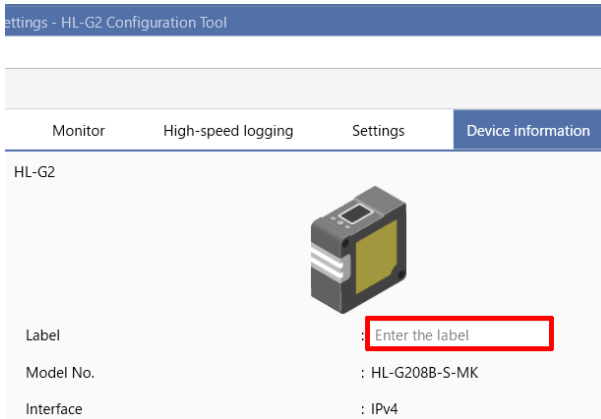

Note

- The maximum number of characters for a label name is 30.
3. After entering a label name, press the <Enter> key. A confirmation message will be displayed. Click [Yes].
 4. The entered label name will be displayed in any window where labels are displayed.

7.3 Configuring Settings Offline

7.3 Configuring Settings Offline

Sensor settings can be configured using **HL-G2 Configuration Tool** even if the PC does not communicate with the sensor (offline).

7.3.1 Creating a new configuration file

This section explains how to create a new configuration file.



- If a sensor has been added to the "Device list" window, a confirmation message will be displayed, asking whether to save the configuration file. If you must save the configuration file, click [Yes]. If you click [No], the changed settings will be discarded.

1 2

Procedure

1. On the menu bar, select **File>New**. Alternatively, select "Create a new file" in the "Start menu" window displayed when **HL-G2 Configuration Tool** is started, and then click [Start].

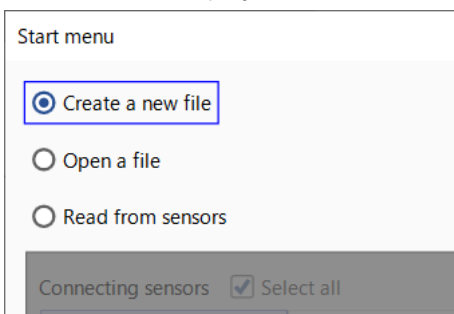

2. The "Add sensors" window will be displayed. Select a desired sensor and click [Add]. The selected sensor will be added to the "Device list" window. Clicking [Cancel] empties the "Device list" window.

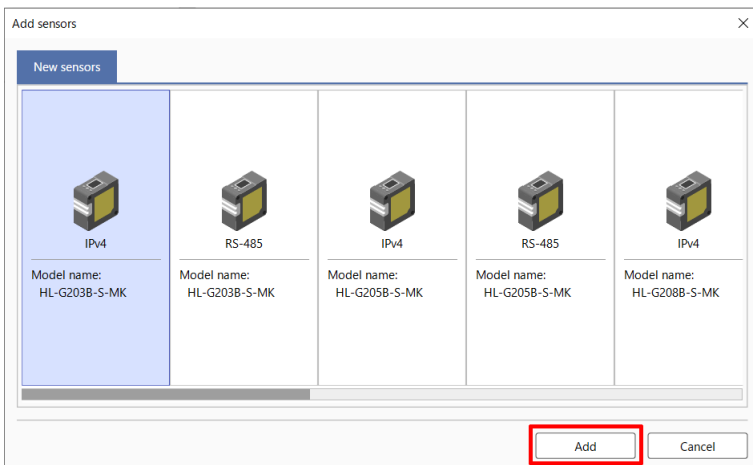

Note

- For details on how to add more sensors, refer to "4.4.4 Adding sensors".

7.3.2 Opening a configuration file

This section explains how to open a saved configuration file in **HL-G2 Configuration Tool**.



- If a sensor has been added to the "Device list" window, a confirmation message will be displayed, asking whether to save the configuration file. If you must save the configuration file, click [Yes]. If you click [No], the changed settings will be discarded.

1 2

Procedure

1. On the menu bar, select **File>Open**. Alternatively, select "Open a file" in the "Start menu" window displayed when **HL-G2 Configuration Tool** is started, and then click [Start].

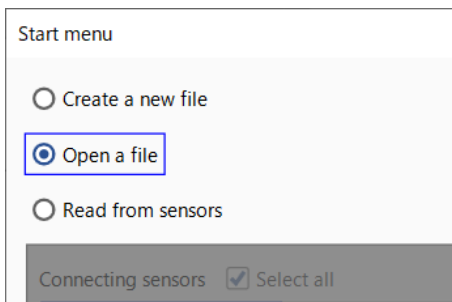

2. Select a saved configuration file and open it.

Note

- When a configuration file is opened, each sensor in the "Device list" window enters the "Disconnection" state.

7.3.3 Writing settings configured offline

This section explains how to write settings configured or edited offline to a sensor.

1 2

Procedure

1. In the "Device list" window, click the [Connection] button for the sensor to which settings are to be written.

7.3 Configuring Settings Offline

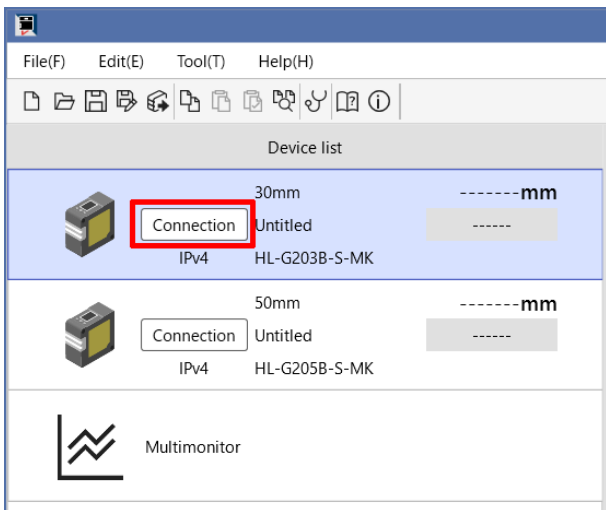

2. Connected sensors will be displayed. Select the sensor to which settings are to be written and then click [Finalize].

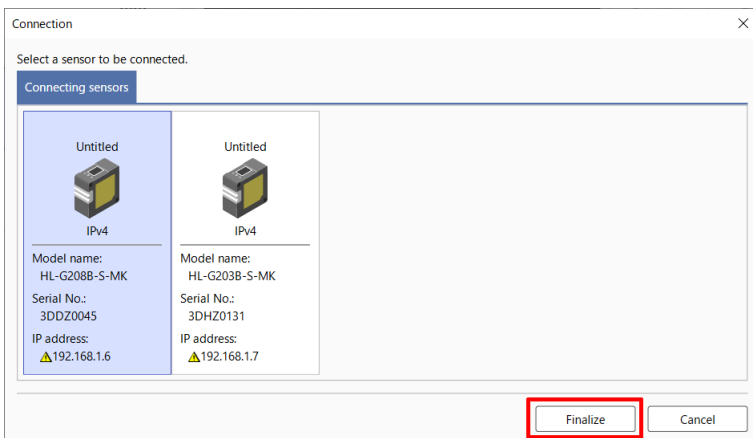

i Info.

- You cannot select a sensor whose model does not agree with the settings.

3. A confirmation message will be displayed, asking whether to write the settings. Click [Yes].
4. The settings will be written to the sensor, which will then enter a connection state.

7.4 Copying Settings

This section explains how to copy settings configured for one sensor to apply them to another sensor.

1 2 Procedure

1. In the "Device list" window, select a sensor from which settings are to be copied.

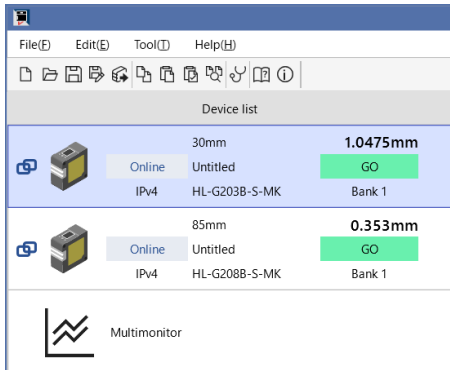

2. Copy settings using one of the following methods.

- Shortcut keys: Press the <Ctrl>+<C> keys.
- Right-click and then select [Copy] from the context menu that appears.
- On the menu bar, select **Edit>Copy**.
- Click the [Copy] icon on the Quick Access Toolbar.

The sensor from which settings are being copied will be surrounded by a dotted line frame.

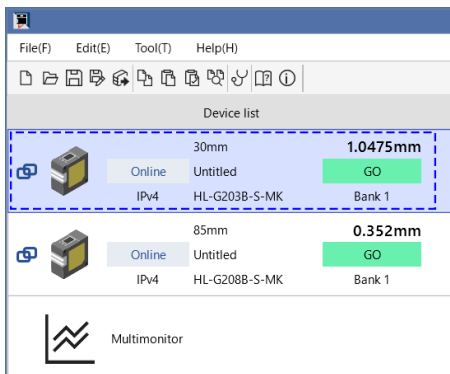

For details on how to apply copied sensor settings to another sensor, refer to "7.4.1 Pasting settings" or "7.4.2 Selecting and pasting settings".

Note

- The following settings cannot be copied.
 - Brightness tuning settings
 - Zero setting correction value
 - Bank settings

7.4 Copying Settings

7.4.1 Pasting settings

This section explains how to apply (paste) copied settings to another sensor.

1 2 Procedure

1. In the "Device list" window, select a sensor to which copied settings are to be applied.

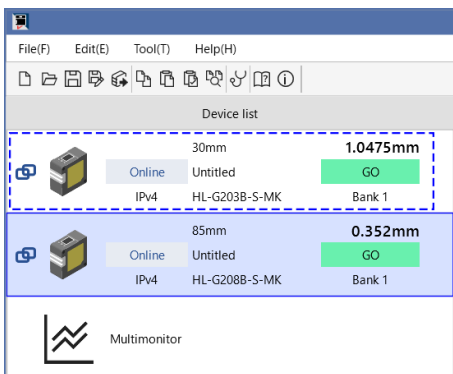

2. Paste settings using one of the following methods.
 - Shortcut keys: Press the <Ctrl>+< V> keys.
 - Right-click and then select [Paste] from the context menu that appears.
 - On the menu bar, select **Edit>Paste**.
 - Click the [Paste] icon on the Quick Access Toolbar.
3. Copied sensor settings will be applied to the selected sensor.

i Info.

- If there is any problem with settings, a message will be displayed and settings cannot be pasted. In such a case, correct the problem indicated by the message.
- If the model of the sensor from which settings are copied differs from the model of the sensor to which the settings are pasted, some settings may fall outside the scope of paste processing. In such a case, a message will be displayed, indicating parameters that cannot be applied, and only parameters that can be applied will be pasted.

7.4.2 Selecting and pasting settings

This section explains how to apply (paste) only the specified copied settings to another sensor.

1 2 Procedure

1. In the "Device list" window, select a sensor to which copied settings are to be applied.

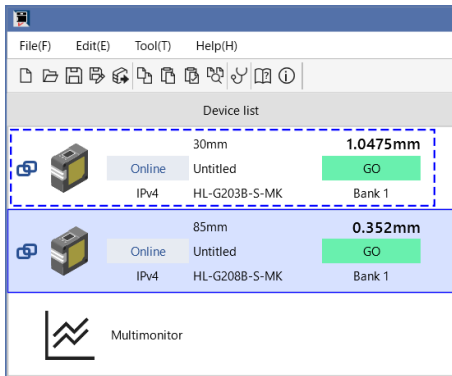

2. Open the "Select and Paste" window using one of the following methods.
 - Shortcut keys: Press the <Ctrl>+<Alt>+<V> keys.
 - Right-click and then select [Select and Paste] from the context menu that appears.
 - On the menu bar, select **Edit>Select and Paste**.
 - Click the [Select and Paste] icon on the Quick Access Toolbar.

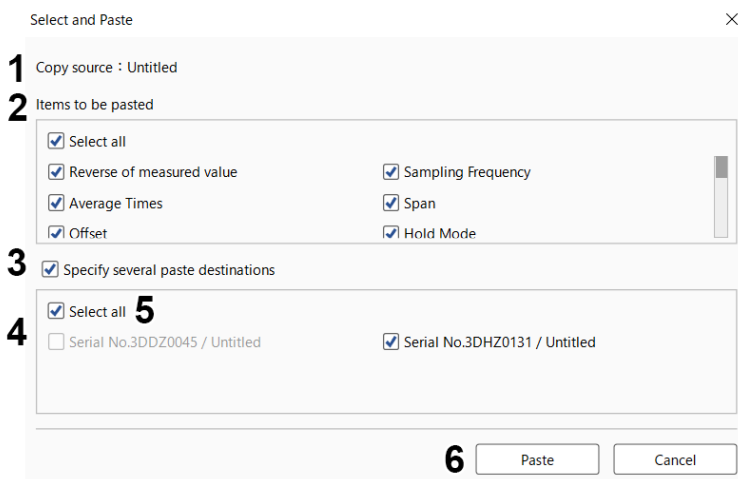

	Name	Description
1	Copy source	This section indicates the label of the sensor selected as the copy source of the settings.
2	Items to be pasted	Select the check boxes of setting items to be pasted.
3	"Specify several paste destinations" check box	Selecting this check box allows the user to select more than one sensor as paste destinations.
4	Paste destination sensors	Paste destination sensors are displayed when the "Specify several paste destinations" check box is selected. Select the check boxes of paste destination sensors.
5	"Select all" check box	Selecting this check box selects all the check boxes in the "Items to be pasted" or "Paste destination sensors" section. Canceling this check boxes cancels all the check boxes in the "Items to be pasted" or "Paste destination sensors" section.

7.4 Copying Settings

	Name	Description
6	[Paste] button	Clicking this button pastes all the setting items corresponding to the selected check boxes in the "Items to be pasted" section.

3. Select desired check boxes in the "Items to be pasted" section and "Paste destination sensors" section, and click [Paste]. Only the specified setting items among those copied from the source sensor will be applied to the selected sensor.

7.5 Comparing Settings

This section explains how to compare the settings of two sensors displayed in the "Device list" window and check for any differences in settings.

1 2 Procedure

1. Open the "Select settings to be collated" window using one of the following methods.
 - On the menu bar, select **Edit>Settings collation**.
 - Click the [Settings collation] icon on the Quick Access Toolbar.
2. Select two sensors whose settings are to be compared.

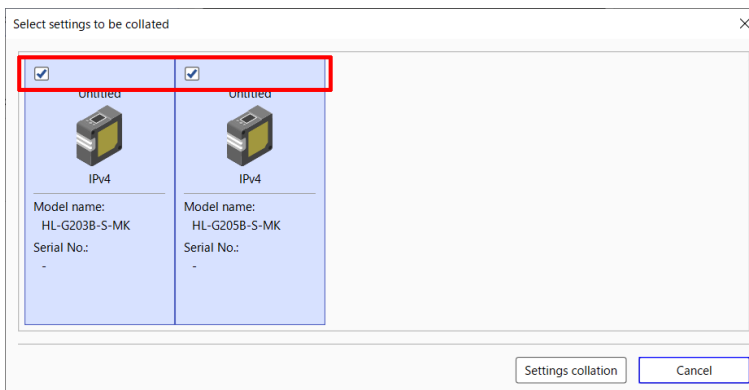

i Info.

- When the "Select settings to be collated" window is displayed, the sensor selected in the "Device list" window is automatically selected as the first sensor.
- Selecting a sensor that is connected online displays a confirmation dialog box, asking whether to load the sensor settings.
 - Click [Yes] to compare the settings in the "Settings" tab by overwriting them with the sensor settings.
 - Click [No] to compare the settings in the "Settings" tab as they are.

3. Click [Settings collation].

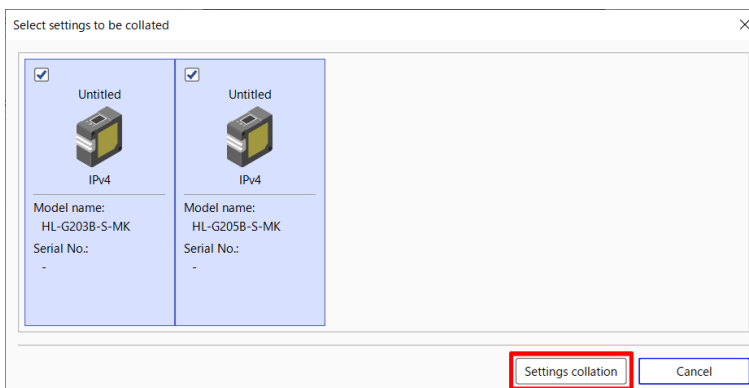

7.5 Comparing Settings

4. The settings of the two sensors will be displayed side by side. The cells with any difference in settings will be highlighted in blue.

Item	Set value	
	Untitled Serial No.-	Untitled Serial No.-
Sensibility setting		
Beam emission power adjustment AUTO	-	-
Measurement settings		
Reverse of measured value	OFF	OFF
Sampling Frequency[ms]	1	1
Average Times	512	512
Correction settings		
Span	1.0000	1.0000
Offset[mm]	0.0000	0.000
Hold Mode	None	None
Trigger Mode	Hold	Hold
Operation setting		
HIGH Set Value [mm]	5.0000	10.000
LOW Set Value [mm]	-5.0000	-10.000
Hysteresis [mm]	0.0100	0.020
Timer Select	OFF	OFF
Timer Setting[ms]	-	-
Alarm Delay Count	8	8
Alarm Digital Output	Previous value hold	Previous value hold
Configuration		
Item to be read and written	All parameters	All parameters
Display Digit	0.0001	0.001
ECO Mode	ON	ON

Close

7.6 Protecting Settings

Selecting the "Enable write lock function" check box allows the user to specify a password that is required to write settings to a sensor. Specifying a password prevents third parties who do not know the password from setting and changing any functions for the sensor.



- Strictly manage passwords to prevent set passwords from being forgotten or leaked to third parties.

7.6.1 Setting a password

This section explains how to protect sensor settings with a password by selecting the "Enable write lock function" check box.

1 2 Procedure

1. On the menu bar, select **File>Option**.
2. Select the "Enable write lock function" check box.

Option

Enable write lock function.

Set a new password

Current password

New password

New password (confirm)

OK Cancel

3. Select the "Set a new password" check box and then enter values in the "Current password" and "New password" fields. When setting a password for the first time, enter a new password only.

Option

Enable write lock function.

Set a new password

Current password

New password

New password (confirm)

OK Cancel

7.6 Protecting Settings

Note

- The number of characters that can be set as a password is fixed at four single-byte characters.
- The following characters can be used for passwords.
 - Uppercase and lowercase letters (case-sensitive)
 - Numerical characters
 - Symbols: ! " # \$ % & ' () - ^ \ @ [; :] , . / = ~ | ` { + * } < > ? _
 - Space
- We recommend that you set a secure password, which is a combination of four types of characters: uppercase letters, lowercase letters, numerical characters, and symbols (including space).

4. For confirmation, enter the same password in the "New password (confirm)" field.

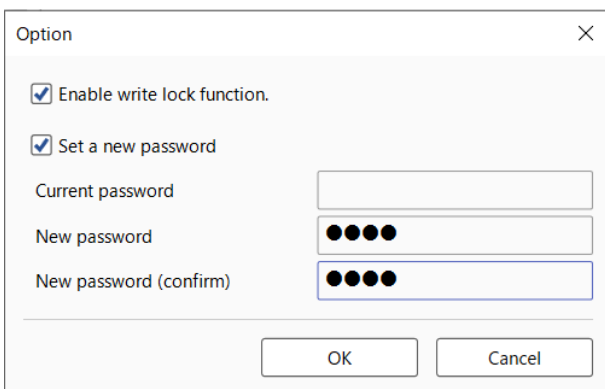

The screenshot shows a dialog box titled "Option" with a close button (X) in the top right corner. It contains two checked checkboxes: "Enable write lock function." and "Set a new password". Below these are three input fields: "Current password" (empty), "New password" (containing four black dots), and "New password (confirm)" (containing four black dots). At the bottom are "OK" and "Cancel" buttons.

5. Click[OK].

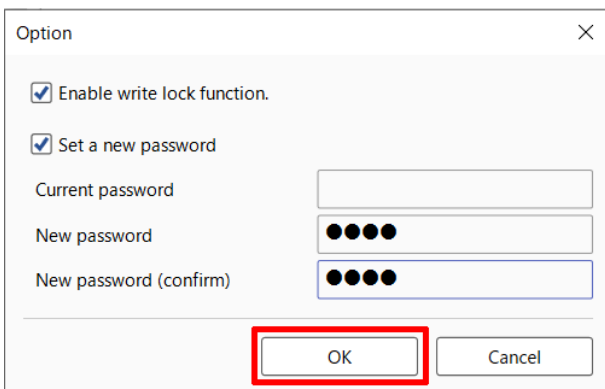

This screenshot is identical to the previous one, but the "OK" button at the bottom is highlighted with a red rectangular border.

7.6.2 Canceling a password

This section explains how to cancel a password to enable writing to the sensor.

1 2 Procedure

1. On the menu bar, select **File>Option**.
2. Cancel the "Enable write lock function" check box.

Option

Enable write lock function.

Set a new password

Current password

New password

New password (confirm)

OK Cancel

3. Enter the password and click [OK].

Password entry

Password

Initialization OK Cancel

7.6.3 Initializing a password

This section explains how to initialize a password in case you have forgotten your password.

1 2 Procedure

1. In the "Password entry" window, click [Initialization].

Password entry

Password

Initialization OK Cancel

2. The "Password initialization" dialog box will be displayed. Notify your local dealer of the code displayed in the "Request code" field. Your local dealer will notify you of a code to be entered in the "Initialization code" field.

7.6 Protecting Settings

Password initialization ×

Notify your local dealer of the request code below.

Request code

The password will be initialized.
Enter the initialization code you received from Panasonic.

Initialization code

3. Enter the code in the "Initialization code" field.

Password initialization ×

Notify your local dealer of the request code below.

Request code

The password will be initialized.
Enter the initialization code you received from Panasonic.

Initialization code

4. Click [Initialization]. The write lock function will be canceled and no password will be set for the sensor.

Password initialization ×

Notify your local dealer of the request code below.

Request code

The password will be initialized.
Enter the initialization code you received from Panasonic.

Initialization code

7.7 Initializing Settings

You can initialize sensor settings and banks. For details on contents that can be initialized in each operation, refer to the *HL-G2 Series User's Manual (Communication Type)*.

7.7.1 Initialize Sensor

This section explains how to restore sensor settings to the default settings.

1 2 Procedure

1. In the "Device list" window, select a sensor for which settings are to be initialized and click the "Device information" tab.

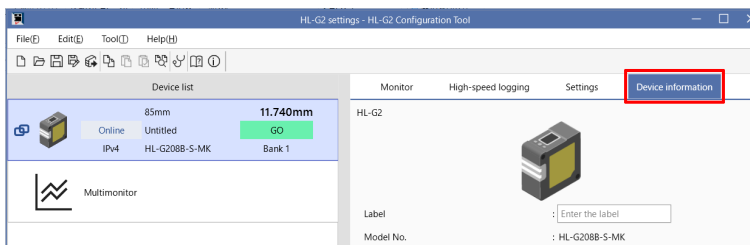

2. Click the [Initialize sensor] button.

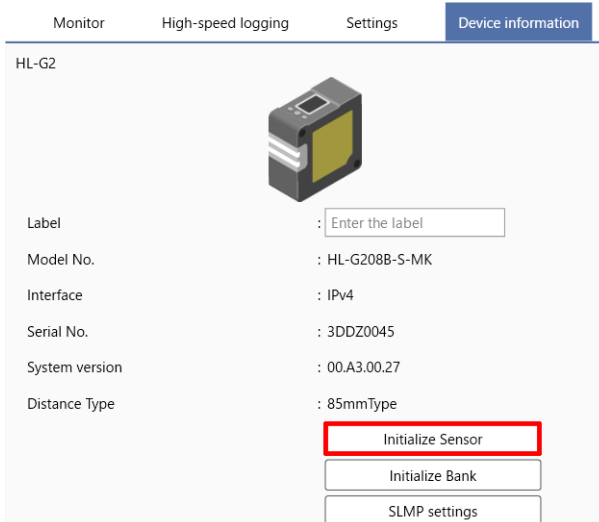

3. A confirmation dialog box will be displayed. Clicking [Yes] displays a confirmation dialog box, asking whether to save the settings.



- Unless you save the settings, the sensor cannot be restored to the state prior to initialization. We recommend that settings be saved before initialization.

4. Click [Yes] to save the settings or [No] to restore the sensor settings to the default settings.

7.7 Initializing Settings

7.7.2 Initialize Bank

This section explains how to initialize banks.

1 2 Procedure

1. In the "Device list" window, select a sensor for which banks are to be initialized and click the "Device information" tab.

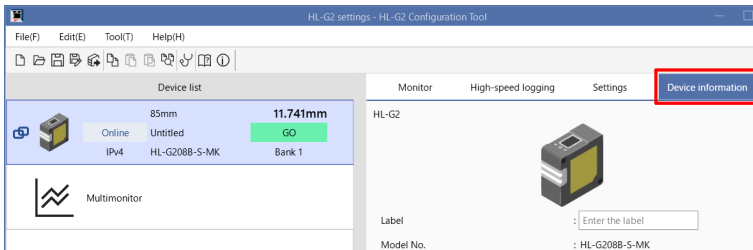

2. Click the [Initialize Bank] button.

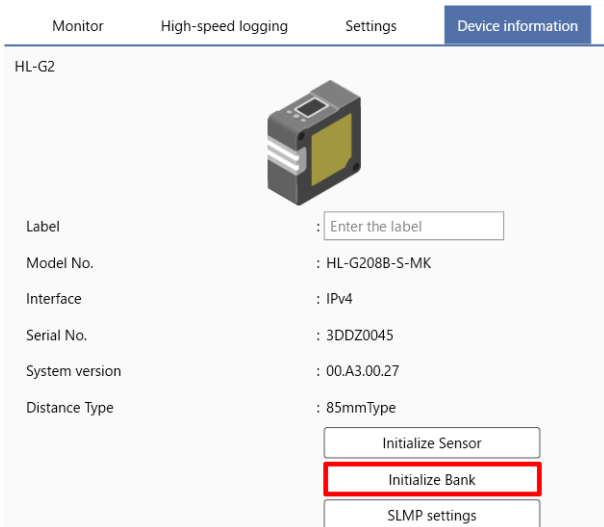

3. Select a target bank to be initialized or "All Banks".

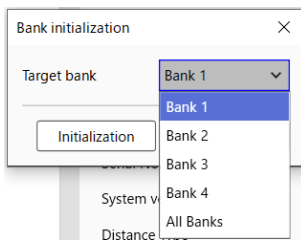

4. Clicking [Initialization] displays a confirmation dialog box. Clicking [Yes] initializes the selected bank.

Bank initialization ×

Target bank ▼

(MEMO)

8 Troubleshooting

8.1 Error Messages and Action Methods.....	8-2
8.2 Alarm Messages and Action Methods	8-3

8.1 Error Messages and Action Methods

8.1 Error Messages and Action Methods

If an error occurs during setup or measurement, icons and the number of occurrences will be displayed in the "Device list" window. Clicking on the product image displays details of the error.

Error code	Description	Action method
E100**	Dark level adjustment error	Install the sensor so that strong light or fluctuating light does not enter the sensor, and turn the power OFF and then ON.
E110**	Communication start processing error	Turn the power OFF and then ON.
E120**	CPU error	Turn the power OFF and then ON.
E130**	Internal memory access error (system area)	Turn the power OFF and then ON.
E131**	Internal memory access error (user area)	Perform the procedure described in "7.7.1 Initialize Sensor".
E140**	Internal access error	Turn the power OFF and then ON.
E150**	Startup processing error	Turn the power OFF and then ON.
E200**	Beam-emitting circuit error	We recommend that the sensor be replaced.

(Note 1) The error code is displayed in 6 digits. Check the contents of error by referring to the first 4 digits of the error code.



- When an error has occurred, check whether the sensor is subject to excessive vibration.
- If the sensor still does not operate normally even after you have taken action as above, consult your local dealer.

8.2 Alarm Messages and Action Methods

If alarm conditions are satisfied during setup or measurement, icons and the number of occurrences will be displayed in the "Device list" window. Clicking on the product image displays details of the alarm.

Alarm message	Action method
Alarm indicating excessive received light intensity	The intensity of received light is too much. Adjust the position and angle of the sensor.
Alarm indicating excessive extraneous light	The intensity of received light is too much. Check if extraneous light hits the light receiving section of the sensor.
Alarm indicating inadequate received light intensity	The received light intensity is insufficient. Adjust the sensor position and remove any stain or shielding objects.



- If the sensor still does not operate normally even after you have taken action as above, consult your local dealer.

(MEMO)

Revision History

Revision history	Revision date	Revision item
1st edition	Jan. 2024	
2nd edition	Apr. 2024	Made revisions in line with the change of the company name.

(MEMO)

(MEMO)

Panasonic Industry Co., Ltd.

1006, Oaza Kadoma Kadoma-shi, Osaka 571-8506, Japan
<https://industry.panasonic.com/>

Please visit our website for inquiries and about our sales network.

© Panasonic Industry Co., Ltd. 2024

April, 2024

WUME-HLG2CT-2