

Motion Controller

GM1 Series

Reference Manual

Pulse Output Unit

[Applicable models]

AGM1PG04T

AGM1PG04L

(MEMO)

Introduction

Thank you for purchasing a Panasonic product. Before you use the product, please carefully read through the installation instructions and the manuals, and understand them in detail to use the product properly.

Types of Manual

- There are different types of manuals for the GM1 series. Refer to the appropriate manual according to your need.
- These manuals can be downloaded from our website: <https://industrial.panasonic.com/ac/e/motor/motion-controller/mc/gm1/index.jsp>.

Manuals for GM1 series

Manual name	Manual code	Description
GM1 Controller RTEX User's Manual (Setup Edition)	WUME-GM1RTXSU	Explains wiring between the GM1 and its peripheral devices, installation method, and operation check method.
GM1 Controller EtherCAT User's Manual (Setup Edition)	WUME-GM1ETCSU	
GM1 Controller RTEX User's Manual (Operation Edition)	WUME-GM1RTXOP	Explains how to use GM Programmer and PANATERM Lite for GM, set up each function, create projects, and perform other operations.
GM1 Controller EtherCAT User's Manual (Operation Edition)	WUME-GM1ETCOP	
GM1 Series Reference Manual (Hardware Edition)	WUME-GM1H	Explains the functions and performance of each GM1 unit.
GM1 Series Reference Manual (Instruction Edition)	WUME-GM1PGR	Explains the specifications of each instruction that can be used with the GM1 Series.
GM1 Series Reference Manual (Analog I/O Unit)	WUME-GM1AIO	Explains the functions and performance of the GM1 Analog Expansion Unit.
GM1 Series Reference Manual (Pulse Output Unit)	WUME-GM1PG	Explains the functions and performance of the GM1 Pulse Output Unit.

Copyright / Trademarks

- The copyright of this manual is owned by **Panasonic Industry Co., Ltd.**
- Unauthorized reproduction of this manual is strictly prohibited.
- Windows is a registered trademark of Microsoft Corporation in the U.S. and other countries.
- EtherCAT is a registered trademark of and patented technology licensed by Beckhoff Automation GmbH, Germany.
- Other company and product names are trademarks or registered trademarks of their respective companies.

Glossary

E-point control

This refers to movement up to an "End Point" and, in this manual, this control is referred to as "E-point control". This method is used for a single-speed acceleration/deceleration.

P-point control

This refers to control which passes through a "Pass Point", and is called "P point control" in this manual. This method is used when a multi-stage target speed is to be specified.

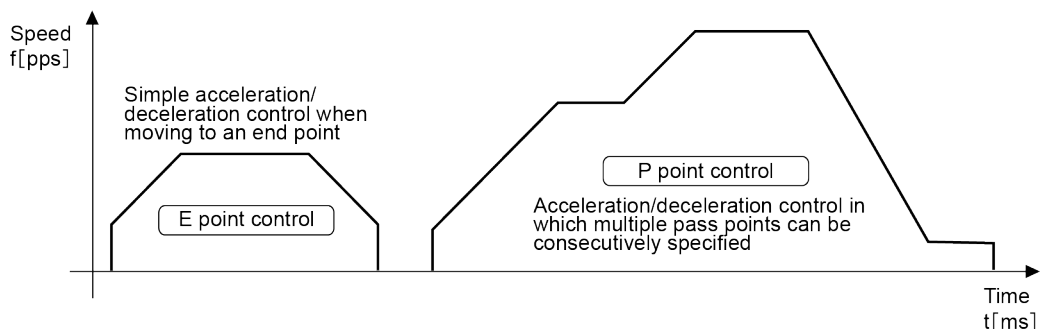

Startup time

This is the time from when the startup signal is output from the CPU to when the pulse output is issued from the pulse output unit. In the Pulse / Sign mode, the signal for specifying a rotation direction is output immediately following the startup, and the pulse output starts after the time specified with the Pulse_4Axes parameters (0.001 ms / 0.005 ms / 0.02 ms).

Acceleration / deceleration

This refers to acceleration from the startup speed to the target speed after the pulse output is issued or deceleration from the target speed to the startup speed.

CW, CCW

Generally, these indicate the direction in which the motor is rotating, with CW referring to clockwise rotation and CCW to counterclockwise rotation. CW is an abbreviation for clockwise and CCW is an abbreviation for counterclockwise.

CW / CCW output method (2-pulse output method)

This is a method in which control is carried out using two pulses, a forward rotation pulse and a reverse rotation pulse.

Pulse / Sign output method (1-pulse output method)

This is a method in which control is carried out using one pulse to specify the speed and ON / OFF signals to specify the direction of rotation.

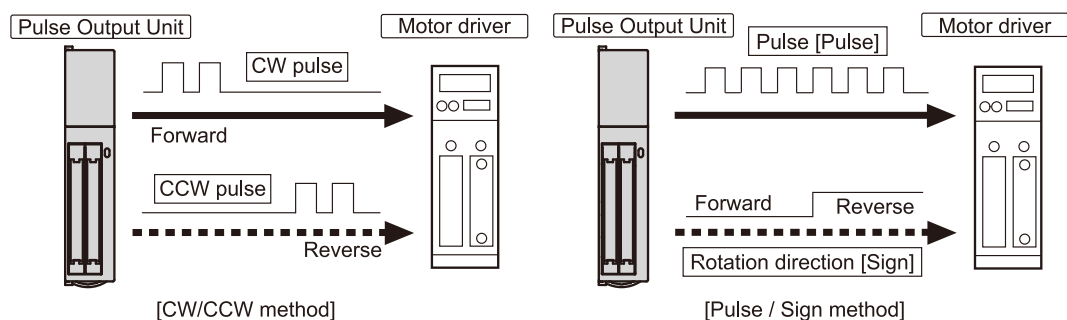

Absolute method (absolute value control method)

This is a control method in which the target position is specified as an absolute position from the home position.

Incremental method (relative value control method)

This is a control method in which the distance from the current position to the target position is specified as a relative position.

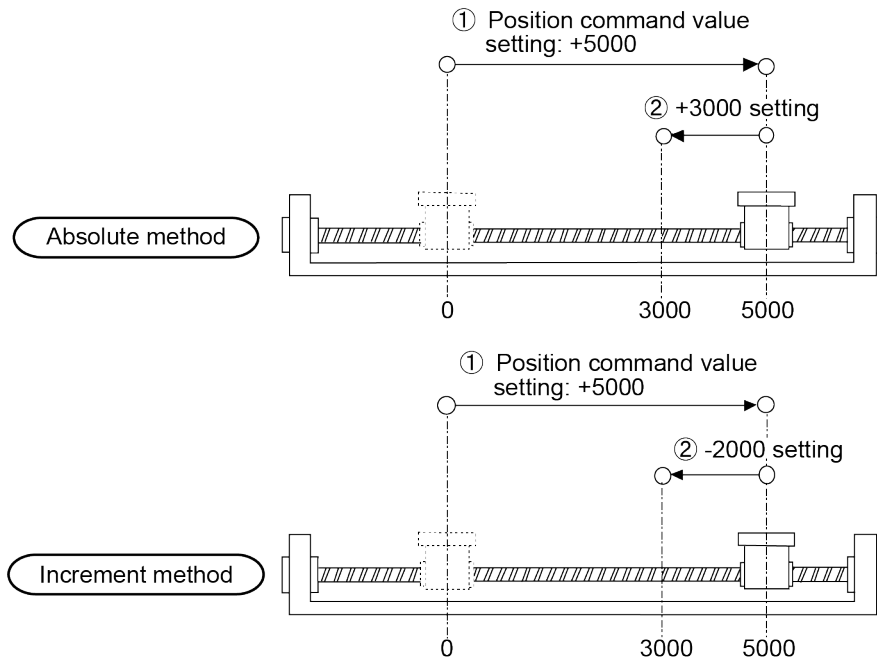

Line driver output

This is one output format used a pulse output signal circuits, in which the push-pull output of the line driver is used. This format offers better resistance to noise than the open collector output format. The line driver must be supported on the motor driver side. Most servo motor amplifiers are equipped with this format.

Open collector output

This is one output format used in pulse output signal circuits, enabling to make connections in accordance with the voltage of the power supply being used by connecting an external resistance. This is used when connecting a driver that does not have line driver input, such as a stepping motor.

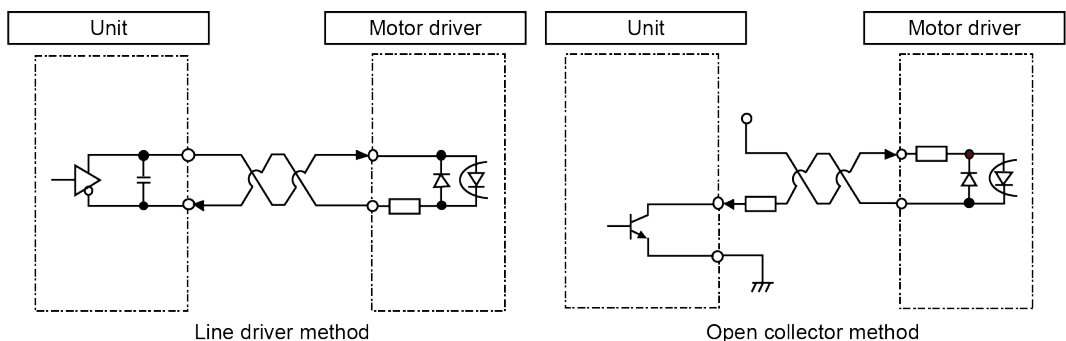

JOG operation

This refers to an operation in which the motor is rotated only while operation commands are being input. This is used to forcibly rotate the motor using input from an external switch, for instance when to make adjustments. This can also be applied to unlimited feed.

Deceleration stop

This is a function that interrupts the operation in progress, slows the rotation and brings it to a stop. This is used to stop an operation halfway.

JOG positioning operation

This refers to an operation to transfer a unlimited feed operation to a positioning operation by an input from the external switch.

Positioning control start input (Timing input)

This is a JOG positioning operation input to transfer a JOG operation to a positioning operation. The pulse count settings can be output after the external switch input.

Over limit input (+), over limit input (-)

This is a limit switch input that is used to limit the motor movement. Over limit input (+) is the limit point on the side where the elapsed value increases and over limit input (-) is the limit point on the side where the elapsed value decreases.

Home return (Home search)

The reference position for positioning is called a Home position and an operation to travel to a Home position is called Home return. Each axis is moved to the preset home position and the coordinates of the home position are defined as absolute position zero. Home search automatically reverses the motor rotation when Over limit input (+) or Over limit input (-) is input and searches the home position or the near home position to return to the home position automatically.

Forced stop

This is a function that interrupts the operation in progress, and stops it immediately. It is used to initiate an emergency stop using an external switch.

Twisted pair cable

This refers to a cable constructed of two wires, which suppresses the effects of noise. As the current of the same size flows in the opposite direction between the two, noise is blanked out, which reduces the effects of the noise.

Home input

This refers to input of the reference position used for positioning, and is connected to the Z phase signal of the servo amplifier, or to an external input switch and sensor.

Near home input

In order to stop the table at the home position, a position at which deceleration begins is called the near home position. This is connected to an external input switch or sensor.

Input valid logic

Depending on the type of sensor and switch connected to the home input and near home input, it is necessary to confirm whether the input signal will be valid when current is flowing, or whether input will be valid when no current is flowing. This is called the "input valid logic".

Deviation counter

This is located inside the servo amplifier, and counts the difference between command pulses and the feedback from the encoder. Command pulses are counted as plus values and feedback pulses are counted as negative values, with control being initiated so that the difference between them is zero.

Deviation counter clear signal

This is output from the pulse output unit, and goes on when a home position return is completed, to notify the driver that the table has arrived at the home position.

Pulser operation

A manual operation is available using a device (pulser) which generates pulses manually. The same type of output as that from the encoder can be obtained.

Transfer multiple

With the pulse output unit, this can be specified when the "pulser input operation " is used. Outputting the number of pulses doubled by the number of pulser input signals, the transfer multiple is said to be "2", and when the number of pulses is five times that of the pulser input signals, the transfer multiple is said to be "5".

Table of Contents

1 Before Using This Product.....	1-1
1.1 Safety Precautions.....	1-2
1.2 Handling Precautions.....	1-3
2 Functions of Unit and Restrictions on Combination.....	2-1
2.1 Unit Functions and How They Work	2-2
2.1.1 Functions of the Unit.....	2-2
2.1.2 Unit Type and Product Number.....	2-3
2.2 Restrictions on Combinations of Units.....	2-4
2.2.1 Unit Combinations for Positioning Control	2-4
2.2.2 Restriction by Power Consumption	2-5
2.2.3 Applicable Versions of Unit and Software	2-5
2.3 Pulse Output Unit.....	2-6
3 Wiring.....	3-1
3.1 Precautions on Wiring.....	3-2
3.2 Connection Using the Discrete-wire Connector	3-3
3.2.1 Specifications of the Discrete-wire Connector	3-3
3.2.2 Wiring the Discrete-wire Connector	3-4
3.3 Input / Output Specifications and Terminal Circuit Diagrams.....	3-7
3.3.1 Terminal Layout Diagram of the GM1 Pulse Output Unit.....	3-7
3.3.2 Input / Output Specifications	3-7
3.4 Supplying Power for Internal Circuit Drive	3-12
3.4.1 Line Driver Output Type	3-12
3.4.2 Transistor Output Type.....	3-12
3.5 Connection of Pulse Command Output Signal	3-13
3.5.1 Line Driver Output Type	3-13
3.5.2 Transistor Output Type.....	3-13
3.6 Connection of Servo ON Output	3-15
3.7 Connection of Deviation Counter Clear Output Signal	3-16
3.8 Connection of Home Input and Near Home Input Signals.....	3-17
3.8.1 Connection of Home Input (When connecting to motor driver Z phase output).....	3-17
3.8.2 Connection of Home Input (When connecting to an external switch/sensor).....	3-17
3.8.3 Connection of Near Home Input Signal	3-17
3.8.4 Connection of Over Limit Input Signal	3-18
3.8.5 Connection of Positioning Control Start Input (Timing Input).....	3-18
3.9 Connections of Pulse Input.....	3-19
3.9.1 Line Driver Type	3-19
3.9.2 Transistor Open Collector Type	3-19
3.9.3 Transistor-resistor Pull-up Type	3-19
4 Project Creation and Parameter Description	4-1

4.1	Adding Expansion Units.....	4-2
4.2	Performing Parameter Settings.....	4-5
4.3	List of Pulse_4Axes Parameters.....	4-6
4.4	Function Blocks Used for the Pulse Output Unit.....	4-8
4.5	Increment and Absolute.....	4-9
4.6	Selection of Acceleration / Deceleration Method.....	4-11
4.7	Servo ON Output.....	4-12
4.7.1	Controlling Servo ON Output.....	4-12
4.7.2	Checking Servo ON Output.....	4-12
4.8	Internal Absolute Counter.....	4-13
4.8.1	Functions of Internal Absolute Counter.....	4-13
4.8.2	How the Internal Absolute Counter Operates.....	4-13
4.8.3	Reading Elapsed Value.....	4-13
4.8.4	Writing Elapsed Value.....	4-14
5	Power ON and OFF, and Items to Check.....	5-1
5.1	Safety Circuit Design.....	5-2
5.2	Items to Check Before Turning ON the Power.....	5-3
5.3	Procedure for Turning On the Power.....	5-4
5.3.1	Procedure for Turning ON the Power.....	5-4
5.3.2	Procedure for Turning OFF the Power.....	5-4
5.4	Confirming while the Power is ON.....	5-6
5.4.1	Items to Check when the Power is ON.....	5-6
5.4.2	Checking the External Safety Circuit.....	5-6
5.4.3	Checking the Safety Circuit based on Pulse Output Unit.....	5-6
5.4.4	Checking the Operation of the Near Home Switch and Home Switch.....	5-7
5.4.5	Checking Rotating and Moving Directions and Moving Distance.....	5-8
6	E Point Control: Single-Speed Acceleration / Deceleration.....	6-1
6.1	Sample Program.....	6-2
6.1.1	Increment (Relative Value Control).....	6-2
6.1.2	Absolute (Absolute Value Control).....	6-4
6.2	Over Limit Input.....	6-7
6.3	Precautions on Programming.....	6-8
7	P Point Control: Multi-Stage Acceleration / Deceleration.....	7-1
7.1	Sample Program.....	7-2
7.1.1	Increment (Relative Value Control).....	7-2
7.1.2	Absolute (Absolute Value Control).....	7-6
7.2	Operation at Over Limit Input.....	7-9
7.3	Precautions On Programming.....	7-10
8	JOG Operation.....	8-1
8.1	Sample Program.....	8-2
8.1.1	JOG Operation (Forward and Reverse).....	8-2

8.1.2 JOG Operation (Speed Changes).....	8-4
8.2 Operation at Over Limit Input.....	8-6
8.3 Precautions on Programming	8-7
9 JOG Positioning Operation.....	9-1
9.1 Sample Program	9-2
9.1.1 Increment (Relative Value Control)	9-2
9.2 Operation at Over Limit Input.....	9-5
9.3 Precautions On Programming.....	9-6
10 Home Return	10-1
10.1 Sample Program	10-2
10.1.1 Home Return.....	10-2
10.2 Types of Home Return	10-5
10.2.1 Home Search Valid Mode	10-5
10.2.2 Home Search Invalid Mode.....	10-7
10.3 Flow of Home Return Operation	10-9
10.3.1 When the Home Input is the Z Phase of Servo Amplifier.....	10-9
10.3.2 When the Home Input is Through an External Switch	10-10
10.4 Home and Near Home Input Logic	10-11
10.4.1 When to Specify NO Contact	10-11
10.4.2 When to specify NC contact.....	10-11
10.5 Practical Use for Home Return	10-13
10.5.1 Using Home Input Only	10-13
10.5.2 Using One Switch for Near Home Input and Home Input	10-14
10.6 Over Limit Input.....	10-17
10.7 Precautions on Programming	10-19
11 Pulser Input Operation	11-1
11.1 Sample Program	11-2
11.1.1 Pulser Input Operation	11-2
11.2 Operation at Over Limit Input.....	11-5
11.3 Precautions on Programming.....	11-6
11.4 Types of Manual Pulse Generators that Can be Used.....	11-7
12 Deceleration Stop and Forced Stop	12-1
12.1 Sample Program	12-2
12.1.1 Deceleration Stop	12-2
12.1.2 Forced Stop	12-4
12.1.3 Resuming Operation After Stop	12-5
12.2 Precautions on Stop Operations	12-8
13 Feedback Counter.....	13-1
13.1 Sample Program	13-2
13.1.1 Step Out Detection by Comparing Feedback Value with Elapsed Value	13-2

13.2 Feedback Counter Function.....	13-4
13.2.1 Feedback Counter Function.....	13-4
13.2.2 Operation of Feedback Counter.....	13-4
13.2.3 Feedback Counter Settings	13-4
13.2.4 Input Method of Feedback Counter	13-5
14 Precautions Concerning Unit Operation and Programs	14-1
14.1 Precautions Relating to Basic Operations of the Unit.....	14-2
14.1.1 Operation When the Controller Switches from RUN to STOP Mode	14-2
14.1.2 Restrictions after Starting Operation.....	14-2
15 Troubleshooting.....	15-1
15.1 Pulse Output Unit Operation If an Error Occurs.....	15-2
15.1.1 If the Pulse Output Unit ERROR LED Lights	15-2
15.1.2 If the Controller ERROR LED Lights.....	15-2
15.2 Errors Which Occur in Pulse Output Unit.....	15-3
15.3 What to Do If an Error Occurs.....	15-4
15.3.1 If the Pulse Output Unit ERROR LED Lights	15-4
15.3.2 What to Do When a Limit Error Occurs.....	15-4
15.3.3 If the Motor Does Not Turn (if the LED for pulse output A or B is flashing or lit).....	15-4
15.3.4 If the Motor Does Not Turn (if the LED for pulse output A or B is not lit)	15-5
15.3.5 Rotation/Movement Direction is Reversed.....	15-5
15.3.6 The Stopping Position is OFF for a Home Return	15-6
15.3.7 Speed Does Not Slow Down for a Home Return	15-7
15.3.8 Movement Does Not Stop at Home Position (after decelerating for home return)	15-8
16 Specifications.....	16-1
16.1 General Specifications	16-2
16.2 Performance Specifications of the Pulse Output Unit.....	16-3
16.2.1 Input / Output Specifications	16-4
16.3 Dimensions	16-8
16.3.1 Pulse Output Unit.....	16-8
Appendix Warranty / Cautions for Proper Use.....	App-1
Warranty	App-2
Warranty Period	App-2
Warranty Scope	App-2
Cautions for Proper Use	App-3

1 Before Using This Product



1.1 Safety Precautions.....	1-2
1.2 Handling Precautions.....	1-3



1.1 Safety Precautions





1.1 Safety Precautions









This section explains important rules that must be observed to prevent personal injury and property damage.

- Injuries and damages that may occur as a result of incorrect use are classified into the following levels and safety precautions are explained according to the level.

 WARNING	Indicates that there is a risk of death or serious injury
 CAUTION	Indicates that there is a risk of minor injury or property damage





	Indicates an action that is prohibited
	Indicates an action that must be taken

 WARNING	
	<ul style="list-style-type: none"> • Take safety measures outside this product to ensure the safety of the entire system even if this product fails or an error occurs due to external factors.
	<ul style="list-style-type: none"> • Do not use this product in atmospheres that contain flammable gases. Doing so may result in explosion.
	<ul style="list-style-type: none"> • Do not throw this product into the fire. Doing so may cause the batteries or other electronic parts to explode.

 CAUTION	
	<ul style="list-style-type: none"> • To prevent abnormal heat generation or smoke generation, use this product with some leeway from the guaranteed characteristics and performance values of the product.
	<ul style="list-style-type: none"> • Do not disassemble or modify this product. Doing so may result in abnormal heat generation or smoke generation.
	<ul style="list-style-type: none"> • Do not touch any terminals while the power is on. Doing so may result in electrical shock.
	<ul style="list-style-type: none"> • Configure emergency stop and interlock circuits outside this product.
	<ul style="list-style-type: none"> • Connect wires and connectors properly. Failure to do so may result in abnormal heat generation or smoke generation.
	<ul style="list-style-type: none"> • Do not perform work (such as connection or removal) with the power turned on. Doing so may result in electrical shock.
	<ul style="list-style-type: none"> • If this product is used in any way that is not specified by Panasonic, its protection function may be impaired.
	<ul style="list-style-type: none"> • This product has been developed and manufactured for industrial use only.

1.2 Handling Precautions

- In this manual, the following symbols are used to indicate safety information that must be observed.

	Indicates an action that is prohibited or a matter that requires caution.
	Indicates an action that must be taken.
	Indicates supplemental information.
	Indicates details about the subject in question or information useful to remember.
	Indicates operation procedures.

(MEMO)

2 Functions of Unit and Restrictions on Combination

2.1 Unit Functions and How They Work	2-2
2.1.1 Functions of the Unit	2-2
2.1.2 Unit Type and Product Number	2-3
2.2 Restrictions on Combinations of Units	2-4
2.2.1 Unit Combinations for Positioning Control	2-4
2.2.2 Restriction by Power Consumption	2-5
2.2.3 Applicable Versions of Unit and Software	2-5
2.3 Pulse Output Unit.....	2-6

2.1 Unit Functions and How They Work

2.1 Unit Functions and How They Work

2.1.1 Functions of the Unit

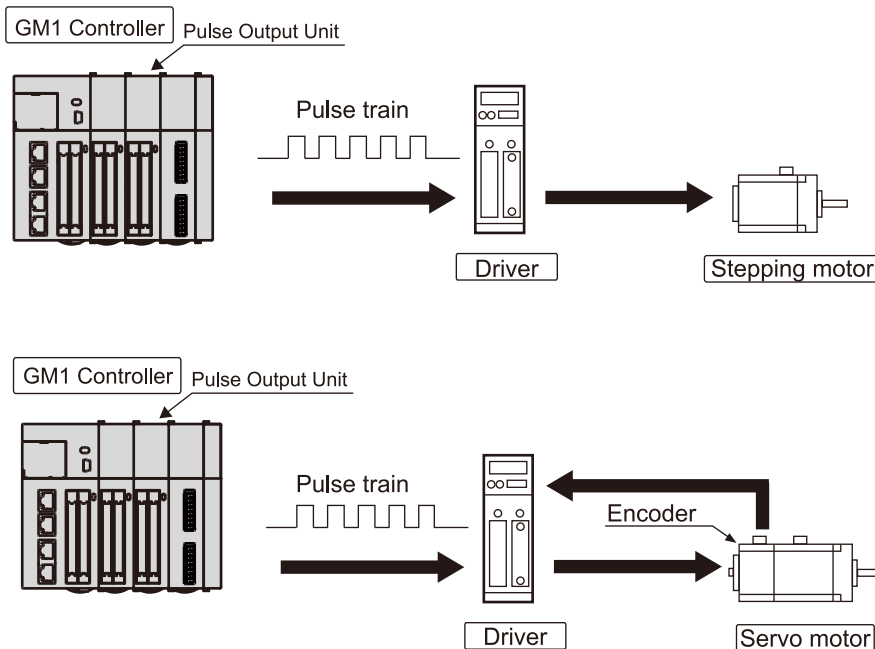

■ Position control is available using Stepping motor or Servo motor.

- Positioning can be controlled through the combination of a servo motor and a stepping motor with a driver using the pulse train input method.
- The unit is available in two types; one is the line driver output type that can handle the high-speed control, and the other is the transistor output type that can support the driver for the open collector type such as a stepping motor.

■ Independent control is possible for 4 axes.

- The control is internally carried out independently for each axis so that highly accurate positioning is possible even with multiple axes.
- As the simultaneous startup can be performed for multiple axes, the linear interpolation control using user programs is also possible.

■ Quick start is possible.

- The time until the pulse output starts can be selected from 0.001 ms, 0.005 ms or 0.02 ms. It supports high-speed repeat operation.

■ Various position controls are achievable using simple program.

- Automatic acceleration / deceleration control is performable only by providing a startup speed, target speed, acceleration / deceleration and command position as data.

- Trapezoidal control by single-speed acceleration/deceleration (E point control), trapezoidal control by multi-stage acceleration/deceleration (P point control), position control from external input timing (JOG positioning control) and pulser input operation can be performed.
- **Feedback counter function**
 - The feedback counter function is provided which enables to count input signals from devices such as an external encoder at high speed. This function is applied for step out detection by comparing feedback values with elapsed values.
- **Input logic can be changed.**
 - Input logic can be changed for home input, near home input or over limit input, which allows flexible system configuration.

2.1.2 Unit Type and Product Number

■ Unit type and product number

Number of axes	Output type	Product No.
4-axis type	Transistor output type	AGM1PG04T
	Line driver output type	AGM1PG04L

2.2 Restrictions on Combinations of Units

2.2.1 Unit Combinations for Positioning Control

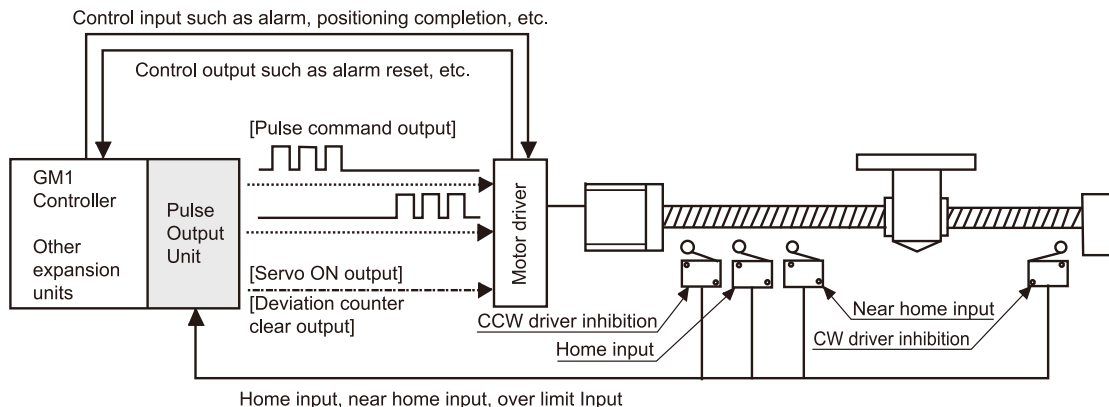

■ Interfaces provided with the pulse output unit

- In addition to pulse command output for the motor driver, the pulse output unit is equipped with the following inputs and outputs.

Home input

Near home input

Over limit input (+)

Over limit input (-)

Positioning control start input (timing input) for JOG positioning operation

Servo ON output for the servo amplifier

Deviation counter clear output

- For PLC safety circuit and control signal interfaces, use I/O connectors of the GM1 Controller and other expansion units in combination.

■ Counting the number of output pulses

The number of pulses output is counted as an absolute value by an internal counter inside the pulse output unit, which counts them as the "elapsed value".

Counting range: -2,147,483,648 to +2,147,483,647 (signed 32-bit)

■ Counting the number of input pulses from the external encoder

The number of pulses input is counted as an absolute value by an internal counter inside the pulse output unit, which counts them as the "feedback count value".

Counting range: -2,147,483,648 to +2,147,483,647 (signed 32-bit)

i Info.

- If the "elapsed value" or "feedback count value" exceeds the maximum / minimum value, the value returns automatically to the minimum / maximum value and counting continues from that point.
- The motor does not stop if this occurs, and no error occurs.

2.2.2 Restriction by Power Consumption

The unit has the following internal current consumption. Make sure that the total current consumption is within the capacity of the power supply with consideration of all other units used in combination with this unit.

Name	Specifications	Product No.	Consumption current
GM1 Pulse Output Unit	4-axis	Transistor output	120 mA or less
		Line driver output	

2.2.3 Applicable Versions of Unit and Software

For using the GM1 Pulse Output Unit, the GM1 Controller and GM Programmer with the following versions are required.

Name	Applicable version
RTEX-compatible GM1 Controller (Sink type)	AGM1CSRX16T Ver.1.2.0.0 or later
EtherCAT-compatible GM1 Controller (Sink type)	AGM1CSEC16T Ver.1.2.0.0 or later
EtherCAT-compatible GM1 Controller (Source type)	AGM1CSEC16P
GM Programmer	Ver.1.2.0.0 or later

2.3 Pulse Output Unit

2.3 Pulse Output Unit

Names and Functions of Components

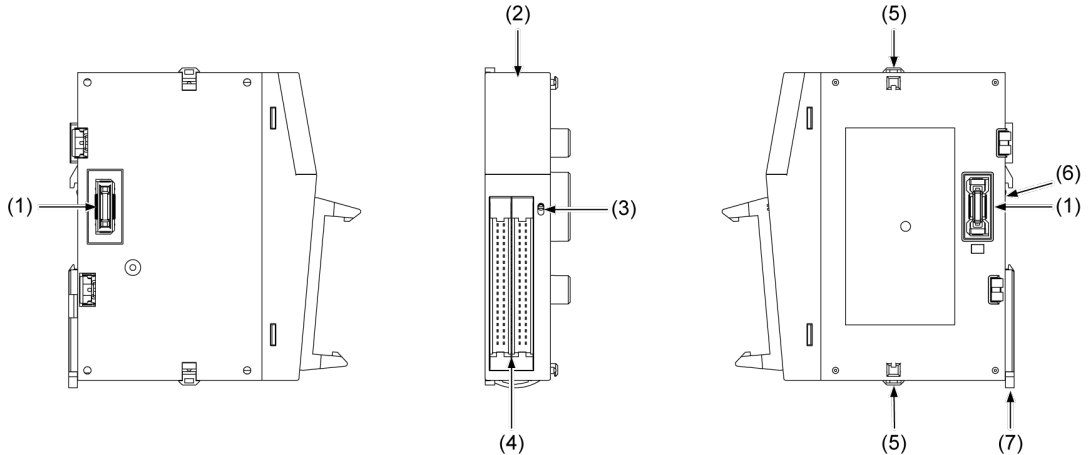

No.	Name	Function
(1)	Unit connector	This is a connector to which each expansion unit is connected.
(2)	Operation monitor LEDs	These LEDs indicate the status of expansion units.
(3)	Operation monitor selection switch	This switches operation display between the display for axes 1 and 2, and that for axes 3 and 4.
(4)	Output connector	This is used to connect an output device.
(5)	Expansion hook	This is a hook used to fix each expansion unit to another.
(6)	DIN rail attachment part	This is the part which is attached to the DIN rail.
(7)	DIN hook	Used to fix the Controller to a DIN rail

Names and functions of each operation monitor LED

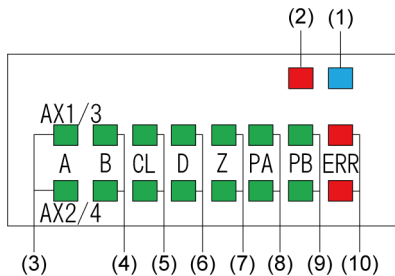

No.	Name	LED color	Function
(1)	Power	Blue	Indicates the completion of power processing of the unit. Lit: Power supply of the unit is started normally. Unlit: Power is not supplied. Or, there is an error in the power supply to the system.
(2)	Alarm	Red	Indicates that an alarm has occurred in the unit. Lit: Unit error

No.	Name	LED color	Function
			Unlit: Normal
(3)	A	Green	Indicates the pulse output A signal. ^(Note 1) <ul style="list-style-type: none"> When set to pulse / sign output method Flashing: During pulse output Unlit: During stop When set to CW / CCW output method Flashing: During pulse output (Forward) Unlit: During stop (Forward)
(4)	B	Green	Indicates the pulse output B signal. ^(Note 1) <ul style="list-style-type: none"> When set to pulse / sign output method Lit: Reverse direction command Unlit: Forward direction command When set to CW / CCW output method Flashing: During pulse output (Reverse) Unlit: During stop (Reverse)
(5)	CL	Green	Indicates the counter clear signal output. Lit: Output ON Unlit: Output OFF
(6)	D	Green	Indicates the near home status. ^(Note 2) Lit: ON Unlit: OFF
(7)	Z	Green	Indicates the home input state. ^(Note 2) Lit: ON Unlit: OFF
(8)	PA	Green	Indicates the pulse input A signal. ^(Note 3)
(9)	PB	Green	Indicates the pulse input B signal. ^(Note 3)
(10)	ERR	Red	Indicates that an error has occurred in the unit. Lit: Error occurred. Unlit: Normal

(Note 1) The pulse output signal display LEDs (A and B) blink at the output frequency (speed). For this reason they may appear to light steadily at high-speed output.

(Note 2) The near home (D) and home input (Z) LEDs light when the respective input becomes valid.

(Note 3) Pulse input signal (PA) and (PB) display the pulse signal input status.

(MEMO)

3 Wiring

3.1	Precautions on Wiring	3-2
3.2	Connection Using the Discrete-wire Connector	3-3
3.2.1	Specifications of the Discrete-wire Connector	3-3
3.2.2	Wiring the Discrete-wire Connector	3-4
3.3	Input / Output Specifications and Terminal Circuit Diagrams	3-7
3.3.1	Terminal Layout Diagram of the GM1 Pulse Output Unit	3-7
3.3.2	Input / Output Specifications	3-7
3.4	Supplying Power for Internal Circuit Drive	3-12
3.4.1	Line Driver Output Type	3-12
3.4.2	Transistor Output Type	3-12
3.5	Connection of Pulse Command Output Signal	3-13
3.5.1	Line Driver Output Type	3-13
3.5.2	Transistor Output Type	3-13
3.6	Connection of Servo ON Output	3-15
3.7	Connection of Deviation Counter Clear Output Signal	3-16
3.8	Connection of Home Input and Near Home Input Signals	3-17
3.8.1	Connection of Home Input (When connecting to motor driver Z phase output)	3-17
3.8.2	Connection of Home Input (When connecting to an external switch/sensor)	3-17
3.8.3	Connection of Near Home Input Signal	3-17
3.8.4	Connection of Over Limit Input Signal	3-18
3.8.5	Connection of Positioning Control Start Input (Timing Input)	3-18
3.9	Connections of Pulse Input	3-19
3.9.1	Line Driver Type	3-19
3.9.2	Transistor Open Collector Type	3-19
3.9.3	Transistor-resistor Pull-up Type	3-19

3.1 Precautions on Wiring

3.1 Precautions on Wiring

Connect the wire in less than the following length between the pulse output unit and the motor driver, and the pulse inputs, using twisted-pair cables.

■ Signals applicable

- Transistor output
- Line driver output
- Servo ON output
- Deviation counter clear output
- Home input (Motor driver Z phase)
- Pulse input (Pulser input, feedback counter)

Output type	Product No.	Wiring length
Transistor output type	AGM1PG04T	10 m
Line driver output type	AGM1PG04L	

3.2 Connection Using the Discrete-wire Connector

No discrete-wire connector is provided with the unit. Purchase it separately.

3.2.1 Specifications of the Discrete-wire Connector

This is a connector that allows loose wires to be connected without removing the wire's insulation. Use a special tool for wire connection.

Discrete-wire connector (40P)

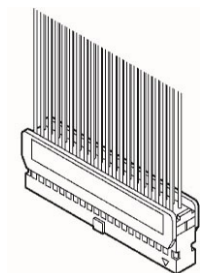

■ AFP2801 Discrete-wire Connector (Purchase separately)

Composition of parts	Quantity (2 sets)
Housing (40P)	1 pc.
Semi-cover (40P)	2 pc.
Contact (For AWG22 and AWG24 5 pins)	8 pc.

■ Compatible wires (stranded wire)

Size	Nominal cross-sectional area	Insulation thickness	Rated current
AWG22	0.3 mm ²	Φ1.5 to Φ1.1	3 A
AWG24	0.2 mm ²		

■ AXY52000FP Dedicated crimping tool (Purchase separately)

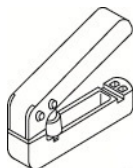

3.2 Connection Using the Discrete-wire Connector

3.2.2 Wiring the Discrete-wire Connector



- When performing wiring work, refer to the instruction manual of the crimping tool in order to prevent faulty wiring.

1₂

Procedure

1. Bend and break the contact, and set it in the crimping tool.

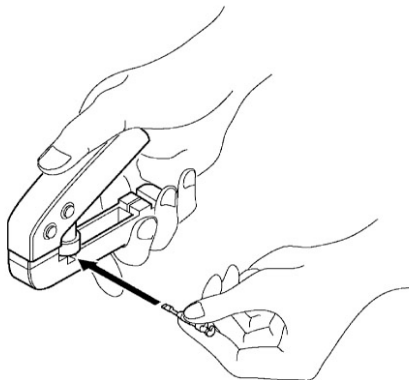

2. Insert the wire without removing its insulation until it stops, and lightly grip the crimping tool.

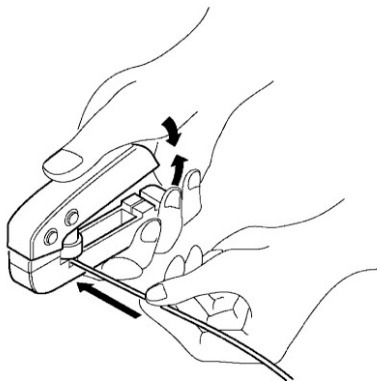

3. The contact appears as shown below after it is crimped. Confirm the following two points.
 1. The wire must be embraced inside the clamped part.
 2. The wire must be inserted to the end.

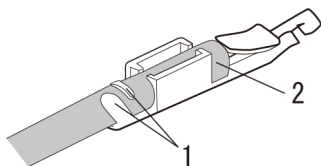

4. Insert the wire with the contact into the housing.

3.2 Connection Using the Discrete-wire Connector

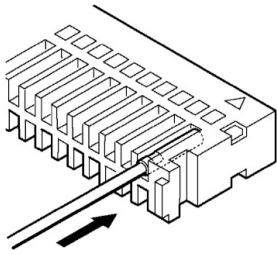

5. When all the wires have been inserted, fit the semi-cover into place.

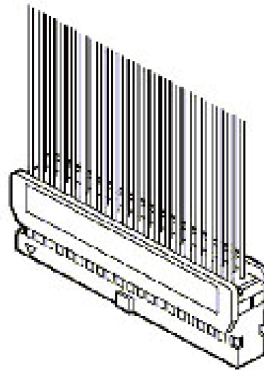
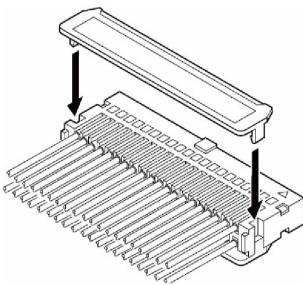

3.2 Connection Using the Discrete-wire Connector

i Info.

- If there is a wiring mistake or the wire is incorrectly press-fit, use the crimping tool to remove the contact.
 1. Set the pin of the crimping tool at the position indicated by an arrow.

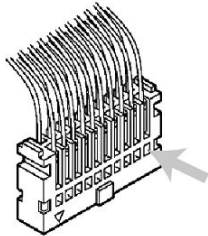

2. Hold the housing with fingers and pull the wire.

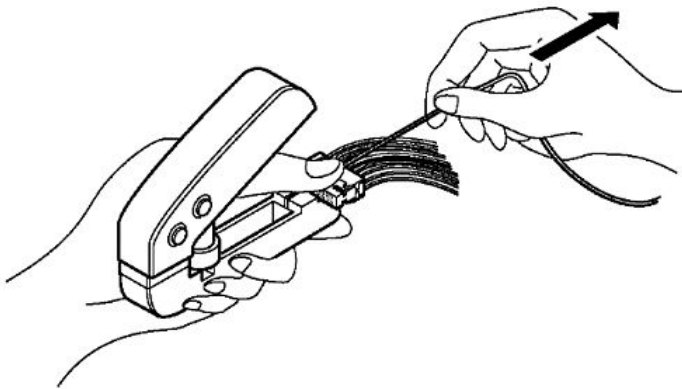

3.3 Input / Output Specifications and Terminal Circuit Diagrams

3.3.1 Terminal Layout Diagram of the GM1 Pulse Output Unit

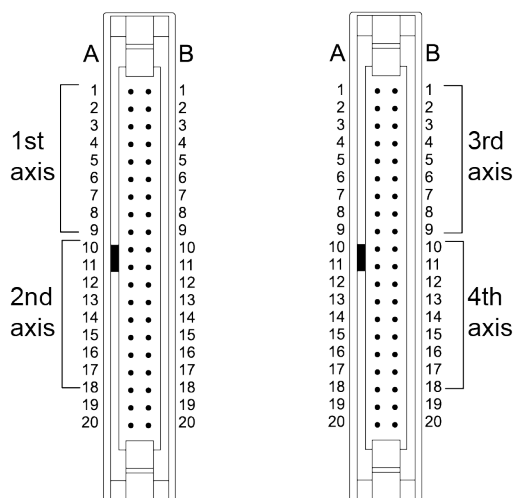

3.3.2 Input / Output Specifications

- The signal pins for two axes are assigned to one connector.
- The connector for 1- and 2-axis has completely the same pin arrangements as the connector for 3- and 4-axis. Therefore, the same pin number functions the same.
- The specifications of the pulse output terminal of the transistor type are different from those of the line driver type. However, the specifications of the input terminal and the power supply terminal are the same for both types.

Output terminals (Transistor output type)

Pin No.		Circuit	Signal name	Output specifications		
Axis 1 / 3	Axis 2 / 4			Item	Description	
A1	A10		A1/A10 A2/A11	Pulse output A: 5 VDC output	Output type	Open collector
B1	B10		B1/B10 B2/B11	Pulse output A: Open collector	Operating voltage range	4.75 to 26.4 V DC
A2	A11		Pulse output B: 5 VDC output	Max. load current	15 mA	
B2	B11		Pulse output B: Open collector	ON state max. voltage drop	0.6 V	

3.3 Input / Output Specifications and Terminal Circuit Diagrams

Output terminals (Line driver output type)

Pin No.		Circuit	Signal name	Output specifications	
Axis 1 / 3	Axis 2 / 4			Item	Description
A1	A10		Pulse output A: Line driver (+)	Output type	Line driver output Equivalent to AM26C31
B1	B10		Pulse output A: Line driver (-)		
A2	A11		Pulse output B: Line driver (+)		
B2	B11		Pulse output B: Line driver (-)		

Output terminals (common)

Pin No.		Circuit	Signal name	Output specifications	
Axis 1 / 3	Axis 2 / 4			Item	Description
B5	B14		Servo ON output (+)	Output type	Open collector
				Operating voltage range	4.75 to 26.4 V DC
A7	A16		Deviation counter clear (+)	Max. load current	10 mA
B7	B16		COM	ON state max. voltage drop	1.0 V

(Note 1) The deviation counter clear signal is output when the power supply is turned ON for about 1 ms. When the home return is complete, the signal is output for about 1 ms or 10 ms. The time can be specified using the "Parameter".

Power supply terminal (common)

Pin No.	Circuit	Signal name	Power supply specifications	
			Item	Description
A20		External power supply input: 24 V DC (+)	Supplied power supply range	21.4 to 26.4 V DC
B20		External power supply input: 24 V DC (-)	Consumption current	90 mA or less

(Note 1) The external power supply input terminals between two connectors are connected internally.

3.3 Input / Output Specifications and Terminal Circuit Diagrams

Input terminals (common)

Pin No.		Circuit	Signal name	Input specifications	
Axis 1 / 3	Axis 2 / 4			Item	Description
A3	A12		Home input 24 V DC (+) (Z24)	Operating voltage range	21.6 to 26.4 V DC
				Min. ON voltage / current	19.2 V DC / 5.5 mA
				Max. OFF voltage/ current	2 V DC / 2 mA
				Input impedance	Approx. 3.9 kΩ
				Pulse width	100 μs or more
A4	A13		Home input 5 V DC (+) (Z5)	Operating voltage range	3.5 to 5.25 V DC (5 V DC, Line driver specifications)
				Min. ON voltage / current	3 V DC / 4 mA
				Max. OFF voltage/ current	1 V DC / 0.5 mA
				Input impedance	Approx. 560 Ω
				Pulse width	100 μs or more
B3	B12		Home input (-)	-	-
B4	B13		COM	-	-
A5	A14		Near home input (DOG)	Operating voltage range	21.6 to 26.4 V DC
				Min. ON voltage / current	Near home input (DOG) 19.2 V DC / 5.0 mA Over limit input (+) Over limit input (-) Positioning control start input (Timing input) 19.2 V DC / 2.6 mA
A6	A15		Over limit input (+)	Max. OFF voltage/ current	2 V DC / 1.5 mA
B6	B15		Over limit input (-)	Input impedance	Near home input (DOG) Approx. 3.6 kΩ Over limit input (+) Over limit input (-) Positioning control start input (Timing input) Approx. 6.8 kΩ
					A19

3.3 Input / Output Specifications and Terminal Circuit Diagrams

Pin No.		Circuit	Signal name	Input specifications	
Axis 1 / 3	Axis 2 / 4			Item	Description
A8	A17		Pulse input A (+)	Operating voltage range	3.5 to 5.25 V DC (5 V DC, Line driver specifications)
B8	B17		Pulse input A (-)	Min. ON voltage / current	3 V DC / 3.2 mA
A9	A18		Pulse input B (+)	Max. OFF voltage/ current	1 V DC / 0.5 mA
B9	B18		Pulse input B (-)	Input impedance	Approx. 560 Ω
				Pulse width	0.5 μs or more (Max. 1 MHz each phase)

- The pulse input A and B signals should be used within the following specifications.

When using the pulse input A and B signals for 2-phase input method

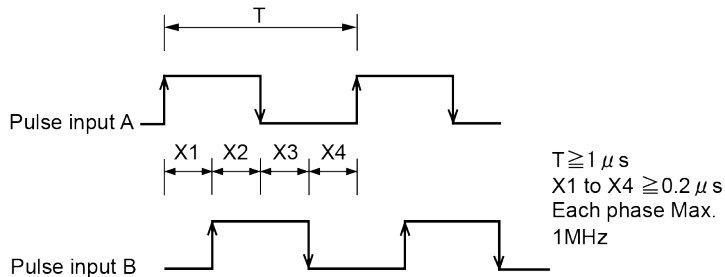

When using the pulse input A and B signals for direction discrimination input method

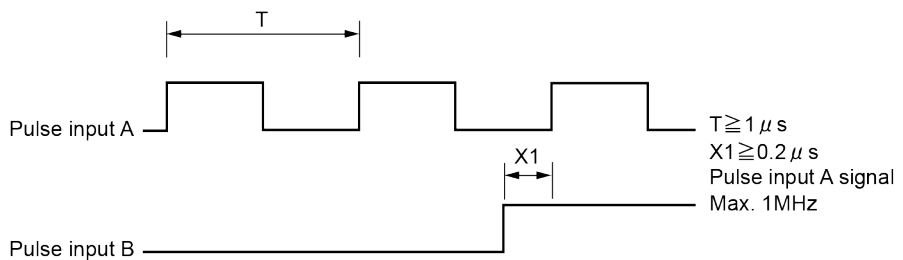

When using the pulse input A and B signals for individual input method

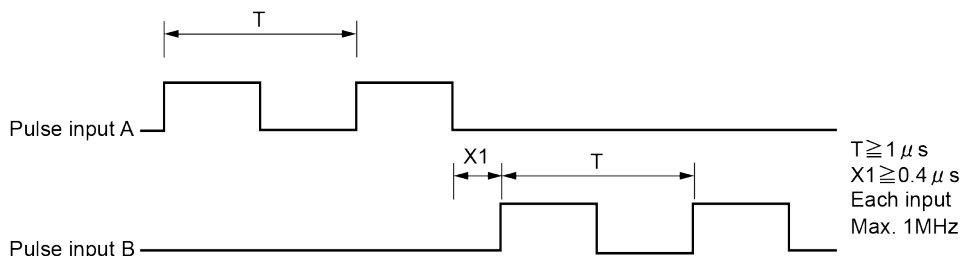

- When the pulse inputs A and B are used as pulser input, it is 2-phase input.

3.4 Supplying Power for Internal Circuit Drive

3.4 Supplying Power for Internal Circuit Drive

3.4.1 Line Driver Output Type

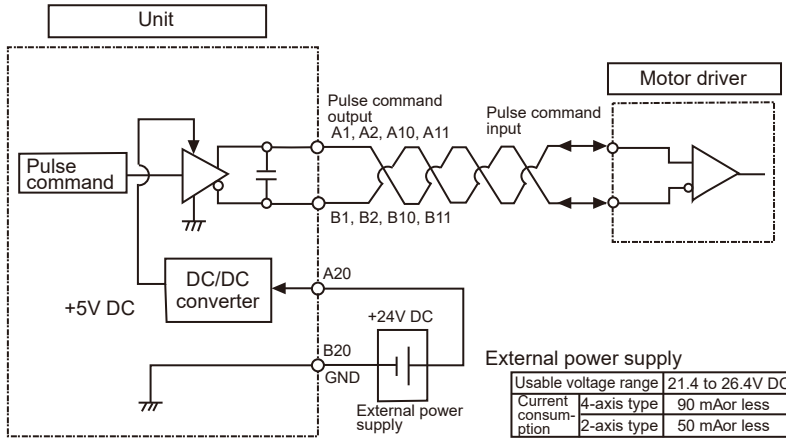

The illustration shows one signal component extracted from the overall configuration.

3.4.2 Transistor Output Type

The power supply for the pulser command output circuit can be taken from the 5 V DC output pins.d

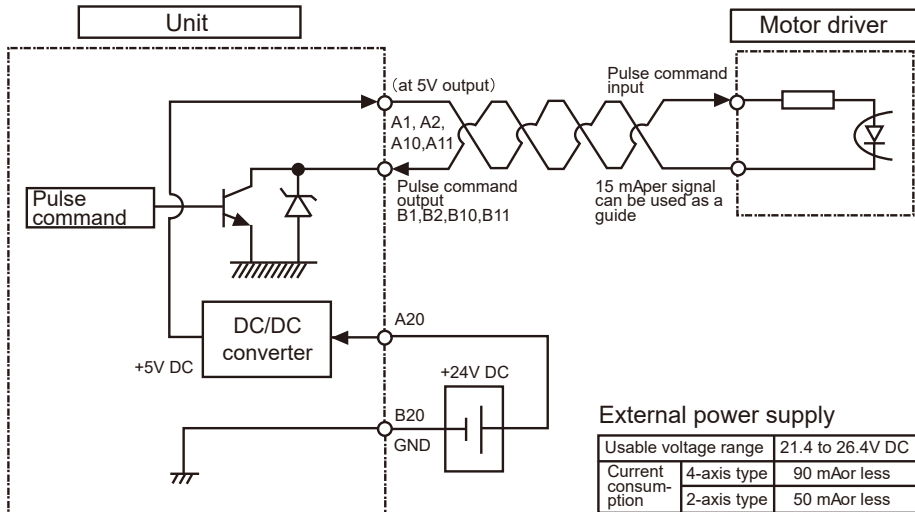

- When transistor output (open collector output) is used, a value of 15 mA per signal should be used as a guide. If 15 mA is exceeded, an appropriate resistance should be added.

3.5 Connection of Pulse Command Output Signal

The pulse output unit is equipped with two output types to match two types of motor driver interfaces. Connect to either one of them depending on the interface of the motor driver to be used.

3.5.1 Line Driver Output Type

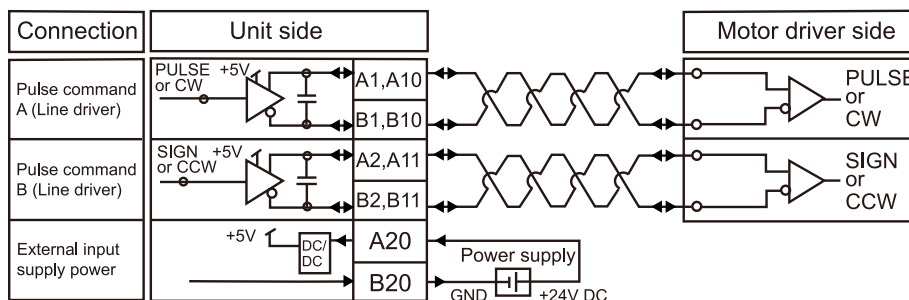

3.5.2 Transistor Output Type

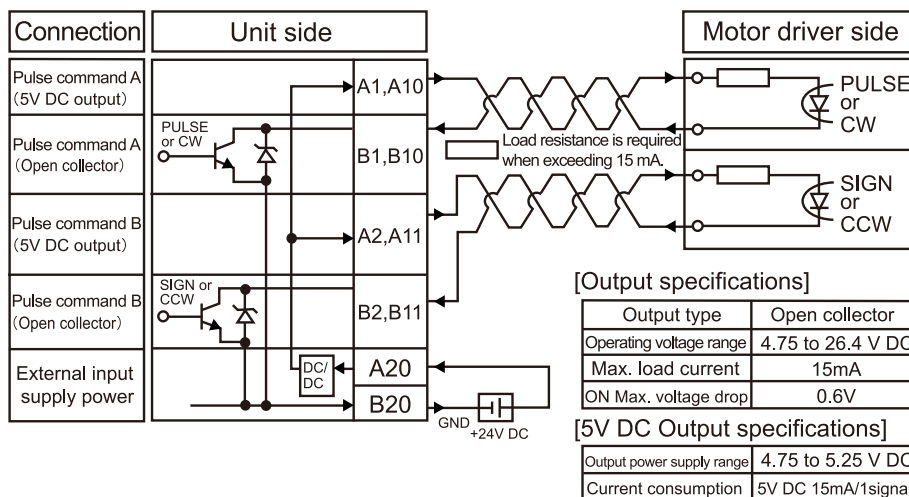

3.5 Connection of Pulse Command Output Signal

i Info.

- A value of 15 mA per signal should be used as a guide. If this is exceeded, resistance should be added.
- The symbol below indicates a twisted-pair wiring. We recommend using twisted-pair cables as the wiring between the output of the pulse output unit and the motor driver.

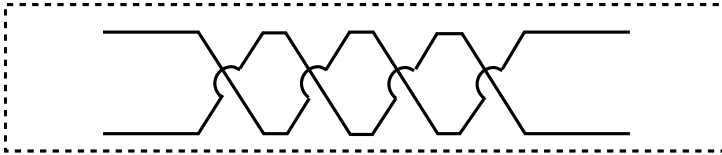

3.6 Connection of Servo ON Output

- This is an example showing the connection of the servo ON to the servo amplifier.
- An external power supply (+5 V DC to +24 V DC) must be provided for the connection.

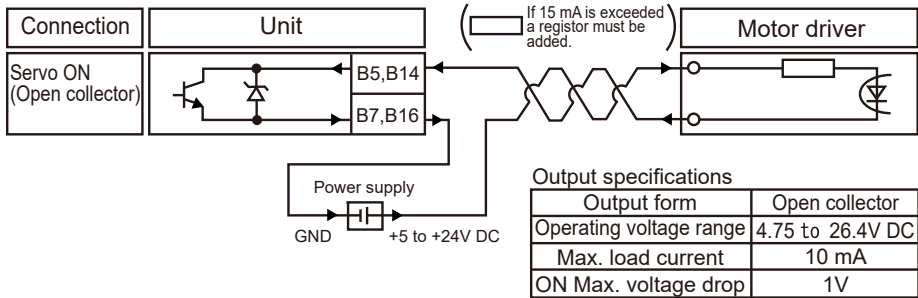

3.7 Connection of Deviation Counter Clear Output Signal

3.7 Connection of Deviation Counter Clear Output Signal

- This is an example showing the connection of the counter clear input to the servo amplifier.
- An external power supply (+5 V DC to +24 V DC) must be provided for the connection.

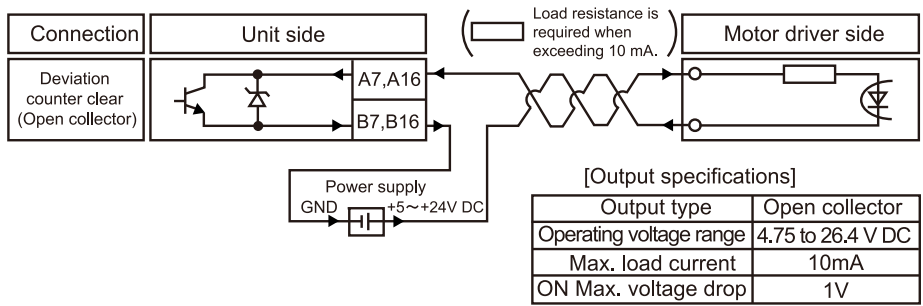

Note

- Always use twisted-pair cables for wiring.
- The current which can be conducted as the deviation counter clear output signal is 10 mA max. If this is exceeded, a resistance should be added.

3.8 Connection of Home Input and Near Home Input Signals

3.8 Connection of Home Input and Near Home Input Signals

3.8.1 Connection of Home Input (When connecting to motor driver Z phase output)

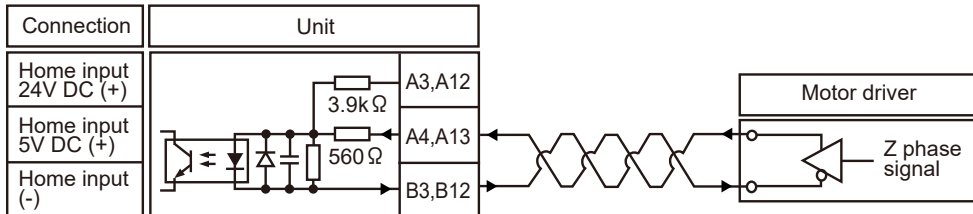

Input specifications (at 5V DC)

Input voltage range	3.5 to 5.25V DC
Min. ON voltage/current	3V DC/4mA
Max. OFF voltage/current	1V DC/0.5mA
Input impedance	560Ω
Min. input pulse width	100 μs

3.8.2 Connection of Home Input (When connecting to an external switch/sensor)

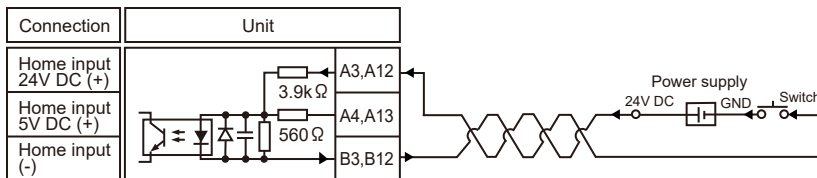

Input specifications (at 24V DC)

Input voltage range	21.6 to 26.4V DC
Min. ON voltage/current	19.2V DC/5.5mA
Max. OFF voltage/current	2V DC/2mA
Input impedance	3.9kΩ
Min. input pulse width	100 μs

3.8.3 Connection of Near Home Input Signal

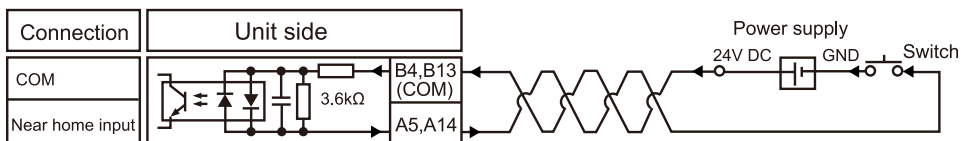

[Input specifications]

Input voltage range	21.6 to 26.4 V DC
Min. ON voltage/current	19.2V DC/5.0mA
Max. OFF voltage/current	2V DC/1.5mA
Input impedance	Approx. 3.6kΩ
Min. input pulse width	500μs

3.8 Connection of Home Input and Near Home Input Signals

(Note 1) Terminal numbers B4 and B13 are common for the Near home input, Over limit input (+), Over limit input (-) and Positioning control start input.

3.8.4 Connection of Over Limit Input Signal

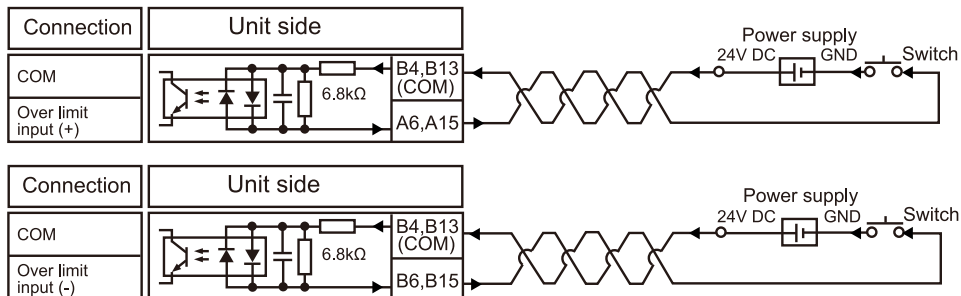

[Input specifications]

Input voltage range	21.6 to 26.4 V DC
Min. ON voltage/current	19.2V DC/2.6mA
Max. OFF voltage/current	2V DC/1.5mA
Input impedance	Approx. 6.8kΩ
Min. input pulse width	500μs

(Note 1) Terminal numbers B4 and B13 are common for the Near home input, Over limit input (+), Over limit input (-) and Positioning control start input.

3.8.5 Connection of Positioning Control Start Input (Timing Input)

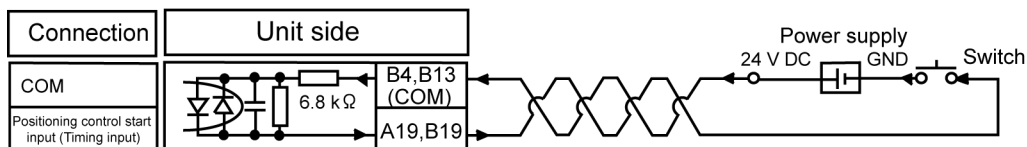

[Input specifications]

Input voltage range	21.6~26.4 V DC
Min. ON voltage/current	19.2 V DC/2.6 mA
Max. OFF voltage/current	2 V DC/1.5 mA
Input impedance	Approx. 6.8 kΩ
Min. input pulse width	500 μ s

(Note 1) Terminal numbers B4 and B13 are common for the Near home input, Over limit input (+), Over limit input (-) and Positioning control start input.

3.9 Connections of Pulse Input

3.9.1 Line Driver Type

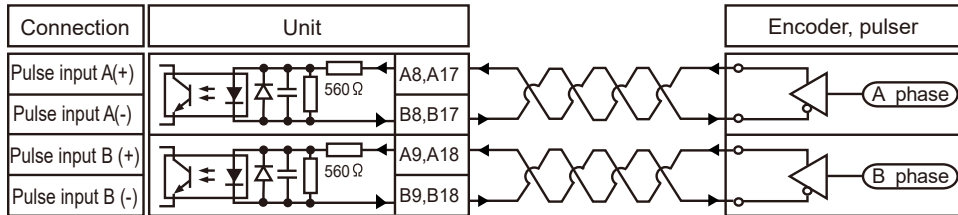

3.9.2 Transistor Open Collector Type

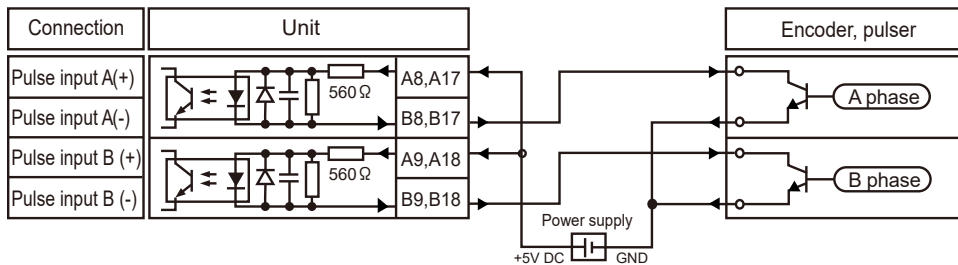

3.9.3 Transistor-resistor Pull-up Type

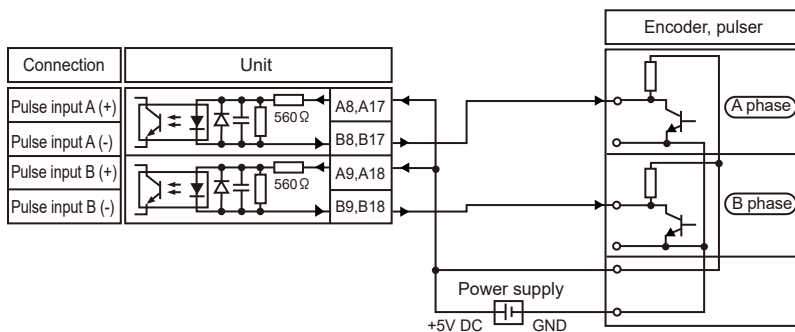

i Info.

- As the same pulser input terminal is used for pulser input operation and feedback pulse count, either function of the two can only be used.
- When counting the 2-phase input such as the input from the encoder, set the pulse input transfer multiple to "4 multiple setting" ($\times 4$) or "2 multiple setting" ($\times 2$) to prevent counting error. The pulse input transfer multiple is specified using the Pulse_4Axes parameters.

(MEMO)

4 Project Creation and Parameter Description

4.1 Adding Expansion Units.....	4-2
4.2 Performing Parameter Settings.....	4-5
4.3 List of Pulse_4Axes Parameters.....	4-6
4.4 Function Blocks Used for the Pulse Output Unit.....	4-8
4.5 Increment and Absolute	4-9
4.6 Selection of Acceleration / Deceleration Method	4-11
4.7 Servo ON Output	4-12
4.7.1 Controlling Servo ON Output	4-12
4.7.2 Checking Servo ON Output	4-12
4.8 Internal Absolute Counter	4-13
4.8.1 Functions of Internal Absolute Counter.....	4-13
4.8.2 How the Internal Absolute Counter Operates	4-13
4.8.3 Reading Elapsed Value	4-13
4.8.4 Writing Elapsed Value	4-14

4.1 Adding Expansion Units

4.1 Adding Expansion Units

This section explains how to add device objects for expansion units to a project. After the addition, the parameters and I/O mapping can be checked or changed.

The following explanation is provided for a case where a digital input unit (product number: AGM1X64D2) is added to Empty1.

The procedure is as follows:

1 2 Procedure

1. Right-click the [Empty1] object in the navigation pane and then select "Unit Management" from the context-sensitive menu that is displayed.

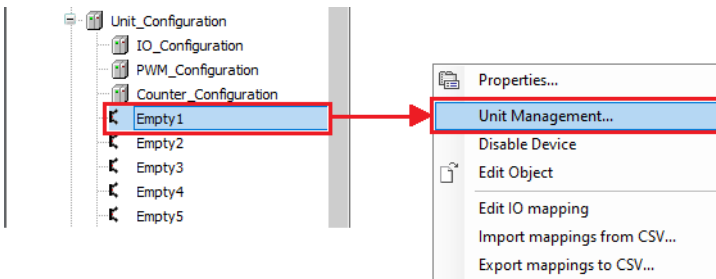

The "Unit Management" dialog box will be displayed.

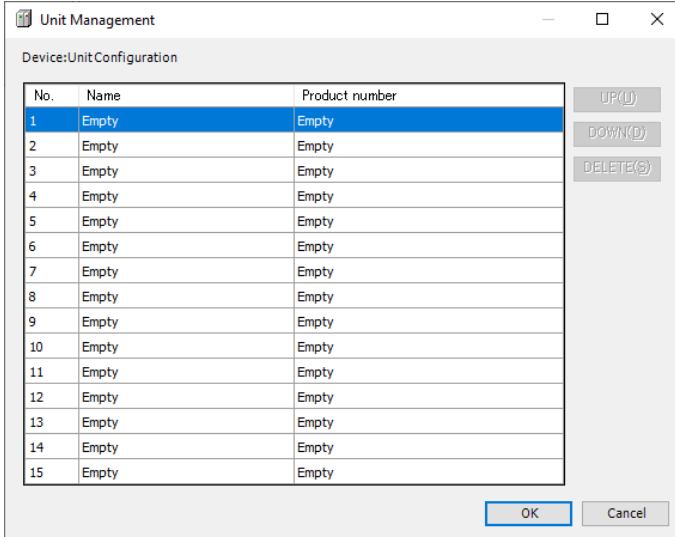

2. Double-click the first row in the "Device: Unit_Configuration" table. The "Select Device" dialog box will be displayed.

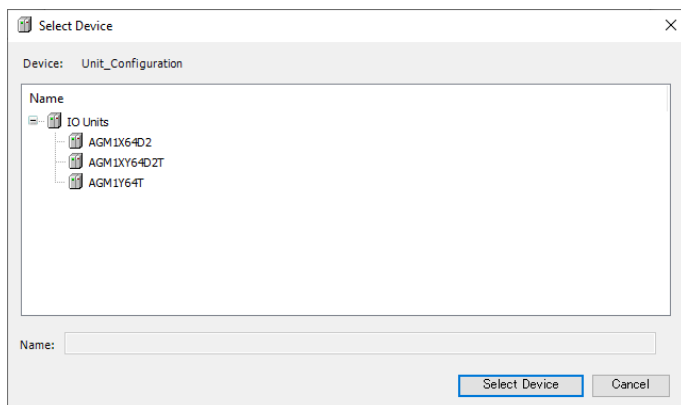

3. Select a device object for the expansion unit to be added.

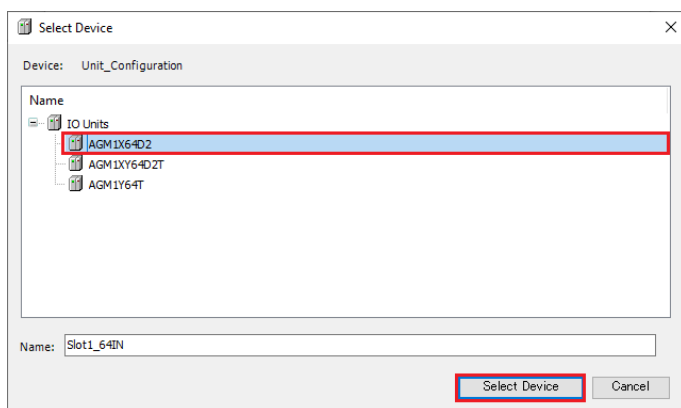

4. Click the [Select Device] button.
The selected device object of the expansion unit will be added.

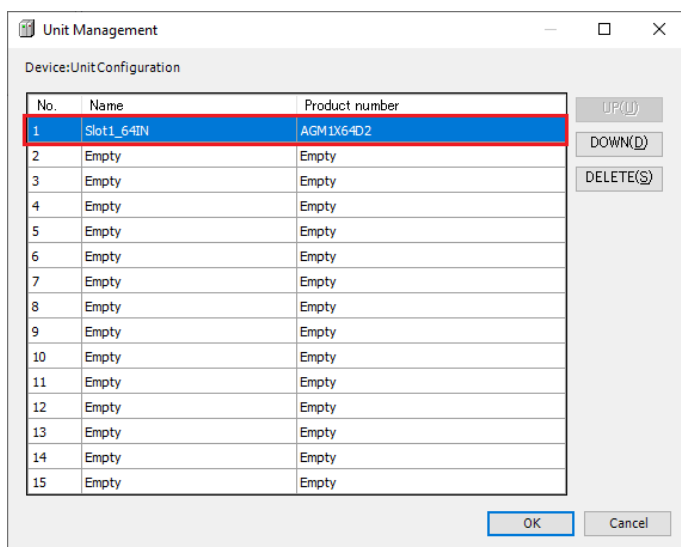

5. Click the [OK] button.

4.1 Adding Expansion Units

The selected device object of the expansion unit will be added to the navigation pane.

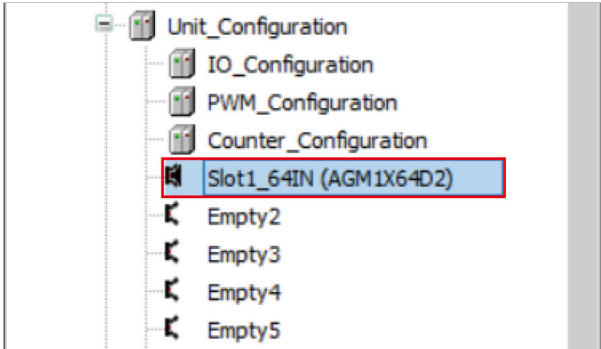

6. Double-click the added object.

The setting pane will be displayed in the main pane. Specify settings related to the expansion unit.

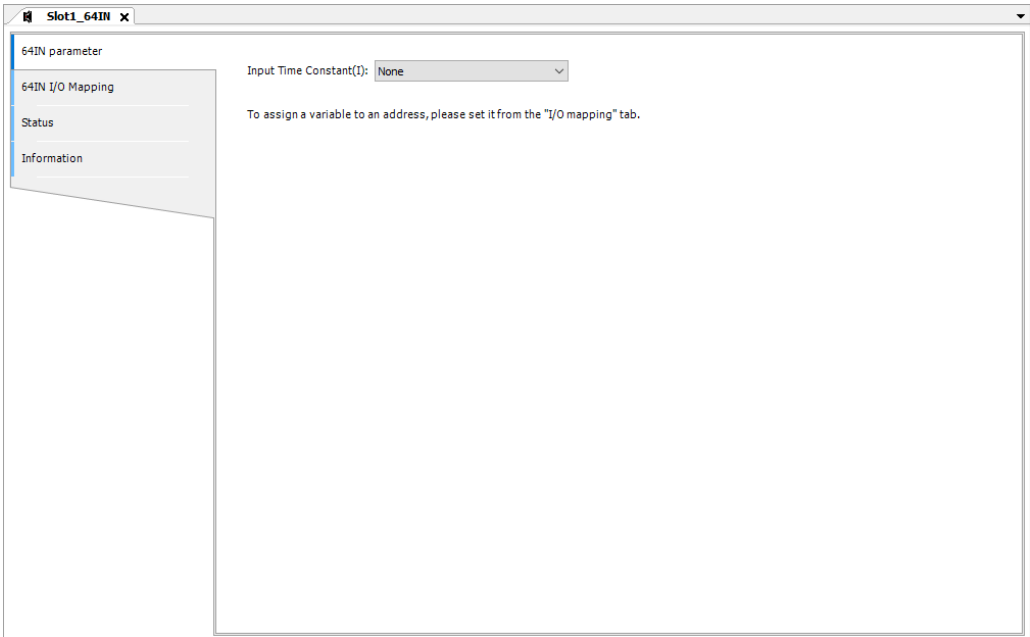

i Info.

- To remove the device object of an expansion unit that has been added, select the expansion unit to be removed in the "Unit Management" dialog box and press the "Delete" key or click the [Delete] button.

4.2 Performing Parameter Settings

Specify operation of the positioning unit by setting parameters.

■ Overview

- After adding a pulse output unit to the project, select the unit from the device pane to set its parameters.
- The pulse output units are displayed as follows in the device pane.

Pulse output unit (Line driver output type)	Slot*_Pulse_4Axes (AGM1PG04L)
Pulse output unit (Transistor output type)	Slot*_Pulse_4Axes (AGM1PG04T)

(Note 1) The segments indicated by * differ according to the expansion location.

1 2 Procedure

Changing parameters of the pulse output unit connected to the 1st unit

1. Double-click "Slot1_Pulse_4Axes (AGM1PG04L)" in the device pane.

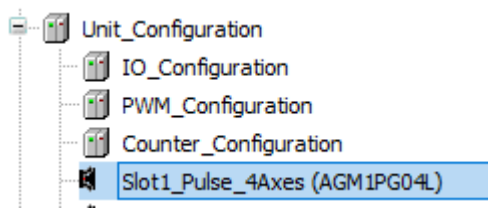

2. Click the "Pulse_4Axes Parameters" tab.
3. Change the Parameter for every channel.

Parameter setting example

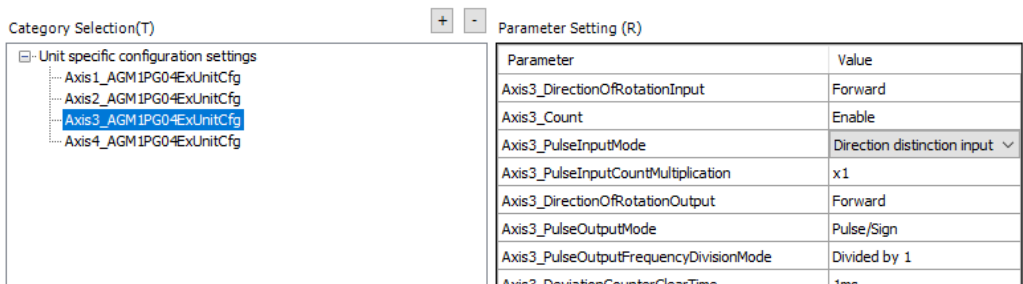

(Note 1) In this example, the pulse input mode for the 3rd axis is set to "Direction distinction input".

Note

- For the description of parameters to be set, see the next page.

4.3 List of Pulse_4Axes Parameters

4.3 List of Pulse_4Axes Parameters

The following table shows a list of changeable parameters for the GM1 Pulse Output Unit.

- Set parameter for each axis.
- Parameters are common to the line driver output type and the transistor output type.

Parameter	Default	Set value
DirectionOfRotationInput (Pulse input rotation direction)	Forward	Forward Reverse
Count (Pulse input count)	Enable	Enable Disable
PulseInputMode (Pulse input mode)	2-phase input	2-phase input Direction distinction input Individual input
PulseInputCountMultiplication (Pulse input transfer multiple)	x1	x1 x2 x4
DirectionOfRotationOutput (Pulse output rotation direction)	Forward	Forward Reverse
PulseOutputMode (Pulse output mode)	Pulse/Sign	Pulse/Sign CW/CCW
PulseOutputFrequencyDivisionMode (Pulse output divided mode)	Divided by 1	Divided by 1 Divided by 2 Divided by 4 Divided by 8 Divided by 16 Divided by 32 Divided by 64 Divided by 128
DeviationCounterClearTime (Deviation counter clear time)	1 ms	1 ms 10 ms
AccelerationDecelerationMethod (Acceleration / Deceleration method)	Linear Acceleration / Deceleration	Linear Acceleration / Deceleration S Acceleration / Deceleration
OriginReturnDirection (Home return direction)	(-) Direction of the elapsed value	(-) Direction of the elapsed value (+) Direction of the elapsed value
StartUp Time (Startup time)	0.02 ms	0.02 ms 0.005 ms 0.001 ms
OriginInputLogic (Home input logic)	Normal Close	Normal Close Normal Open
OriginNeighborhoodLogic (Near home logic)	Normal Close	Normal Close Normal Open
OriginSearch (Home search)	Disable	Disable Enable

4.3 List of Pulse_4Axes Parameters

Parameter	Default	Set value
LimitInputLogic (Over limit input logic)	Normal Close	Normal Close Normal Open
SShapedPattern (S-shaped pattern)	Sine curve	Sine curve Cubic curve
PulseInOutMultiplication (Pulser input, pulse output transfer multiple)	x1	x1 x2 x5 x10 x50 x100 x500 x1000
StartupSpeed (Startup speed [u/s])	0	0 to 4294967295
PulseInputAorBSignalInCnst (Pulse input A/B signal time constant)	Not InCnst	Not InCnst 0.1 us 0.5 us 1.0 us 2.0 us 10.0 us
OriginInputInCnst (Home input time constant)	Not InCnst	Not InCnst 10.0 us 100.0 us

4.4 Function Blocks Used for the Pulse Output Unit

4.4 Function Blocks Used for the Pulse Output Unit

The pulse output unit is controlled by function blocks.

For the detailed specifications of each function block, refer to the *GM1 Series Reference Manual (Instruction Edition)*.

Function block name	Description
PG_Power	Servo ON or OFF
PG_Jog	JOG operation
PG_MoveAbsolute	Absolute positioning (E-point control and P-point control)
PG_MoveRelative	Relative positioning (E-point control and P-point control)
PG_LatchPosition	JOG positioning
PG_Stop	Forced stop and deceleration stop
PG_Pulser	Pulser operation ON / OFF
PG_SetPosition	Current position change
PG_Home	Home return
PG_WriteParameter	Parameter setting
PG_ReadParameter	Parameter acquisition
PG_ReadStatus	Status acquisition
PG_ClearError	Clearing errors

4.5 Increment and Absolute

■ Difference in how it is specified

- Increment (relative value control)
 - Specify the relative distance from the current position. Specify a positive value to control in the positive direction.
 - Use the "Distance" input of the "PG_MoveRelative" function block.
- Absolute (absolute value control)
 - Specify the target position regardless of the current position. Always specify the target position as the absolute position from the home position.
 - Use the "Position" input of the "PG_MoveAbsolute" function block.

■ Specifying examples

The following describes an example for moving from the current position (+20000) to a new position (+30000) and then to another position (+24000).

- Increment (relative value control)
 1. Specify "Distance = 10000" and execute "PG_MoveRelative".

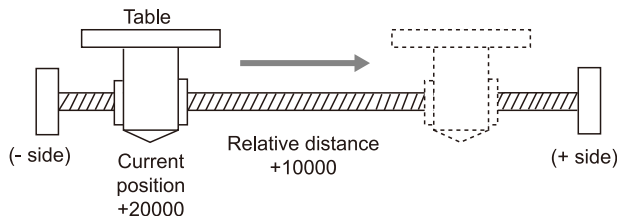

2. When the above operation is completed, specify "Distance = -6000" and execute "PG_MoveRelative".

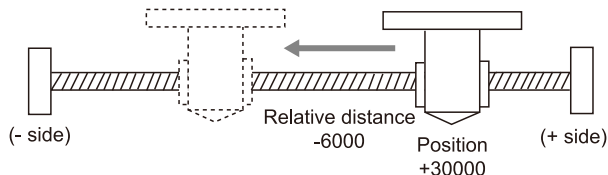

- Absolute (absolute value control)
 1. Specify "Position = 30000" and execute "PG_MoveAbsolute".

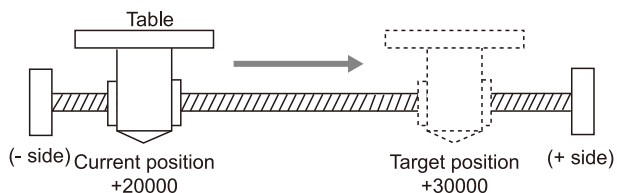

2. When the above operation is completed, specify "Position = 24000" and execute "PG_MoveAbsolute".

4.5 Increment and Absolute

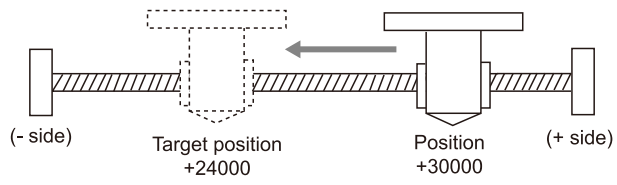

4.6 Selection of Acceleration / Deceleration Method

There are the following two acceleration / deceleration methods: "Linear acceleration / deceleration" and "S acceleration / deceleration"

Linear Acceleration / Deceleration

With linear acceleration / deceleration, acceleration and deceleration between the startup speed and the target speed are carried out in a straight line. Acceleration and deceleration take place at the acceleration/deceleration set in function blocks.

S Acceleration / Deceleration

With S acceleration/deceleration, acceleration and deceleration between the startup speed and the target speed are carried out in a curve line.

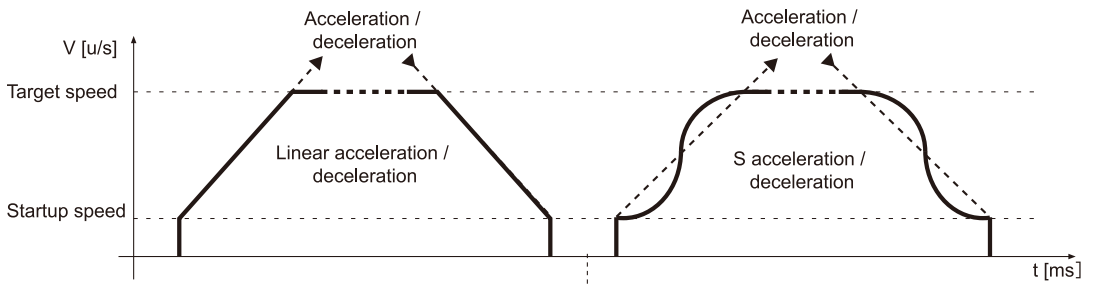

■ **S Acceleration / deceleration patterns**

- "Sine curve", and "Cubic curve" are available for S acceleration / deceleration.
- The curve degree increases in the following order: Cubic curve > Sine curve

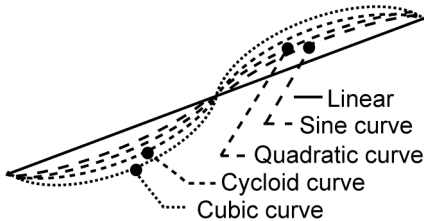

4.7 Servo ON Output

4.7 Servo ON Output

4.7.1 Controlling Servo ON Output

- The servo ON is controlled by the PG_Power function block.
- Even when the mode is switched to the STOP mode, the servo is not automatically set to the servo OFF state. Use the PG_Power function block to set to the servo OFF state.

4.7.2 Checking Servo ON Output

The state of the servo ON output of the unit can be checked using the Status output parameter of the PG_Power function block.

- TRUE: The axis can be executed.
- FALSE: The axis cannot be executed.

■ Program example (ST)

Declaration section

```
PROGRAM sample
VAR
    PG_Power_0: PG_Power;
END_VAR
```

Implementation section

```
PG_Power_0(
    UnitID:=1,
    AxisNo:=1,
    Enable:=TRUE,
    bRegulatorOn:=TRUE);
PG_Power_0.Status;
```

4.8 Internal Absolute Counter

4.8.1 Functions of Internal Absolute Counter

- The pulse output unit is equipped with a function that counts the number of pulses output.
- The counted value of each axis is stored in the axis as the elapsed data indicating the absolute position from the home position. The value can be read using the PG_ReadStatus function block.

4.8.2 How the Internal Absolute Counter Operates

- When the power supply is turned OFF, the counter value is set to zero (0).
- When the table returns to the home position by a home return, the counter value automatically becomes zero (0).
- If the elapsed value exceeds the maximum (or minimum) value, it returns to the minimum (maximum) value. The pulse output does not stop if this occurs, and no error occurs.

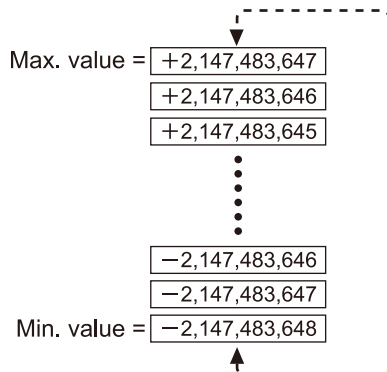

4.8.3 Reading Elapsed Value

- The elapsed value can be read using the AbsoluteCounter output parameter of the PG_ReadStatus function block.

■ Program example (ST)

Declaration section

```
PROGRAM sample
VAR
  PG_ReadStatus_0: PG_ReadStatus;
END_VAR
```

Implementation section

```
PG_ReadStatus_0(
  UnitID:=1,
```

4.8 Internal Absolute Counter

```
AxisNo:=1,  
Enable:=TRUE);  
PG_ReadStatus_0.AbsoluteCounter;
```

4.8.4 Writing Elapsed Value

- The elapsed value can be written using the PG_SetPosition function block.
- In the following example, the elapsed value "10000" is written.

■ Program example (ST)

Declaration section

```
PROGRAM sample  
VAR  
    PG_SetPosition_0: PG_SetPosition;  
END_VAR
```

Implementation section

```
PG_SetPosition_0(  
    UnitID:=1,  
    AxisNo:=1,  
    Execute:=TRUE,  
    PositionType:=PG_POSITION_TYPE.ABSOLUTE,  
    AbsoluteCounter:=10000);
```

5 Power ON and OFF, and Items to Check

5.1 Safety Circuit Design	5-2
5.2 Items to Check Before Turning ON the Power.....	5-3
5.3 Procedure for Turning On the Power	5-4
5.3.1 Procedure for Turning ON the Power.....	5-4
5.3.2 Procedure for Turning OFF the Power.....	5-4
5.4 Confirming while the Power is ON	5-6
5.4.1 Items to Check when the Power is ON	5-6
5.4.2 Checking the External Safety Circuit	5-6
5.4.3 Checking the Safety Circuit based on Pulse Output Unit.....	5-6
5.4.4 Checking the Operation of the Near Home Switch and Home Switch	5-7
5.4.5 Checking Rotating and Moving Directions and Moving Distance	5-8

5.1 Safety Circuit Design

5.1 Safety Circuit Design

Provide the following safety circuit for the system incorporating the pulse output unit.

■ Example of a safety circuit

Installation of the over limit switch

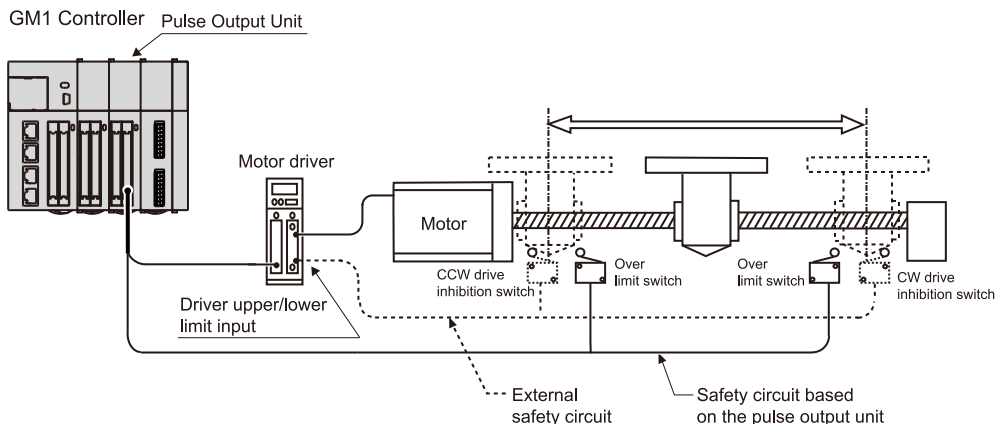

■ Safety circuit based on the pulse output unit

- Install over limit switches as shown above.
- Connect them to the over limit input (+) and over limit input (-) of the pulse output unit.

■ Safety circuit based on external circuit

- Install the safety circuit recommended by the manufacturer of the motor being used.

5.2 Items to Check Before Turning ON the Power

Before turning ON the power to the system incorporating the pulse output unit, check the following points.

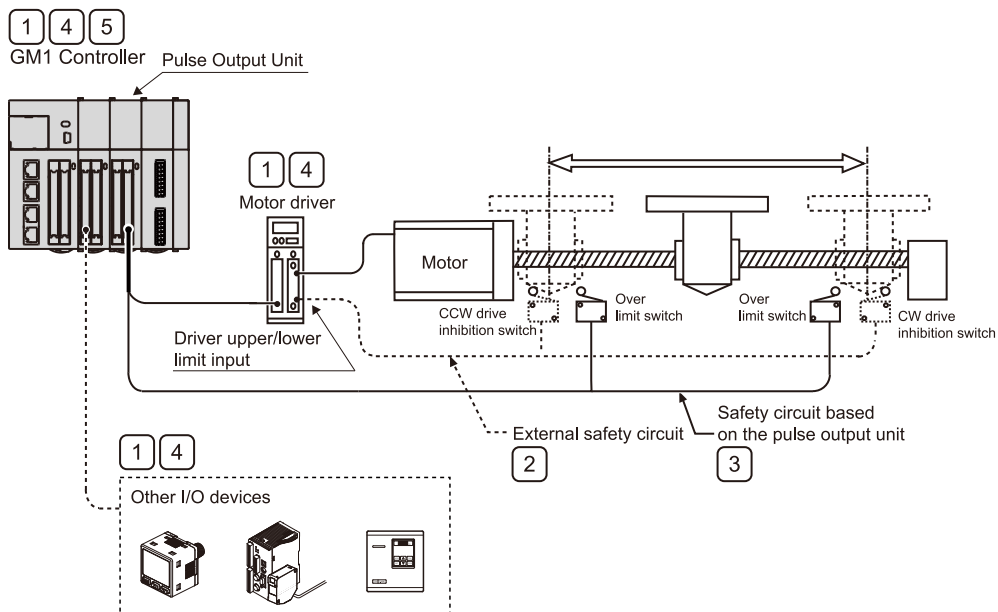

(1) Checking connections of each device

Check to make sure that each device has been connected as indicated by the design.

(2) Checking the installation of the external safety circuit

Check to make sure the safety circuit (wiring and installation of over limit switch) based on the external circuit has been installed properly.

(3) Checking the installation of the safety circuit based on the pulse output unit

Check the connections between the pulse output unit and over limit switches.
Check the installation condition of the over limit switches.

(4) Checking the settings for power ON sequence

Make sure settings have been entered so that power supplies will be turned on according to the procedure outlined in section "Procedure for Turning ON the Power".

(5) Checking the CPU mode selection switch

Set the GM1 Controller to the STOP mode. Setting it in the RUN mode can cause inadvertent operation.

5.3 Procedure for Turning On the Power

5.3 Procedure for Turning On the Power

5.3.1 Procedure for Turning ON the Power

When turning ON the power supply to the system incorporating the pulse output unit, turn ON the power supply in the following order.

Consider the nature and statuses of any external devices connected to the system, and take sufficient care so that turning ON the power supply will not initiate unexpected movements.

1 2 Procedure

1. Turn ON the power supplies for the input and output devices connected to the PLC. (Including the power supply for the line driver output or open collector output)
2. Turn ON the power supply for the PLC.
3. Turn ON the power supply for the motor driver.

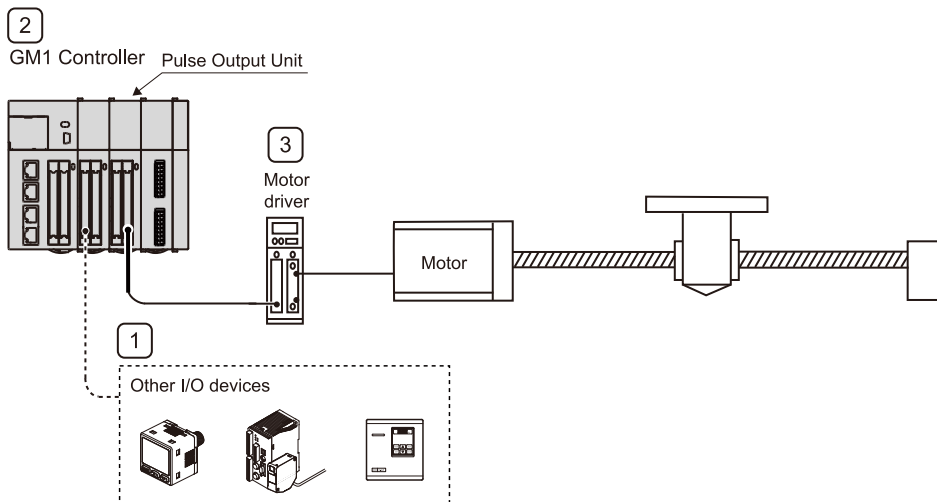

5.3.2 Procedure for Turning OFF the Power

When turning OFF the power supply to the system incorporating the pulse output unit, turn OFF the power supply in the following order.

1 2 Procedure

1. Make sure that the rotation of the motor has stopped, and then turn OFF the power supply for the motor driver.
2. Turn OFF the power supply for the PLC.

3. Turn OFF the power supplies for the input and output devices connected to the PLC.
(Including the power supply for the line driver output or open collector output)

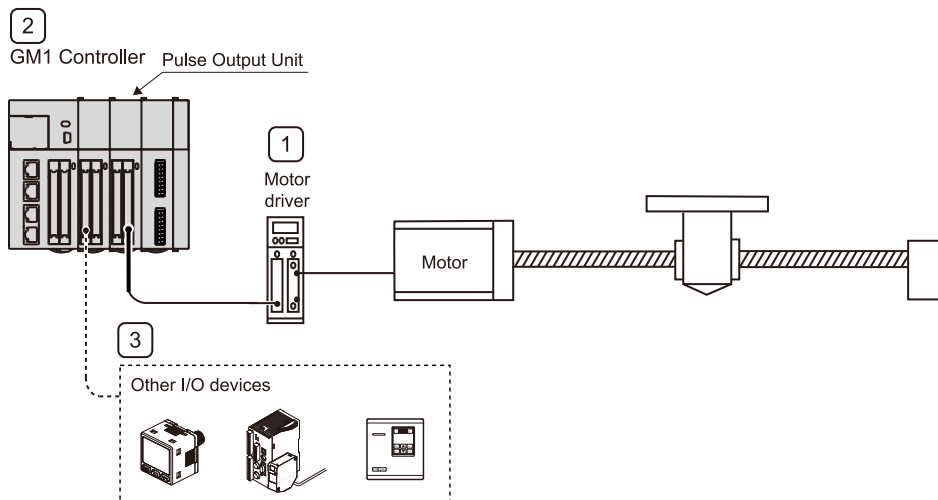

5.4 Confirming while the Power is ON

5.4 Confirming while the Power is ON

5.4.1 Items to Check when the Power is ON

■ System configuration example

When the power to the system incorporating the pulse output unit is turned ON, checking should be carried out in the four general stages described below.

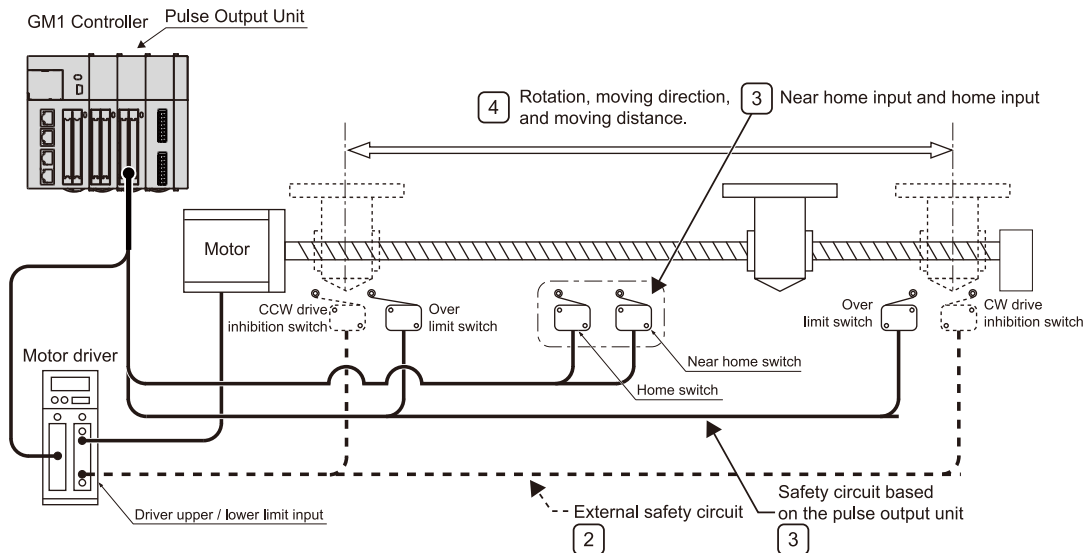

1. Checking the installation of the external safety circuit
2. Checking the installation of the safety circuit based on the pulse output unit
3. Checking the motor's rotation direction, moving direction, and moving distance.
4. Checking the near home input and home input

5.4.2 Checking the External Safety Circuit

Check the safety circuit recommended by the motor manufacturer to confirm the power supply cutoff of the motor driver and other functions by turning ON the CW / CCW driving inhibition switch of an external circuit.

5.4.3 Checking the Safety Circuit based on Pulse Output Unit

1.2 Procedure

1. Perform a forced operation on the over limit switch for the safety circuit of the positioning unit
 - 1-1 Check to see if the over limit input is being properly taken into the pulse output unit.

i Info.

- Whether or not the over limit input is taken can be confirmed by the input contact.
- The over limit input valid logics can be changed using "Pulse_4Axes Parameters".

2. If necessary, input a program to start the JOG operation.

2-1 Forcibly operate the over limit input to check whether the motor will stop.

2-2 Check to see if the over limit switch is functioning properly.

Operation at over limit input

Condition	Direction	Limit status	Operation
When JOG operation is started	Forward	Over limit input (+): ON	Not executable, Error occurs.
		Over limit input (-): ON	Executable
	Reverse	Over limit input (+): ON	Executable
		Over limit input (-): ON	Not executable, Error occurs.
During JOG operation	Forward	Over limit input (+): ON	Deceleration stop, Error occurs.
	Reverse	Over limit input (-): ON	Deceleration stop, Error occurs.

REFERENCE

[4.3 List of Pulse_4Axes Parameters](#)

5.4.4 Checking the Operation of the Near Home Switch and Home Switch**1 2 Procedure**

1. Perform a forced operation on the home input and near home input.

1-1 Check to make sure the operation display LEDs on the pulse output unit light.

1-2 Execute "PG_Home" to check the operation.

2. Input the home return program and actually carry out a home return.

2-1 Check if near home input produces deceleration.

i Info.

- The input valid logic for the home input and near home input is set in "Pulse_4Axes Parameters"

3. Repeat JOG operation and home return operation.

3-1 Check if the home stop position deviates.

3-2 If the home stop position deviates, make adjustment so that the home position does not deviate.

5.4 Confirming while the Power is ON

1. Change the position of the near home input.
2. Reduce the home return speed.

i Info.

- Deviation may occur depending on the position of the near home input and home input or the home return speed.

REFERENCE

[4.3 List of Pulse_4Axes Parameters](#)

5.4.5 Checking Rotating and Moving Directions and Moving Distance

1 2 Procedure

1. Execute the JOG operation to confirm that the rotating direction and moving direction of the motor are correct.

i Info.

- The rotating direction is determined according to the installation of the ball screw or the "CW/CCW direction setting" option of "Pulse_4Axes Parameters".

2. Confirm whether the moving distance is as designed or not by the position control.

i Info.

- The moving distance is determined according to the pitch of the ball screw, deceleration gear ratio, or setting movement amount of the positioning data.

REFERENCE

[4.3 List of Pulse_4Axes Parameters](#)

6 E Point Control: Single-Speed Acceleration / Deceleration

6.1 Sample Program	6-2
6.1.1 Increment (Relative Value Control)	6-2
6.1.2 Absolute (Absolute Value Control)	6-4
6.2 Over Limit Input.....	6-7
6.3 Precautions on Programming	6-8

6.1 Sample Program

6.1 Sample Program

6.1.1 Increment (Relative Value Control)

This section describes a program example for specifying increment (relative value control) using the E-point control.

- Use the PG_MoveRelative function block.
- E-point control is performed by setting the ContinuousFlag of the input argument to FALSE.
- Specify a relative distance in the Distance input parameter. Specify a positive value in Distance to control in the positive direction.
- The following describes an example for moving from the current position (+20000) to a new position with a relative distance (+10000).

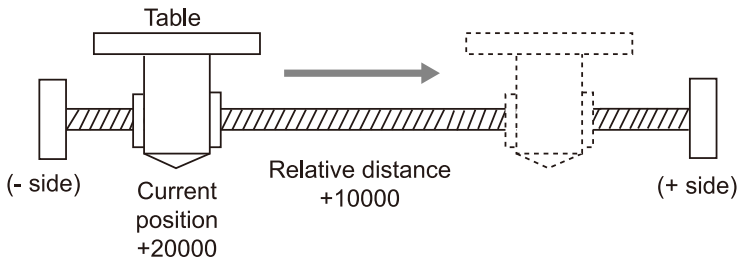

■ Pulse output diagram

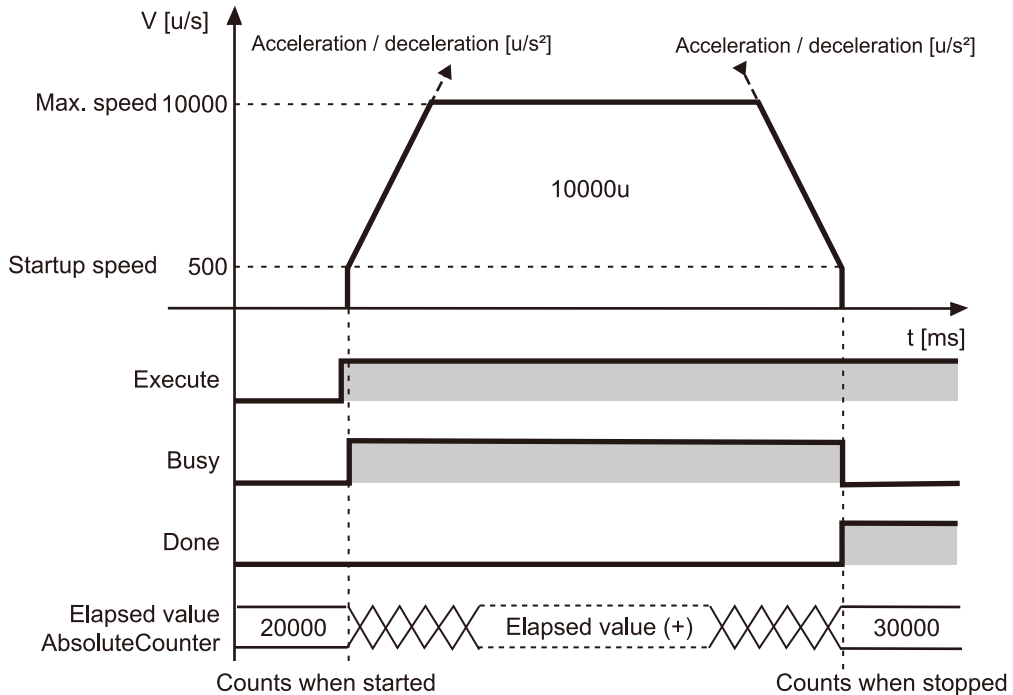

■ Parameter setting

Parameters for the pulse output unit (Pulse_4Axes parameters)

Set from the GM Programmer. Double-click "Slot*_Pulse_4Axes (AGM1PG)" in the device pane.

Parameter	Set value	Setting range
StartupSpeed (Startup speed [u/s])	500	0 to 4000000

PG_MoveRelative parameter

Parameter	Set value	Setting range
Target speed: Velocity [u/s]	10000	0 to 4000000
Acceleration / Deceleration: AccDec [u/s ²]	100000	1 or more ^(Note 1)
Relative distance: Distance [u]	10000	-2147483648 to 2147483647

(Note 1) Set each acceleration / deceleration time to 32767 ms or less.

■ Program (ST)

Declaration section

```
PROGRAM sample
VAR
    Process :UDINT := 0;
    PG_Power_0: PG_Power;
    PG_MoveRelative_0: PG_MoveRelative;
END_VAR
```

Implementation section

```
CASE Process OF
    0://Servo On
        PG_Power_0(
            UnitID:=1,
            AxisNo:=1,
            Enable:=TRUE,
            bRegulatorOn:=TRUE);
        IF PG_Power_0.Status = TRUE THEN
            Process := 1;
        END_IF
    1://Execute the PG_MoveRelative
        PG_MoveRelative_0(
            UnitID:=1,
            AxisNo:=1,
            Execute:=TRUE,
            Distance:= 10000,
            Velocity:=10000,
            AccDec:=100000,
```

6.1 Sample Program

```

ContinuousFlag:=FALSE);
END_CASE

```

6.1.2 Absolute (Absolute Value Control)

This section describes a program example for specifying absolute (absolute value control) using the E-point control.

- Use the PG_MoveAbsolute function block.
- E-point control is performed by setting the ContinuousFlag of the input argument to FALSE.
- Specify the target position in the Position input parameter and execute the function block. The table will move to the target position regardless of the current position.
- The following describes an example for moving from the current position (+20000) to a target position (+30000).

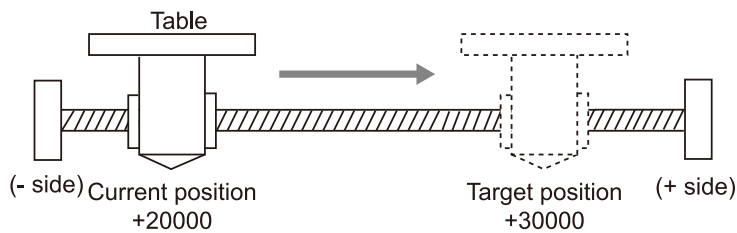

■ Pulse output diagram

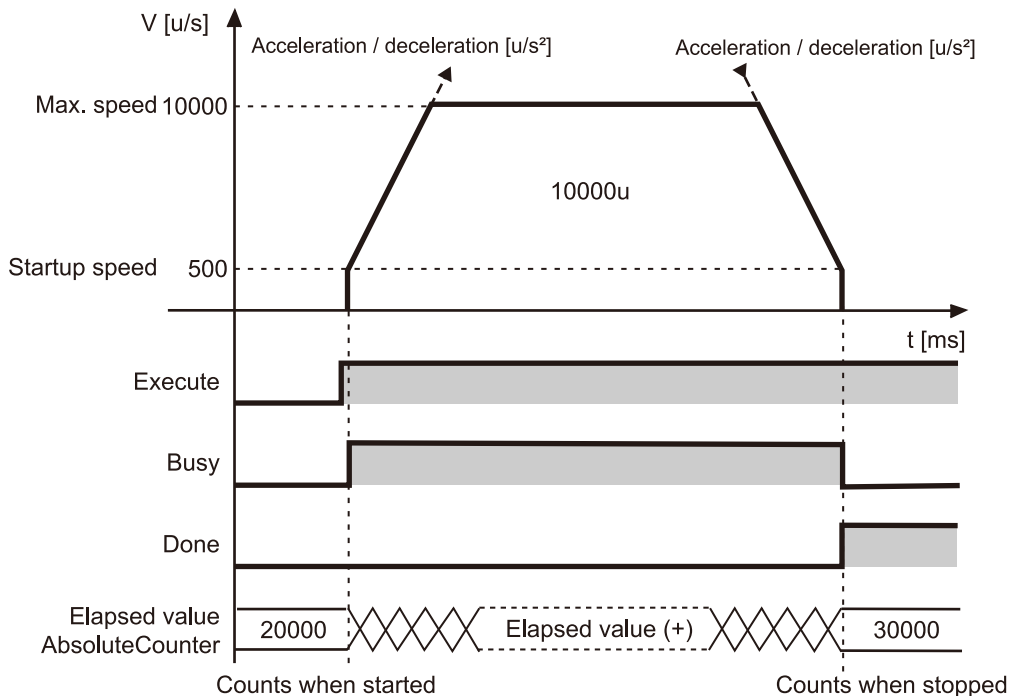

■ Parameter Settings

Parameters for the pulse output unit (Pulse_4Axes parameters)

Set from the GM Programmer. Double-click "Slot*_Pulse_4Axes (AGM1PG)" in the device pane.

Parameter	Set value	Setting range
StartupSpeed (Startup speed [u/s])	500	0 to 4000000

PG_MoveAbsolute parameter

Parameter	Set value	Setting range
Target speed: Velocity [u/s]	10000	0 to 4000000
Acceleration / Deceleration: AccDec [u/s ²]	100000	1 or more ^(Note 1)
Target position: Position [u]	30000	-2147483648 to 2147483647

(Note 1) Set each acceleration / deceleration time to 32767 ms or less.

■ Program (ST)

Declaration section

```
PROGRAM sample
VAR
    Process :UDINT := 0;
    PG_Power_0: PG_Power;
    PG_MoveAbsolute_0: PG_MoveAbsolute;
END_VAR
```

Implementation section

```
CASE Process OF
    0://Servo On
        PG_Power_0(
            UnitID:=1,
            AxisNo:=1,
            Enable:=TRUE,
            bRegulatorOn:=TRUE);
        IF PG_Power_0.Status = TRUE THEN
            Process := 1;
        END_IF
    1://Execute the PG_MoveAbsolute
        PG_MoveAbsolute_0(
            UnitID:=1,
            AxisNo:=1,
            Execute:=TRUE,
            Position:= 30000,
            Velocity:=10000,
            AccDec:=100000,
```

6.1 Sample Program

```
ContinuousFlag:=FALSE);  
END_CASE
```

6.2 Over Limit Input

■ Operation at over limit input

Operations depend on the status of over limit input (+) and over limit input (-) as follows.

Condition	Direction	Limit status	Operation
When E-point control is started	Forward	Over limit input (+): ON	Not executable, Error occurs.
		Over limit input (-): ON	Not executable, Error occurs.
	Reverse	Over limit input (+): ON	Not executable, Error occurs.
		Over limit input (-): ON	Not executable, Error occurs.
While E-point control is being performed	Forward	Over limit input (+): ON	Stop, Error occurs.
		Over limit input (-): ON	Stop, Error occurs.
	Reverse	Over limit input (-): ON	Stop, Error occurs.
		Over limit input (-): ON	Stop, Error occurs.

■ Input valid logic of over limit input

- When the over limit switches (+) (-) are not connected to the pulse output unit, change the input valid logic of the over limit switch to "NO contact". The default is "NC contact", and an over limit error occurs.

6.3 Precautions on Programming

■ Common precautions to each operation

- If the values for the startup speed, target speed, acceleration / deceleration, or position command value exceed the range of values which can be specified, a function block error will occur, and operation cannot be initiated.
- With the GM1 pulse output unit, specify the speed (startup speed and target speed) in the unit of "u/s". 1 u/s = 1 pps

7 P Point Control: Multi-Stage Acceleration / Deceleration

7.1 Sample Program	7-2
7.1.1 Increment (Relative Value Control)	7-2
7.1.2 Absolute (Absolute Value Control)	7-6
7.2 Operation at Over Limit Input.....	7-9
7.3 Precautions On Programming.....	7-10

7.1 Sample Program

7.1 Sample Program

7.1.1 Increment (Relative Value Control)

This section describes a program example for specifying increment (relative value control) using the P-point control.

- Specify a positive value in the Distance input parameter of the PG_MoveRelative function block and execute it.
- P-point control is performed by setting the ContinuousFlag of the input argument to TRUE.
- Set the 2nd and 3rd speeds at the timing when the ContinuousEnable output parameter turns TRUE.
- In the final 3rd speed, the target speed is set to the same value as the start speed, and after deceleration, the target position is reached at the start speed.
- The following describes an example for moving as shown below from the current position (+10000).

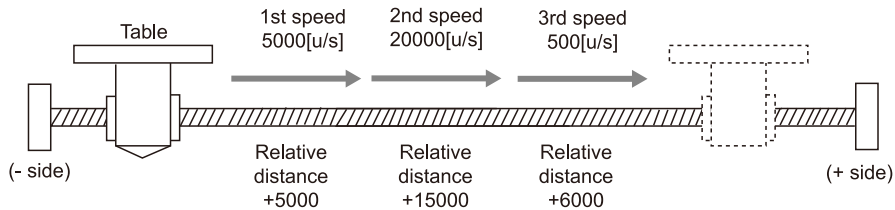

■ Pulse output diagram

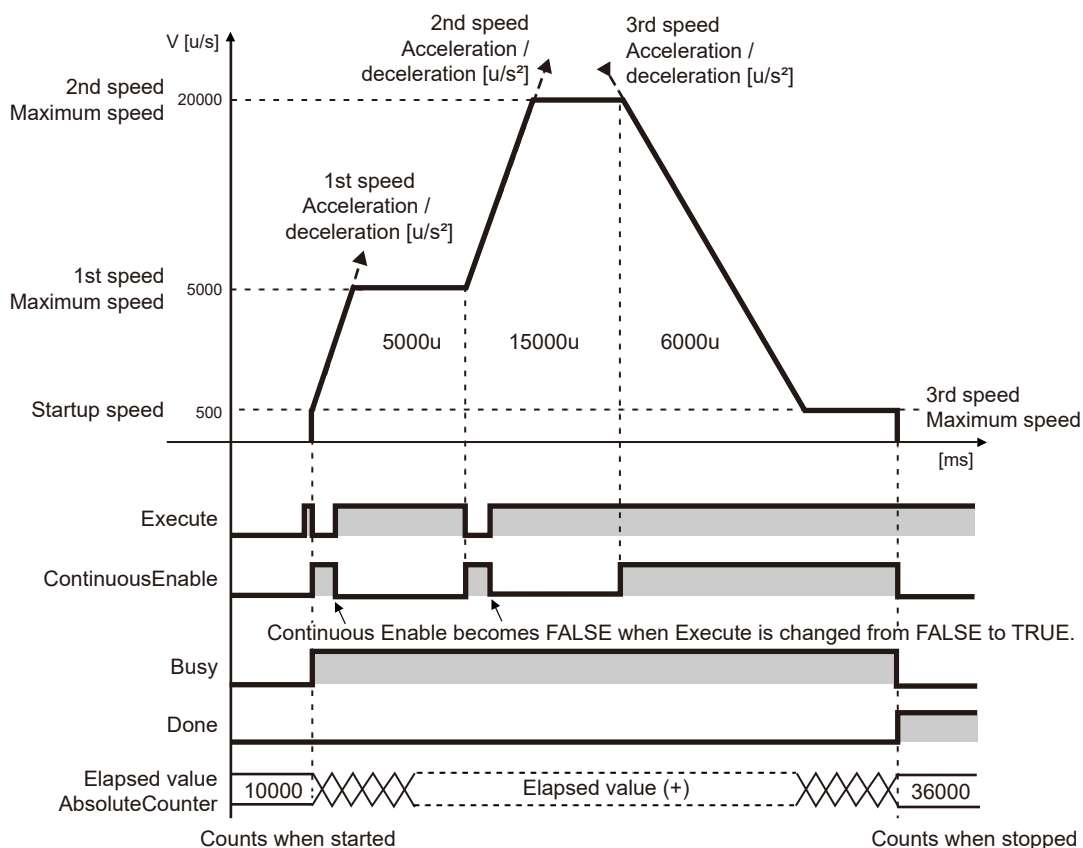

■ Parameter settings

Parameters for the pulse output unit (Pulse_4Axes parameters)

Set from the GM Programmer. Double-click "Slot*_Pulse_4Axes (AGM1PG)" in the device pane.

Parameter	Set value	Setting range
StartupSpeed (Startup speed [u/s])	500	0 to 4294967295

PG_MoveRelative parameter

Parameter	Set value			Setting range
	1st speed	2nd speed	3rd speed	
Target speed: Velocity [u/s]	5000	20000	500	0 to 4000000
Acceleration / Deceleration: AccDec [u/s ²]	45000	150000	39000	1 or more ^(Note 1)
Relative distance: Distance [u]	5000	15000	6000	-2147483648 to 2147483647

7.1 Sample Program

(Note 1) Set each acceleration / deceleration time to 32767 ms or less.

■ Sample program (ST)

Declaration section

```
PROGRAM sample
VAR
  Process :UDINT := 0;
  PG_Power_0: PG_Power;
  PG_MoveRelative_0: PG_MoveRelative;
END_VAR
```

Implementation section

```
CASE Process OF
  0://Servo On
    PG_Power_0(
      UnitID:=1,
      AxisNo:=1,
      Enable:=TRUE,
      bRegulatorOn:=TRUE);
    IF PG_Power_0.Status = TRUE THEN
      Process := 1;
    END_IF
  1://Execute the 1st PG_MoveRelative
    PG_MoveRelative_0(
      UnitID:=1,
      AxisNo:=1,
      Execute:=TRUE,
      Distance:= 5000,
      Velocity:=5000,
      AccDec:=45000,
      ContinuousFlag:=TRUE);
    IF PG_MoveRelative_0.ContinuousEnable = TRUE THEN
      PG_MoveRelative_0(
        UnitID:=1,
        AxisNo:=1,
        Execute:=FALSE);
      Process := 2;
    END_IF
  2://Execute the 2nd PG_MoveRelative
    PG_MoveRelative_0(
      UnitID:=1,
      AxisNo:=1,
      Execute:=TRUE,
      Distance:= 15000,
      Velocity:=20000,
      AccDec:=150000,
      ContinuousFlag:=TRUE);
    IF PG_MoveRelative_0.ContinuousEnable = TRUE THEN
      PG_MoveRelative_0(
        UnitID:=1,
        AxisNo:=1,
        Execute:=FALSE);
      Process := 3;
```

```
END_IF
3://Execute the 3rd PG_MoveRelative
  PG_MoveRelative_0(
    UnitID:=1,
    AxisNo:=1,
    Execute:=TRUE,
    Distance:= 6000,
    Velocity:=500,
    AccDec:=39000,
    ContinuousFlag:=TRUE);
END_CASE
```

7.1 Sample Program

7.1.2 Absolute (Absolute Value Control)

This section describes a program example for specifying absolute (absolute value control) using the P-point control.

- Specify a positive value in the Position input parameter of the PG_MoveAbsolute function block and execute it.
- P-point control is performed by setting the ContinuousFlag of the input argument to TRUE.
- Set the 2nd and 3rd speeds at the timing when the ContinuousEnable output parameter turns TRUE.
- In the final 3rd speed, the target speed is set to the same value as the start speed, and after deceleration, the target position is reached at the start speed.
- The following describes an example for moving as shown below from the current position (+10000).

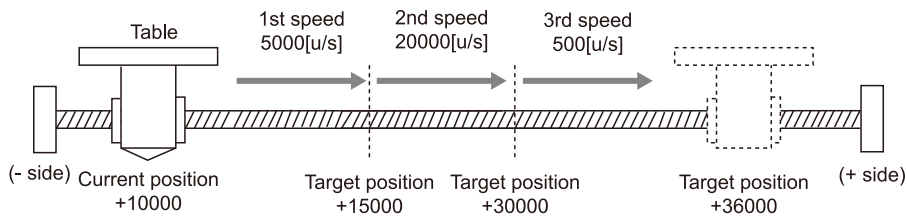

■ Pulse output diagram

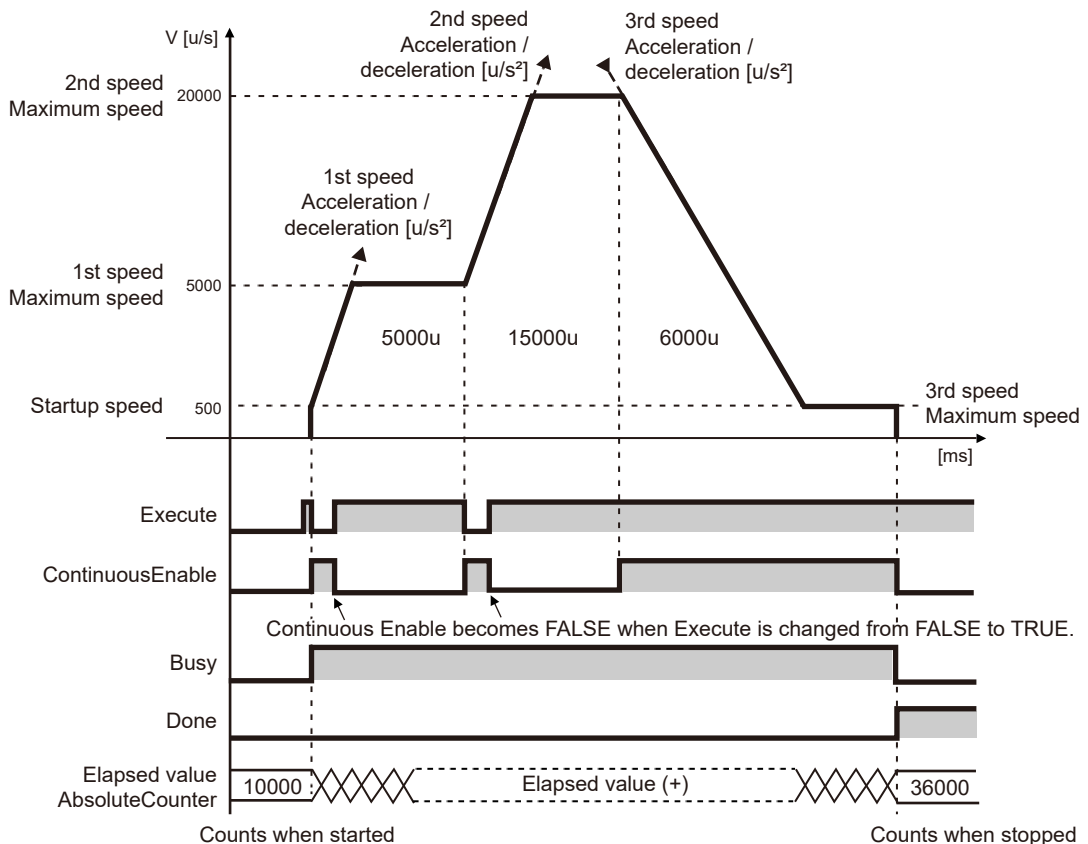

■ Parameter settings

Parameters for the pulse output unit (Pulse_4Axes parameters)

Set from the GM Programmer. Double-click "Slot*_Pulse_4Axes (AGM1PG)" in the device pane.

Parameter	Set value	Setting range
StartupSpeed (Startup speed [u/s])	500	0 to 4294967295

PG_MoveAbsolute parameter

Parameter	Set value			Setting range
	1st speed	2nd speed	3rd speed	
Target speed: Velocity [u/s]	5000	20000	500	0 to 4000000
Acceleration / Deceleration: AccDec [u/s ²]	45000	150000	39000	1 or more ^(Note 1)
Target position: Position [u]	15000	30000	36000	-2147483648 to 2147483647

(Note 1) Set each acceleration / deceleration time to 32767 ms or less.

■ Program (ST)

Declaration section

```
PROGRAM sample
VAR
  Process :UDINT := 0;
  PG_Power_0: PG_Power;
  PG_MoveAbsolute_0: PG_MoveAbsolute;
END_VAR
```

Implementation section

```
CASE Process OF
  0://Servo On
    PG_Power_0(
      UnitID:=1,
      AxisNo:=1,
      Enable:=TRUE,
      bRegulatorOn:=TRUE);
    IF PG_Power_0.Status = TRUE THEN
      Process := 1;
    END_IF
  1://Execute the 1st PG_MoveAbsolute
    PG_MoveAbsolute_0(
      UnitID:=1,
      AxisNo:=1,
      Execute:=TRUE,
      Position:=15000,
      Velocity:=5000,
```

7.1 Sample Program

```
        AccDec:=45000,
        ContinuousFlag:=TRUE);
IF PG_MoveAbsolute_0.ContinuousEnable = TRUE THEN
    PG_MoveAbsolute_0(
        UnitID:=1,
        AxisNo:=1,
        Execute:=FALSE);
    Process := 2;
END_IF
2://Execute the 2nd PG_MoveAbsolute
PG_MoveAbsolute_0(
    UnitID:=1,
    AxisNo:=1,
    Execute:=TRUE,
    Position:=30000,
    Velocity:=20000,
    AccDec:=150000,
    ContinuousFlag:=TRUE);
IF PG_MoveAbsolute_0.ContinuousEnable = TRUE THEN
    PG_MoveAbsolute_0(
        UnitID:=1,
        AxisNo:=1,
        Execute:=FALSE);
    Process := 3;
END_IF
3://Execute the 3rd PG_MoveAbsolute
PG_MoveAbsolute_0(
    UnitID:=1,
    AxisNo:=1,
    Execute:=TRUE,
    Position:=36000,
    Velocity:=500,
    AccDec:=39000,
    ContinuousFlag:=TRUE);
END_CASE
```

7.2 Operation at Over Limit Input

■ Operation at over limit input

Operations depend on the status of over limit input (+) and over limit input (-) as follows.

Condition	Direction	Limit status	Operation
When P-point control is started	Forward	Over limit input (+): ON	Not executable, Error occurs.
		Over limit input (-): ON	Not executable, Error occurs.
	Reverse	Over limit input (+): ON	Not executable, Error occurs.
		Over limit input (-): ON	Not executable, Error occurs.
While P-point control is being performed	Forward	Over limit input (+): ON	Stop, Error occurs.
		Over limit input (-): ON	Stop, Error occurs.
	Reverse	Over limit input (+): ON	Stop, Error occurs.
		Over limit input (-): ON	Stop, Error occurs.

■ Input valid logic of over limit input

- When the over limit switches (+) (-) are not connected to the pulse output unit, change the input valid logic of the over limit switch to "NO contact". The default is "NC contact", and an over limit error occurs.

7.3 Precautions On Programming

■ Common precautions to each operation

- If the values for the startup speed, target speed, acceleration / deceleration, or position command value exceed the range of values which can be specified, a function block error will occur, and operation cannot be initiated.

8 JOG Operation

8.1 Sample Program	8-2
8.1.1 JOG Operation (Forward and Reverse)	8-2
8.1.2 JOG Operation (Speed Changes)	8-4
8.2 Operation at Over Limit Input	8-6
8.3 Precautions on Programming	8-7

8.1 Sample Program

8.1 Sample Program

8.1.1 JOG Operation (Forward and Reverse)

This section describes a program example for switching between forward and reverse rotation during JOG operation.

- Forward and reverse rotation is performed using the external switch.
- Use the PG_Jog function block.

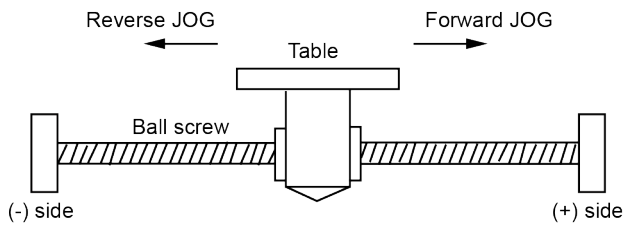

■ Pulse output diagram

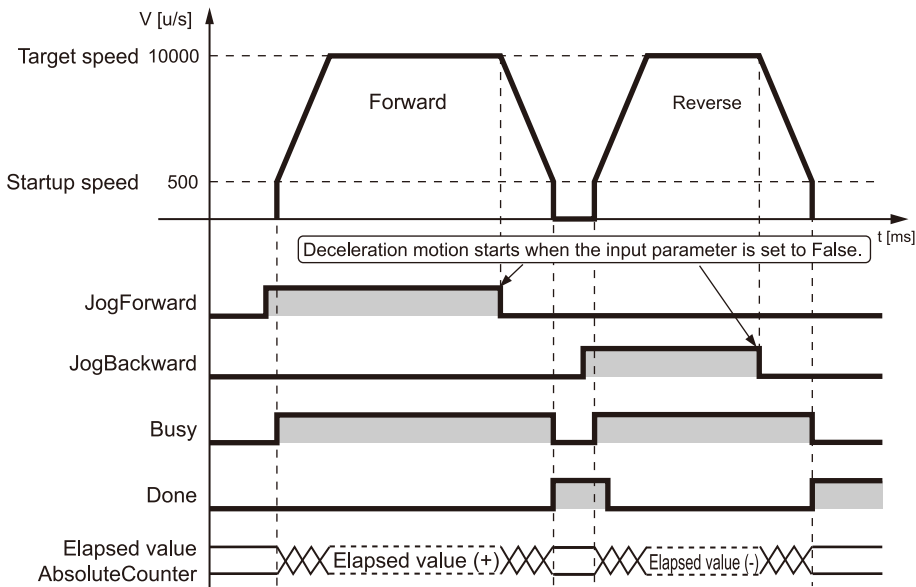

■ Parameter Settings

Parameters for the pulse output unit (Pulse_4Axes parameters)

Set from the GM Programmer. Double-click "Slot*_Pulse_4Axes (AGM1PG)" in the device pane.

Parameter	Set value	Setting range
StartupSpeed (Startup speed [u/s])	500	0 to 4294967295

PG_Jog parameter

Parameter	Set value	Setting range
Target speed: Velocity [u/s]	10000	0 to 4000000
Acceleration / Deceleration: AccDec [u/s ²]	10000	1 or more ^(Note 1)

(Note 1) Set each acceleration / deceleration time to 32767 ms or less.

■ Program (ST)

For forward rotation, set the JogForward input parameter and, for reverse rotation, set the JogBackward input parameter.

The following shows a program to switch from forward rotation to reverse rotation.

Declaration section

```
PROGRAM sample
VAR
    Process :UDINT := 0;
    PG_Power_0: PG_Power;
    PG_Jog_0: PG_Jog;
END_VAR
```

Implementation section

```
CASE Process OF
    0://Servo On
        PG_Power_0(
            UnitID:=1,
            AxisNo:=1,
            Enable:=TRUE,
            bRegulatorOn:=TRUE);
        IF PG_Power_0.Status = TRUE THEN
            Process := 1;
        END_IF
    1://Execute the PG_Jog with JogForward
        PG_Jog_0(
            UnitID:=1,
            AxisNo:=1,
            JogForward:=TRUE,
            JogBackward:=FALSE,
            Velocity:=10000,
            AccDec:=10000);
    2://Changing the variable Process to 2 stop the jog
        PG_Jog_0(
            UnitID:=1,
            AxisNo:=1,
            JogForward:=FALSE,
            JogBackward:=FALSE);
    3://Changing the variable Process to 3 reverses the jog
        PG_Jog_0(
            UnitID:=1,
            AxisNo:=1,
```

8.1 Sample Program

```
JogForward:=FALSE,  
JogBackward:=TRUE,  
Velocity:=10000,  
AccDec:=10000);  
END_CASE
```

8.1.2 JOG Operation (Speed Changes)

The operation speed can be changed during JOG operation. This section describes a program example for changing the speed during forward rotation.

■ Parameter Settings

PG_Jog parameter

Parameter	1st speed	2nd speed	Setting range
Target speed: Velocity [u/s]	10000	20000	0 to 4000000
Acceleration / Deceleration: AccDec [u/s ²]	10000	10000	1 or more ^(Note 1)

(Note 1) Set each acceleration / deceleration time to 32767 ms or less.

■ Program (ST)

● Declaration section

```
PROGRAM sample  
VAR  
  Process :UDINT := 0;  
  PG_Power_0: PG_Power;  
  PG_Jog_0: PG_Jog;  
END_VAR
```

● Implementation section

```
CASE Process OF  
  0://Servo On  
    PG_Power_0(  
      UnitID:=1,  
      AxisNo:=1,  
      Enable:=TRUE,  
      bRegulatorOn:=TRUE);  
  IF PG_Power_0.Status = TRUE THEN  
    Process := 1;  
  END_IF  
  1://Execute the PG_Jog with JogForward  
  PG_Jog_0(  
    UnitID:=1,  
    AxisNo:=1,  
    JogForward:=TRUE,  
    JogBackward:=FALSE,
```

```
        Velocity:=10000,  
        AccDec:=10000);  
2://Changing the variable Process to 2 changes the jog velocity  
  PG_Jog_0(  
    UnitID:=1,  
    AxisNo:=1,  
    JogForward:=TRUE,  
    JogBackward:=FALSE,  
    Velocity:=20000,  
    AccDec:=10000);  
END_CASE
```

8.2 Operation at Over Limit Input

■ Operation at over limit input

Operations depend on the status of over limit input (+) and over limit input (-) as follows.

Condition	Direction	Limit status	Operation
When JOG operation is started	Forward	Over limit input (+): ON	Not executable, Error occurs.
		Over limit input (-): ON	Executable
	Reverse	Over limit input (+): ON	Executable
		Over limit input (-): ON	Not executable, Error occurs.
During JOG operation	Forward	Over limit input (+): ON	Stop, Error occurs.
	Reverse	Over limit input (-): ON	Stop, Error occurs.

■ Input valid logic of over limit input

- When the over limit switches (+) (-) are not connected to the pulse output unit, change the over limit input logic of the Pulse_4Axes parameter to "NO contact". The default is "NC contact", and an over limit error occurs.

■ Precautions on Over limit switch

- An over limit input valid for JOG operation, home return and pulser operation is the one logically found in the direction of the movement. Even if an over limit switch (-) is input for a movement in (+) direction or an over limit switch (+) is input for a movement in (-) direction, the operation will not stop.
- Make sure that an over limit switch (+) is set in the direction of the elapsed value increment and an over limit switch (-) in the direction of the elapsed value decrement.
- When a switch is not set in the correct direction, the followings might be a cause. Check your settings and correct them.
 - 1) An over limit switch, (+) or (-), is not set in a correct direction.
 - 2) CW / CCW output method is set reverse for the connection of the pulse output unit and the motor driver.
 - 3) A sign input logic is set reverse for the connection of the pulse output unit and the motor driver.
 - 4) Among the Pulse_4Axes parameters, the rotation direction (forward or reverse) of pulse output is reversely specified.

8.3 Precautions on Programming

■ Common precautions to each operation

- If the values for the startup speed, target speed, acceleration / deceleration, or position command value exceed the range of values which can be specified, a function block error will occur, and operation cannot be initiated.
- With the GM1 pulse output unit, specify the speed (startup speed and target speed) in the unit of "u/s". 1 u/s = 1 pps

■ Characteristics of JOG operation function

- When re-started during deceleration, the rotation will again accelerate if in the same direction.
- The target speed change during JOG operation is available only for Linear acceleration / deceleration.
- When S acceleration / deceleration is selected, the target speed changed will be ignored.
- The acceleration / deceleration cannot be changed during JOG operation.

(MEMO)

9 JOG Positioning Operation

9.1 Sample Program	9-2
9.1.1 Increment (Relative Value Control)	9-2
9.2 Operation at Over Limit Input.....	9-5
9.3 Precautions On Programming.....	9-6

9.1 Sample Program

9.1 Sample Program

9.1.1 Increment (Relative Value Control)

- JOG positioning operation is initiated using the input signal from the external switch as a trigger to perform position control.
- Use the PG_LatchPosition function block.

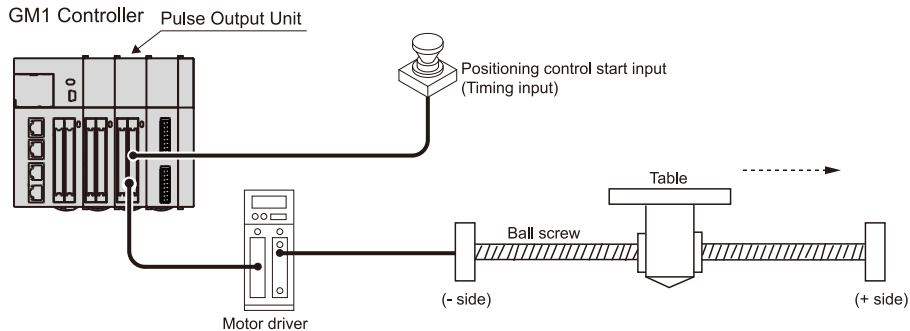

■ Pulse output diagram

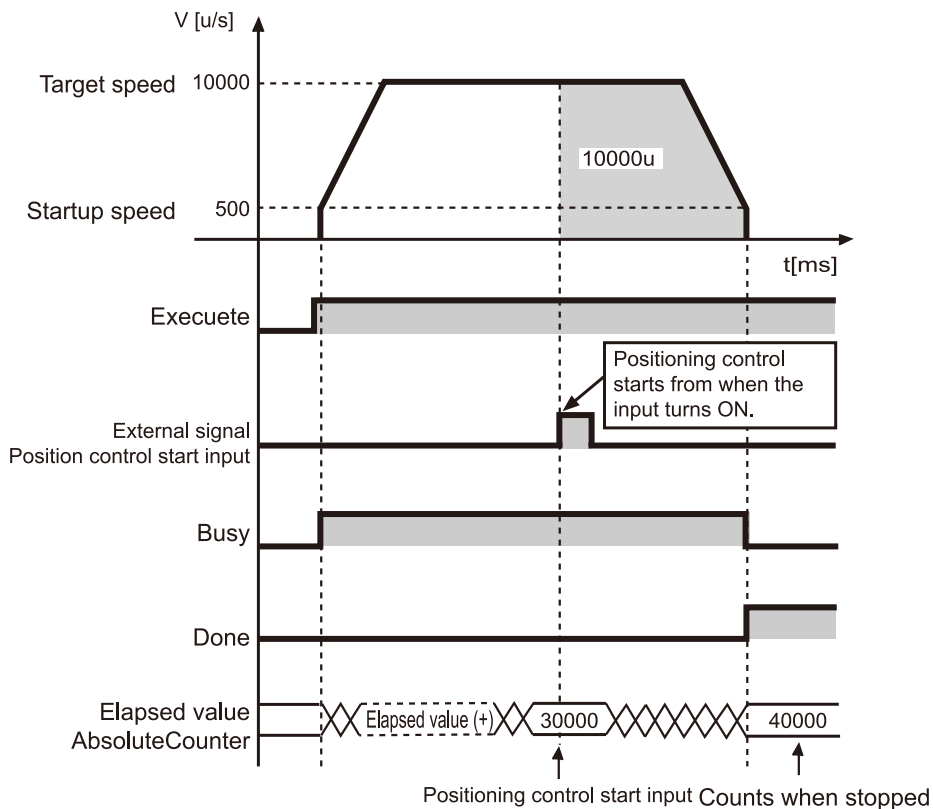

■ Parameter Settings

Parameters for the pulse output unit (Pulse_4Axes parameters)

Set from the GM Programmer. Double-click "Slot*_Pulse_4Axes (AGM1PG)" in the device pane.

Parameter	Set value	Setting range
StartupSpeed (Startup speed [u/s])	500	0 to 4294967295

PG_LatchPosition parameter

Parameter	Set value	Setting range
Target speed: Velocity [u/s]	10000	0 to 4000000
Acceleration / Deceleration: AccDec [u/s ²]	10000	1 or more ^(Note 1)
Relative distance: Distance [u]	10000	-2147483648 to 2147483647

(Note 1) Set each acceleration / deceleration time to 32767 ms or less.

■ Program (ST)

Declaration section

```
PROGRAM sample
VAR
    Process :UDINT := 0;
    PG_Power_0: PG_Power;
    PG_LatchPosition_0: PG_LatchPosition;
END_VAR
```

Implementation section

```
CASE Process OF
    0://Servo On
        PG_Power_0(
            UnitID:=1,
            AxisNo:=1,
            Enable:=TRUE,
            bRegulatorOn:=TRUE);
        IF PG_Power_0.Status = TRUE THEN
            Process := 1;
        END_IF
    1://Execute the PG_LatchPosition
        PG_LatchPosition_0(
            UnitID:=1,
            AxisNo:=1,
            Execute:=TRUE,
            Distance:= 10000,
            Velocity:=10000,
```

9.1 Sample Program

```
AccDec:=10000);  
END_CASE
```

9.2 Operation at Over Limit Input

■ Operation at over limit input

Operations depend on the status of over limit input (+) and over limit input (-) as follows.

Condition	Direction	Limit status	Operation
JOG positioning operation is started	Forward	Over limit input (+): ON	Not executable, Error occurs.
		Over limit input (-): ON	Not executable, Error occurs.
	Reverse	Over limit input (+): ON	Not executable, Error occurs.
		Over limit input (-): ON	Not executable, Error occurs.
During JOG positioning operation	Forward	Over limit input (+): ON	Stop, Error occurs.
	Reverse	Over limit input (-): ON	Stop, Error occurs.

■ Input valid logic of over limit input

- When the over limit switches (+) (-) are not connected to the pulse output unit, change the input valid logic of the over limit switch to "NO contact". The default is "NC contact", and an over limit error occurs.

9.3 Precautions On Programming

■ Common precautions to each operation

- If the values for the startup speed, target speed, acceleration / deceleration, or position command value exceed the range of values which can be specified, a function block error will occur, and operation cannot be initiated.
- With the GM1 pulse output unit, specify the speed (startup speed and target speed) in the unit of "u/s". 1 u/s = 1 pps

■ "Role of positioning control start input (Timing input)"

- When the input from "Positioning control start input (Timing input)" of the external terminal (No. A19 or B19) is turned ON, positioning control is started.
- The status of "Positioning control start input (Timing input)" can be monitored using the PG_ReadStatus function block.
- JOG positioning operation can be initiated by turning ON/OFF the PositioningStart input parameter of the PG_StopLatchPosition function block in user programs instead of the input from external terminals. It can be used when performing a debug.

■ Characteristics of JOG positioning operation function

- When JOG positioning operation is started with "Positioning control start input (Timing input)" turned ON, the positioning control is immediately started.
- When "Positioning control start input (Timing input)" is turned ON during acceleration, also the positioning control is immediately started.
- If "Positioning control start input (Timing input)" does not go ON after the JOG positioning operation is initiated, the pulses keep going out.
- The pulse output unit starts counting the number of the output pulses within 15 μ s from when "Positioning control start input (Timing input)" is ON during the JOG positioning operation. The time is always stable, enabling the table to stop at the specified position very accurately. Since each axis is completely independent, the high-accurate stop is possible even with the multiple axes.

10 Home Return

10.1 Sample Program	10-2
10.1.1 Home Return.....	10-2
10.2 Types of Home Return	10-5
10.2.1 Home Search Valid Mode	10-5
10.2.2 Home Search Invalid Mode.....	10-7
10.3 Flow of Home Return Operation	10-9
10.3.1 When the Home Input is the Z Phase of Servo Amplifier.....	10-9
10.3.2 When the Home Input is Through an External Switch	10-10
10.4 Home and Near Home Input Logic	10-11
10.4.1 When to Specify NO Contact.....	10-11
10.4.2 When to specify NC contact.....	10-11
10.5 Practical Use for Home Return	10-13
10.5.1 Using Home Input Only	10-13
10.5.2 Using One Switch for Near Home Input and Home Input	10-14
10.6 Over Limit Input.....	10-17
10.7 Precautions on Programming	10-19

10.1 Sample Program

10.1 Sample Program

10.1.1 Home Return

This section describes a program example for making a home return.

- Make a home return using the PG_Home function block
- The Input logic of near home input and home input and the home return direction are specified with the Pulse_4Axes Parameters.
- The home input is connected to the Z phase output of the motor driver, or to an external switch or a sensor.

GM1 Controller Pulse Output Unit

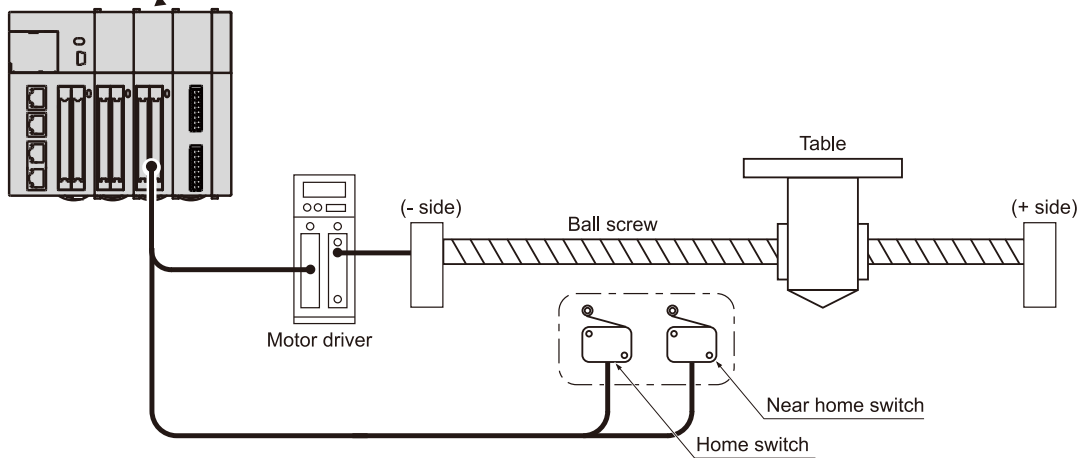

■ Pulse output diagram

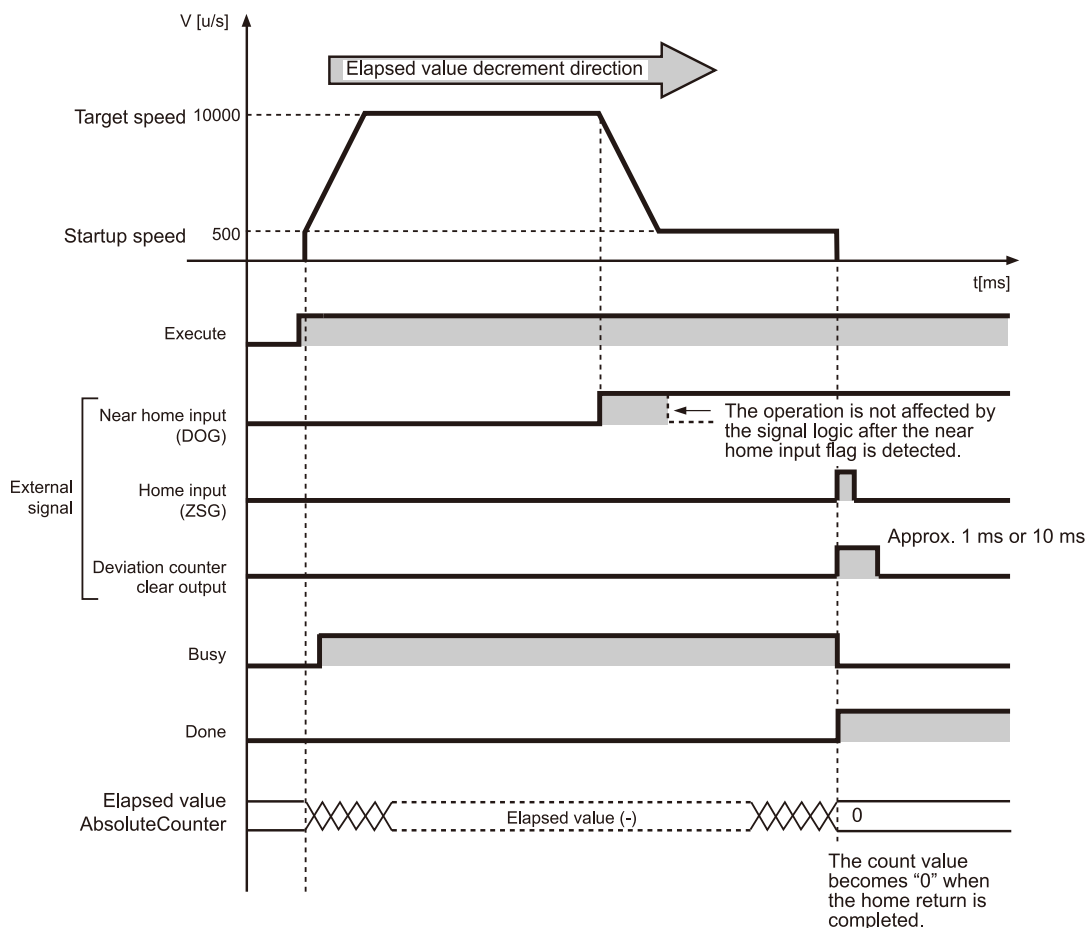

■ Parameter settings

Parameters for the pulse output unit (Pulse_4Axes parameters)

Set from the GM Programmer. Double-click "Slot*_Pulse_4Axes (AGM1PG)" in the device pane.

Parameter	Set value	Setting range
OriginReturnDirection (Home return direction)	0 : Elapsed value decrement direction	0 : Elapsed value decrement direction 1 : Elapsed value increment direction
OriginInputLogic (Home input logic)	1: NO contact	0: NC contact 1: NO contact
OriginNeighborhoodLogic (Near home logic)	0: NO contact	0: NO contact 1: NC contact
OriginSearch (Home search)	1: Enable	0: Disable 1: Enable

10.1 Sample Program

PG_Home parameter

Parameter	Set value	Setting range
Maximum speed: Velocity [u/s]	10000	0 ~ 4000000 ^(Note 1)
Acceleration / deceleration: AccDec [u/s ²]	10000	1 or more ^(Note 2)
Start-up speed: StartUpVelocity (u/s) ^(Note 3)	500	0 ~ 4294967295

(Note 1) Set maximum speed 1 u/s or more. If set to zero, an error occurs at execution.

(Note 2) Set each acceleration / deceleration time to 32767 ms or less.

(Note 3) For homing, the start-up speed is specified by the function block argument.

■ Program (ST)

Declaration section

```
PROGRAM sample
VAR
    Process : UDINT := 0;
    PG_Power_0 : PG_Power;
    PG_Home_0 : PG_Home;
END_VAR
```

Implementation section

```
CASE Process OF
    0://Servo On
        PG_Power_0(
            UnitID:=1,
            AxisNo:=1,
            Enable:=TRUE,
            bRegulatorOn:=TRUE);
        IF PG_Power_0.Status = TRUE THEN
            Process := 1;
        END_IF
    1://Execute the PG_Home
        PG_Home_0(
            UnitID:=1,
            AxisNo:=1,
            Execute:=TRUE,
            Velocity:=10000,
            StartUpVelocity:=500,
            AccDec:=10000);
END_CASE
```

10.2 Types of Home Return

10.2.1 Home Search Valid Mode

■ What is Home search valid mode?

- When the home position is in between where the table travels or when the direction of the home return could be in the both directions, the home return in the both directions can be performed using the over limit switch (+) or over limit switch (-). Setting the parameter home search enables a home search.
- When the near home input is made during acceleration, the table automatically reverses the direction to check ON near home input and then OFF near home input. Then, the home return operation is automatically executed.

■ When Near home input exists in the direction of home return

→ The table slows down near the near home and stops at the home input position.

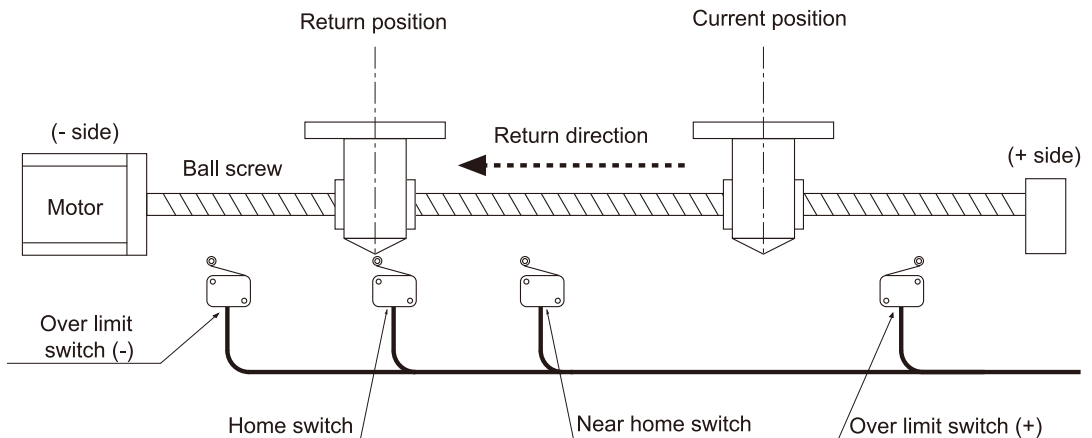

■ When Near home input does not exist in the direction of home return

(1) Home return operation starts in the direction specified in the program. The table travels to the position where the over limit switch (-) is made.

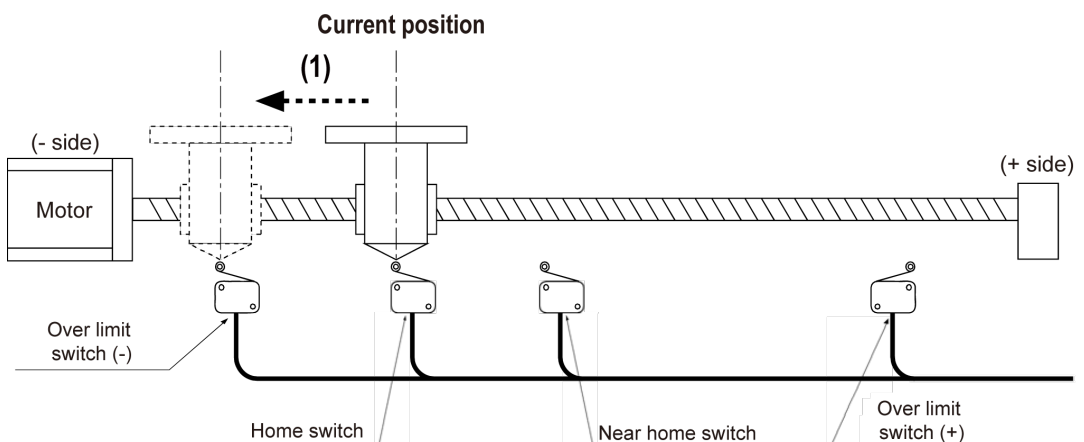

10.2 Types of Home Return

(2) When the over limit switch (-) is detected, the table reverses the direction. When the near home input is once turned ON and the OFF, the table slows down and turns around.

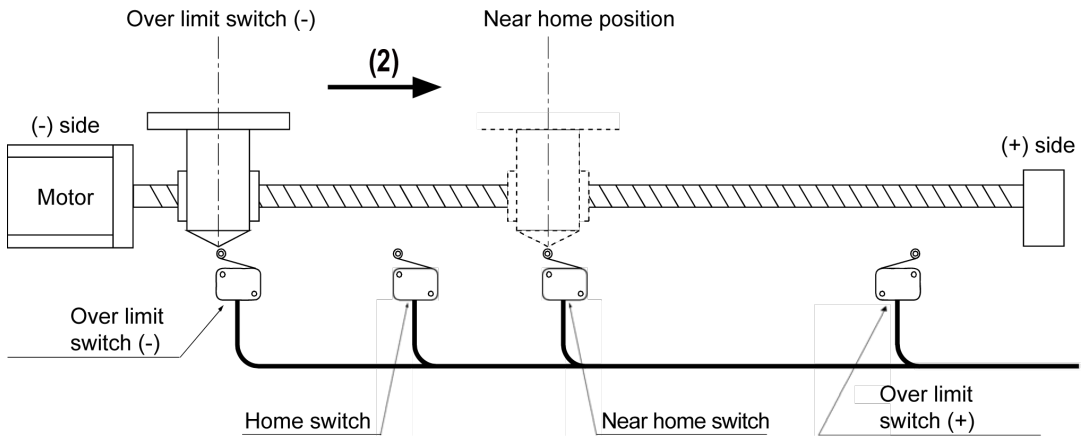

(3) When the near home is detected again, the speed slows down from the target speed to the startup speed and the table stops at the home position.

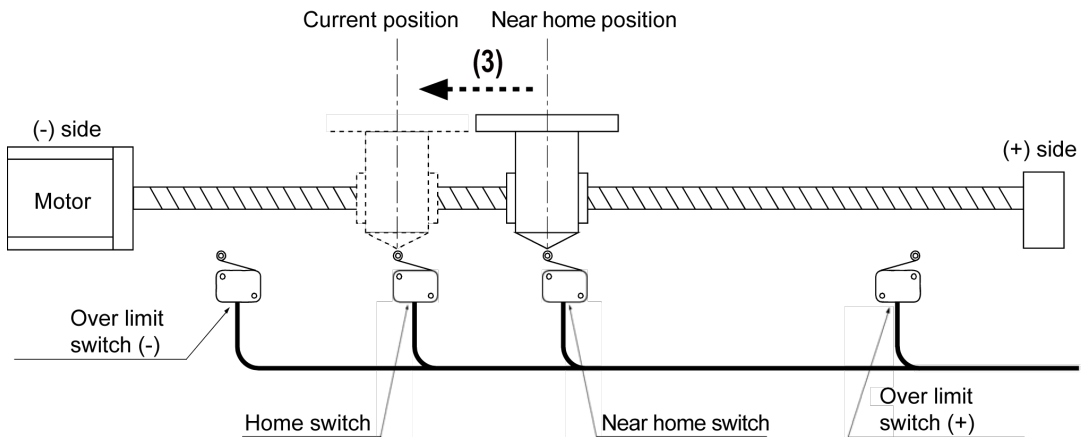

■ When Near home input is ON during home return

(1) Home return operation starts in the opposite direction of the one specified in the program. When the near home return input changes from ON to OFF, the table reverses its direction.

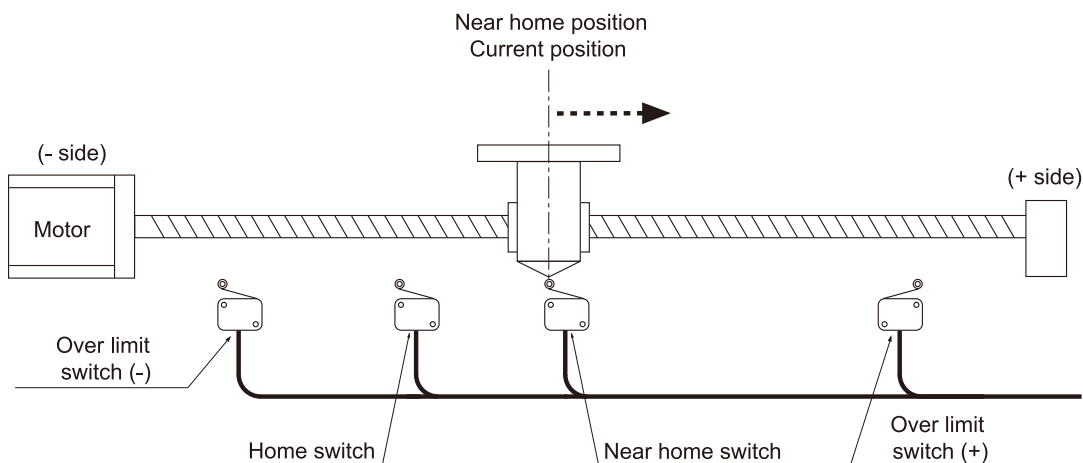

(2) When the near home is detected again, the speed slows down from the target speed to the startup speed and the table stops at the home position.

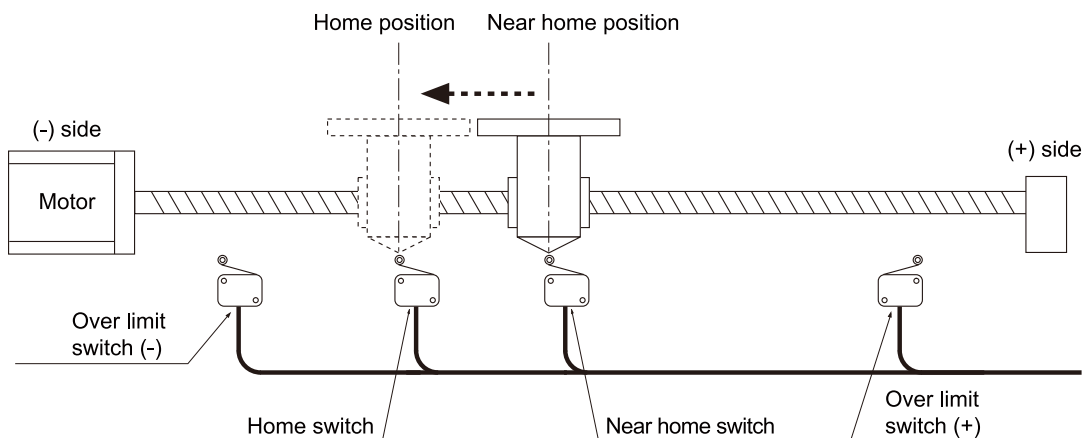

Note

- The above operation is also applicable when the speed does not reach the target one before the table comes to the near home position.
- In the home search operation, the deceleration stop operation starts when the limit is input. Therefore, the pulses are output only for the acceleration / deceleration time that was specified in advance in the home return operation. (Not for the instant stop).
Change the acceleration / deceleration to adjust the time before stopping the pulses and outputting the reverse pulse after the limit signal input.

10.2.2 Home Search Invalid Mode

■ What is Home search invalid mode?

- The table does not reverse the direction but stops by detecting the over limit switch (+) or (-). Setting the parameter home search disables a home search.

10.2 Types of Home Return

■ When Near home input exists in the direction of home return

→ The table slows down near the near home and stops at the home input position.

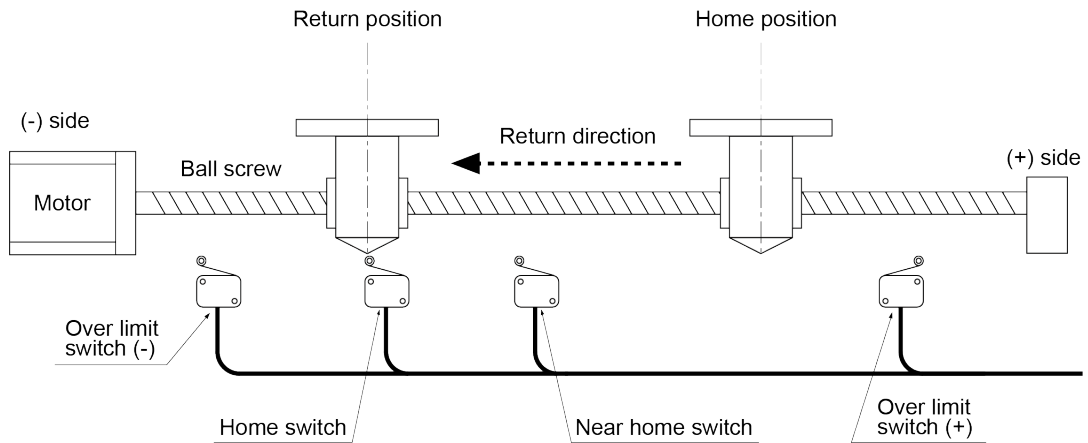

■ When Near home input does not exist in the direction of home return

Home return operation starts in the direction specified in the program, and the operation stops when the over limit switch (-) is detected.

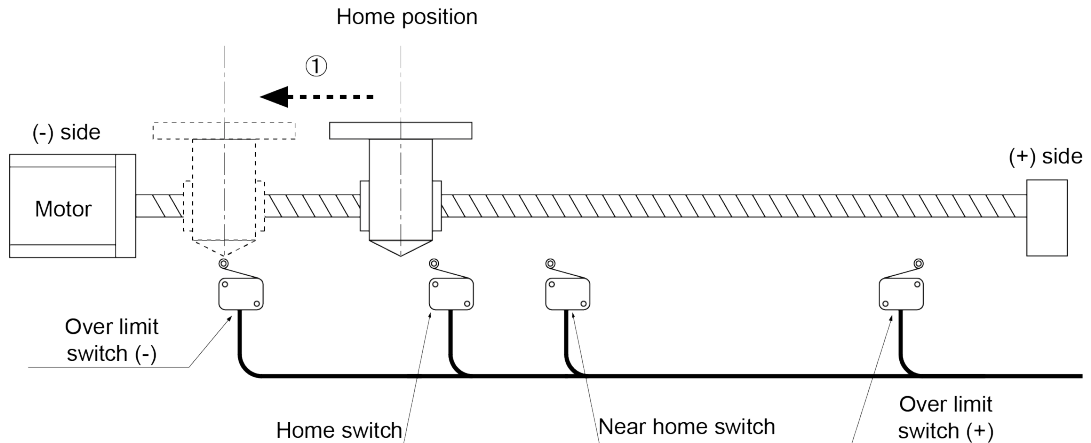

i Info.

- If the home switch is ON when the home return is started, home return is immediately completed.

10.3 Flow of Home Return Operation

10.3.1 When the Home Input is the Z Phase of Servo Amplifier

When near home input is input, the speed slows.

When the startup speed has been reached after deceleration, the pulse output unit recognizes the first input Z phase signal as the home input signal, and stops.

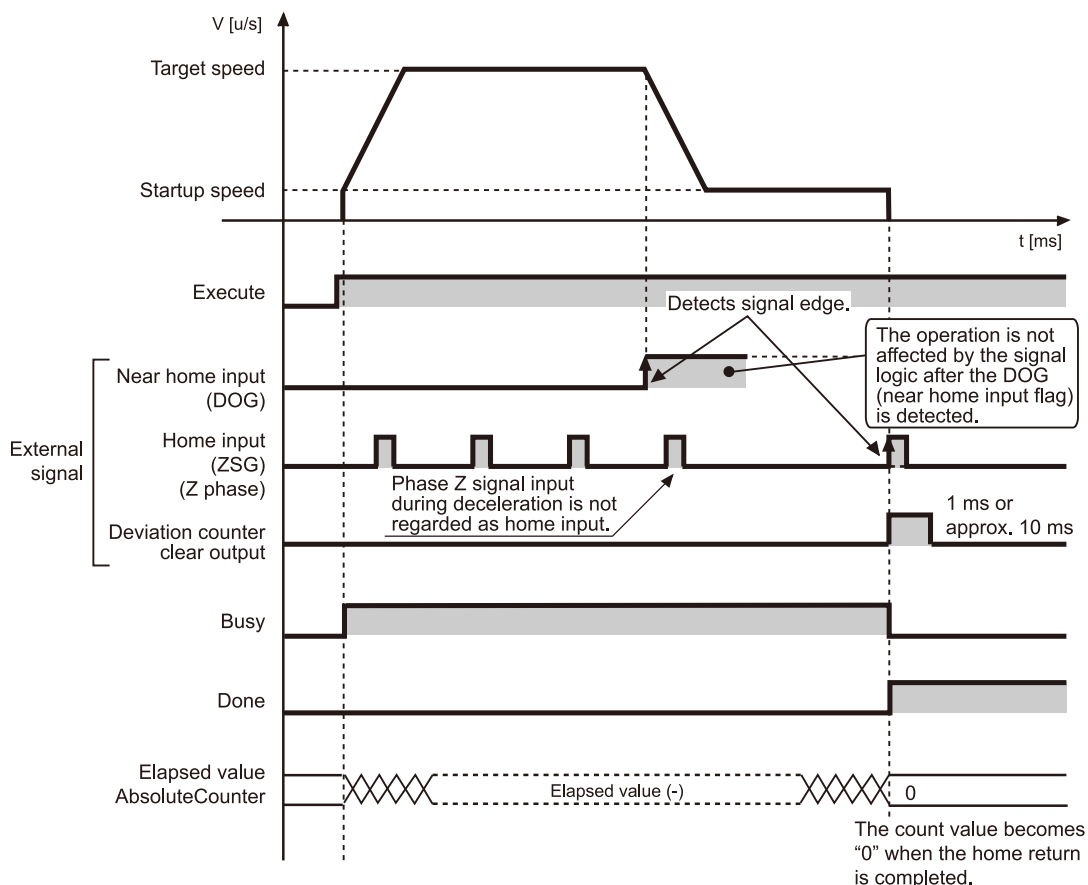

i Info.

- Z phase signals input during deceleration are not viewed as home input signals. Deceleration continues without stopping until the startup speed is reached. Then the motor continues to rotate at the startup speed until a Z phase signal is input.
- When the home return is completed, the elapsed value stored in the unit is cleared and at the same time, the deviation counter clear output signal is output. The output time of the deviation counter clear output signal can be changed using "Pulse_4Axes Parameters". Select either 1 ms or 10 ms.
- When the home return is started at a position where both the near home input and the home input are valid, the operation will be as follows;
 - When Home search is valid: Starts home search operation.
 - When Home search is invalid: Does not operate.

10.3 Flow of Home Return Operation

10.3.2 When the Home Input is Through an External Switch

When near home input is input, the speed slows. When the home input signal is input after the startup speed has been reached by deceleration, operation stops.

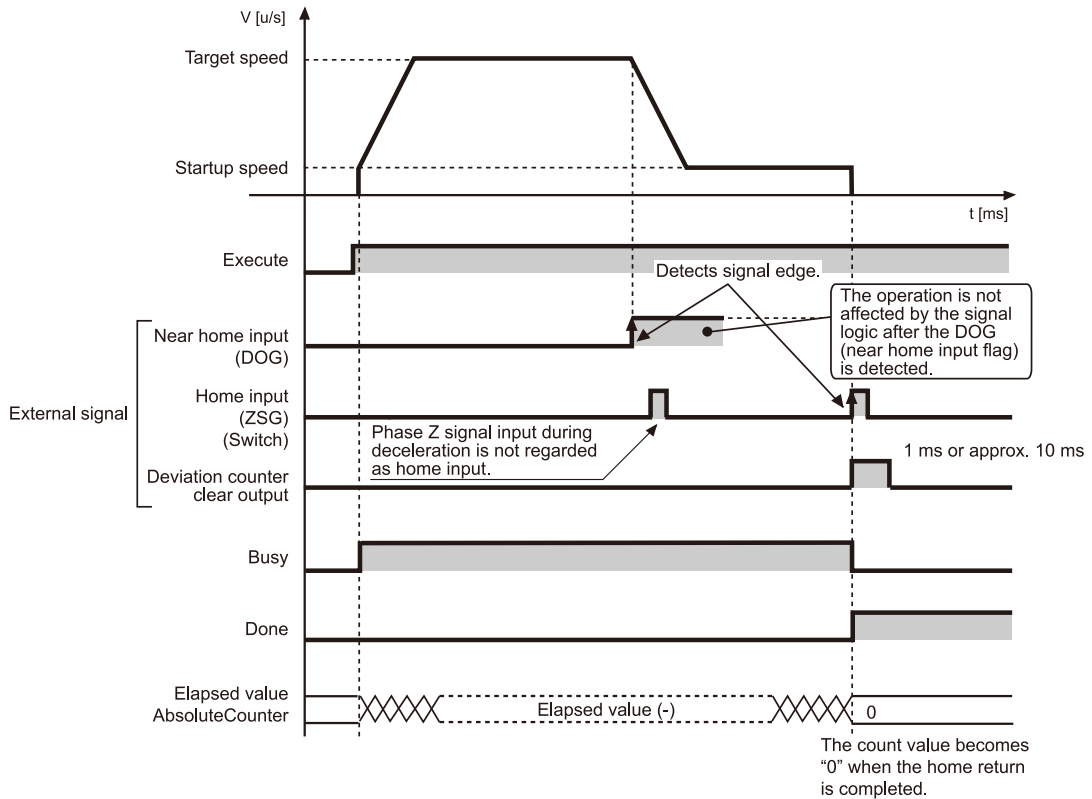

i Info.

- Home input signals input during deceleration are not viewed as home input signals. Deceleration continues without stopping until the startup speed is reached. Then the motor continues to rotate at the startup speed until a home input signal is input.
- When the home return is completed, the elapsed value stored in the unit is cleared and at the same time, the deviation counter clear output signal is output. The deviation counter clear output signal can be changed using "Pulse_4Axes Parameters". Select either 1 ms or 10 ms.
- When the home return is started at a position where both the near home input and the home input are valid, the operation will be as follows;
 - When Home search is valid: Starts home search operation.
 - When Home search is invalid: Does not operate.

10.4 Home and Near Home Input Logic

10.4.1 When to Specify NO Contact

In cases like that below where power is supplied to the input circuit of the unit, select “NO contact” for the parameter home input logic or the near home logic.

■ When to specify NO contact

1. If the input switch contact is the NO contact.
2. If the input sensor goes ON when the home or near home position is detected.
3. When the Z phase of the driver is connected.

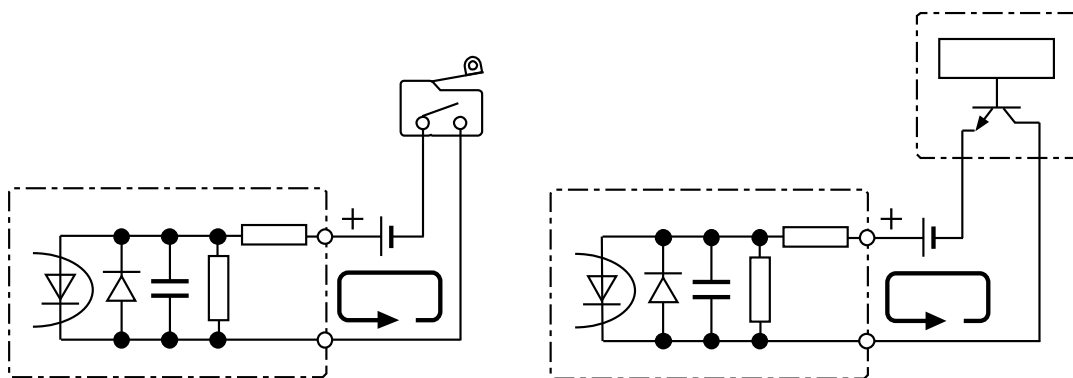

Current flows when the home or near home position is detected.

10.4.2 When to specify NC contact

In cases like that below where power is supplied to the input circuit of the unit, select “NC contact” for the parameter home input logic or the near home logic.

■ When to specify NC contact

1. If the input switch contact is the NC contact.
2. If the input sensor goes OFF when the home or near home position is detected.

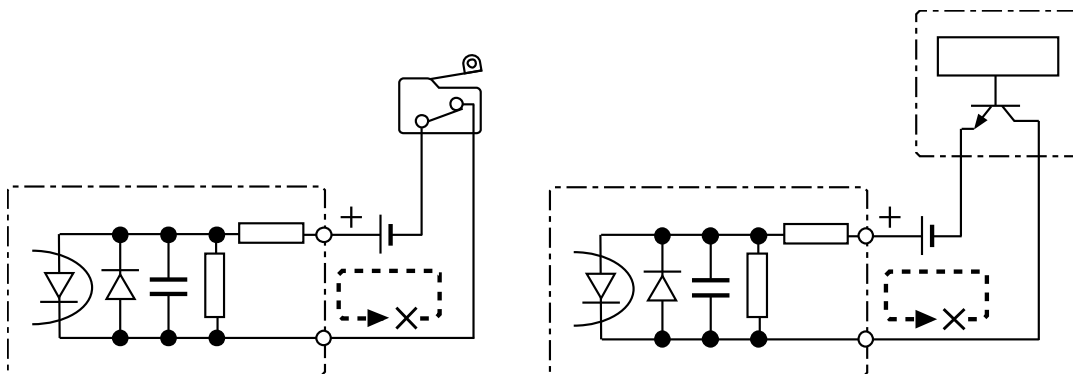

10.4 Home and Near Home Input Logic

Current stops when the home or near home position is detected.

10.5 Practical Use for Home Return

10.5.1 Using Home Input Only

■ Connection

The home input switch is connected. No near home input switch is connected.

GM1 Controller Pulse Output Unit

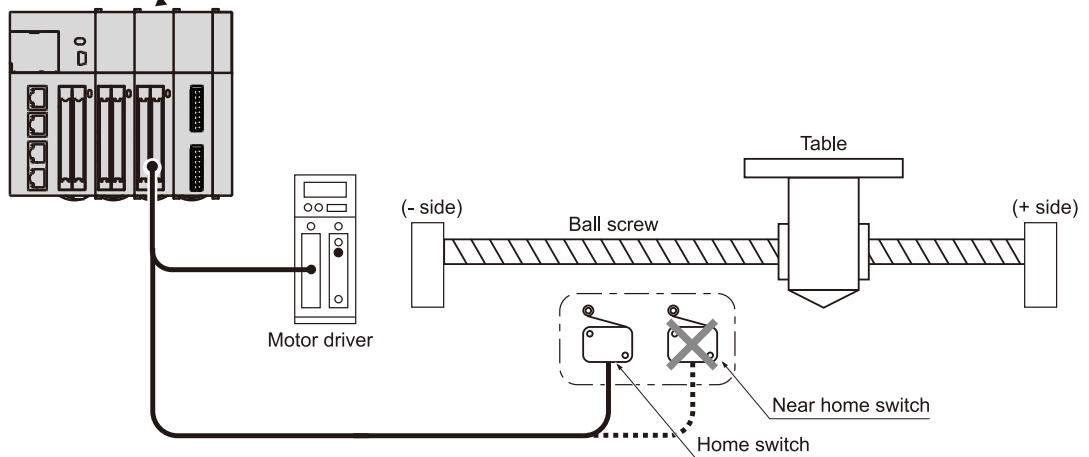

■ Input logic settings

Set parameters to satisfy the following conditions.

- Home input logic: NO contact
- Near home Input logic: NC contact

■ Operation

- When home return is started, the motor rotates in the direction of home return.
- The motor rotates at the startup speed. At this time, the near home input is already ON due to the input logic setting.
- The motor stops when the home input turns ON and becomes valid.

10.5 Practical Use for Home Return

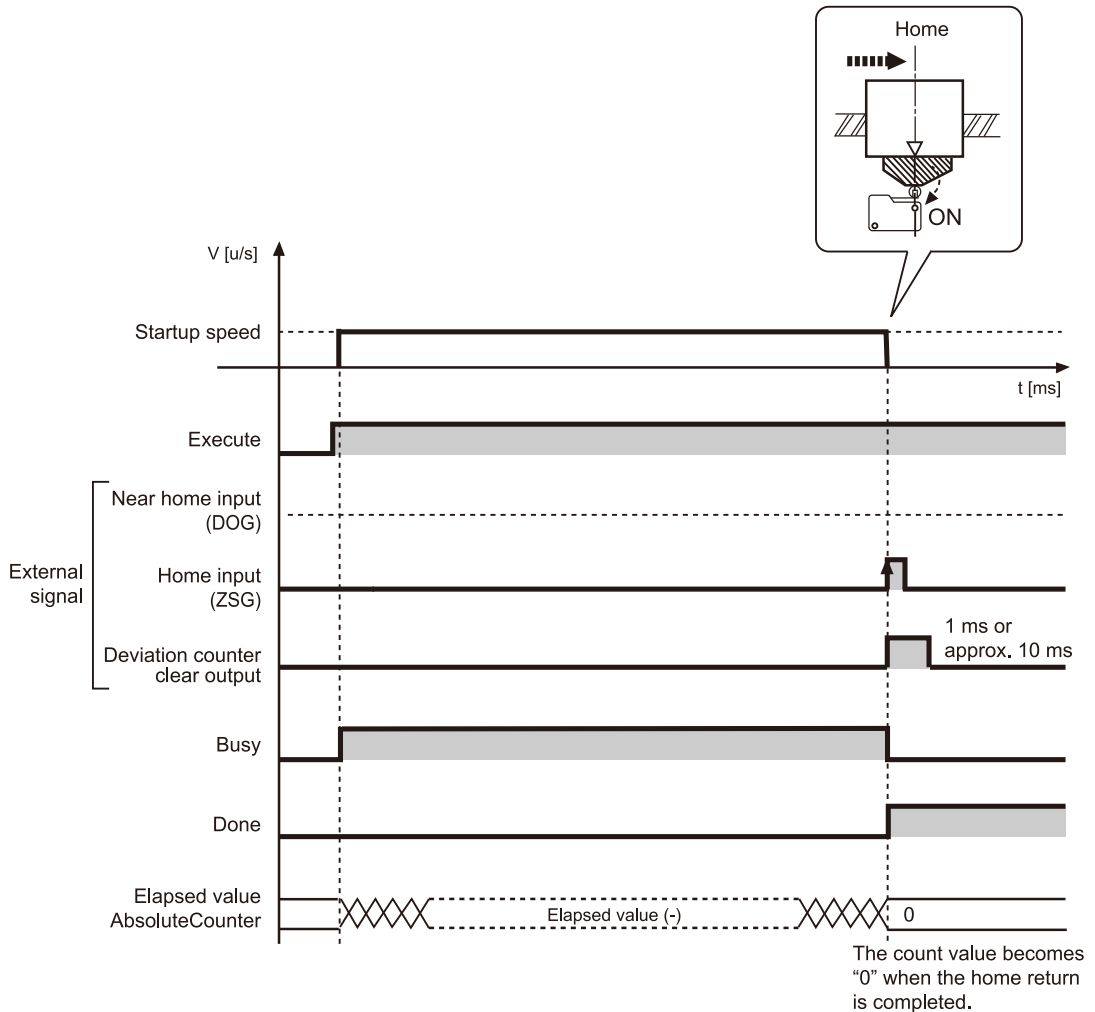

- Execute home return at the startup speed.
- When the home input is connected to the Z phase output of the motor driver, one switch cannot be used as the home input.
- The above example is only applicable in the home search invalid mode.

10.5.2 Using One Switch for Near Home Input and Home Input

■ Applicable environment

Applicable to a system in which the near home input switch is once turned ON and then OFF when the home return is started.

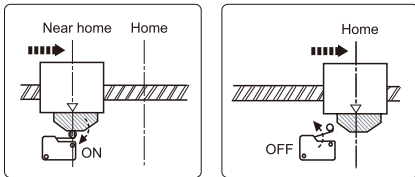

■ Connection

Connect near home input and home input to the near home input switch.

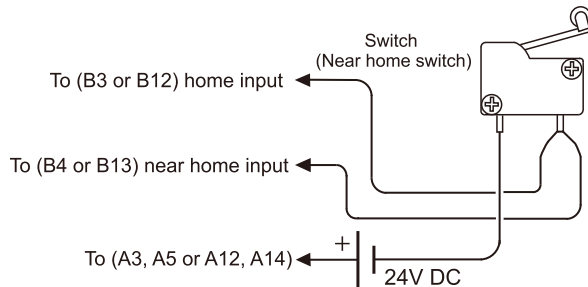

■ Input logic setting (when using an NO contact)

Set parameters to satisfy the following conditions.

- Home input logic: NO contact
- Near home input logic: NC contact

■ Operation

- When home return is started, the motor rotates in the direction of home return.
- When the near home input switch is turned ON, the speed slows down to the startup speed. The motor rotates further and the near home input will be OFF.
- At this point, the home input should already be ON, as a result of the input logic, and the motor stops.

10.5 Practical Use for Home Return

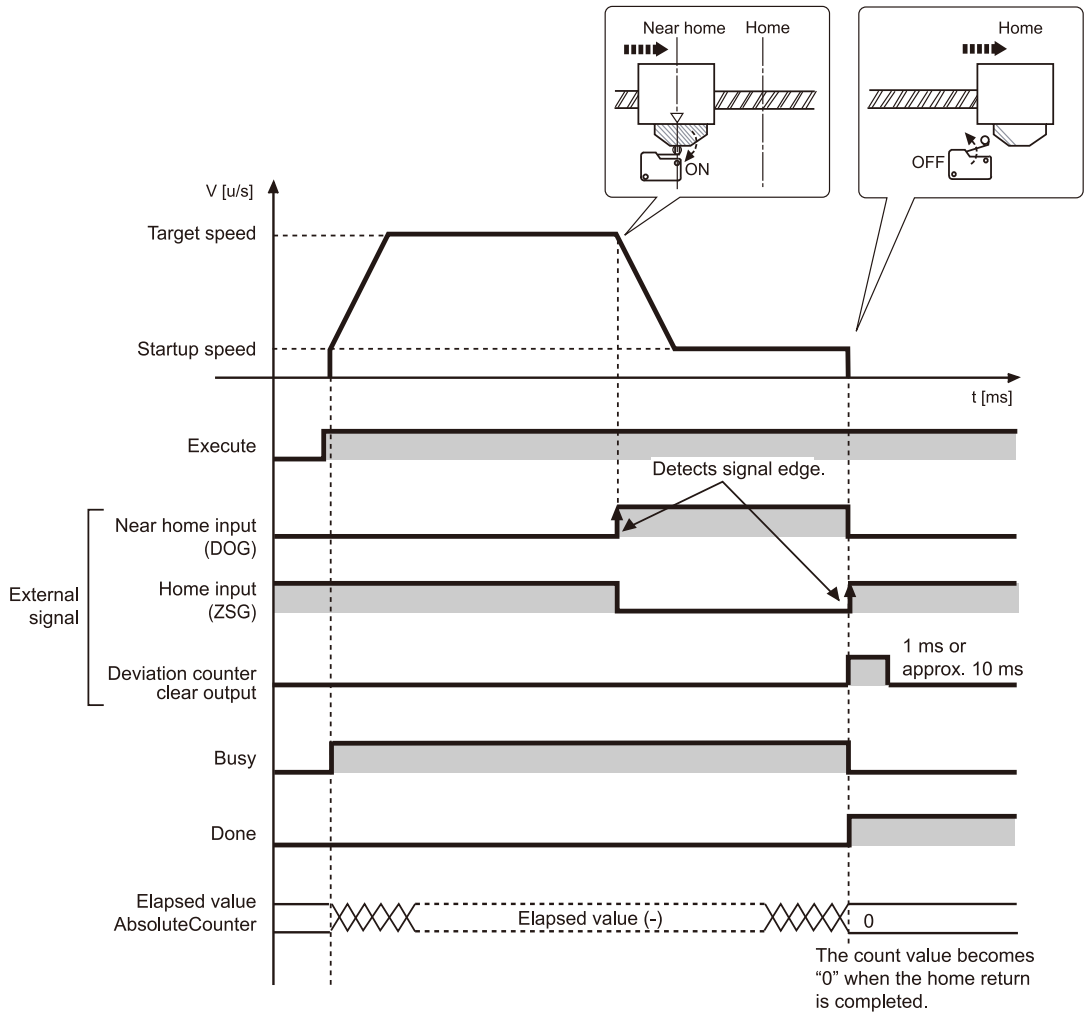

- 
 The near home input should be ON for the time more than the deceleration time. The operation of the near home input will not be affected by the signal logic change after the near home input is detected.

10.6 Over Limit Input

Operations depend on the status of over limit input (+) and over limit input (-) as follows.

■ Operation at over limit input (Home search is valid)

Condition	Direction	Limit status	Operation
When home return operation is executed	Forward	Over limit input (+): ON	Executable
		Over limit input (-): ON	Executable
	Reverse	Over limit input (+): ON	Executable
		Over limit input (-): ON	Executable
During home return operation	Forward	Over limit input (+): ON	Automatic reverse operation
	Reverse	Over limit input (-): ON	Automatic reverse operation

■ Operation at over limit input (Home search is invalid)

Condition	Direction	Limit status	Operation
When home return operation is executed	Forward	Over limit input (+): ON	Not executable, Error occurs.
		Over limit input (-): ON	Executable
	Reverse	Over limit input (+): ON	Executable
		Over limit input (-): ON	Not executable, Error occurs.
During home return operation	Forward	Over limit input (+): ON	Stop, Error occurs.
	Reverse	Over limit input (-): ON	Stop, Error occurs.

■ Input valid logic of over limit input

- When the over limit switches (+) (-) are not connected to the pulse output unit, change the over limit input valid logic of the Pulse_4Axes parameter to "NO contact". The default is "NC contact", and an over limit error occurs.

■ Precautions on over limit switch

- An over limit input valid for JOG operation, home return and pulser operation is the one logically found in the direction of the movement. Even if an over limit switch (-) is input for a movement in (+) direction or an over limit switch (+) is input for a movement in (-) direction, the operation will not stop.
- Make sure that an over limit switch (+) is set in the direction of the elapsed value increment and an over limit switch (-) in the direction of the elapsed value decrement.
- When a switch is not set in the correct direction, the followings might be a cause. Check your settings and correct them.
 - 1) An over limit switch, (+) or (-), is not set in a correct direction.
 - 2) CW / CCW output method is set reverse for the connection of the pulse output unit and the motor driver.
 - 3) A sign input logic is set reverse for the connection of the pulse output unit and the motor driver.

10.6 Over Limit Input

4) Among the Pulse_4Axes parameters, the rotation direction (forward or reverse) of pulse output is reversely specified.

10.7 Precautions on Programming

■ Common precautions to each operation

- If the values for the startup speed, target speed, acceleration / deceleration, or position command value exceed the range of values which can be specified, a function block error will occur, and operation cannot be initiated.
- With the GM1 pulse output unit, specify the speed (startup speed and target speed) in the unit of "u/s". 1 u/s = 1 pps

■ Precautions on programming (Home return)

- For homing, the start-up speed uses the function block argument, not the parameter setting.
- Set the startup speed to 1 u/s or more. The value set for the startup speed will be the setting for the creep speed.
- The Pulse_4Axes parameter settings vary depending on the logic of the connected near home input or home input.

■ Characteristics of home return function

- The pulse output unit stops the pulse output within 1 μ s from when the home input is ON. The processing time is always stable, enabling the highly accurate home return. Since each axis is completely independent, the home returns by the multiple axes at the same time are possible.

(MEMO)

11 Pulser Input Operation

11.1 Sample Program	11-2
11.1.1 Pulser Input Operation	11-2
11.2 Operation at Over Limit Input	11-5
11.3 Precautions on Programming.....	11-6
11.4 Types of Manual Pulse Generators that Can be Used.....	11-7

11.1 Sample Program

11.1 Sample Program

11.1.1 Pulsar Input Operation

This section describes a program example for pulsar input operation.

- Pulses are output according to the input from the pulsar. Use the PG_Pulsar function block.
- The input mode, pulse input transfer multiple and pulse output transfer multiple are specified using the Pulse_4Axes Parameters.

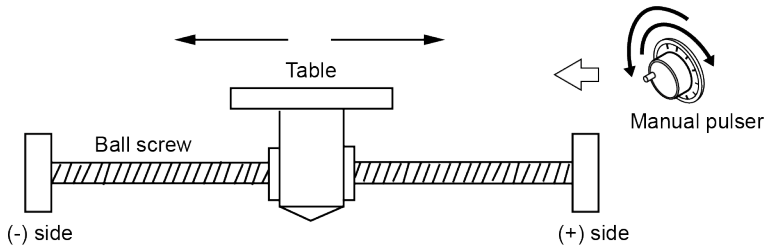

■ Pulse output diagram

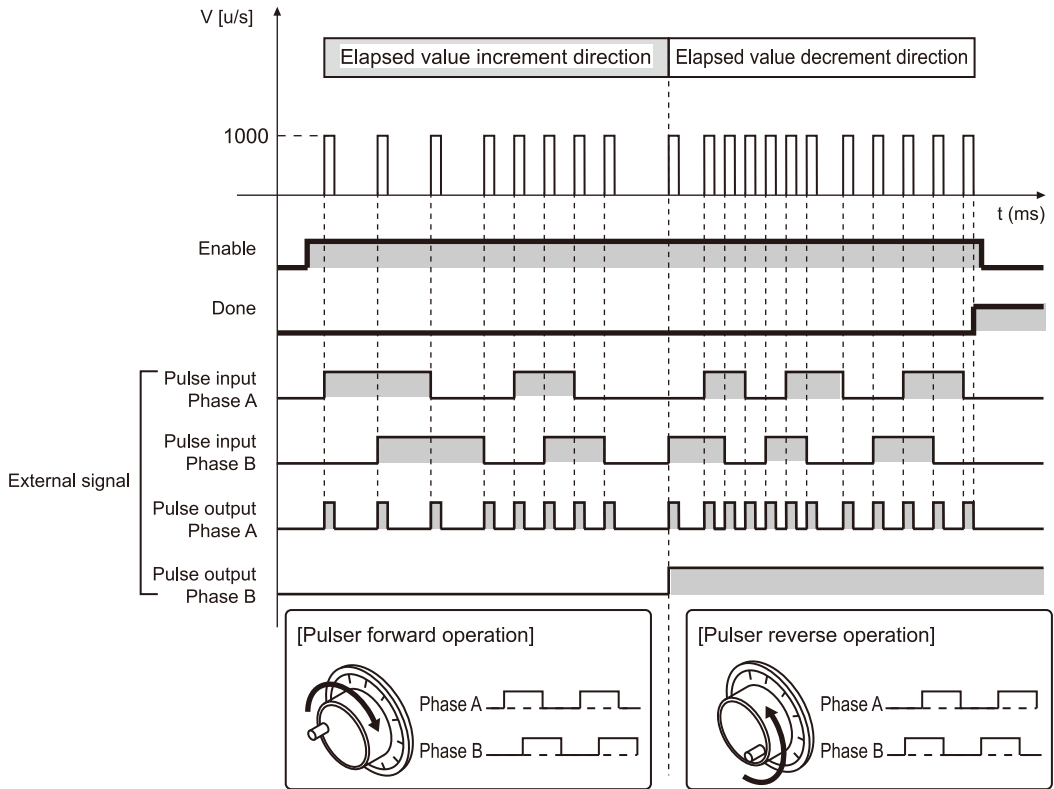

■ Parameter Settings

Parameters for the pulse output unit (Pulse_4Axes parameters)

Set from the GM Programmer. Double-click "Slot*_Pulse_4Axes (AGM1PG)" in the device pane.

Parameter	Set value	Setting range
PulseInputMode (Pulse input mode)	0: 2-phase input	0: 2-phase input 1: Direction distinction input 2: Individual input
PulseInputCountMultiplication (Pulse input transfer multiple)	2: x4	0: x1 1: x2 2: x4
PulseInOutMultiplication (Pulser input, pulse output transfer multiple)	0: x1	0: x1 1: x2 2: x5 3: x10 4: x50 5: x100 6: x500 7: x1000
PulseOutputMode (Pulse output mode)	0: Pulse / Sign	0: Pulse / Sign 1: CW / CCW

PG_Pulser parameter

Parameter	Set value	Setting range
Target speed: Velocity [u/s]	10000	0 to 4000000

■ Program (ST)

Declaration section

```
PG_Power;
PG_Pulser_0: PG_Pulser;
END_VAR
```

Implementation section

```
CASE Process OF
  0://Servo On
    PG_Power_0(
      UnitID:=1,
      AxisNo:=1,
      Enable:=TRUE,
      bRegulatorOn:=TRUE);
    IF PG_Power_0.Status = TRUE THEN
      Process := 1;
    END_IF
  1://Execute the PG_Pulser
    PG_Pulser_0(
```

11.1 Sample Program

```
UnitID:=1,  
AxisNo:=1,  
Enable:=TRUE,  
Velocity:=10000,  
Ratio:=PG_PULSER_RATIO.RATIO_x1);
```

```
END_CASE
```

11.2 Operation at Over Limit Input

■ Operation at over limit input

Operations depend on the status of over limit input (+) and over limit input (-) as follows.

Condition	Direction	Limit status	Operation
When pulser input operation is executed	Forward	Over limit input (+): ON	Not executable, Error occurs.
		Over limit input (-): ON	Executable
	Reverse	Over limit input (+): ON	Executable (Note 1)
		Over limit input (-): ON	Not executable, Error occurs.
During pulser input operation	Forward	Over limit input (+): ON	Stop, Error occurs.
	Reverse	Over limit input (-): ON	Stop, Error occurs.

(Note 1) The Pulse/Sign output mode can be executed. An over limit error occurs when the CW or CCW output mode has been set.

■ Input valid logic of over limit input

- When the over limit switches (+) (-) are not connected to the pulse output unit, change the over limit input valid logic of the Pulse_4Axes parameter to "NO contact". The default is "NC contact", and an over limit error occurs.

■ Precautions on over limit switch

- An over limit input valid for JOG operation, home return and pulser operation is the one logically found in the direction of the movement. Even if an over limit switch (-) is input for a movement in (+) direction or an over limit switch (+) is input for a movement in (-) direction, the operation will not stop.
- Make sure that an over limit switch (+) is set in the direction of the elapsed value increment and an over limit switch (-) in the direction of the elapsed value decrement.
- When a switch is not set in the correct direction, the followings might be a cause. Check your settings and correct them.
 - 1) An over limit switch, (+) or (-), is not set in a correct direction.
 - 2) CW / CCW output method is set reverse for the connection of the pulse output unit and the motor driver.
 - 3) A sign input logic is set reverse for the connection of the pulse output unit and the motor driver.
 - 4) Among the Pulse_4Axes parameters, the rotation direction (forward or reverse) of pulse output is reversely specified.

11.3 Precautions on Programming

■ Common precautions to each operation

- If the values for the startup speed, target speed, acceleration / deceleration, or position command value exceed the range of values which can be specified, a function block error will occur, and operation cannot be initiated.
- With the GM1 pulse output unit, specify the speed (startup speed and target speed) in the unit of "u/s". 1 u/s = 1 pps

■ Precautions on programming (Pulser input operation function)

- When counting the 2-phase input such as the input from the encoder, specify the parameter to set the pulse input transfer multiple to "4 multiple setting" (x 4) or "2 multiple setting" (x 2) to prevent counting error.
- Set the target speed to a moderately large value according to the pulse output transfer multiple during pulser input operation. If the pulse output transfer multiple is large and the target speed is small, the command for the next pulser input may be executed before completing the pulse output for the specified number of pulses, and the output for the number of input pulses may not be obtained.
- Do not execute PG_Pulser for using the feedback counter function.

11.4 Types of Manual Pulse Generators that Can be Used

- **A pulse generators should be used for which the number of output pulses is "25P/R" (25 pulses per cycle).**

With the "100P/R" (100 pulses per cycle) type, four pulses are output per click, and operation may not be accurate in some cases.

- **A line driver output type is recommended.**

A transistor open collector output type or transistor output type with pull-up resistance may be used.

- **Recommended manual pulsers**

Manufacturer	Model	Remarks
Tokyo Sokuteikizai Co.,Ltd.	RE45BA2D5C	Black with no TOSOKU logo mark
Nemicon Corporation	UFO-0025-2D	Black with no logo mark

- **Please visit the following site for inquiries about the manual pulsers.**

Tokyo Sokuteikizai Co.,Ltd. <http://www.tosoku-inc.co.jp>

Nemicon Corporation <https://www.nemicon.co.jp/nemicon/>

(MEMO)

12 Deceleration Stop and Forced Stop

12.1 Sample Program	12-2
12.1.1 Deceleration Stop	12-2
12.1.2 Forced Stop	12-4
12.1.3 Resuming Operation After Stop	12-5
12.2 Precautions on Stop Operations	12-8

12.1 Sample Program

12.1 Sample Program

Use the PG_Stop function block. Either the deceleration stop or emergency stop can be selected using the StopMethod input.

12.1.1 Deceleration Stop

This section describes a program example for making a deceleration stop using the PG_Stop function block while the PG_MoveRelative function block is being executed.

- When the PG_Stop function block is executed with the StopMethod input parameter set to FALSE while the motor is in operation, deceleration stop operation starts. The pulse output is stopped when the speed is decelerated to the startup speed.

This operation is common to E-point control, P-point control, home Return, JOG operation and JOG positioning operation.

- For pulser input operation, pulse output stops.
- For each function block that is being operated, the "CommandAborted" flag is set to TRUE, causing the function block to terminate.

■ Pulse output diagram

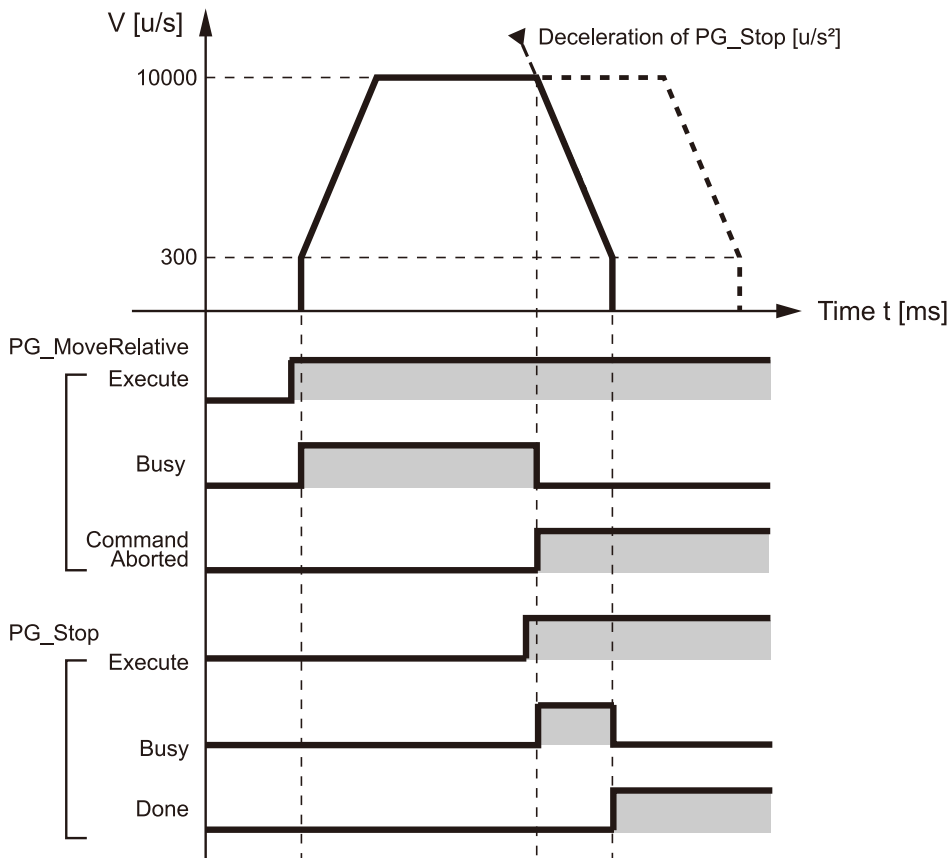

■ Parameter settings

PG_Stop parameter

Parameter	Set value	Setting range
StopMethod	FALSE	TRUE: Forced stop FALSE: Deceleration stop

■ Program (ST)

Declaration section

```
PROGRAM sample
VAR
  Process :UDINT := 0;
  PG_Power_0: PG_Power;
  PG_MoveRelative_0: PG_MoveRelative;
  PG_Stop_0: PG_Stop;
  Stop: BOOL;
END_VAR
```

Implementation section

```
CASE Process OF
  0://Servo On
    PG_Power_0(
      UnitID:=1,
      AxisNo:=1,
      Enable:=TRUE,
      bRegulatorOn:=TRUE);
    IF PG_Power_0.Status = TRUE THEN
      Process := 1;
    END_IF
  1://Execute the PG_MoveRelative
    PG_MoveRelative_0(
      UnitID:=1,
      AxisNo:=1,
      Execute:=TRUE,
      Distance:= 10000,
      Velocity:=10000,
      AccDec:=10000);
    //Changing the variable Stop to TRUE execute the PG_Stop.
    //CommandAborted of PG_MoveRelative becomes TRUE and processing is interrupted.
    IF Stop = TRUE THEN
      PG_Stop_0(
        UnitID:=1,
        AxisNo:=1,
        Execute:=TRUE,
        StopMethod:=FALSE); //Decelerate and stop
    END_IF
END_CASE
```

12.1 Sample Program

12.1.2 Forced Stop

This section describes a program example for making a forced stop using the PG_Stop function block while the PG_MoveRelative function block is being executed.

- When the PG_Stop function block is executed with the StopMethod input parameter set to TRUE while the motor is in operation, a forced stop is performed
- This operation is common to E-point control, P-point control, home return, JOG operation, JOG positioning operation and pulser input operation.
- For each function block that is being operated, CommandAborted is set to TRUE and the function block is interrupted.

■ Pulse output diagram: Forced stop

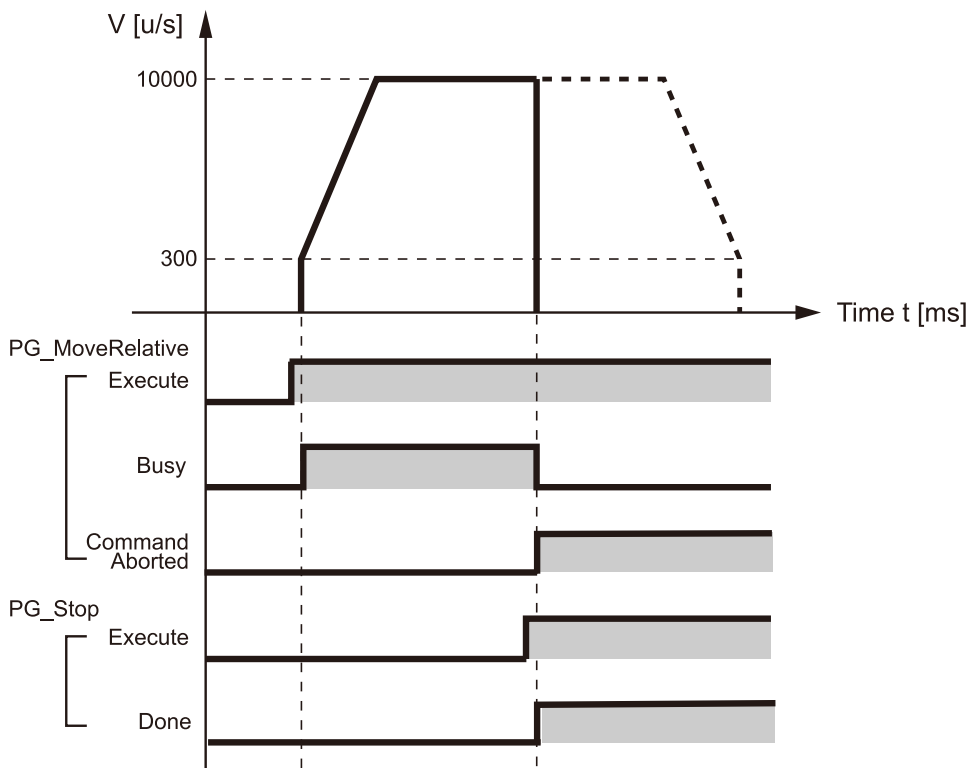

■ Parameter Settings

PG_Stop parameter

Parameter	Set value	Setting range
StopMethod	TRUE	TRUE: Forced stop FALSE: Deceleration stop

■ Program (ST)

Declaration section

```
PROGRAM sample
VAR
  Process :UDINT := 0;
  PG_Power_0: PG_Power;
  PG_MoveRelative_0: PG_MoveRelative;
  PG_Stop_0: PG_Stop;
  Stop: BOOL;
END_VAR
```

Implementation section

```
CASE Process OF
  0://Servo On
    PG_Power_0(
      UnitID:=1,
      AxisNo:=1,
      Enable:=TRUE,
      bRegulatorOn:=TRUE);
    IF PG_Power_0.Status = TRUE THEN
      Process := 1;
    END_IF
  1://Execute the PG_MoveRelative
    PG_MoveRelative_0(
      UnitID:=1,
      AxisNo:=1,
      Execute:=TRUE,
      Distance:= 10000,
      Velocity:=10000,
      AccDec:=10000);
    //Changing the variable Stop to TRUE execute the PG_Stop.
    //CommandAborted of PG_MoveRelative becomes TRUE and processing is i
nterrupted.
    IF Stop = TRUE THEN
      PG_Stop_0(
        UnitID:=1,
        AxisNo:=1,
        Execute:=TRUE,
        StopMethod:=TRUE); //Forced stop
    END_IF
END_CASE
```

12.1.3 Resuming Operation After Stop

This section describes a program example for executing the PG_MoveRelative function block, making a stop using the PG_Stop function block, and then resuming the the PG_MoveRelative function block.

12.1 Sample Program

■ Pulse output diagram

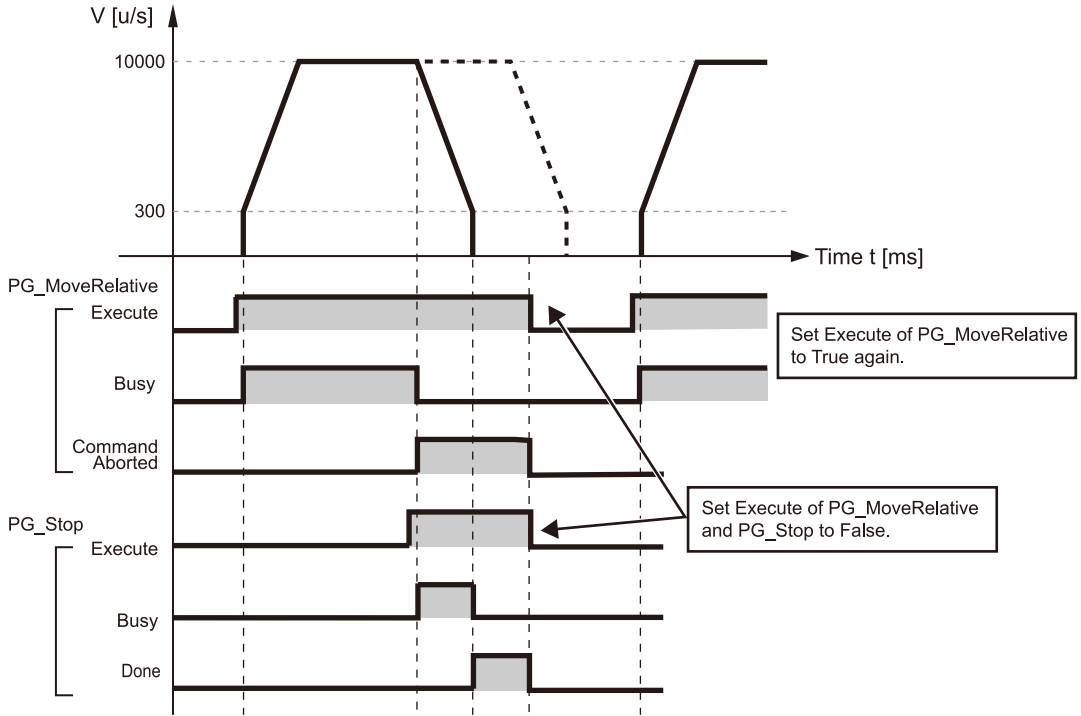

■ Program (ST)

Declaration section

```
PROGRAM sample
VAR
    Process :UDINT := 0;
    PG_Power_0: PG_Power;
    PG_MoveRelative_0: PG_MoveRelative;
    PG_Stop_0: PG_Stop;
    Stop: BOOL;
END_VAR
```

Implementation section

```
CASE Process OF
    0://Servo On
        PG_Power_0(
            UnitID:=1,
            AxisNo:=1,
            Enable:=TRUE,
            bRegulatorOn:=TRUE);
        IF PG_Power_0.Status = TRUE THEN
            Process := 1;
        END_IF
    1://Execute the PG_MoveRelative
        PG_MoveRelative_0(
```

```
UnitID:=1,  
AxisNo:=1,  
Execute:=TRUE,  
Distance:= 10000,  
Velocity:=10000,  
AccDec:=10000);  
//Changing the variable Stop to TRUE execute the PG_Stop.  
//CommandAborted of PG_MoveRelative becomes TRUE and processing is i  
nterrupted.  
IF Stop = TRUE THEN  
  PG_Stop_0(  
    UnitID:=1,  
    AxisNo:=1,  
    Execute:=TRUE,  
    StopMethod:=FALSE);    //Decelerate and stop  
END_IF  
IF PG_Stop_0.Done = TRUE THEN  
  PG_Stop_0(  
    UnitID:=1,  
    AxisNo:=1,  
    Execute:=FALSE);  
  PG_MoveRelative_0(  
    UnitID:=1,  
    AxisNo:=1,  
    Execute:=FALSE);  
  Process := 2;  
END_IF  
2://Execute the PG_MoveRelative  
PG_MoveRelative_0(  
  UnitID:=1,  
  AxisNo:=1,  
  Execute:=TRUE,  
  Distance:= 10000,  
  Velocity:=10000,  
  AccDec:=10000);  
END_CASE
```

12.2 Precautions on Stop Operations

■ Elapsed value data after forced stop

- Elapsed value data in the unit is held even after a forced stop is applied.
- Under normal conditions, it is possible that a mechanical error has occurred, so after home return, we recommend that positioning control be started again.

13 Feedback Counter

13.1 Sample Program	13-2
13.1.1 Step Out Detection by Comparing Feedback Value with Elapsed Value	13-2
13.2 Feedback Counter Function.....	13-4
13.2.1 Feedback Counter Function.....	13-4
13.2.2 Operation of Feedback Counter.....	13-4
13.2.3 Feedback Counter Settings	13-4
13.2.4 Input Method of Feedback Counter	13-5

13.1 Sample Program

13.1 Sample Program

13.1.1 Step Out Detection by Comparing Feedback Value with Elapsed Value

This section describes a program example for comparing the count of the output pulses with the count of the feedback pulses during the E-point control and for making a deceleration stop if the count is out of the allowable range.

- Using the PG_ReadStatus function block, read the pulse output elapsed value and the pulse count of the feedback counter.
 - Pulse output elapsed value (AbsoluteCounter output parameter)
 - Pulse count of the feedback counter (FeedbackCounter output)
- In the following program, a deceleration stop is performed when the following state is reached.
"Pulse output elapsed value"—"Pulse count of the feedback counter" > 1000 (u)

■ Program (ST)

Declaration section

```
PROGRAM sample
VAR
  Process :UDINT := 0;
  PG_Power_0: PG_Power;
  PG_MoveRelative_0: PG_MoveRelative;
  PG_Stop_0: PG_Stop;
  PG_ReadStatus_0: PG_ReadStatus;
END_VAR
```

Implementation section

```
CASE Process OF
  0://Servo On
    PG_Power_0(
      UnitID:=1,
      AxisNo:=1,
      Enable:=TRUE,
      bRegulatorOn:=TRUE);
    IF PG_Power_0.Status = TRUE THEN
      Process := 1;
    END_IF
  1://Execute the PG_MoveRelative
    PG_MoveRelative_0(
      UnitID:=1,
      AxisNo:=1,
      Execute:=TRUE,
      Distance:= 10000,
      Velocity:=10000,
      AccDec:=10000);
    PG_ReadStatus_0(
      UnitID:=1,
      AxisNo:=1,
      Enable:=TRUE);
    IF PG_ReadStatus_0.AbsoluteCounter - PG_ReadStatus_0.FeedbackCounter
```

```
> 1000 THEN
    Process := 2;
END_IF
2://Execute the PG_Stop
  PG_Stop_0(
    UnitID:=1,
    AxisNo:=1,
    Execute:=TRUE,
    StopMethod:=FALSE);    //Decelerate and stop
END_CASE
```

13.2 Feedback Counter Function

13.2 Feedback Counter Function

13.2.1 Feedback Counter Function

■ Overview of feedback counter function

- The pulse output unit has a function to count pulse signals from an external input such as encoder at high speed. This function is applied for step out detection by comparing feedback values with elapsed values.
- The elapsed value and feedback counter value can be read for each axis using the PG_ReadStatus function block.
- The elapsed value and feedback counter value can be written for each axis using the PG_SetPosition function block. Writing should be done while the axis operation is stopped.

■ Usage restrictions on feedback counter function

The input terminals (terminal numbers A8, B8, A9, B9, A17, B17, A18, B18) are common to the feedback counter and pulser input.

They cannot be used for the same axis in combination with pulser input operation.

13.2.2 Operation of Feedback Counter

- When the power supply is turned OFF, the counter value is reset to zero (0).
- When home return is completed or an error is cleared (PG_ClearError function block), the counter value is reset to zero (0).
- If the count value exceeds the maximum (or minimum) value, it returns to the minimum (maximum) value. The pulse output does not stop if this occurs, and no error occurs.

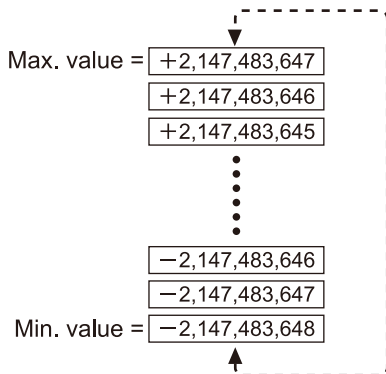

13.2.3 Feedback Counter Settings

- Settings of the feedback counter can be changed using the "PG_SetPosition" function block.
- When counting the 2-phase input such as the input from the encoder, set the pulse input transfer multiple to "4 multiple setting" (x 4) or "2 multiple setting" (x 2) using the Pulse_4Axes parameters to prevent counting error.

13.2.4 Input Method of Feedback Counter

- Select from the following three types according to input devices to be connected.
- The count operation varies depending on the settings of multiplication factor as shown below.

■ **Count method**

Method	Connection	Count
2-phase (Phase difference)		<p>For the 2-phase input, the input A signal and input B signal of each counter are connected to the phase A and phase B of an encoder.</p> <p>The count direction depends on the phase difference between phases A and B. When the phase A is preceding by 90 degrees in electrical angle than the phase B, the count value is incremented. When the phase A is delayed by 90 degrees in electrical angle than the phase B, the count value is decremented.</p>
Individual		<p>In the individual input method, the counter is incremented when the input A signal rises or falls, and decremented when the input B signal rises or falls.</p>
Direction discrimination		<p>For the direction detection input, the count signal is connected to the input A signal. The count direction is controlled by the level of the direction signal of input B signal.</p> <p>When the input B signal is on, the counter is incremented when the input A signal rises or falls. When the input B signal is ON, the counter is decremented.</p>

■ **Count operation of 2-phase input (Phase difference input)**

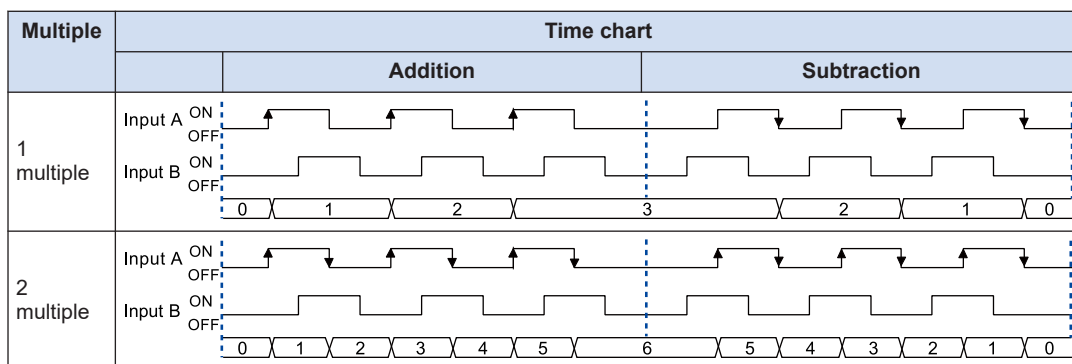

13.2 Feedback Counter Function

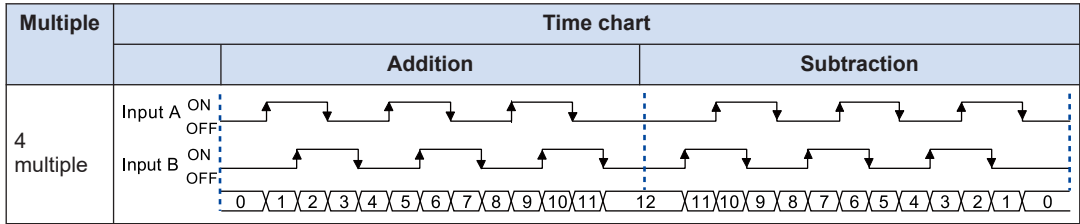

Count operation of individual input

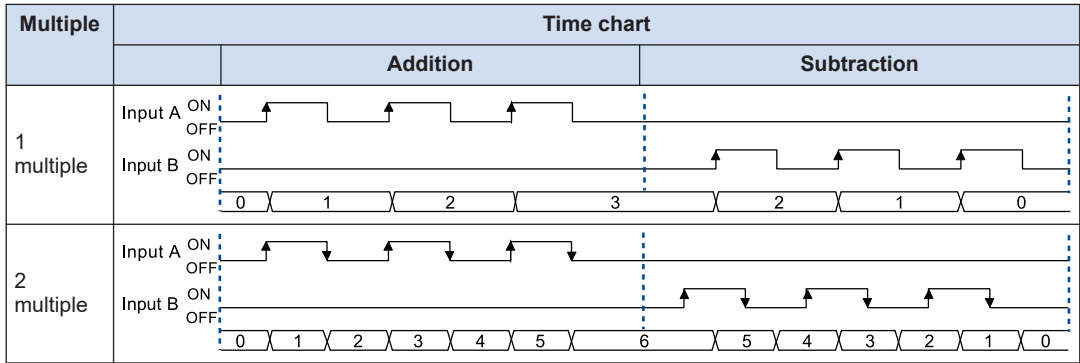

Count operation of direction discrimination input

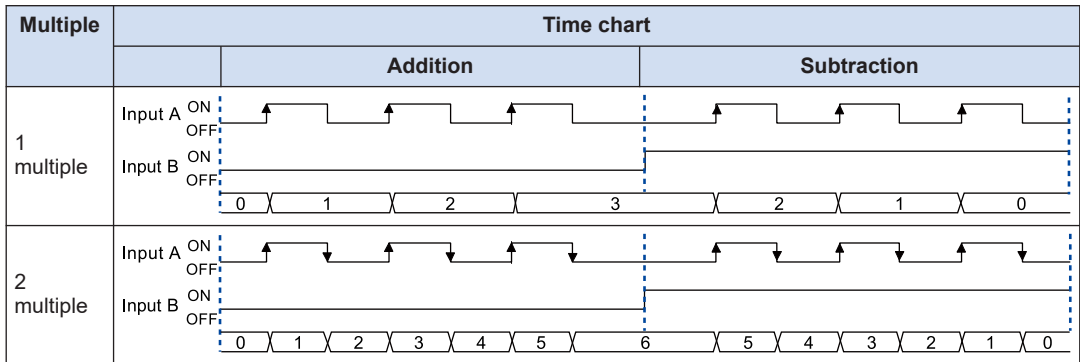

14 Precautions Concerning Unit Operation and Programs

14.1	Precautions Relating to Basic Operations of the Unit	14-2
14.1.1	Operation When the Controller Switches from RUN to STOP Mode	14-2
14.1.2	Restrictions after Starting Operation	14-2

14.1 Precautions Relating to Basic Operations of the Unit

14.1 Precautions Relating to Basic Operations of the Unit

14.1.1 Operation When the Controller Switches from RUN to STOP Mode

- If the Controller switches to "STOP" during the following operation, any pulse output unit operations in progress at that point are interrupted for safety reasons, and the speed decelerates.
 - E-point control
 - P-point control
 - JOG operation
 - JOG positioning operation
 - Home return
- When the operation is resumed, the function block that is being operated outputs TRUE for CommandAborted and the control is interrupted. Execute the control using the timing when Execute becomes TRUE as a trigger.
- The pulse output is stopped during the pulser input operation.

Example

If the Controller switches from the RUN to the STOP mode during E-point control operation

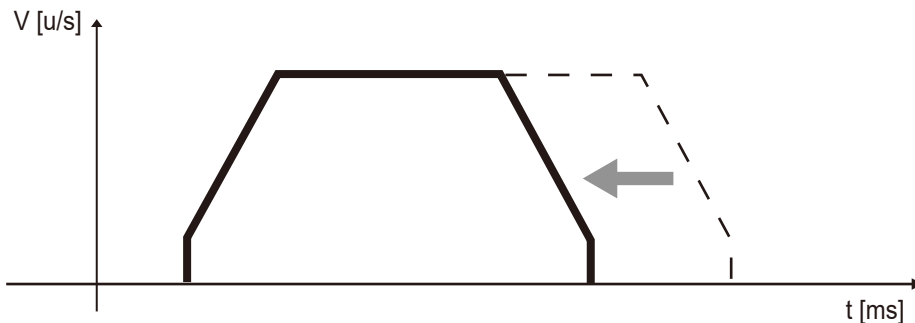

i Info.

- At the point at which the Controller switches from the RUN to the STOP mode, deceleration stop operation starts. The acceleration rate used for deceleration follows the deceleration rate of the function block being executed.
- The Controller mode should not be switched from RUN to STOP while positioning operation is being executed under normal usage conditions.

14.1.2 Restrictions after Starting Operation

- While any one of the six basic operations of the pulse output unit (E-point control, P-point control, home return, JOG operation, JOG positioning operation and pulser input operation) is being executed, it is not possible to switch to another operation even if a function block is executed.
- For the function block that is executed later, CommandAborted is set to TRUE and processing is interrupted.

Info.

- If the PG_Stop function block (deceleration stop or forced stop) is executed, any one of the six basic operations noted above (E-point control, P-point control, home return, JOG operation, JOG positioning operation and pulser input operation) stops immediately.

(MEMO)

15 Troubleshooting

15.1 Pulse Output Unit Operation If an Error Occurs.....	15-2
15.1.1 If the Pulse Output Unit ERROR LED Lights	15-2
15.1.2 If the Controller ERROR LED Lights	15-2
15.2 Errors Which Occur in Pulse Output Unit.....	15-3
15.3 What to Do If an Error Occurs.....	15-4
15.3.1 If the Pulse Output Unit ERROR LED Lights	15-4
15.3.2 What to Do When a Limit Error Occurs.....	15-4
15.3.3 If the Motor Does Not Turn (if the LED for pulse output A or B is flashing or lit).....	15-4
15.3.4 If the Motor Does Not Turn (if the LED for pulse output A or B is not lit)	15-5
15.3.5 Rotation/Movement Direction is Reversed.....	15-5
15.3.6 The Stopping Position is OFF for a Home Return	15-6
15.3.7 Speed Does Not Slow Down for a Home Return	15-7
15.3.8 Movement Does Not Stop at Home Position (after decelerating for home return)	15-8

15.1 Pulse Output Unit Operation If an Error Occurs

15.1 Pulse Output Unit Operation If an Error Occurs

15.1.1 If the Pulse Output Unit ERROR LED Lights

■ When starting (stopped)

- If a limit error occurs when the pulse output unit is started (stopped), various operations will not begin.
- This applies to E-point control, P-point control, home return, JOG operation, JOG positioning operation and pulser input operation, none of which will be initiated.

■ During operation

- If a limit error occurs, the pulse output unit interrupts any operation currently in progress, and starts the stop operation.

Info.

- When a limit error occurs, operation cannot be restarted until the error is cleared by executing the PG_ClearError function block.
- Operation continues on other axes where the error has not occurred.

15.1.2 If the Controller ERROR LED Lights

The pulse output unit interrupts any operation currently in progress, and enters the "deceleration stop" status.

15.2 Errors Which Occur in Pulse Output Unit

- Errors related to the pulse output unit can be checked using the Error/ErrorId output parameter of each function block.
For details, refer to *GM1 Series Reference Manual (Instruction Edition)*.
- When a limit input becomes enabled, the pulse output unit warns the user of a limit error.

■ Cases in which a limit error occurs, and their contents

Operation pattern		At startup		During operation	
		Over limit input (+)	Over limit input (-)	Over limit input (+)	Over limit input (-)
E-point control	Forward	Error	Error	Error	Error
	Reverse	Error	Error	Error	Error
P-point control	Forward	Error	Error	Error	Error
	Reverse	Error	Error	Error	Error
Home return (Home search is disabled.)	Forward	Error	(Note 1)	Error	(Note 1)
	Reverse	(Note 1)	Error	(Note 1)	Error
Home return (Home search is enabled.)	Forward	When the home position cannot be searched, an error will be detected. (Note 2)			
	Reverse				
JOG operation	Forward	Error	(Note 1)	Error	(Note 1)
	Reverse	(Note 1)	Error	(Note 1)	Error
JOG positioning operation	Forward	Error	Error	Error	Error
	Reverse	Error	Error	Error	Error
Pulser input operation	Forward	Error	(Note 1)	Error	(Note 1)
	Reverse	(Note 3)	Error	(Note 1)	Error
Operation when above error occurs		Operation does not begin.		Stop	

(Note 1) Data of this area is not subject to errors.

(Note 2) If the near home input does not go ON when the over limit input in the opposite goes ON after the table travel direction is automatically reversed by the over limit switch while the home search is enabled, a limit error occurs.

(Note 3) If the pulser input operation is started when the over limit input (+) goes ON, the Pulse / Sign output mode can be initiated. An over limit error occurs when the CW or CCW output mode has been set.

15.3 What to Do If an Error Occurs

15.3.1 If the Pulse Output Unit ERROR LED Lights

■ **Situation**

An over limit error occurs.

■ **Solution**

Check the ErrorId output of the function block.

15.3.2 What to Do When a Limit Error Occurs

■ **Procedure 1**

Using the PG_ReadStatus function block, check if the over limit switch is ON.

■ **Procedure 2 (When the over limit input is ON)**

In case of error with the set over limit switch being OFF or without the over limit switch, change the limit input logic using the parameter.

■ **Procedure 2 (When the over limit input is OFF)**

When the set over limit switch is ON, clear the error status using the PG_ClearError function block.

■ **Procedure 3 (When the over limit input is OFF)**

Execute either JOG operation or home return to move the table until the over limit switch goes OFF.

— **REFERENCE** —

[4.3 List of Pulse_4Axes Parameters](#)

15.3.3 If the Motor Does Not Turn (if the LED for pulse output A or B is flashing or lit)

■ **Solution 1 (For the servo amplifier)**

Using the PG_Power function block, check to make sure the servo on state is entered

■ **Solution 2**

Check to make sure the power supply for the driver is ON.

■ Solution 3

- Check to make sure the wiring between the pulse output unit and the driver has been correctly connected.
- Check to make sure the 24 V DC voltage is supplied to the external power supply terminals (terminal numbers A20 and B20).

■ Solution 4

Check to make sure the settings for the pulse output method (CW / CCW method or Pulse / Sign method) are appropriate for the driver.

15.3.4 If the Motor Does Not Turn (if the LED for pulse output A or B is not lit)

■ Solution

Review the program.

i Info.

- Check the following items.
 - Check the input logic of the over limit switch. In this case, the error LED is lit.

15.3.5 Rotation/Movement Direction is Reversed

■ Situation

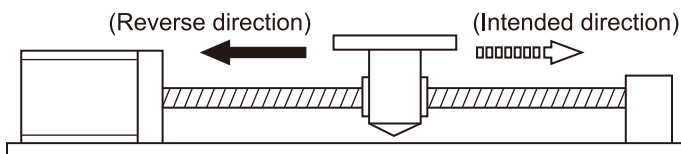

■ Solution 1

- Make sure the wiring between the pulse output unit and the driver has been correctly connected.
- Make sure the CW / CCW output or the Pulse / Sign output has been connected to the pertinent input on the driver side.

■ Solution 2

- Make sure the command position of the function block is correctly specified.
- Specify the Pulse / Sign output and CW / CCW output using the GM Programmer.

■ Solution 3

If the settings for the position command data have been designed with the plus (+) and minus (-) directions reversed, change the direction of rotation using the parameter.

15.3 What to Do If an Error Occurs

REFERENCE

4.3 List of Pulse_4Axes Parameters

15.3.6 The Stopping Position is OFF for a Home Return

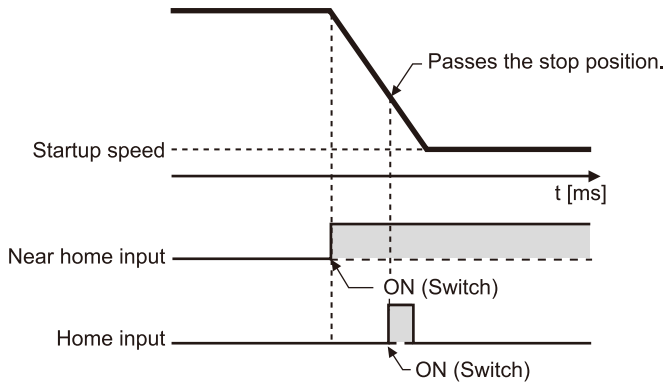

■ Situation

When a home return is carried out, there is a possibility that the speed cannot be slowed sufficiently. If deceleration cannot be continued down to the startup speed, the unit will not stop even if there is home input.

■ Solution 1

Shift the position of the near home input switch in the direction of the home return to the position in the opposite direction.

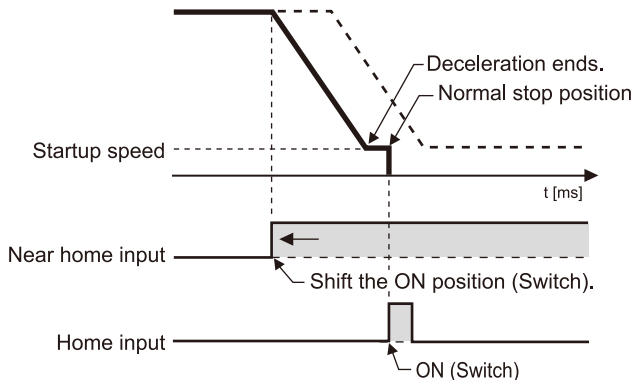

■ Points to check

If the home input is connected to the Z phase of the servo amplifier, there may be cases in which the near home input position is close to the home input.

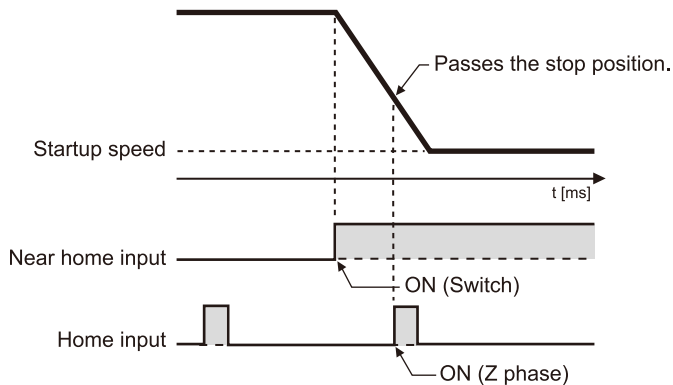

■ Solution 2

Correct the program and set the home return speed to a slower speed.

15.3.7 Speed Does Not Slow Down for a Home Return

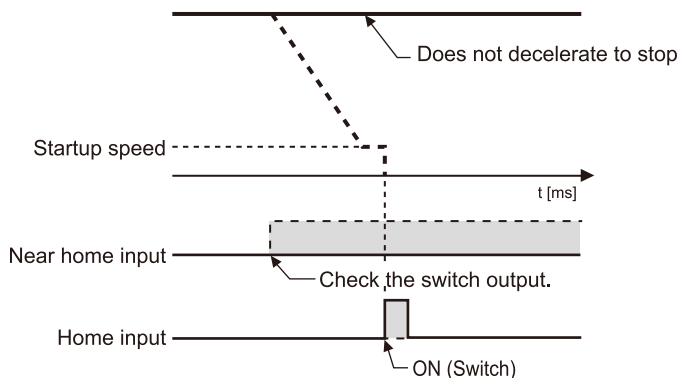

■ Situation

There is a possibility that the near home input has not been read correctly.

■ Solution 1

Forcibly turn the near home input switch ON and OFF from an external source, and check to see if the near home input display LED "D" on the pulse output unit lights.

■ Solution 2

Check to see if the input valid logic for the near home input switch is normally either ON or OFF.

■ Solution 3

- Check the parameter for home return.
- As a default, the near home input is set to "NO contact". When the near home input is not connected, the unit processes as the near home input is invalid.

15.3 What to Do If an Error Occurs

REFERENCE

[4.3 List of Pulse_4Axes Parameters](#)

15.3.8 Movement Does Not Stop at Home Position (after decelerating for home return)

■ Situation

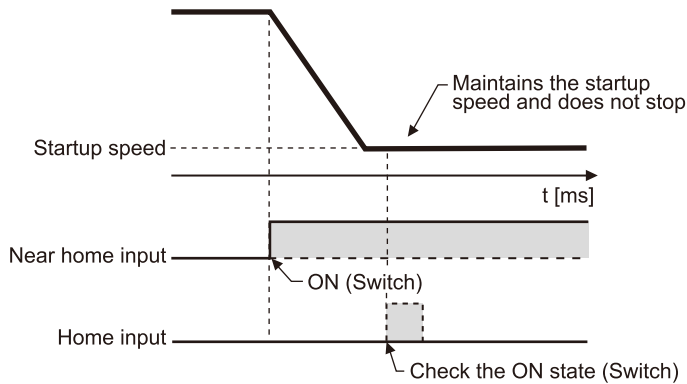

There is a possibility that the PG_Home has not been executed correctly.

■ Solution 1

Forcibly turn the home input sensor ON and OFF from an external source, and check to see if the home input display LED "Z" on the pulse output unit lights.

■ Solution 2

Check to see if the input valid logic for the home input is normally either ON or OFF.

■ Solution 3

- Check the parameter for home return.
- As a default, the home input is set to "NC contact". When the home input is not connected, the unit processes as the home input is invalid.

REFERENCE

[4.3 List of Pulse_4Axes Parameters](#)

16 Specifications

16.1	General Specifications	16-2
16.2	Performance Specifications of the Pulse Output Unit	16-3
16.2.1	Input / Output Specifications	16-4
16.3	Dimensions	16-8
16.3.1	Pulse Output Unit.....	16-8

16.1 General Specifications

16.1 General Specifications

Item	Specifications	
Operating ambient temperature	0°C to +55°C	
Storage ambient temperature	-40°C to +70°C	
Operating ambient humidity	10% to 95% (RH) (at 25°C, no condensation)	
Storage ambient humidity	10% to 95% (RH) (at 25°C, no condensation)	
Withstand voltage	Between external connector terminals and power supply terminals of the GM1 Controller/function earth terminals	500 V AC for 1 minute
Insulation resistance	Between external connector terminals and power supply terminals of the GM1 Controller/function earth terminals	100 MΩ or later
Vibration resistance	Conforming to JIS B 3502 and IEC 61131-2 5 to 8.4 Hz, 3.5-mm single amplitude 8.4 to 150 Hz, acceleration 9.8 m/s ² 10 sweeps each in X, Y and Z directions (1 octave/min)	
Shock resistance	Conforming to JIS B 3502 and IEC 61131-2 147 m/s ² , 3 times each in the X, Y, Z directions	
Noise resistance	1000 V [p-p] with pulse widths of 50 ns/1 μs (by using a noise simulator) (Applied to the power supply of the GM1 Controller)	
Atmosphere	Free of corrosive gases. No excessive dust.	
Overvoltage category	Category II	
Pollution degree	2	

16.2 Performance Specifications of the Pulse Output Unit

■ Performance specifications

Item		Specifications	
Product No.		AGM1PG04T	AGM1PG04L
Output type		Transistor	Line driver
Number of axes controlled		4 axis, independent	
Position command	Command unit	Pulse unit (for increment or absolute)	
	Max. pulse count	Signed 32 bits (-2,147,483,648 to +2,147,483,647 pulses)	
Speed command	Command range	1 pps to 500 kpps (can be set in 1 pps.)	1 pps to 4 Mpps (can be set in 1 pps.)
Acceleration / deceleration command	Acceleration / deceleration method	Linear acceleration / deceleration, S-shaped acceleration / deceleration control	
	S-shape pattern	Can be selected from Sine curve, Cubic curve.	
Home return	Home return speed	Speed setting possible (changes return speed and search speed)	
	Input signal	Home input, near home input, over limit input (+), over limit input (-)	
	Output signal	Deviation counter clear signal	
Operation mode		<ul style="list-style-type: none"> ● E-point control (Linear and S-shaped acceleration / deceleration) ● P-point control (Linear and S-shaped acceleration / deceleration) ● Home return (Home search) ● JOG operation^(Note 1) ● JOG positioning ● Pulser input operation^(Note 2) Transfer multiplication ratio (x1, x2, x5, x10, x50, x100, x500, x1000) ● Real-time frequency change function 	
Startup time		0.001ms / 0.005ms / 0.02ms	
Output interface	Output mode	Pulse / Sign, CW / CCW	
Feedback counter function ^(Note 2)	Counting range	Signed 32 bits (-2,147,483,648 to +2,147,483,647 pulses)	
	Input mode	2-phase input, direction identification input, individual input (transfer multiple available for each mode)	
	Max. counting speed	4 MHz (2-phase input) 1 MHz (Direction distinction input and individual input)	
Other functions		<ul style="list-style-type: none"> ● Built-in over limit input (+) and over limit input (-) ● Servo ON output incorporated 	

(Note 1) When Linear acceleration/deceleration operation is selected, the target speed can be changed during an operation.

(Note 2) "Pulser input operation" and "Feedback counter" use the same pulse input terminal. Either function of the two can only be used.

16.2 Performance Specifications of the Pulse Output Unit

16.2.1 Input / Output Specifications

- The signal pins for two axes are assigned to one connector.
- The connector for 1- and 2-axis has completely the same pin arrangements as the connector for 3- and 4-axis. Therefore, the same pin number functions the same.
- The specifications of the pulse output terminal of the transistor type are different from those of the line driver type. However, the specifications of the input terminal and the power supply terminal are the same for both types.

Output terminals (Transistor output type)

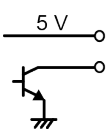
Pin No.		Circuit	Signal name	Output specifications		
Axis 1 / 3	Axis 2 / 4			Item	Description	
A1	A10		A1/A10 A2/A11	Pulse output A: 5 VDC output	Output type	Open collector
B1	B10		B1/B10 B2/B11	Pulse output A: Open collector	Operating voltage range	4.75 to 26.4 V DC
A2	A11		Pulse output B: 5 VDC output	Max. load current	15 mA	
B2	B11		Pulse output B: Open collector	ON state max. voltage drop	0.6 V	

Output terminals (Line driver output type)

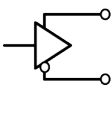
Pin No.		Circuit	Signal name	Output specifications		
Axis 1 / 3	Axis 2 / 4			Item	Description	
A1	A10		A1/A10 A2/A11	Pulse output A: Line driver (+)	Output type	Line driver output Equivalent to AM26C31
B1	B10		B1/B10 B2/B11	Pulse output A: Line driver (-)		
A2	A11		Pulse output B: Line driver (+)			
B2	B11		Pulse output B: Line driver (-)			

Output terminals (common)

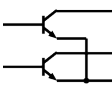
Pin No.		Circuit	Signal name	Output specifications	
Axis 1 / 3	Axis 2 / 4			Item	Description
B5	B14		Servo ON output (+)	Output type	Open collector
				Operating voltage range	4.75 to 26.4 V DC
A7	A16		Deviation counter clear (+)	Max. load current	10 mA

16.2 Performance Specifications of the Pulse Output Unit

Pin No.		Circuit	Signal name	Output specifications	
Axis 1 / 3	Axis 2 / 4			Item	Description
B7	B16		COM	ON state max. voltage drop	1.0 V

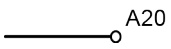
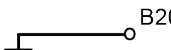

(Note 1) The deviation counter clear signal is output when the power supply is turned ON for about 1 ms. When the home return is complete, the signal is output for about 1 ms or 10 ms. The time can be specified using the "Parameter".

Power supply terminal (common)

Pin No.	Circuit	Signal name	Power supply specifications	
			Item	Description
A20		External power supply input: 24 V DC (+)	Supplied power supply range	21.4 to 26.4 V DC
B20		External power supply input: 24 V DC (-)	Consumption current	90 mA or less

(Note 1) The external power supply input terminals between two connectors are connected internally.

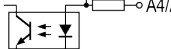
Input terminals (common)

Pin No.		Circuit	Signal name	Input specifications	
Axis 1 / 3	Axis 2 / 4			Item	Description
A3	A12		Home input 24 V DC (+) (Z24)	Operating voltage range	21.6 to 26.4 V DC
				Min. ON voltage / current	19.2 V DC / 5.5 mA
				Max. OFF voltage / current	2 V DC / 2 mA
				Input impedance	Approx. 3.9 kΩ
				Pulse width	100 μs or more
A4	A13		Home input 5 V DC (+) (Z5)	Operating voltage range	3.5 to 5.25 V DC (5 V DC, Line driver specifications)
				Min. ON voltage / current	3 V DC / 4 mA
				Max. OFF voltage / current	1 V DC / 0.5 mA
				Input impedance	Approx. 560 Ω
B3	B12		Home input (-)	-	-

16.2 Performance Specifications of the Pulse Output Unit

Pin No.		Circuit	Signal name	Input specifications	
Axis 1 / 3	Axis 2 / 4			Item	Description
B4	B13		COM	-	-
A5	A14		Near home input (DOG)	Operating voltage range	21.6 to 26.4 V DC
				Min. ON voltage / current	Near home input (DOG) 19.2 V DC / 5.0 mA Over limit input (+) Over limit input (-) Positioning control start input (Timing input) 19.2 V DC / 2.6 mA
				Max. OFF voltage/ current	2 V DC / 1.5 mA
A6	A15	Over limit input (+)	Max. OFF voltage/ current	2 V DC / 1.5 mA	
B6	B15		Over limit input (-)	Input impedance	Near home input (DOG) Approx. 3.6 kΩ Over limit input (+) Over limit input (-) Positioning control start input (Timing input) Approx. 6.8 kΩ
					Positioning control start input (Timing input)
A8	A17		Pulse input A (+)	Operating voltage range	3.5 to 5.25 V DC (5 V DC, Line driver specifications)
B8	B17		Pulse input A (-)	Min. ON voltage / current	3 V DC / 3.2 mA
A9	A18		Pulse input B (+)	Max. OFF voltage/ current	1 V DC / 0.5 mA
B9	B18		Pulse input B (-)	Input impedance	Approx. 560 Ω
		Pulse width		0.5 μs or more (Max. 1 MHz each phase)	

- The pulse input A and B signals should be used within the following specifications.

When using the pulse input A and B signals for 2-phase input method

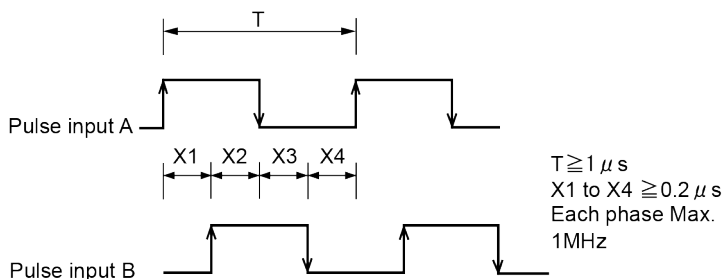

When using the pulse input A and B signals for direction discrimination input method

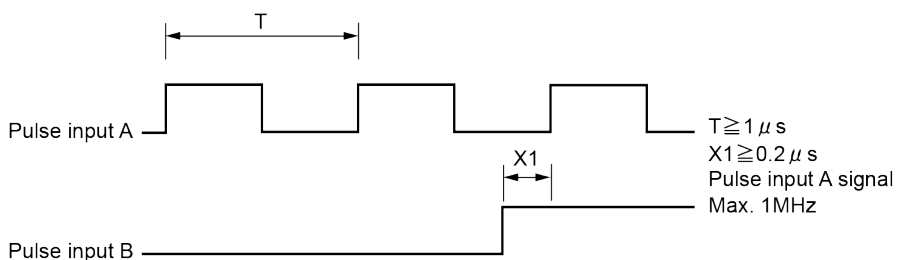

When using the pulse input A and B signals for individual input method

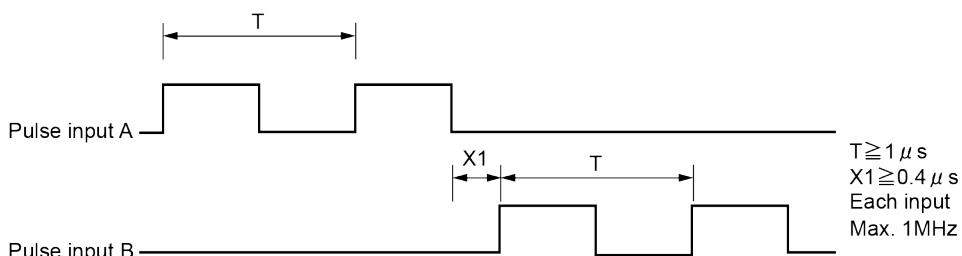

- When the pulse inputs A and B are used as pulser input, it is 2-phase input.

16.3 Dimensions

16.3 Dimensions

16.3.1 Pulse Output Unit

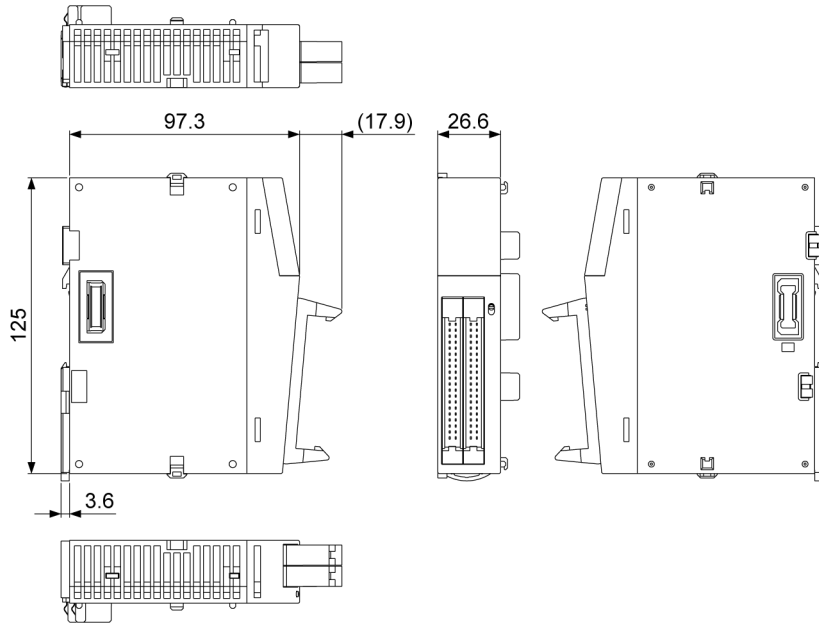

Unit : mm

Appendix Warranty / Cautions for Proper Use

Warranty	App-2
Warranty Period	App-2
Warranty Scope	App-2
Cautions for Proper Use	App-3

Warranty

Warranty Period

The warranty period of the Product shall be 12 months from the ex-factory date or 18 months from the date of manufacturing unless otherwise specified between both parties.

Warranty Scope

Panasonic warrants the replacement of the defected parts of the Product or repair of them when the defects of the Product occur during the Warranty Period, and when the defects are under Panasonic responsibility. This Warranty only covers the Product itself and does not cover any damage to your company and the third party incurred by the Product, such as damage that is induced by an object machined or produced using the Product or by the defects of the Product. This Warranty shall be exempted in the following cases,

1. Defects resulting from misuse and/or repair or modification by the customer.
2. Defects resulting from drop of the Product or damage during transportation.
3. Defects resulting from improper usage of the Product beyond the Specifications.
4. Defects resulting from fire, earthquake, lightening, flood, damage from salt, abnormal voltage or other Act of God, or other disaster.
5. Defects resulting from the intrusion of foreign material to the Product, such as water, oil or metallic particles.
6. Parts exceeding their standard lifetime specified in this document.
7. The machines are not assembled in accordance with the instructions or precautions noted in this specification.
8. When the machine does not match the Product assembled in the machine.
9. When the machine condition is not caused by Panasonic reasons.
10. Defects that Panasonic could not foresee at the time of delivery of the Product.

Cautions for Proper Use

■ Selection of a power supply

- Use a low noise power supply.
- The inherent noise resistance is sufficient for the noise superimposed on the power wires, however, the noise can be attenuated further by using the isolation transformer / insulated power supply.

■ Isolation of power supply systems

- Wiring to the units, I/O devices, and other power devices should have separate wiring systems.

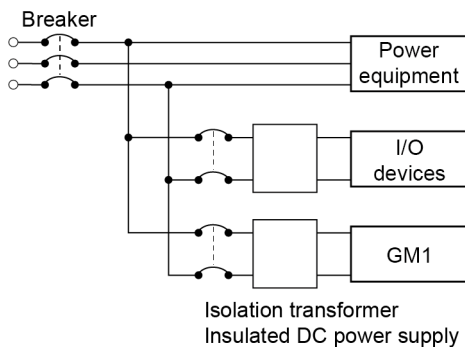

■ Power supply sequence

- Start the GM1 controller only after I/O devices and power devices are energized. In case of stopping the operation of the GM1 controller, have the I/O devices or power devices turned OFF after the GM1 controller has stopped operating.

■ Grounding

- The grounding connection should have a resistance of 100 Ω or less.
- The point of grounding should be as close to the GM1 controller as possible. The ground wire should be as short as possible.
- Sharing the ground with another device may have an adverse effect. Therefore, be sure that grounding is dedicated.

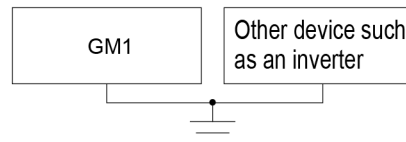
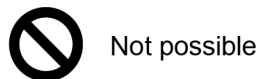
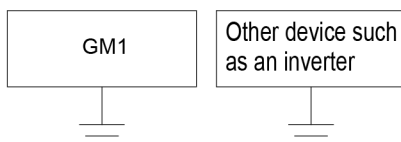

Conversely, depending on your environment, grounding may cause a problem. Do not ground the function earth when grounding a plus (+) terminal of the power.

Cautions for Proper Use

■ Wiring

- Turn OFF the power supply when carry out wiring or connecting the GM1 controller to expansion units.
- Noise resistance measures such as attaching a noise filter, a surge absorber or a ferrite core may be necessary in some cases, depending on the usage environment.

■ Installation of an interlock circuit

- When controlling conflicting operations such as the motor rotation in clockwise or counter-clockwise direction, provide an interlock circuit external to the GM1 controller.

■ Installation of an emergency stop circuit

- Provide an emergency stop circuit external to the GM1 controller to turn OFF the power supply of the output device.

■ Installation environment

Do not use it in the following environments.

- Direct sunlight
- Sudden temperature changes causing condensation.
- Inflammable or corrosive gas.
- Excessive airborne dust, metal particles or saline matter.
- Benzine, paint thinner, alcohol or other organic solvents or strong alkaline solutions such as ammonia or caustic soda.
- Direct vibration, shock or direct drop of water.
- Influence from power transmission lines, high voltage equipment, power cables, power equipment, radio transmitters, or any other equipment that would generate high switching surges. (100 mm or more)

■ Handling instructions

- Before touching the unit, always touch a grounded piece of metal in order to discharge static electricity.
- Always rid yourself of any static electricity before handling this product.
- Do not connect a unit other than our GM1 series to the side connector on the unit.
- Use copper wires with a temperature rating of 90°C or higher.

Record of Changes

Date	Manual No.	Record of changes
August 2021	WUME-GM1PG-01	1st edition
April 2022	WUME-GM1PG-02	2nd edition <ul style="list-style-type: none">• Changed the Company name• Added function block argument for pulse output unit<ul style="list-style-type: none">• Added switching of P-point / E-point control for positioning control• Added the creep speed of home return
June 2022	WUME-GM1PG-03	3rd edition <ul style="list-style-type: none">• Clerical corrections
August 2023	WUME-GM1PG-04	4th edition <ul style="list-style-type: none">• Clerical corrections

(MEMO)

(MEMO)

Please contact

**Industrial Device Business Division,
Panasonic Industry Co., Ltd.**

7-1-1 Morofuku, Daito City, Osaka, 574-0044, Japan
industrial.panasonic.com/ac/e/

© Panasonic Industry Co., Ltd 2021-2023

WUME-GM1PG-04